

Leading the Future in Refrigeration Technology



**EMERSON**  
**ZX Platform Condensing Unit**  
**PRODUCT MANUAL**



EMERSON. CONSIDER IT SOLVED.™

<b>The Emerson ZX platform condensing unit</b>	<b>1</b>
<b>ZX – reliability platform</b>	<b>2</b>
<b>ZX – performance platform</b>	<b>2</b>
<b>ZX – design platform</b>	<b>2</b>
<b>Emerson ZX platform – scroll superiority</b>	<b>3</b>
<b>Physical layout of the ZX platform CDU</b>	<b>4</b>
<b>ZX Platform E2 control features</b>	<b>7</b>
<b>ZX platform- technical specifications</b>	
<b>Nomenclature</b>	<b>10</b>
<b>Bill of material (BOM)</b>	<b>10</b>
<b>Envelope</b>	<b>11</b>
<b>Performance tables</b>	
ZX MT unit capacity and power at 50Hz for refrigerant R22	12
ZX MT unit capacity and power at 50Hz for refrigerant R404a	13
ZX LT unit capacity and power at 50Hz for refrigerant R22	14
ZX LT unit capacity and power at 50Hz for refrigerant R404a	15
<b>ZX LT unit (liquid line temperature)</b>	<b>16</b>
<b>Wiring diagram (ZX MT &amp; LT units)</b>	<b>17</b>
<b>Technical data</b>	
ZX MT units	18
ZX LT units	19
<b>Dimensional drawing (ZX MT &amp; LT units)</b>	<b>20</b>
<b>Diagnostic messaging – LED definitions (ZX MT and LT units)</b>	<b>21</b>
<b>Diagnostic initialization message (ZX MT and LT units)</b>	<b>22</b>
<b>E2 control board dip switch setting</b>	<b>22</b>
<b>E2 controller trip set-points &amp; actions (ZX MT &amp; LT units)</b>	<b>24</b>
<b>Vapor injection: specific application tips - ZX LT CDU</b>	<b>25</b>

## The Emerson ZX platform condensing units

Emerson Climate Technologies is pleased to offer the ZX platform refrigeration condensing units (CDU) specifically designed for medium temperature (MT) and low temperature (LT) refrigeration. Emerson's CDU range comes with unique features and applies its advanced and patented scroll technologies that redefine the standards of efficiency and reliability for this category of products.

ZX MT series CDU has been highly successful in the Asian market and enjoys proven success with its energy savings and customer-friendly electronic features. ZX MT CDU's have been applied by several well known end-users and chain retailers throughout Asia. The ZX platform is also gaining wider acceptance in the global market and specific variants have been developed and exported to the USA, European and Middle East markets.

The ZX platform CDUs come with Emerson Climate Technologies' highly successful "E2 Controller". E2 controller provides real-time monitoring of compressor operating conditions and initiates actions to keep the compressor within the safe zone. When fault conditions are detected, the controller initiates temporary shutdowns and sends specific warning signals to facilitate service. In the event of continued errors, the controller will shutdown the unit thereby preventing costly equipment failure and send alarm signals. The controller is also designed to activate an external telephone dialer to be notified on a preset telephone number. This feature can also be used to automatically start a back-up unit in critical applications.

Emerson's highly successful Copeland® brand scroll compressors drive the high efficiency of the ZX platform of CDUs. Over 50 millions Copeland® brand scroll compressors sold across the globe stand testimony to the extraordinary confidence and success in our scroll technology.

However, we have not rested on these laurels alone when it comes to our ZX platform CDUs.

The ZX range of MT CDUs benefits from patented scroll suction injection technology. This allows the scroll compressor to provide a superior MT envelope.

ZX LT CDU applies vapor injection technology. This allows an economizer cycle on scroll compressors. Vapor injection significantly improves the LT operational efficiency and extends the LT envelope.

Emerson Climate Technologies continues to focus on the ZX CDU platform to develop discernibly superior solutions for the demanding refrigeration market.

## ZX – reliability platform

Emerson Climate Technologies has designed the ZX platform CDUs with extended operational capability in tough climatic conditions. With our vast experience in the refrigeration industry, ZX platform CDU is designed with a good protection scheme. ZX protection scheme detect conditions that could cause damage to the compressor, initiates a warning, temporary shutdown and auto restarts. The control system will allow a complete shutdown requiring manual restart only after several iterations of repeated warnings and temporary shutdowns are carried out. The control system is driven by the built-in “E2 Controller”. Figure 01 shows the control strategy of the E2 Controller in a schematic form.

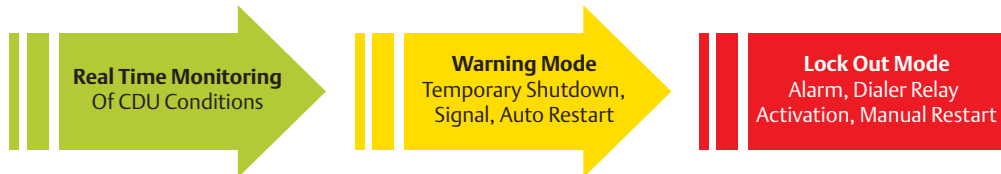

Figure 01

## ZX – performance platform

Emerson Climate technologies with its leadership in scroll compression technology, apply the most advanced techniques to maximize the possible operational efficiency at specific application envelopes.

ZX MT CDU applies a patented suction-line injection technology. Scroll compressor inherently operates at higher efficiency at MT application conditions. The suction-line injection provides a more reliable MT operating envelope. ZX MT CDU applies ZX series scroll compressor with liquid injection into the suction-line using an electronic expansion valve (EXV). The EXV maintains an optimum feed of partially vaporized liquid refrigerant in the compressor suction to maintain a safe discharge gas temperature. The controlled discharge gas temperature provides a more reliable solution for the MT envelope.

ZX LT CDU applies vapor injection technology to achieve higher efficiency in LT refrigeration. Vapor injection allows an economizer cycle to be applied on a scroll compressor thereby greatly enhancing compressor efficiency. This technology can be likened to 2- stage compression with economizer cycle. Vapor injection improves efficiency by as much as 12% over a liquid injection system of the same type. ZX LT CDU applies ZXI series vapor injected compressor with vapor injection plate heat exchanger (PHE) to implement the vapor injection technology.

## ZX – design platform

The ZX platform CDU’s are designed to provide best operational cost savings on year around basis. Refrigeration equipments operate continuously all 7 days, 24 hours and 365 days. The ZX and ZXI compressors, injection scheme and heat exchanger designs are optimized to provide best efficiencies at annual averaged temperature rather than at the typical rating conditions. The typical ambient on an annual basis follows a normal distribution pattern. The highest and lowest ambient happens only for few hours as shown in figure 02.

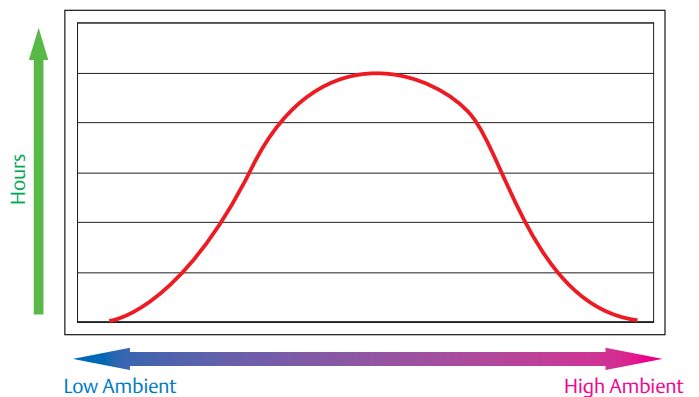

Figure 02



## Emerson ZX platform – scroll superiority

Scroll compressors deliver flatter capacity compared to reciprocating compressor condensing units due to the high volumetric efficiency of scroll compressors.

Flatter capacity can be otherwise described as lower change in capacity with change in outdoor ambient. This is schematically shown in figure 03. Flatter capacity brings certain inherent advantages, which highly benefit users, trade and stored products.

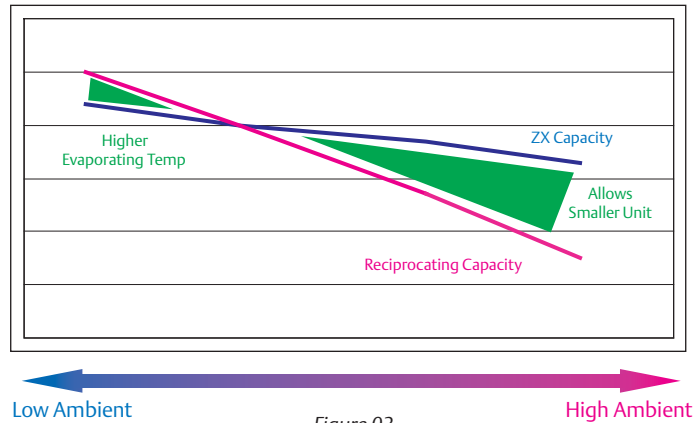

Some of the benefits of flatter capacity on ZX platform CDUs are described below.

- 1. Smaller unit selection:** Condensing units are selected to match the required refrigeration capacity at the highest required ambient. Flatter capacity allows a smaller unit selection compared to reciprocating compressor CDU.
- 2. Lower operating cost:** At lower ambient conditions, ZX platform CDU delivers capacity closer to the cooling load. In contrast reciprocating compressor CDU delivers capacity in far excess of what is required. This helps the ZX platform CDU to operate at relatively higher evaporating temperature. Higher evaporating temperatures improve the compressor efficiency. In addition higher evaporating temperature reduces the rate of ice formation on the evaporator coils /frost build up. Lower frost build-up improves the evaporator heat exchange efficiency. It also reduces the defrost heat demand, thereby resulting in lowering energy needed for defrost.
- 3. Freshness of food:** Another benefit of higher evaporating temperature is reduced dehumidification by the evaporator coil. This allows higher relative humidity in the cold room or cold cases. Higher relative humidity reduce the weight shrinkage and improves freshness of stored product.

## Physical layout of the ZX platform CDU

The unique features of Emerson's ZX platform CDU as described above are quite different from the conventional CDUs available in the market. Apart from this, ZX platform CDU also comes with a package of other conventional features which are part of a well designed condensing unit.

Figure 04 identifies the E2 Control and suction injection assembly layout on a ZX MT CDU. Figure 05 identifies the E2 control and vapor injection assembly on ZX LT CDU.

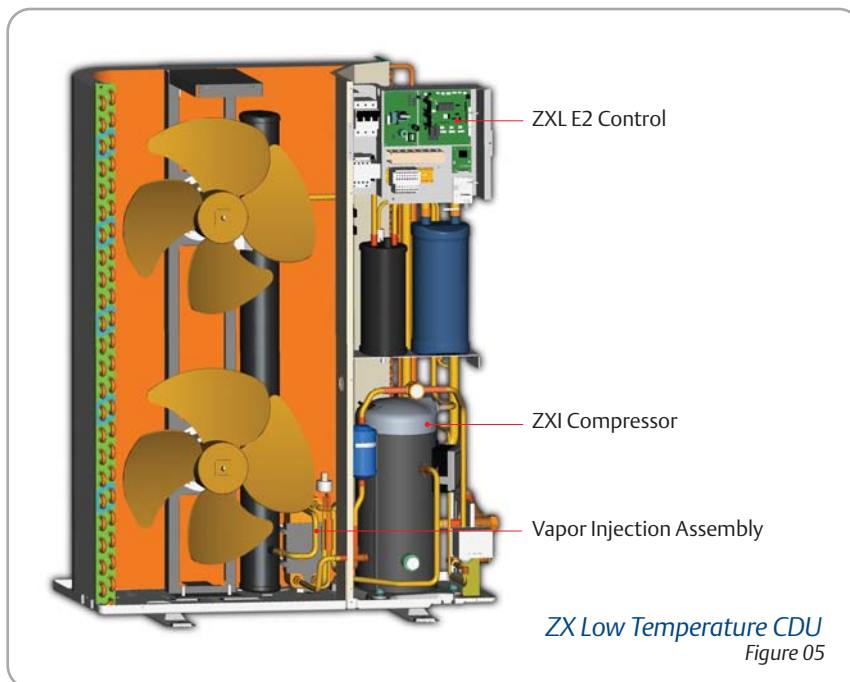
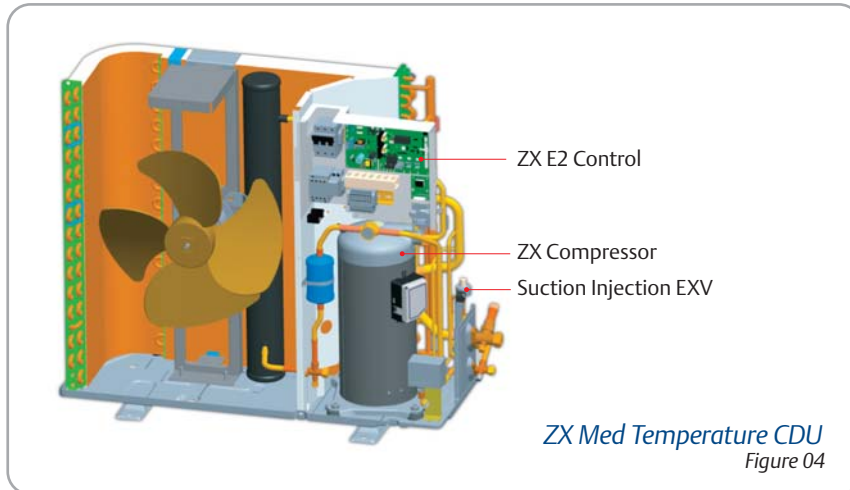

In ZX MT units, suction line injection is applied to the compressor suction. Suction line injection allows a reliable and efficient MT envelope of up to -15 deg C (R22) and -20 deg C (R404A) evaporating temperature. In suction line injection, a part of liquid refrigerant is added into the compressor suction gas. Suction injection de-superheats the suction gas and controls the compressor discharge temperature. This is implemented through electronic control by the E2 controller and an electronic expansion valve (EXV). The E2 monitors the compressor discharge temperature and optimizes the opening of the EXV for optimal discharge gas control.

In ZX LT units, vapor Injection is applied to the compressor. Vapor injection enhances the compressor efficiency by applying 2-stage compression with an economizer refrigeration cycle. Vapor injection eliminates the need for liquid injection, which would otherwise have been required to operate a reliable LT envelope down to -40 deg C evaporating temperature. In vapor injection, a part of liquid refrigerant is expanded and passed through a heat exchanger. In the heat exchanger, this expanded refrigerant absorbs heat from the main liquid line and sub-cool the main liquid. The expanded refrigerant vaporizes while passing through the heat exchanger and is supplied back into the scroll intermediate pockets through the vapor-injection tube. The sub-cooling of the main liquid increases the compressor capacity by as much as 30%. The figure 06 below identifies the key components of the vapor injection assembly.

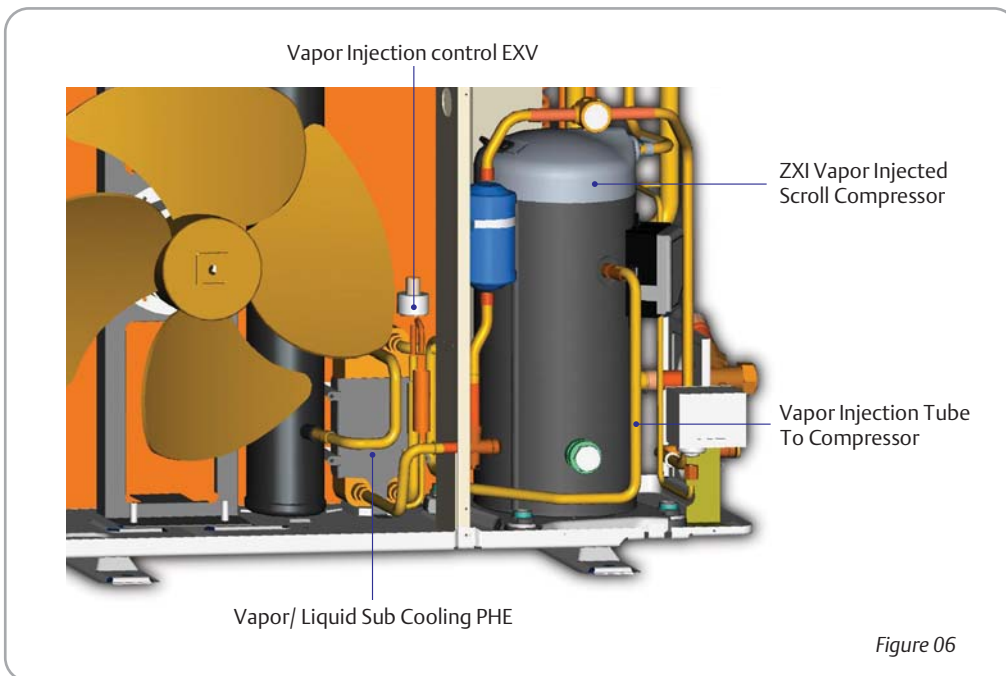

Figure 06

Figure 07 identifies the key components layout of the E2 Control and Electrical components layout

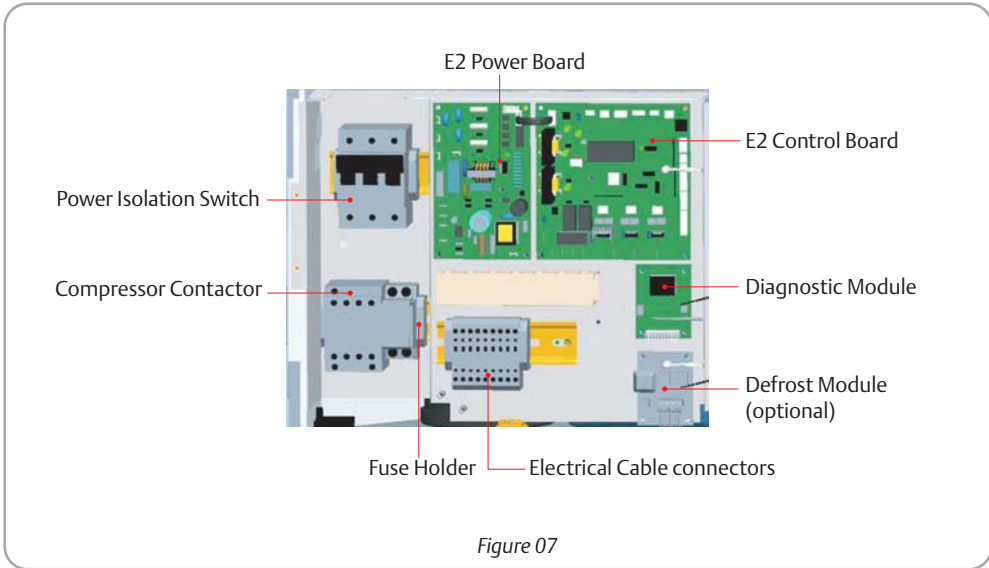

Figure 07

Figure 08 identifies other major refrigerant components layout on a ZX platform CDU

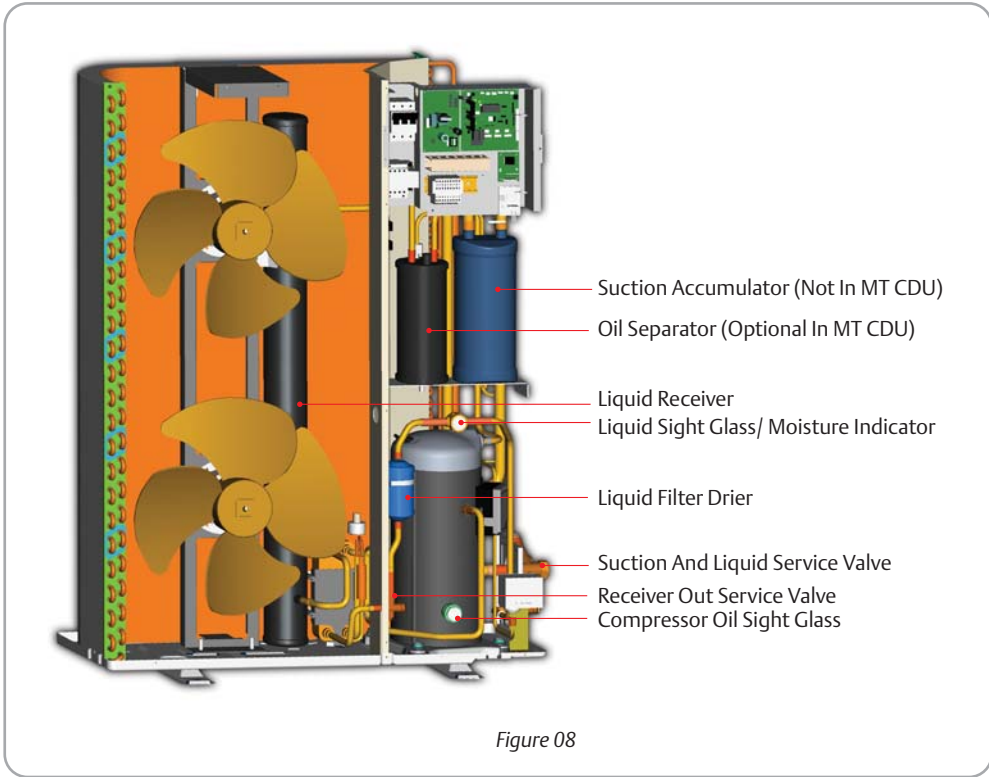

Figure 08



## ZX Platform E2 control features

ZX platform E2 control offers multiple features which are unique to refrigeration condensing units. E2 real-time control monitors and optimizes the suction or vapor injection performance to offer efficient performance in ZX MT and LT units. E2 also monitors the compressor operating parameters, so as to protect the system from unsafe operating parameters such as passing through a peak temperature hour of a peak ambient day; or drop-out of a power-phase; or continued refrigerant loss in the system. E2 controller detects these situations and, as a first step, will initiate some corrective actions.

For example, when the LT unit experiences an extreme temperature day, E2 control decides to switch from vapor-injection-optimization to discharge-gas temperature-control to allow the compressor to run safely and pass the extreme weather hours.

Another fault condition which is common in refrigeration systems is compressor overload. If the condenser coils are not cleaned regularly, the compressor operating discharge pressures rises. This condition is gradual and in conventional CDU's, no advance warning is provided to the user on this approaching undesirable situation. Ultimately, in such a situation, the internal protector in the compressor trips. Two problems arise due to internal protector-trip. First: there is no alarm to detect the trip and second: a compressor internal protector reset may take as long as an hour. This could be critical for quality of frozen food in freezers or cases. On the other hand, ZX E2 controller detects the overload externally and actions a temporary shutdown. E2 Diagnostics will then start transmitting a fault signal. After multiple attempts, and if the error repeats itself as high as six times within an hour, the E2 will finally shutdown the unit to avoid expensive compressor failure.

The E2 will activate a buzzer to send an alarm signal at unit-lockout which then requires a manual restart. The buzzer is a standard part for the ZX platform Gold version CDU. The buzzer can be remotely mounted and has volume and mute capability. The E2 is also designed to activate an externally connected telephone dialer to send fault notice on a preset telephone number.

ZX platform units are designed to operate under extreme ambient temperatures of up to 48 deg C. This extremely high-ambient envelope, combined with the intelligent E2 controller, provides unparalleled benefits to customers.

Figure 09 shows the ZX platform E2 controller and figure 10 shows the ZX platform diagnostics with the buzzer module.



E2 Power Board

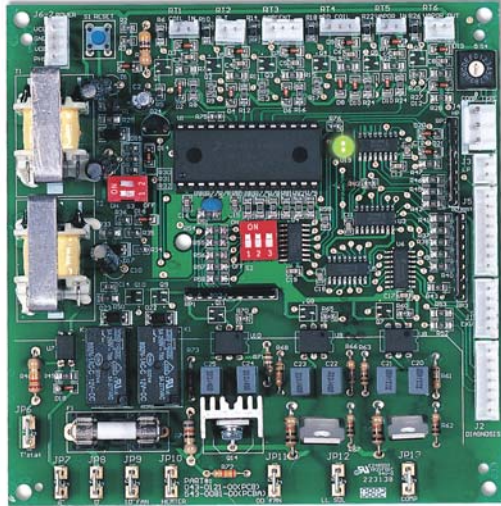

E2 Control Board

Figure 09



E2 Display Diagnostic

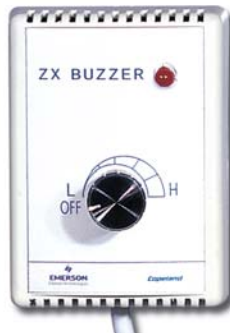

Remote Buzzer  
With Volume

Figure 10

The E2 controller consists of 2 electronic board assemblies: E2 power board and control board. The power board supplies constant DC power to the E2 control board. The E2 control board carries the intelligent chip containing the canned programs. The entire assembly is pre-installed and wired in the factory on a new unit. Both electronic boards carry a LED light (refer fig 9 in which the LED on both boards are identified). If the LED lights are on after power-up of the unit, it indicates normal and proper operation of the electronic boards. Once these lights are on, the rest of the unit including the compressor is monitored and digital messages are shown on the diagnostic panel.

Table 01 shows a list of fault detections enabled by E2 controller and diagnostics on ZX platform CDU. The diagnostics are standard features on the Emerson ZX platform Gold version.

The table 02 summarizes fault conditions under which the E2 controller initiates “temporary shutdown—with-auto-restart” and “lock-out trip-condition with- manual-restart”

E2 Fault Detection Items
• Compressor Phase Reversal
• Loss Of Phase (In 3 Phase Models)
• Compressor Over Current
• Compressor Protector Trip Detection
• Discharge Gas Temperature Over Heat
• High Pressure Cut Out
• Low Pressure Cut Out (MT CDU Only)
• Excessive Refrigerant Flood Back
• Compressor Minimum Off Time
• E2 Sensor Failures

Table 01

Fault	Temporary Shutdown/ Auto Restart	Lock Out Errors/ Manual Restarts
Phase Reversal/ Loss Of Phase		Incorrect 3 Phase Sequence
High Pressure Trip	< 5 Trips In 1 Hour	6 <sup>th</sup> Trip Within 1 Hour
Low Pressure Trip (only on MT Units)	At Every LP Trip	No Lock Out
Discharge Gas Temperature Overheat	< 5 Trips In 1 hour	6 <sup>th</sup> Trip Within 1 Hour
Compressor Over Current	< 5 Trips In 1 Hour	6 <sup>th</sup> Trip Within 1 Hour
Compressor Short Cycling	3 Minutes Between Starts	No Lock Out
Excessive Suction Flood Back	~ 20% Flood Back, Warning Only	No Lock Out
Discharge Sensor Failure (only on LT Units)	< 5 Trips In 1 Hour	6 <sup>th</sup> Trip Within 1 Hour
Other Thermal Sensor Failures	Warning Only	No Lock Out

Table 02

The E2 control is also designed to apply a ZX defrost (DF) module. The ZX DF module is a basic time initiated DF module. The defrost module is supplied as an optional accessory. The DF module has two rotary switches by which the user can set up the defrost duration and defrost interval. The DF module also enables a manual defrost as an override to the rotary switch setting of defrost interval. Figure 11 shows the defrost module

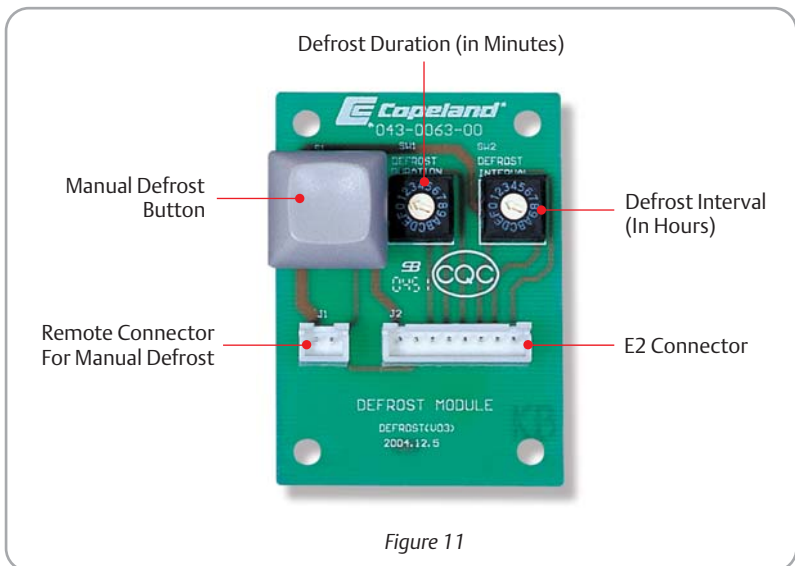
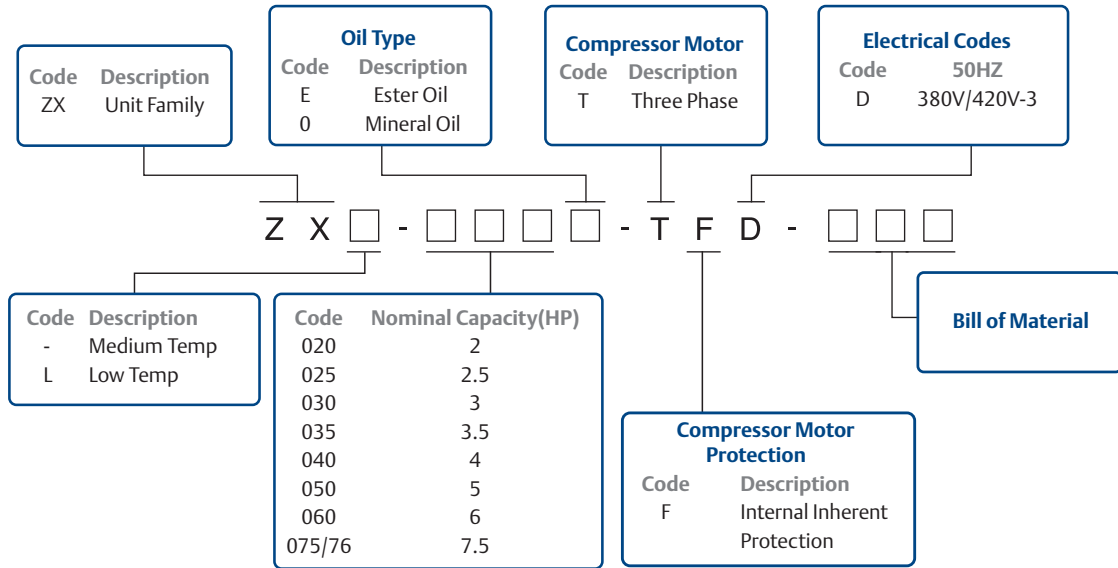

Figure 11

## ZX platform- technical specifications

### Nomenclature



### Bill Of Material (BOM)

ZX Medium Temperature	Silver				Gold			
BOM Number	300	350	301	351	400	450	401	451
Liquid Line Filter Dryer/Sight Glass								
Oil Separator								
Adjustable LP Switch								
Fan Speed Controller								
Diagnostic Module								
Buzzer								
Circuit Breaker								
Sound Jacket								
Defrost Module	ACC	ACC	ACC	ACC	ACC	ACC	ACC	ACC

ZX Low Temperature	Gold	
BOM Number	450	451
Liquid Line Filter Dryer/Sight Glass		
Oil Separator		
Adjustable LP Switch		
Fan Speed Controller		
Diagnostic Module		
Buzzer		
Circuit Breaker		
Sound Jacket		
Defrost Module	ACC	ACC

**Note:** Acc=Accessory



## Envelope

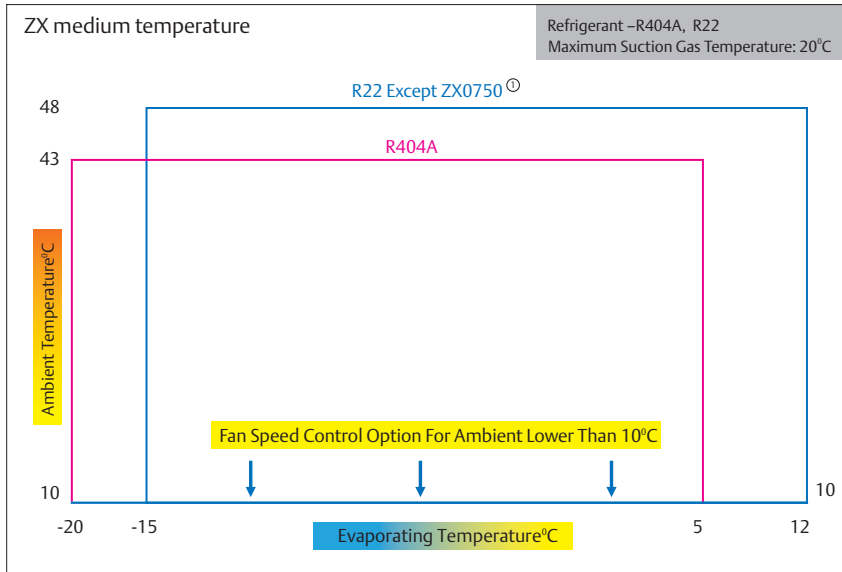

Note<sup>Ⓞ</sup>: For model ZX0750 Max Amb: 43°C, Max Evap: 5°C

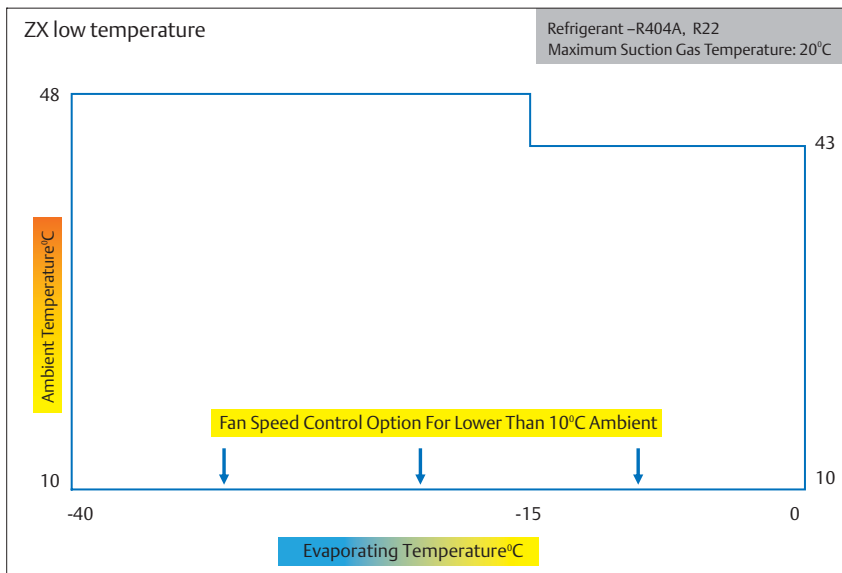

## Performance Tables



**ZX MT Unit Capacity And Power (kW) At 50Hz For Refrigerant R22**

Model	Ambient Temperature (°C)	Capacity							Power						
		Evaporating Temperature (°C)							Evaporating Temperature (°C)						
		-15	-10	-5	0	5	10	12	-15	-10	-5	0	5	10	12
ZX0200	27	2.84	3.61	4.18	4.95	5.87	7.03	7.45	1.33	1.37	1.41	1.47	1.53	1.70	1.79
	32	2.65	3.33	4.01	4.75	5.61	6.54	6.96	1.45	1.50	1.58	1.64	1.71	1.84	1.88
	38	2.38	3.11	3.81	4.55	5.37	6.19	6.68	1.62	1.74	1.83	1.87	1.91	2.03	2.08
	43	1.93	2.74	3.48	4.23	5.06	5.99	6.33	1.78	1.83	1.95	2.05	2.11	2.20	2.25
	48	1.68	2.30	3.18	3.87	4.69	5.51	5.80	2.21	2.31	2.44	2.51	2.54	2.55	2.64
ZX0300	27	4.30	5.20	6.28	7.57	9.09	10.22	10.80	1.95	2.04	2.17	2.20	2.23	2.43	2.49
	32	4.12	4.90	5.95	7.28	8.69	9.79	10.31	2.10	2.20	2.32	2.34	2.46	2.70	2.77
	38	3.68	4.62	5.65	6.85	8.29	9.06	9.63	2.37	2.48	2.59	2.60	2.76	3.06	3.12
	43	3.27	4.22	5.27	6.50	7.97	8.63	9.08	2.64	2.75	2.84	2.94	3.04	3.32	3.36
	48	2.40	3.55	4.65	5.67	6.86	7.97	8.50	2.98	3.18	3.28	3.35	3.50	3.64	3.69
ZX0400	27	5.98	7.20	8.57	10.03	11.54	13.82	14.64	2.64	2.71	2.83	2.98	3.08	3.34	3.36
	32	5.46	6.73	8.13	9.62	11.16	13.01	13.85	2.81	2.90	3.06	3.19	3.33	3.68	3.68
	38	4.72	6.01	7.42	8.93	10.48	12.09	13.04	3.08	3.27	3.39	3.49	3.65	4.09	4.07
	43	4.09	5.37	6.78	8.27	9.80	11.61	12.25	3.29	3.52	3.68	3.80	3.95	4.38	4.39
	48	3.55	4.50	6.20	7.57	9.08	10.68	11.23	4.16	4.46	4.49	4.72	4.80	5.07	5.18
ZX0500	27	7.13	8.76	10.44	12.22	14.12	17.28	18.22	2.88	3.03	3.18	3.29	3.47	4.16	4.28
	32	6.77	8.31	9.96	11.72	13.68	16.62	17.47	3.37	3.35	3.57	3.67	3.97	4.50	4.58
	38	6.24	7.69	9.28	11.06	13.06	15.31	16.34	3.77	3.87	4.07	4.27	4.47	4.98	5.10
	43	5.44	6.80	8.36	10.15	12.21	14.60	15.47	4.27	4.27	4.47	4.66	4.96	5.46	5.56
	48	3.96	5.80	7.62	9.49	11.47	13.49	14.40	5.14	5.21	5.44	5.61	5.80	6.01	6.04
ZX0600	27	8.50	10.41	12.49	14.72	17.66	19.64	20.60	3.51	3.70	3.88	4.16	4.43	4.98	5.32
	32	7.71	9.93	11.71	13.94	16.30	18.87	20.10	3.88	4.07	4.25	4.43	4.71	5.29	5.47
	38	6.81	8.42	10.57	12.85	15.26	17.77	18.92	4.34	4.53	4.71	4.90	5.08	5.86	5.98
	43	5.91	7.23	9.40	11.78	14.26	16.33	17.86	4.90	5.17	5.45	5.64	5.73	6.57	6.66
	48	4.97	7.00	9.25	11.15	13.08	15.09	16.06	6.02	6.22	6.46	6.69	6.96	7.22	7.45
ZX0750	27	10.03	12.20	14.41	17.23	20.87			4.34	4.54	4.76	4.98	5.22		
	32	9.45	11.24	13.90	16.63	20.21			4.77	4.95	5.19	5.51	5.91		
	38	8.83	10.85	13.25	15.50	19.42			5.36	5.53	5.83	6.25	6.80		
	43	8.18	10.00	12.29	14.30	18.49			5.95	6.10	6.43	6.93	7.62		
ZX0760	27	10.23	12.44	14.70	17.60	21.29	25.49	27.01	4.25	4.45	4.66	4.88	5.12	5.47	5.64
	32	9.64	11.46	14.18	16.96	20.61	24.03	25.58	4.67	4.85	5.09	5.40	5.79	5.86	5.97
	38	9.01	11.07	13.52	15.80	19.81	22.85	24.65	5.26	5.42	5.72	6.12	6.67	6.64	6.81
	43	8.34	10.20	12.54	14.60	18.86	22.34	23.57	5.83	5.98	6.30	6.79	7.47	7.34	7.48
	48	7.24	8.55	11.46	14.09	17.47	20.55	21.61	6.79	7.04	7.40	7.89	8.43	8.74	8.78

**Note:** Based on the return gas temperature of 18.3°C, Power include condenser fan.  
Shaded ambient data are typical design conditions for unit selection.



## Performance Tables

# R404A

ZX MT Unit Capacity And Power (kW) At 50Hz For Refrigerant R404a

Model	Ambient Temperature (°C)	Capacity						Power					
		Evaporating Temperature (°C)						Evaporating Temperature (°C)					
		-20	-15	-10	-5	0	5	-20	-15	-10	-5	0	5
ZX020E	27	3.30	3.90	4.44	5.08	5.79	6.60	1.64	1.67	1.70	1.76	1.84	1.96
	32	2.85	3.39	3.92	4.48	5.08	5.76	1.79	1.81	1.84	1.90	2.00	2.12
	38	2.42	2.90	3.36	3.85	4.36	4.94	1.95	1.99	2.02	2.07	2.16	2.26
	43	1.94	2.43	2.89	3.34	3.81	4.30	2.14	2.18	2.22	2.27	2.34	2.41
ZX030E	27	4.04	4.87	5.81	6.85	7.99	9.23	2.14	2.19	2.24	2.32	2.42	2.55
	32	3.75	4.52	5.39	6.35	7.40	8.55	2.40	2.44	2.50	2.57	2.67	2.81
	38	3.39	4.08	4.85	5.72	6.67	7.69	2.72	2.75	2.80	2.88	3.00	3.15
	43	3.06	3.69	4.39	5.17	6.03	6.97	3.06	3.09	3.14	3.21	3.33	3.50
ZX040E	27	5.52	6.57	7.70	8.95	10.37	12.02	2.72	2.86	3.02	3.17	3.31	3.36
	32	5.10	6.10	7.13	8.24	9.47	10.87	3.03	3.15	3.31	3.46	3.54	3.68
	38	4.61	5.60	6.57	7.57	8.64	9.85	3.45	3.58	3.71	3.85	3.97	4.03
	43	3.98	5.00	5.95	6.89	7.83	8.85	3.87	4.00	4.12	4.23	4.33	4.38
ZX050E	27	7.49	9.05	10.67	12.31	13.93	15.51	3.65	3.73	3.86	4.02	4.25	4.53
	32	6.56	8.12	9.76	11.43	13.10	14.74	4.11	4.20	4.32	4.50	4.72	5.00
	38	5.56	7.07	8.67	10.32	11.98	13.63	4.59	4.68	4.79	4.96	5.16	5.42
	43	4.88	6.28	7.79	9.37	10.98	12.58	5.11	5.17	5.27	5.40	5.59	5.81
ZX060E	27	8.24	9.72	11.47	13.30	15.69	18.48	3.69	3.84	4.06	4.33	4.62	4.93
	32	7.53	9.06	10.72	12.58	14.72	17.20	4.40	4.54	4.75	5.01	5.28	5.56
	38	6.74	8.25	9.83	11.55	13.48	15.69	4.93	5.05	5.25	5.47	5.72	5.98
	43	5.90	7.48	9.07	10.74	12.57	14.63	5.59	5.69	5.85	6.06	6.28	6.51
ZX075E	27	9.04	10.86	12.75	15.07	17.76	20.13	4.08	4.26	4.50	4.80	5.13	5.46
	32	8.33	10.01	11.82	13.86	16.20	18.92	4.88	5.03	5.27	5.54	5.86	6.17
	38	7.30	8.74	10.62	12.47	14.54	16.92	5.46	5.61	5.82	6.06	6.35	6.63
	43	6.26	7.93	9.61	11.38	13.32	15.50	6.20	6.32	6.49	6.71	6.96	7.22
ZX076E	27	9.22	11.07	13.00	15.37	18.12	20.53	4.00	4.17	4.41	4.70	5.03	5.35
	32	8.50	10.21	12.06	14.14	16.53	19.30	4.78	4.93	5.16	5.43	5.74	6.05
	38	7.45	8.91	10.83	12.72	14.83	17.26	5.35	5.50	5.70	5.94	6.22	6.50
	43	6.39	8.09	9.80	11.61	13.59	15.81	6.07	6.19	6.36	6.57	6.82	7.07

**Note:** Based on the return gas temperature of 18.3°C, Power include condenser fan.  
Shaded ambient data are typical design conditions for unit selection.

# Performance Tables



ZXL Unit Capacity And Power (kW) At 50Hz For Refrigerant R22

Model	Ambient Temperature (°C)	Capacity									Power								
		Evaporating Temperature (°C)									Evaporating Temperature (°C)								
		-40	-35	-30	-25	-20	-15	-10	-5	0	-40	-35	-30	-25	-20	-15	-10	-5	0
ZXL0200	20	1.35	1.57	1.90	2.28	2.76	3.30	3.93	4.64	5.41	0.94	1.03	1.12	1.19	1.26	1.31	1.36	1.40	1.43
	27	1.32	1.55	1.87	2.26	2.73	3.27	3.89	4.59	5.36	1.10	1.20	1.29	1.36	1.43	1.49	1.55	1.59	1.63
	32	1.32	1.55	1.86	2.24	2.70	3.24	3.85	4.54	5.31	1.26	1.36	1.45	1.53	1.61	1.67	1.73	1.78	1.81
	38	1.26	1.48	1.78	2.15	2.61	3.13	3.74	4.42	5.18	1.51	1.61	1.71	1.79	1.87	1.94	2.00	2.05	2.09
	43	1.15	1.36	1.66	2.03	2.47	2.99	3.59	4.27	5.02	1.76	1.87	1.97	2.05	2.13	2.21	2.27	2.32	2.37
	48	0.99	1.20	1.49	1.85	2.29	2.81				2.05	2.16	2.26	2.35	2.44	2.51			
ZXL0250	20	1.65	1.90	2.20	2.70	3.40	4.10	4.85	5.73	6.72	1.18	1.28	1.38	1.48	1.57	1.65	1.74	1.81	1.89
	27	1.61	1.87	2.12	2.67	3.31	4.03	4.84	5.72	6.69	1.32	1.40	1.49	1.57	1.64	1.71	1.78	1.84	1.90
	32	1.56	1.82	2.09	2.63	3.26	3.97	4.76	5.63	6.58	1.51	1.59	1.66	1.72	1.79	1.85	1.90	1.95	2.00
	38	1.42	1.68	1.97	2.49	3.10	3.79	4.56	5.42	6.36	1.85	1.91	1.97	2.02	2.07	2.11	2.15	2.19	2.22
	43	1.23	1.48	1.79	2.30	2.89	3.57	4.33	5.17	6.09	2.22	2.27	2.31	2.35	2.39	2.43	2.45	2.48	2.50
	48	1.10	1.28	1.54	2.03	2.61	3.27				2.66	2.70	2.74	2.77	2.79	2.82			
ZXL0300	20	1.94	2.29	2.67	3.17	3.78	4.48	5.40	6.52	8.06	1.28	1.45	1.60	1.74	1.87	1.99	2.09	2.18	2.26
	27	1.90	2.19	2.58	3.08	3.69	4.40	5.20	6.44	7.85	1.36	1.52	1.67	1.80	1.92	2.03	2.13	2.21	2.28
	32	1.80	2.09	2.49	2.99	3.60	4.32	5.14	6.06	7.63	1.55	1.70	1.85	1.98	2.09	2.20	2.29	2.37	2.43
	38	1.58	1.87	2.27	2.77	3.39	4.10	4.92	5.85	7.30	1.92	2.07	2.21	2.33	2.45	2.54	2.63	2.70	2.76
	43	1.31	1.59	1.99	2.50	3.11	3.83	4.65	5.58	6.95	2.36	2.51	2.64	2.76	2.86	2.96	3.04	3.11	3.16
	48	1.21	1.35	1.63	2.13	2.75	3.47				2.91	3.05	3.18	3.29	3.39	3.48			
ZXL0350	20	2.56	2.90	3.44	4.15	5.01	5.98	7.03	8.14	9.26	1.68	1.73	1.79	1.88	1.98	2.09	2.22	2.37	2.52
	27	2.29	2.64	3.19	3.91	4.76	5.71	6.75	7.83	8.92	1.81	1.87	1.95	2.05	2.17	2.30	2.44	2.60	2.76
	32	2.12	2.47	3.02	3.72	4.56	5.49	6.50	7.55	8.62	2.08	2.16	2.25	2.36	2.48	2.62	2.78	2.94	3.11
	38	1.93	2.27	2.80	3.48	4.28	5.19	6.16	7.16	8.18	2.52	2.60	2.71	2.82	2.96	3.11	3.27	3.44	3.63
	43	1.78	2.09	2.59	3.25	4.02	4.89	5.81	6.77	7.73	2.88	2.97	3.09	3.21	3.35	3.51	3.68	3.86	4.05
	48	1.61	1.90	2.37	2.98	3.71	4.53				3.18	3.28	3.40	3.53	3.68	3.84			
ZXL0400	20	3.18	3.85	4.64	5.56	6.60	7.77	9.06	10.48	12.03	1.94	2.08	2.22	2.38	2.54	2.70	2.88	3.06	3.25
	27	2.80	3.42	4.16	5.03	6.02	7.14	8.39	9.76	11.26	2.27	2.43	2.59	2.76	2.94	3.12	3.32	3.52	3.73
	32	2.58	3.17	3.87	4.71	5.67	6.76	7.97	9.31	10.77	2.58	2.75	2.93	3.11	3.30	3.50	3.71	3.92	4.15
	38	2.39	2.93	3.59	4.39	5.31	6.35	7.52	8.82	10.25	3.04	3.23	3.42	3.62	3.83	4.04	4.27	4.50	4.73
	43	2.27	2.78	3.41	4.17	5.06	6.07	7.21	8.47	9.86	3.50	3.69	3.90	4.11	4.33	4.56	4.80	5.04	5.30
	48	2.21	2.68	3.28	4.01	4.86	5.83				4.01	4.22	4.44	4.67	4.91	5.15			
ZXL0500	20	3.50	4.30	5.30	6.40	7.73	9.08	10.62	12.33	14.21	2.05	2.24	2.42	2.59	2.77	2.96	3.16	3.37	3.60
	27	3.12	3.84	4.73	5.79	7.01	8.39	9.92	11.60	13.42	2.56	2.72	2.87	3.03	3.20	3.38	3.57	3.79	4.02
	32	2.79	3.56	4.48	5.56	6.77	8.12	9.60	11.21	12.94	2.89	3.04	3.19	3.35	3.53	3.71	3.92	4.15	4.41
	38	2.65	3.43	4.35	5.38	6.53	7.79	9.15	10.61	12.17	3.30	3.46	3.62	3.79	3.99	4.20	4.43	4.70	4.99
	43	2.56	3.31	4.16	5.00	6.16	7.30	8.52	9.81	11.18	3.68	3.85	4.04	4.24	4.46	4.70	4.98	5.28	5.62
	48	2.30	2.97	3.73	4.56	5.57	6.60				4.12	4.32	4.54	4.78	5.04	5.33			
ZXL0600	20	3.70	4.70	5.84	7.14	8.63	10.32	12.23	14.38	16.78	2.56	2.72	2.89	3.09	3.32	3.57	3.85	4.16	4.50
	27	3.51	4.44	5.51	6.72	8.09	9.66	11.42	13.41	15.64	3.21	3.37	3.55	3.75	3.97	4.22	4.49	4.78	5.11
	32	3.44	4.35	5.37	6.53	7.85	9.34	11.02	12.91	15.03	3.58	3.76	3.96	4.17	4.40	4.66	4.94	5.24	5.56
	38	3.28	4.17	5.17	6.29	7.55	8.98	10.58	12.37	14.38	4.05	4.27	4.51	4.76	5.02	5.30	5.60	5.93	6.28
	43	2.96	3.86	4.85	5.96	7.19	8.57	10.12	11.85	13.78	4.58	4.85	5.13	5.42	5.72	6.04	6.38	6.73	7.11
	48	2.71	3.50	4.29	5.39	6.60	7.96				5.32	5.65	5.98	6.33	6.68	7.05			
ZXL0750	20	4.20	5.60	6.90	8.00	9.50	11.43	13.31	15.49	17.97	3.02	3.17	3.34	3.53	3.74	3.99	4.27	4.60	4.96
	27	4.00	5.16	6.18	7.43	8.91	10.80	12.58	14.78	17.24	3.51	3.68	3.87	4.08	4.33	4.61	4.93	5.29	5.70
	32	3.76	4.71	5.84	7.17	8.68	10.40	12.31	14.44	16.78	3.88	4.06	4.28	4.52	4.79	5.10	5.45	5.84	6.28
	38	3.52	4.55	5.71	7.02	8.48	10.09	11.86	13.80	15.90	4.40	4.61	4.85	5.12	5.43	5.77	6.16	6.59	7.08
	43	3.41	4.42	5.53	6.75	8.07	9.52	11.08	12.76	14.58	4.93	5.17	5.43	5.73	6.07	6.45	6.87	7.34	7.86
	48	3.12	4.04	5.01	6.06	7.50	8.70				5.58	5.85	6.14	6.47	6.84	7.25			

**Note:** Based on the return gas temperature of 5°C, Power include condenser fan.  
 Shaded ambient data are typical design conditions for unit selection.





Performance Tables



ZXL Unit Capacity And Power (kW) At 50Hz For Refrigerant R404a

Model	Ambient Temperature (°C)	Capacity									Power								
		Evaporating Temperature (°C)									Evaporating Temperature (°C)								
		-40	-35	-30	-25	-20	-15	-10	-5	0	-40	-35	-30	-25	-20	-15	-10	-5	0
ZXL020E	20	1.83	2.17	2.55	2.97	3.42	3.92	4.46	5.04	5.66	1.22	1.36	1.50	1.65	1.70	1.95	2.12	2.28	2.38
	27	1.66	2.02	2.42	2.86	3.34	3.86	4.42	5.02	5.66	1.35	1.47	1.60	1.73	1.86	2.00	2.14	2.29	2.44
	32	1.45	1.82	2.24	2.70	3.19	3.73	4.31	4.92	5.58	1.50	1.60	1.71	1.83	1.95	2.08	2.21	2.34	2.48
	38	1.25	1.49	1.93	2.40	2.92	3.47	4.07	4.70	5.38	1.72	1.81	1.91	2.01	2.12	2.23	2.34	2.46	2.59
	43	1.10	1.23	1.58	2.07	2.60	3.18	3.79	4.44	5.13	1.95	2.03	2.11	2.20	2.30	2.39	2.50	2.60	2.72
	48	0.99	1.12	1.16	1.67	2.21	2.80				2.22	2.29	2.36	2.44	2.52	2.60			
ZXL025E	20	2.00	2.36	2.86	3.44	4.10	4.83	5.64	6.53	7.49	1.34	1.46	1.55	1.66	1.76	2.10	2.33	2.44	2.54
	27	1.89	2.31	2.80	3.37	4.02	4.74	5.54	6.42	7.37	1.59	1.68	1.77	1.87	1.97	2.23	2.36	2.50	2.64
	32	1.80	2.26	2.74	3.30	3.94	4.65	5.44	6.31	7.25	1.84	1.90	1.99	2.08	2.18	2.35	2.48	2.61	2.74
	38	1.63	2.03	2.50	3.05	3.68	4.38	5.15	6.01	6.94	2.12	2.16	2.22	2.31	2.41	2.61	2.72	2.84	2.96
	43	1.31	1.70	2.16	2.70	3.31	4.01	4.77	5.62	6.54	2.44	2.45	2.50	2.57	2.67	2.90	3.01	3.11	3.22
	48	1.20	1.24	1.69	2.22	2.82	3.51				2.89	2.90	2.91	2.98	3.08	3.28			
ZXL030E	20	2.23	2.87	3.62	4.45	5.35	6.30	7.29	8.30	9.31	1.55	1.73	1.90	2.07	2.10	2.39	2.53	2.60	2.70
	27	2.09	2.58	3.17	3.85	4.60	5.41	6.25	7.61	8.67	1.67	1.84	2.00	2.15	2.30	2.45	2.58	2.71	2.83
	32	2.08	2.49	3.00	3.60	4.27	5.00	5.77	7.35	8.38	1.89	2.05	2.20	2.35	2.49	2.62	2.75	2.87	2.99
	38	2.00	2.33	2.77	3.31	3.92	4.59	5.31	6.95	7.95	2.31	2.45	2.60	2.73	2.86	2.99	3.10	3.21	3.32
	43	1.73	2.03	2.44	2.95	3.54	4.19	4.89	6.55	7.52	2.77	2.91	3.05	3.18	3.30	3.41	3.52	3.62	3.72
	48	1.50	1.70	2.00	2.38	2.96	3.61				3.36	3.49	3.61	3.73	3.84	3.95			
ZXL035E	20	2.70	3.47	4.25	5.07	5.95	6.92	8.00	9.22	10.62	1.91	1.95	2.03	2.30	2.50	2.70	2.80	3.00	3.20
	27	2.55	3.31	4.07	4.85	5.69	6.61	7.63	8.78	10.09	2.26	2.33	2.43	2.56	2.72	2.90	3.08	3.27	3.47
	32	2.47	3.20	3.94	4.68	5.48	6.35	7.31	8.40	9.63	2.59	2.67	2.79	2.93	3.11	3.31	3.52	3.74	3.96
	38	2.37	3.08	3.75	4.45	5.17	5.97	6.85	7.84	8.98	3.00	3.09	3.22	3.38	3.58	3.79	4.03	4.28	4.53
	43	2.28	2.94	3.57	4.20	4.86	5.59	6.38	7.29	8.33	3.31	3.40	3.58	3.70	3.91	4.14	4.39	4.66	4.94
	48	2.17	2.76	3.33	3.89	4.48	5.12				4.00	4.15	4.30	4.45	4.50	4.60			
ZXL040E	20	3.78	4.51	5.38	6.38	7.49	8.71	10.01	11.39	12.84	2.45	2.70	2.75	3.01	3.05	3.12	3.90	4.07	
	27	3.24	3.99	4.86	5.85	6.93	8.10	9.35	10.66	12.01	2.69	2.88	3.10	3.34	3.40	3.50	4.10	4.31	4.20
	32	3.02	3.77	4.63	5.58	6.63	7.75	8.93	10.16	11.43	2.99	3.17	3.39	3.64	3.90	4.17	4.43	4.67	4.50
	38	2.85	3.56	4.37	5.27	6.25	7.28	8.36	9.48	10.63	3.54	3.70	3.91	4.15	4.41	4.68	4.94	5.19	4.88
	43	2.67	3.34	4.10	4.93	5.83	6.77	7.75	8.76	9.78	4.08	4.22	4.40	4.62	4.87	5.12	5.38	5.63	5.41
	48	2.38	2.99	3.68	4.43	5.23	6.06				4.63	4.73	4.88	5.07	5.29	5.52			5.85
ZXL050E	20	4.42	5.18	6.21	7.47	8.91	10.50	12.20	13.98	15.78	2.70	3.00	3.20	3.40	3.65	3.80	4.20	4.50	
	27	3.80	4.58	5.58	6.78	8.12	9.57	11.09	12.64	14.19	2.92	3.16	3.39	3.62	3.86	4.09	4.40	4.58	4.70
	32	3.52	4.31	5.29	6.43	7.69	9.04	10.42	11.81	13.17	3.26	3.49	3.72	3.96	4.20	4.46	4.72	5.00	4.83
	38	3.25	4.03	4.98	6.06	7.22	8.43	9.65	10.84	11.97	3.88	4.10	4.33	4.57	4.83	5.11	5.41	5.73	5.29
	43	2.99	3.77	4.69	5.71	6.78	7.87	8.95	9.97	10.89	4.43	4.64	4.87	5.12	5.40	5.70	6.03	6.39	6.07
	48	2.63	3.40	4.28	5.23	6.21	7.19				4.89	5.10	5.33	5.59	5.88	6.21			6.77
ZXL060E	20	4.84	5.80	6.92	8.19	9.59	11.11	12.72	14.41	16.16	3.00	3.20	3.50	3.76	3.90	4.15	4.41	4.67	
	27	4.49	5.51	6.68	7.99	9.42	10.95	12.57	14.27	16.01	3.62	3.84	4.08	4.36	4.66	4.97	5.30	5.63	5.20
	32	4.30	5.32	6.48	7.77	9.17	10.67	12.26	13.91	15.60	4.04	4.27	4.53	4.83	5.16	5.51	5.88	6.27	5.97
	38	4.07	5.02	6.12	7.34	8.66	10.08	11.57	13.11	14.70	4.60	4.84	5.12	5.44	5.80	6.19	6.61	7.05	6.66
	43	3.81	4.67	5.67	6.79	8.00	9.30	10.67	12.09	13.54	5.17	5.41	5.69	6.03	6.42	6.84	7.30	7.78	7.51
	48	3.42	4.16	5.03	6.00	7.07	8.22				5.88	6.11	6.41	6.76	7.16	7.61			8.29
ZXL075E	20	5.50	6.64	7.94	9.41	11.06	12.91	14.96	17.24	19.75	3.47	3.73	4.01	4.31	4.64	4.98	5.34	5.70	
	27	4.99	6.14	7.42	8.84	10.40	12.13	14.03	16.12	18.41	3.93	4.20	4.51	4.84	5.21	5.59	6.01	6.44	6.09
	32	4.75	5.90	7.14	8.50	9.99	11.61	13.39	15.33	17.45	4.35	4.63	4.94	5.30	5.68	6.10	6.55	7.03	6.89
	38	4.49	5.61	6.80	8.08	9.46	10.94	12.55	14.30	16.19	4.98	5.25	5.58	5.95	6.36	6.81	7.30	7.83	7.53
	43	4.21	5.30	6.43	7.63	8.90	10.25	11.71	13.28	14.97	5.61	5.89	6.22	6.60	7.03	7.51	8.03	8.59	8.38
	48	3.81	4.85	5.91	7.01	8.16	9.38				6.38	6.65	6.98	7.38	7.82	8.32			9.19

Note: Based on the return gas temperature of 5°C, Power include condenser fan.  
Shaded ambient data are typical design conditions for unit selection.

## ZX LT Unit (Liquid Line Temperature)

Typical Liquid Line Temperature °C

R22

Evap Temp °C	Ambient °C					
	20	27	32	38	43	48
-40	-11	-3	7	7	11	14
-35	-8	-1	9	9	13	16
-30	-4	2	12	12	16	19
-25	0	5	14	14	19	23
-20	5	9	18	18	22	26
-15	10	13	21	21	25	30
-10	15	17	25	25	29	
-5	20	22	29	29	33	
0	26	26	33	33	37	

Typical Liquid Line Temperature °C

R404A

Evap Temp °C	Ambient °C					
	20	27	32	38	43	48
-40	-8	-1	3	8	13	19
-35	-4	2	6	11	15	21
-30	0	6	9	13	18	23
-25	5	10	13	17	21	26
-20	9	14	17	20	24	30
-15	13	18	21	24	28	34
-10	16	22	25	29	33	
-5	20	26	29	33	37	
0	23	29	33	38	42	

Typical Values With Individual Values Within +/-5°C

Note: ZXLT CDU is designed with vapor injection technology. The condenser liquid line temperature will be sub cooled by the vapor injection plate heat exchanger.

Wiring Diagram (ZX MT & LT Units)

ZX/ZXL Condensing Unit Wiring Diagram 380-3-50HZ

052-2284-00  
2008-03-11

ATTENTION: Unit MUST be grounded!

- NOTES:
1. Dashed line "- - -" denotes wiring by installer.
  2. Defrost module and wiring are optional extras.
  3. Neutral "N" and Earth "E" wirings are not shown in harnesses for clarity.
  4. Live wires U, V, W should never be connected to "N" on the power supply board.

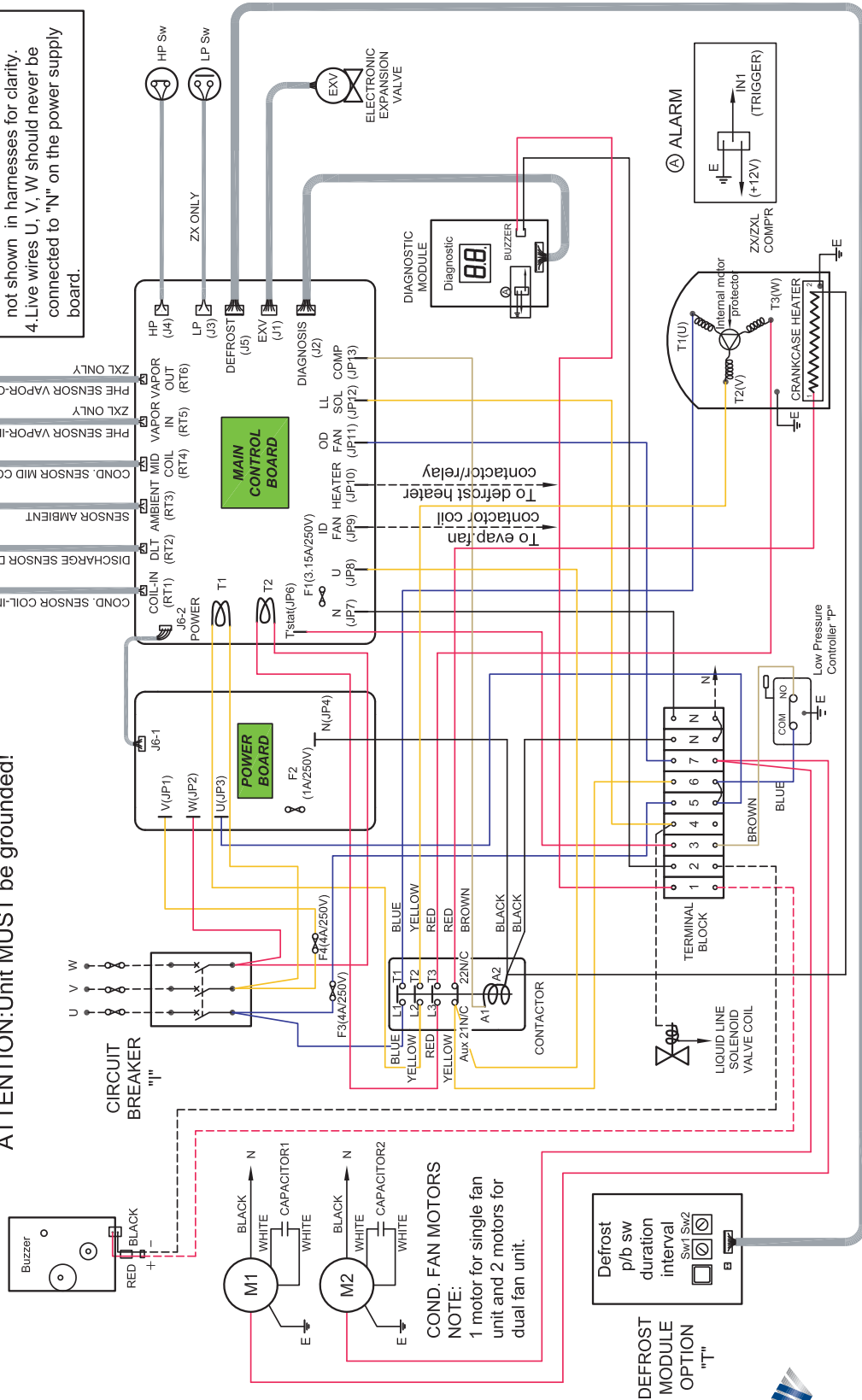

DEFROST MODULE OPTION "T"  
Defrost p/b sw duration interval  
Swt Sw2

COND. FAN MOTORS  
NOTE:  
1 motor for single fan unit and 2 motors for dual fan unit.

ALARM

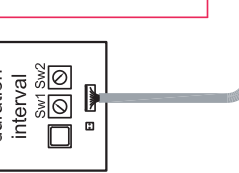
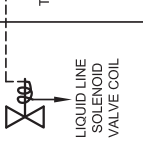
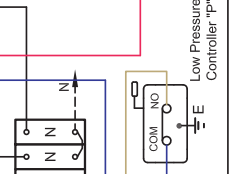
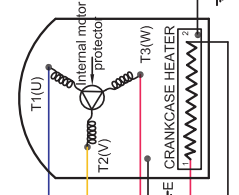
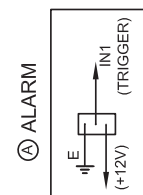

## Technical Data

### ZX MT Units

ZX Model	ZX0200 ZX020E	ZX0300 ZX030E	ZX0400 ZX040E	ZX0500 ZX050E	ZX0600 ZX060E	ZX0750 ZX075E	ZX0760 ZX076E
CDU Capacity @ GB/ARI MT Condition: ET/AT/RGT-6.7/32/18.3°C (R22/R404A)(KW)	3.85/4.30	5.50/6.00	7.30/7.80	9.30/10.70	11.20/11.80	12.60/13.20	12.85/13.46
CDU COP @ GB/ARI MT Condition: ET/AT/RGT-6.7/32/18.3°C (R22/R404A)	2.41/2.26	2.50/2.35	2.52/2.29	2.66/2.43	2.60/2.41	2.57/2.40	2.65/2.50
Compressor Model (R22/R404A)	ZX15KC-TFD ZX15KCE-TFD	ZX21KC-TFD ZX21KCE-TFD	ZX30KC-TFD ZX30KCE-TFD	ZX38KC-TFD ZX38KCE-TFD	ZX45KC-TFD ZX45KCE-TFD	ZX51KC-TFD ZX51KCE-TFD	ZX51KC-TFD ZX51KCE-TFD
Norminal Input Rating (HP)	2	3	4	5	6	7.5	7.5
Oil Type	MINERAL/ POE	MINERAL/ POE	MINERAL/ POE	MINERAL/ POE	MINERAL/ POE	MINERAL/ POE	MINERAL/ POE
Compressor Oil Re Charge Volume (Litres)	1.18	1.33	1.83	1.83	1.66	1.66	1.66
Oil Separator Charge Volume (Litres)	0.5	0.5	0.5	0.5	0.5	0.5	0.5
Compressor Rated Load Current (A) (R22/R404A)	4.3/5.0	5.7/6.1	7.4/7.5	8.9/9.6	11.5/11.5	12.0/11.8	12.0/11.8
Compressor Locked Rotor Current (A)	26	36	44.3	58.6	67	101	101
Number of Fans	1	1	1	2	2	2	2
Total Fan Motor (W)	116	116	116	246	246	246	246
Fan Diameter (mm)	450	450	450	450	450	450	450
Fan Speed (rpm)	830	830	830	830	830	830	830
Receiver Volume at 32C (kg)(R22/R404A)	5.1/4.4	5.1/4.4	5.1/4.4	7.2/6.3	7.2/6.3	7.2/6.3	7.2/6.3
Suction Pipe Outer Diameter (Inch)	3/4	3/4	7/8	7/8	7/8	7/8	7/8
Liquid Pipe Outer Diameter (Inch)	1/2	1/2	1/2	1/2	1/2	1/2	1/2
ZX Sound level @ 1m (dBA)	60	60	60	60	60	60	60
Net Weight(kg)	76	79	91	108	112	118	121
Dimension of CDU (mm)	1029X424 X840	1029X424 X840	1029X424 X840	1029X424 X1242	1029X424 X1242	1029X424 X1242	1029X424 X1242
Air Flow (m <sup>3</sup> /h)	2922	2922	2922	5910	5910	5910	5910



## Technical Data

### ZX LT Units

ZXL Model	ZXL0200 ZXL020E	ZXL0250 ZXL025E	ZXL0300 ZXL030E	ZXL0350 ZXL035E	ZXL0400 ZXL040E	ZXL0500 ZXL050E	ZXL0600 ZXL060E	ZXL0750 ZXL075E
CDU Capacity @ ARI LT Condition: ET/AT/RGT-32/32/5°C(R22/R404A)(KW)	1.7/2.11	1.91/2.51	2.34/2.80	2.78/3.65	3.57/4.26	4.05/4.99	4.96/5.91	5.39/6.65
CDU COP @ ARI LT Condition: ET/AT/RGT-32/32/5°C (R22/R404A)	1.20/1.24	1.17/1.28	1.28/1.29	1.26/1.34	1.24/1.29	1.29/1.36	1.27/1.33	1.28/1.38
CDU Capacity @ GB LT Condition: ET/AT/RGT-23/32/5°C(R22/R404A)(KW)	2.37/2.86	2.87/3.54	3.21/3.84	4.04/5.00	5.04/6.03	6.02/6.92	6.90/8.44	7.78/9.05
CDU COP @ GB LT Condition: ET/AT/RGT-23/32/5°C (R22/R404A)	1.51/1.51	1.63/1.67	1.59/1.59	1.68/1.67	1.57/1.60	1.76/1.71	1.62/1.68	1.68/1.66
Compressor Model (R22/R404A)	ZXI06KC-TFD ZXI06KCE-TFD	ZXI08KC-TFD ZXI08KCE-TFD	ZXI09KC-TFD ZXI09KCE-TFD	ZXI11KC-TFD ZXI11KCE-TFD	ZXI14KC-TFD ZXI14KCE-TFD	ZXI15KC-TFD ZXI15KCE-TFD	ZXI18KC-TFD ZXI18KCE-TFD	ZXI21KC-TFD ZXI21KCE-TFD
Normal Input Rating (HP)	2	2.5	3	3.5	4	5	6	7.5
Oil Type	MINERAL/ POE	MINERAL/ POE	MINERAL/ POE	MINERAL/ POE	MINERAL/ POE	MINERAL/ POE	MINERAL/ POE	MINERAL/ POE
Compressor Oil Re Charge Volume(Litres)	0.56	0.56	0.56	1.24	1.24	1.24	1.77	1.77
Oil Separator Charge Volume (Litres)	0.5	0.5	0.5	0.5	0.5	0.5	0.5	0.5
Compressor Rated Load Current(A)(R22/R404A)	5.4/5.6	5.5/6.2	5.7/6.0	7.4/8.3	8.1/8.6	8.8/10	11.1/11.1	12.1/14.6
Compressor Locked Rotor Current (A)	39.2	39.2	39.2	51.5	51.5	51.5	74	101
Number of Fans	1	1	1	1	1	2	2	2
Total Fan Motor (W)	116	116	116	116	116	246	246	246
Fan Diameter (mm)	450	450	450	450	450	450	450	450
Fan Speed (rpm)	830	830	830	830	830	830	830	830
Receiver Volume at 32C (kg)(R22/R404A)	5.1/4.4	5.1/4.4	5.1/4.4	5.1/4.4	5.1/4.4	7.2/6.3	7.2/6.3	7.2/6.3
Suction Pipe Outer Diameter (Inch)	3/4	3/4	3/4	7/8	7/8	7/8	7/8	7/8
Liquid Pipe Outer Diameter (Inch)	1/2	1/2	1/2	1/2	1/2	1/2	1/2	1/2
ZXL Sound level @ 1m (dBA)	60	60	60	61	61	61	61	61
Net Weight(kg)	79	81	81	93	93	106	116	121
Dimension of CDU(mm)	1029X424 X840	1029X424 X840	1029X424 X840	1029X424 X840	1029X424 X840	1029X424 X1242	1029X424 X1242	1029X424 X1242
Air Flow (m <sup>3</sup> /h)	2922	2922	2922	2922	2922	5910	5910	5910



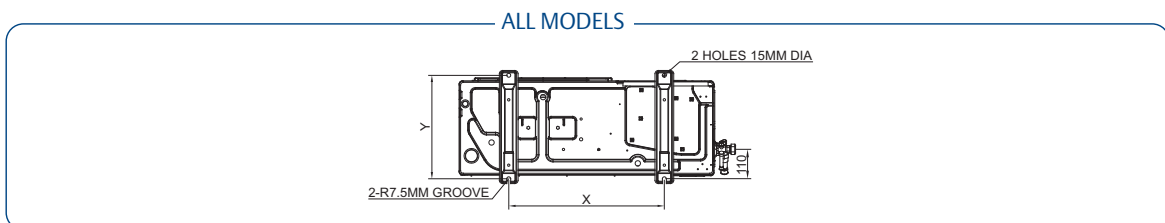
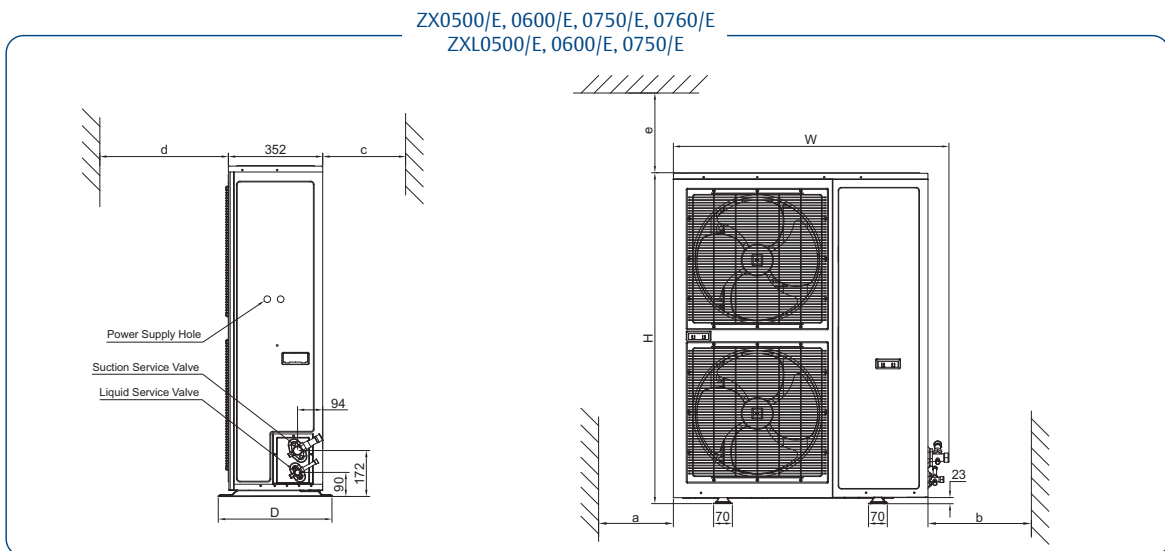
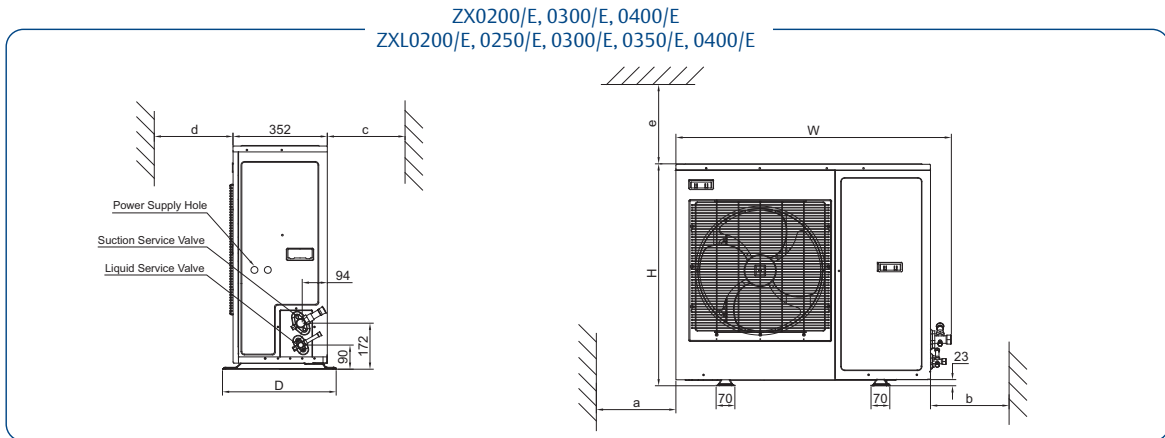















## Dimensional Drawing (ZX MT & LT Units)



MODEL	WIDTH		HEIGHT	DEPTH	MTG	CENTRES	CONN. SIZE		INSTALLATION CLEARANCES				
	W	H	D	X	Y	Suction*	Liquid*	a	b	c	d	e	
	mm	mm	mm	mm	mm	mm	M.Fl.	M.Fl.	mm	mm	mm	mm	mm
ZX0200/E, 0300/E, 0400/E ZXL0200/E, 0250/E, 0300/E, 0350/E, 0400/E	1029	840	424	580	388		3/4"Ⓞ	1/2"	300	500	300	500	500
ZX0500/E, 0600/E, 0750/E, 0760/E ZXL0500/E, 0600/E, 0750/E	1029	1242	424	580	388		7/8"	1/2"	300	500	300	500	500

NOTEⓄ: ZX MT 2HP & 3HP: 3/4"; ZX MT 4HP: 7/8"  
ZX LT 2HP, 2.5HP & 3HP: 3/4"; ZX LT 3.5HP & 4HP: 7/8"

## Diagnostic Messaging – LED Definitions (ZX MT and LT Units)

LED1-Unit Status		LED2-Error/Warning Code	
Display	Status	Display	Error/Warning
	Idle (Stop When Reach To Set-point)		No error/warnings
	Run		Compressor Phase Error (Wrong Phase Sequence/Loss Of Phase)
	About To Start <sup>1</sup>		Compressor Inside Thermal Protector Trip
	Defrost		Compressor Over Current
	Stop Due To Error		Discharge Gas Overheat
	Lockout		Compressor High Pressure Cut Out
			Compressor Low Pressure Cut Out <sup>2</sup>
			DLT Thermistors Failure
			Ambient Temperature Sensor Failure
			Mid-coil Temperature Sensor Failure
			PHE Vapor In Temperature Sensor Failure or over range <sup>3</sup>
			PHE Vapor Out Temperature Sensor Failure or over range <sup>3</sup>
			System Liquid Flood Back Warning

Note:

- <sup>1</sup> This signal is for Fresh Start, Normal Start Program and any start request delay.
- <sup>2</sup> “LP Cutout” signal is not applicable in ZXL condensing unit.
- <sup>3</sup> PHE Vapor In/Out Temperature Sensor is not applicable in ZX medium temperature condensing unit.

## Diagnostic Initialization Message (ZX MT and LT Units)

When the unit is initially powered on, the diagnostic module will show the following signal.

8 8 (1 second)-> 0 2 (3 seconds)-> - F (3 second)-> 0 0

0 2 - Software Version No.

- F - Unit Identification Code

→ "F"-With OD Fan Speed Control; "-" - W/O OD Fan Speed Control  
→ "L"- ZXL; "-" - ZX

0 0 - Power On

## E2 control board dip switch setting

The E2 control board has 2 dip switches (2-bit and 3-bit) and 1 rotary switch. The rotary switch and the 2-bit dip switch are used in combination to select the compressor used on the unit. The selected compressor relates to the over-current-limit for the specified unit.

The 3-bit dip switch is used if the customer chooses to use the E2 control for evaporator fan control.

Fig 12 shows the dip switches and rotary switch in the E2 control board.

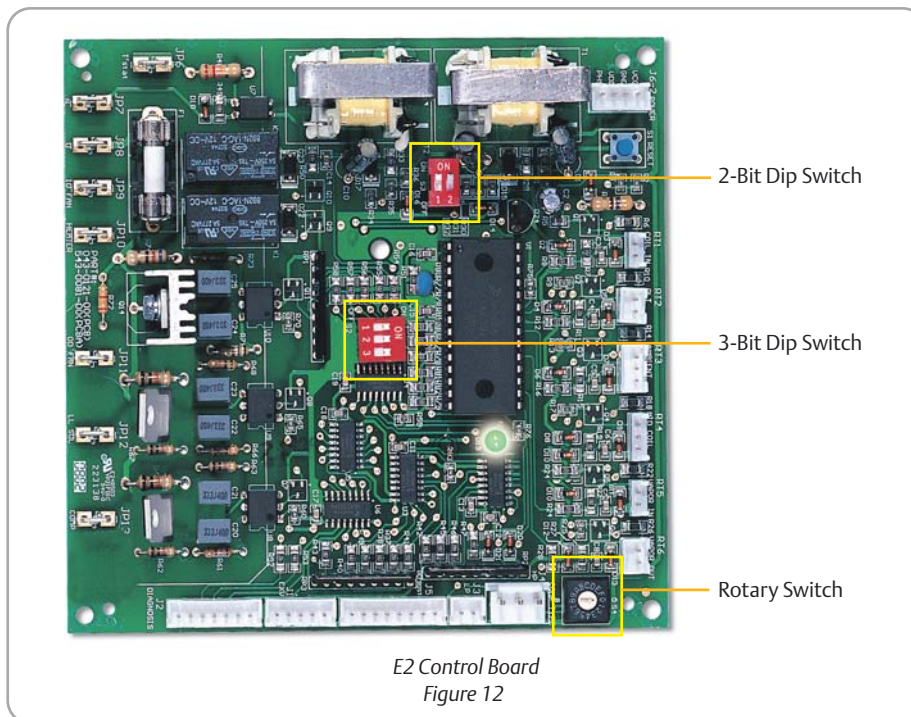



### ZX MT Units (Dip Switch And Rotary Switch Settings)

Model Name**	Rotary Switch	2bit Dip-Switch	3bit Dip-Switch
Spare Board	0	ON/ON	OFF/OFF/OFF
ZX15KC/E-TFD	1	ON/ON	Evaporator Fan On/Off Logic Same As Compressor (this is the factory default setting)
ZX21KC/E-TFD	2	ON/ON	
ZX30KC/E-TFD	3	ON/ON	
ZX38KC/E-TFD	4	ON/ON	ON/ON/ON
ZX45KC/E-TFD	5	ON/ON	Evaporator fan will be ON all the time Irrespective of compressor is ON or OFF)
ZX51KC/E-TFD	6	ON/ON	

The settings are pre-set at factory in new units

### ZX LT Units (Dip Switch And Rotary Switch Settings)

Model Name**	Rotary Switch	2bit Dip-Switch	3bit Dip-Switch
Spare Board	0	ON/ON	OFF/OFF/OFF
ZXI06KC/E-TFD	1	ON/ON	Evaporator Fan On/Off Logic Same As Compressor (this is the factory default setting)
ZXI08KC/E-TFD	2	ON/ON	
ZXI09KC/E-TFD	3	ON/ON	
ZXI11KC/E-TFD	4	ON/ON	ON/ON/ON
ZXI14KC/E-TFD	5	ON/ON	Evaporator fan will be ON all the time Irrespective of compressor is ON or OFF)
ZXI15KC/E-TFD	6	ON/ON	
ZXI18KC/E-TFD	7	ON/ON	
ZXI21KC/E-TFD	8	ON/ON	

The settings are pre-set at factory in new units

## E2 controller trip set-points & actions (ZX MT & LT units)

Fault Type	Trip Set Point	E2 Control Actions	Auto Resets	Possible Error And Solution
Reverse Phase / Loss Of Phase (3 Phase Only)	Incorrect voltage Sequence	-Lockout unit -Display Incorrect Phase Sequence on diagnostic -Initiate Buzzer/ Dialer Relay	Unit will not start unless it is wired correctly	-Change voltage sequence at circuit break. -Check voltage sequence of the compressor;
Fresh Start	If power is reset, ambient < 35 °C or compressor off > 1 hour & signal for compressor start	-Compressor runs 3 sec and stops 20 sec -After 3 cycles, compressor runs continuously. -Display fresh start on diagnostic	Auto start	-Nothing is wrong, just wait till compressor runs continuously.
High Pressure Trip	Contact Open At 3.0 ±0.15Mpa Contact Close At 2.4±0.15Mpa	-Stop the unit -Display HP trip on diagnostic -Display waiting to restart on diagnostic -Auto start the unit after 3 minutes -Lockout unit if 6 trips in less than 1 hour -Display HP lockout on diagnostic -Initiate Buzzer/ Dialer Relay	5 Auto starts in 1 Hour	-Check whether HP cutout is functioning or is connected to control board; -Check whether condenser fan can run; -Check liquid line solenoid valve, liquid service valve are open;
Low Pressure Trip (Only in Med Temp Unit)	Contact Open At 0.1±0.05Mpa Contact Close At 0.2 ±0.05Mpa	-Stop the unit -Display LP trip on diagnostic -Display waiting to restart on diagnostic -Auto start the unit after 3 minutes	Auto Start	-Check whether evaporator need de-frost; -Check return gas service valve, is open; -Check LP cutout is functioning or is connected to control board
Discharge Gas Overheat	Discharge Temperature Over 132 °C	-Stop the unit -Display DLT trip on diagnostic -Display waiting to restart on diagnostic -Auto start the unit after 3 minutes -Lockout unit if 6 trips in less than 1 hour -Display DLT overheat lockout on diagnostic -Initiate Buzzer/ Dialer Relay	5 Auto starts in 1 Hour	-Check liquid line sight glass is full; -Check whether EXV is functioning and connected to control board
Over Current	Set Based On Compressor	-Stop the unit -Display over current trip on diagnostic -Display waiting to restart on diagnostic -Auto start the unit after 3 minutes -Lockout unit if 6 trips in less than 1 hour -Display over current lockout on diagnostic -Initiate Buzzer/ Dialer Relay	5 Auto starts in 1 Hour	Check rotary switch, make sure it is on the right position according to unit model; -Check oil level through compressor sight glass (Low temp unit only);
Electrical Failure	Compressor not drawing current after compressor contactor orangized	-Display compressor protector trip on diagnostic -Initiate Buzzer/ Dialer Relay -Auto start when protector reset, turn off buzzer/Dialer	Auto start	-Check whether contactor is pull-in? If not, check wiring of contactor coil; -Check wiring, make sure compressor is connected to contactor, and is powered; -Compressor motor thermal protector trips, wait till it reset.
Compressor Rapid Cycling	Minimum 3 minutes OFF time between starts	-Delay comp start, if minimum off time is less than 3 min -Display about to turn on diagnostic	Auto start	-Compressor start signal is active when unit just stops; the only thing need to do is to wait till unit start.

Fault Type	Trip Set Point	E2 Control Actions	Auto Resets	Possible Error And Solution
Discharge Line And Coil In Temperature Sensors Failure	(A) Actual DLT>160°C	<b>(Only Low Temp Unit)</b> -Stop the unit -Display DLT sensor failure on the diagnostic -Display waiting to restart on diagnostic -Auto start the unit after 3 minutes -Lockout unit if 6 trips in less than 1 hour -Display DLT sensor failure lockout on diagnostic -Initiate Buzzer/ Dialer Relay	5 Auto start in 1 Hour	-Check liquid sight glass is full. If not, system must have leakage at somewhere; -Check whether DLT sensor is connected to control board; -Check whether DLT sensor is OK. If not, replace it with a good one;
	(B) DLT Sensor fails and Actual DLT> 80°C			
	(C) Both coil-in and DLT sensor fail (short circuit)	<b>(Only Med Temp Unit)</b> -Display DLT sensor failure on diagnostic -Continue to run the unit on default mode	Run	-Check whether Coil In sensor is OK. If not, replace it with a good one
(D) Coil in sensor fails(short) and actual DLT<73°C				
Ambient Temperature Sensor Failure	Ambient sensor reads <-30°C or >63°C	-Display ambient temp sensors failure on diagnostic -Continue to run the unit on default mode	Run	-Check whether the sensors are connected to control board; -Display DLT sensor failure on diagnostic -Continue to run the unit on default mode
Condenser Mid-Coil Sensor Failure	Mid coil sensor reads <-30°C or >63°C	-Display mid coil temp sensors failure on diagnostic -Continue to run the unit on default mode	Run	-Check whether the sensors are connected to control board; -Check whether Coil-in is OK. If not, replace it with a new one; -Check whether compressor is having excessive flood back.
PHE Vapor In Sensor Failure (Only Low Temp Unit)	Vapor In sensor reads <-16°C or >73°C	-Display sensor error on diagnostics -Continue to run the unit on default mode	Run	-Check whether actual temperature is out of range; -Check whether the sensor is connected to control board; -Check whether the sensor is mounted at the right position;
PHE Vapor Out Sensor Failure (Only Low Temp Unit)	Vapor out sensor reads <-16°C or >73°C	-Display sensor error on diagnostics -Continue to run the unit on default mode	Run	-Check whether the sensor is in heat isolation material; -Check whether the sensor is failed.

## Vapor injection: specific application tips

### ZX LT CDU

ZX LT CDU applies vapor injection technology. As explained in the previous section, vapor injection improves LT operational efficiency and provides a reliable LT envelope. Vapor injection sub cools the main liquid line using the economizer cycle. The sub cooling of liquid line calls for some specific application tips which are applicable only for ZX LT CDU. They are

1. Liquid line pipe connecting the CDU service valve to the evaporator expansion valve has to be well insulated separately. The recommended insulation thickness is 12.5 mm (1/2 inches)
2. The lower liquid in temperature can increase the evaporator expansion valve capacities. Please follow valve manufactures recommended liquid temperature correction factors for proper selection of evaporator expansion valve.

**Contact us at:**

**Emerson Climate Technologies,  
Asia Pacific Headquarters**

10/F, Pioneer Building,,  
213 Wai Yip Street,  
Kwun Tong, Kowloon, Hong Kong.  
Tel: (852) 2866 3108  
Fax: (852) 2520 6227

**Australia**

**Emerson Climate Technologies Australia Pty Ltd**

Unit R7, 391 Park Road  
Regents Park, NSW 2143, Australia  
Tel: (61-2) 9795 2800  
Fax: (61-2) 9738 1699

**China - Shanghai**

**c/o Emerson Climate Technologies (Suzhou) Co. Ltd  
Shanghai Sales Office**

16/F., Jiu Shi Tower,  
28 Zhong Shan Road (South),  
Shanghai, P.R.China 200010  
Tel. (86-21) 6333 0808  
Fax (86-21) 6333 0516

**China - Beijing**

**c/o Emerson Climate Technologies (Suzhou) Co. Ltd  
Beijing Sales Office**

Room 310, Canway Building  
66 Nan Lishi Road, Xicheng District  
Beijing 100045, China  
Tel: (86-10) 6805 7825  
Fax: (86-10) 6805 6301

**China - Guangzhou**

**c/o Emerson Climate Technologies (Suzhou) Co. Ltd  
Guangzhou Sales Office**

Room 508-509, R&F Yinglong Plaza  
No. 76 Huangpu Road West,  
Guangzhou 510623, PRC.  
Tel: (86-20) 2886 7668  
Fax: (86-20) 2886 7622

**China - Suzhou**

**c/o Emerson Climate Technologies (Suzhou) Co. Ltd  
Suzhou Plant**

No. 69 Suhong West Road ,  
Suzhou Industrial Park , Suzhou ,  
Jiangsu Province , P.R.C. 215021 China.  
Tel: (86-512) 6257 5505  
Fax: (86-512) 6257 5506

**India - PUNE**

**Emerson Climate Technologies (India) Ltd**

1202/1, Ghole Road, Shivajinagar  
Pune 411 004, Maharashtra, India  
Tel: (91-20) 2553 4988  
Fax: (91-20) 2553 6350

**India - Mumbai**

**Emerson Climate Technologies (India) Ltd**

Unit No. 4,5,6 & 7, Bhaveshwar Arcade  
LBS Marg, Opp. Shreyas Cinema  
Ghatkopar (West)  
Mumbai 400 086, Maharashtra, India  
Tel: (91-22) 2500 6630/ 2500 6632  
Fax: (91-22) 2500 6570

**Indonesia**

**PT. Emerson Indonesia**

Wisma Kota BNI 46 16th floor Suite 16.01  
Jl. Jend.Sudirman Kav.1.Jakarta 10220  
Tel: (62)21-2513003 ext.6000  
Fax: (62)21-2510622

**Japan**

**c/o Emerson Japan Ltd**

Shin-yokohama Tosho Building No. 3  
3-9-5 Shin-Yokohama, Kohoku-ku  
Yokohama 222-0033 Japan  
Tel: (81-45)475 6371  
Fax: (81-45)475 3565

**Korea**

**c/o Emerson Electric (Korea) Ltd**

12F, Narae B/D, 719-1, Yeoksam-dong  
Gangnam-gu, Seoul, Korea 135-080  
Tel: (82-2) 3483-1500  
Fax: (82-2) 592-7883 / 592-7886

**Malaysia**

**c/o Emerson Electric (Malaysia) Sdn. Bhd.**

Level M2, Blk A, Menara PKNS-PJ  
Jalan Yong Shook Lin  
46050 Petaling Jaya, Selangor, Malaysia  
Tel: (60-3) 7949 9222  
Fax: (60-3) 7949 9333

**Philippines**

**Emerson Climate Technologies  
Global Service Centre - Manila**

4th floor, San Miguel Properties Center (SMPC),  
No. 7, St. Francis Avenue., Mandaluyong City  
Philippines  
Trunkline: (63-2) 4795-100/4795-200/4795-300  
Tel: (63-2) 702 1579 – Arnel Alegre  
Fax: (63-2) 479 5271

**Taiwan**

**c/o Emerson Electric (Taiwan) Co. Ltd**

5th Floor, No.2 Jen Ai Road  
Section 4, Taipei 10650, Taiwan  
Tel: (886-2) 2325 9555  
Fax: (886-2) 2702 9630/ 2784 0022

**Thailand - Rayong Plant**

**c/o Emerson Electric (Thailand) Ltd**

No. 24 Moo 4 Tambol Pluakdaeng, Amphur  
Pluakdaeng, Rayong 21140, Thailand  
Tel: (66-38) 957 000  
Fax: (66-38) 954 251

**Thailand - Bangkok**

**c/o Emerson Electric (Thailand) Ltd**

34th Floor Nation Tower  
1858/133 Bangna Trad  
Bangkok 10260 , Thailand  
Tel: (66-2) 716-4700  
Fax: (66-2) 751-4240

[aprefrigeration@emersonclimate.com](mailto:aprefrigeration@emersonclimate.com)