

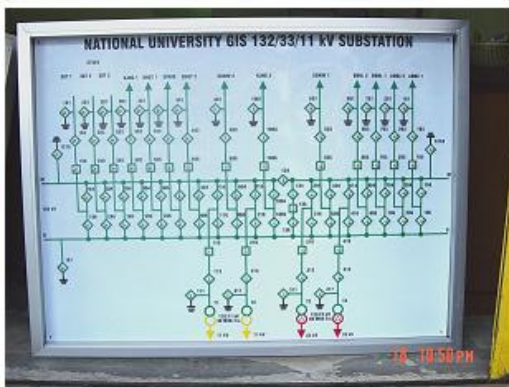

# SIGNAGE & SAFETY ACCESSORIES



Tab 18



# SUBSTATION MIMIC KEYBOARD

# SUBSTATION MIMIC KEYBOARD

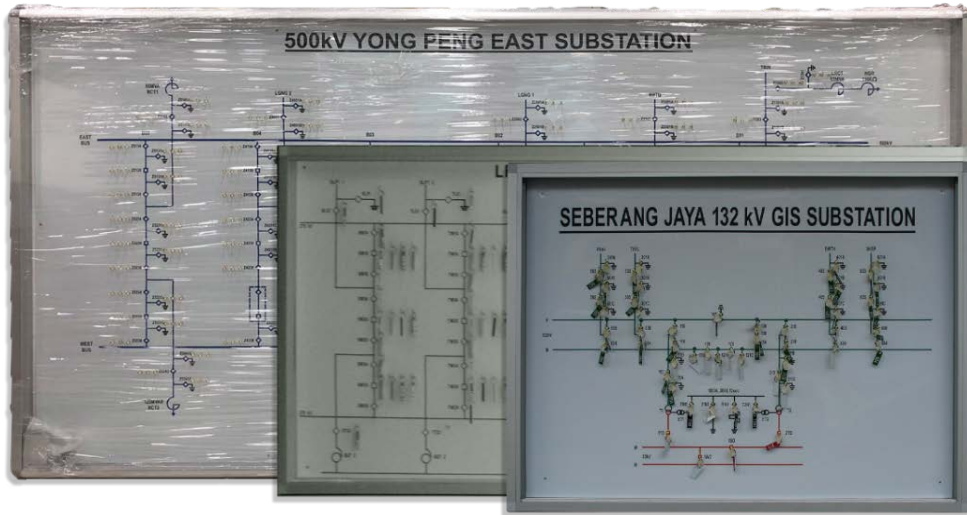

Item Code	Size
DSSB-SSA-SMK343	3' x 4' x 3"
DSSB-SSA-SMK363	3' x 6' x 3"



Power Plant



500kV



275kV (AIS)

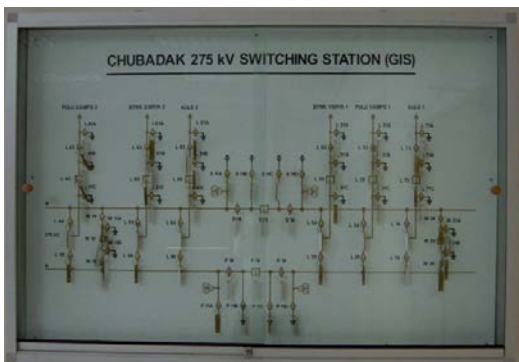

275kV (GIS)

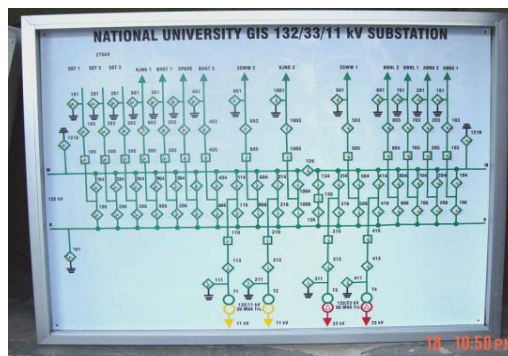

132/33/11kV (GIS)

SUBSTATION MIMIC KEYBOARD

## SUBSTATION MIMIC KEYBOARD

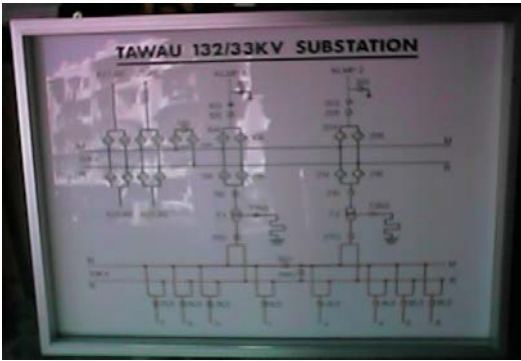

132/33kV (AIS)

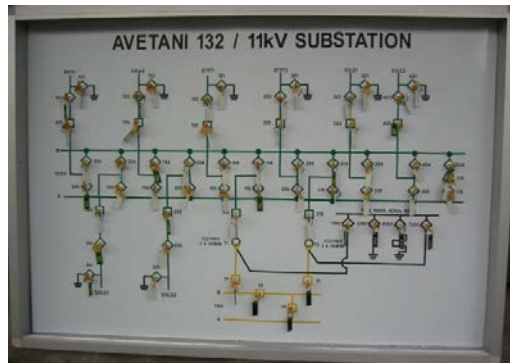

132/11kV (AIS)

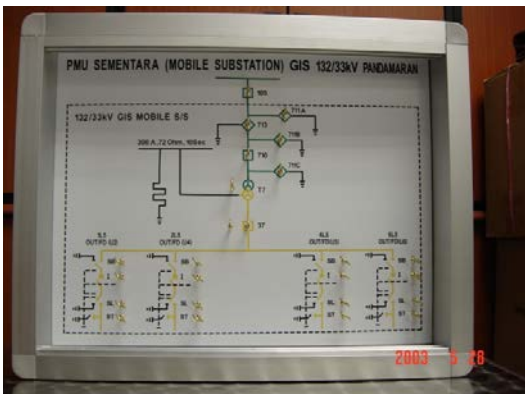

Mobile Substation

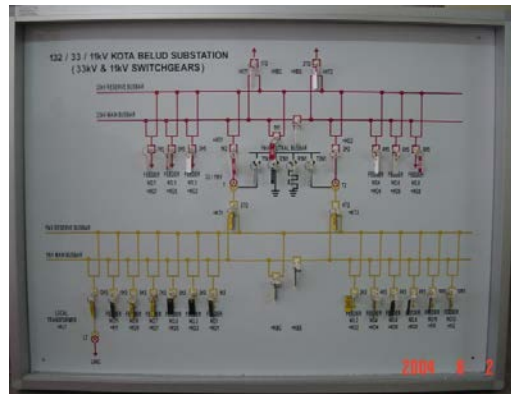

33kV & 11kV



33kV



11kV



Fitting Accessories for 3' x 6'  
Mimic Board



Fitting Accessories for 3' x 4'  
Mimic Board

SUBSTATION MIMIC KEYBOARD

## TOOL CABINETS

Item Code	Size
DSSB-SSA-TC348	3' x 4' x 8"



33kV S/S (AIS)



33kV S/S (GIS)



FITTING ACCESSORIES FOR TOOLS BOX

TOOL CABINETS



# SIGNAGES/ LABEL/ NAME PLATE

**SIGNAGES / LABEL / NAME PLATE  
(PVC / ALUMINIUM / STAINLESS STEEL)**



**Photo A**  
(400mm x 600mm (aluminium))



**Photo B**  
(210mm x 297mm (aluminium & Steel))



**Photo C**  
(900mm x 1200mm (alucarbon))



**Photo D**  
(210mm x 297mm (aluminium))



**Photo E**  
(500mm(L) x 400mm(H))



**Photo F**  
(297mm x 420mm(Alucarbon))

**SIGNAGES / LABEL / NAME PLATE**

**SIGNAGES / LABEL / NAME PLATE  
(PVC / ALUMINIUM / STAINLESS STEEL)**



**Photo G**  
(100mm diameter (Acrylic))



**Photo H**  
(1200mm x 180mm (Alucarbon))



**Photo I**  
(75mm x 200mm (Aluminium))



**Photo J**  
(125mm x 200mm (Acrylic))



**Photo K**  
(20mm x 60mm (Aluminium))

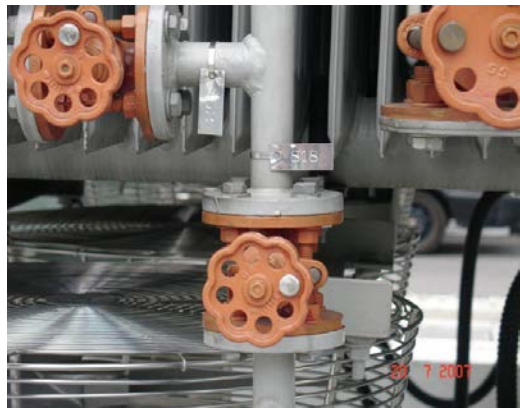

**Photo L**  
(20mm x 75mm (Stainless Steel))

**SIGNAGES / LABEL / NAME PLATE**



**SIGNAGES / LABEL / NAME PLATE  
(PVC / ALUMINIUM / STAINLESS STEEL)**



**Photo M**  
**(Signboard 550mm x 900mm(Alucarbon))**



**Photo N**  
**(75mm x 200mm (Stainless Steel))**



**Photo O**  
**(150mm x 150mm (Stainless Steel))**



**Photo P**  
**(300mm x 420mm (Aluminium) )**



**Photo Q**  
**(210mm x 297mm (Aluminium) )**



**Photo R**  
**(900mm x 1200mm (Alucarbon) )**

**SIGNAGES / LABEL / NAME PLATE**

**SIGNAGES / LABEL / NAME PLATE  
(PVC / ALUMINIUM / STAINLESS STEEL)**



**Photo S**  
(210mm x 297mm (Aluminium))



**Photo T**  
(Stainless Steel)



**Photo U**  
(210mm x 297mm (Alucarbon))



**Photo V**  
(600mm x 900mm (Alucarbon))



**Photo W**  
(75mm x 100mm (Acrylic))



**Photo X**  
(125mm x 200mm (Acrylic))

**SIGNAGES / LABEL / NAME PLATE**

**SIGNAGES / LABEL / NAME PLATE  
(PVC / ALUMINIUM / STAINLESS STEEL)**



**Photo Y  
(Sticker)**



**Photo Z  
(150mm x 300mm(Sticker) )**



**Photo AA  
(150mm x 300mm (Sticker) )**



**Photo AB  
(Sticker)**

SIEMENS		02/054473	AMT 300	CT	209 159
C73263 - A92 - B206		$I_{th} (40-3s) \text{ kA}$	(300/480/1050/850)kV		
EC 60044-1 / BS 3938		$I_{dyn} (100) \text{ kA}$	E	50 Hz	ext. 120%
CORE 1	CORE 2	CORE 3	CORE 4		
A $\frac{1200}{1}$	A $\frac{1200-600}{1}$	A $\frac{4000}{1}$	A $\frac{4000}{1}$	A _____	A _____
		CL X	CL X		
VA 30	VA 30 - 15	$I_0 < 10\text{mA at } V_k/2$			
CL 5P 20	CL 0.5 FS10	$V_k \geq 600 \text{ V}$	$V_k \geq 600 \text{ V}$		
		$R_{ct} < 6\Omega$	$R_{ct} < 6\Omega$		
secondary terminals					
1S1 - 1S2	2S1-2S3 2S2	3S1 - 3S2	4S1 - 4S2		

**Photo AC**

**SIGNAGES / LABEL / NAME PLATE**

**SIGNAGES / LABEL / NAME PLATE  
(PVC / ALUMINIUM / STAINLESS STEEL)**

**+ RA.27 = WXD6  
BUS COUPLER NO.6**

Photo AD

**RAWANG NO.2  
132kV O/H FEEDER  
CONTROL**

Photo AE

**=WBE-J  
BUS COUPLER**

Photo AF

**=T1.A1-J  
30MVA 132/11kV  
TRANSFORMER NO.1**

Photo AG

**=WLE 3-J  
SRI GADING LINE NO.1**

Photo AH

**EO 9+V  
KL NORTH  
132kV O/H FEEDER**

Photo AI

**CAUTION:  
PLEASE ENSURE THAT CT  
SECONDARY WINDINGS ARE  
LINKED BEFORE THE TEST  
PLUG IS INSERTED INTO  
THE TEST BLOCK**

Photo AK

**NEUTRAL EARTHING RESISTOR**  
 MAKE : MAHKOTA TECH. SDN BHD  
 RATED VOLTAGE :  $33/\sqrt{3}$  (INS. CLASS 25kV)  
 RATED CURRENT : 1600A  
 RATED DUTY : 10 SEC  
 RATED RESISTANCE : 12 OHMS  
 APPROX. WEIGHT : 2100kg  
 MANUFACTURED : 1997

Photo AJ

**132 / 11KV  
REMOTE TAP CHANGE  
CONTROL PANEL TX.1**

Photo AJ

**R.T.C.C.PANEL  
90MVA 132/33KV  
TRANSFORMER NO.1**

Photo AK

**OIL TEMP  
INDICATOR**

Photo AL

**AMMETER  
300 / 600 / 1A**

Photo AM

**4W10**

Photo AN

**SIGNAGES / LABEL / NAME PLATE**

**SIGNAGES / LABEL / NAME PLATE  
(PVC / ALUMINIUM / STAINLESS STEEL)**

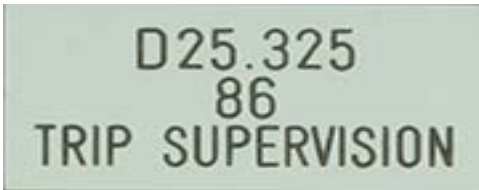

Photo AO

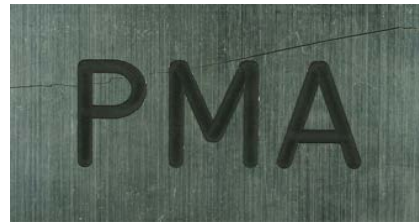

Photo AP

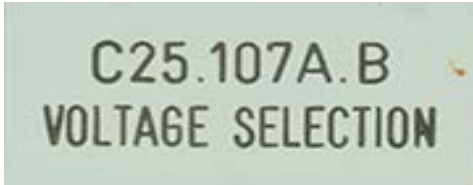

Photo AQ



Photo AR



Photo AS



Photo AT

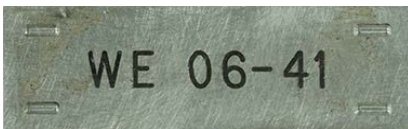

Photo AU



Photo AV



Photo AW

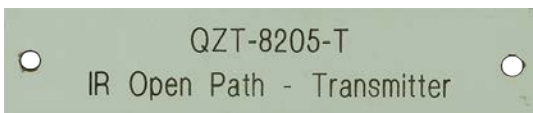

Photo AY



Photo AX



Photo BA

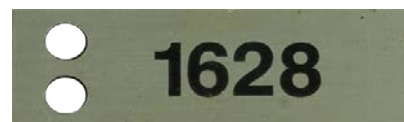

Photo AZ



Photo BB



Photo BC

**SIGNAGES / LABEL / NAME PLATE**

**SIGNAGES / LABEL / NAME PLATE  
(PVC / ALUMINIUM / STAINLESS STEEL)**

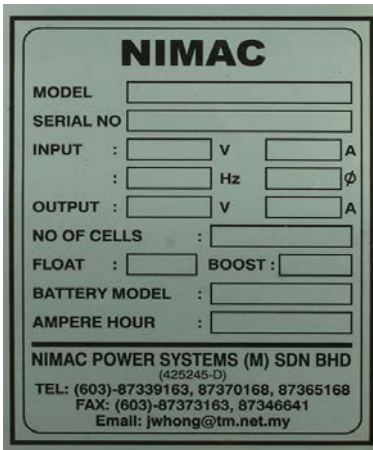

Photo BD



Photo BG



Photo BI



Photo BK

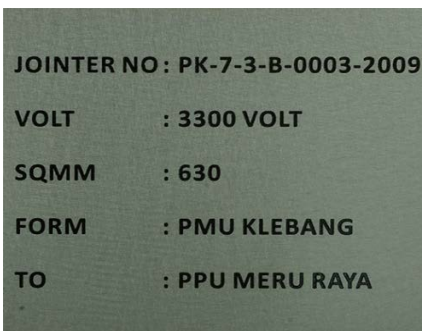

Photo BM

ABB Manufacturing Sdn. Bhd. Malaysia		OVERALL SERIAL NO : 992714530079	
Circuit-breaker type	LTB145D1/B	Operating device type	BLK222
No.	8421940	No.	8421973
Order	LT 8018	Order	LT 8018
Voltage	145 kV	Breaking current	31.5 kA
Insulation level	650/275 kV	DC-component	51 %
Frequency	50 Hz	First-pole-to-clear factor	1,5
Normal current	3150 A	Making current	79 kA
Gas pressure SF <sub>6</sub>	abs	Short-time current	3 s 31.5 kA
Max. working pressure	0,90 MPa	Mass total	1060 kg
Filling 20°C	0,50 MPa	Mass of gas	5 kg
Signal 20°C	0,45 MPa	Standard	IEC 56
Blocking 20°C	0,43 MPa		
Volume per pole	53 l	Year of manufacture	1998

Photo BE

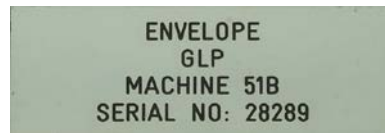

Photo BF

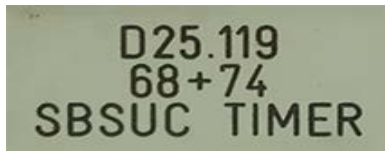

Photo BH

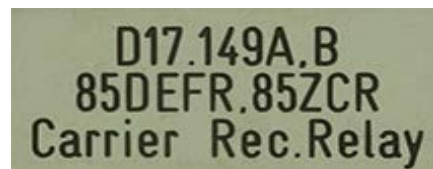

Photo BJ



Photo BL

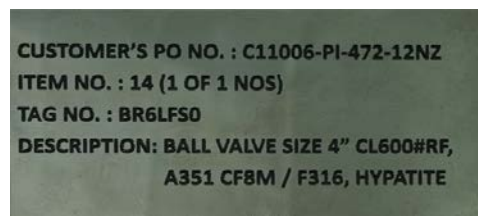
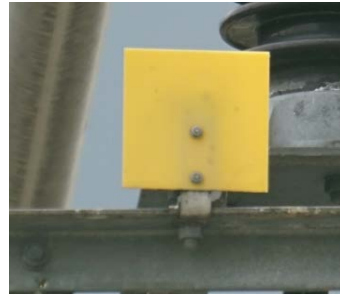

Photo BN

**SIGNAGES / LABEL / NAME PLATE**

## PHASE PLATE

Item Code	Colour	Size (Inch x Inch)
DSSB-SA-PPALB-DBL	Blue	6" x 6"
DSSB-SA-PPALB-R	Red	
DSSB-SA-PPALB-Y	Yellow	
DSSB-SA-PPALB-DBL1212	Blue	12" x 12"
DSSB-SA-PPALB-R1212	Red	
DSSB-SA-PPALB-Y1212	Yellow	



## CPR POSTER

Item Code
DSSB-SA-CPR2030N-DRCAB
DSSB-SA-CPR2030N-DRABC



SIGNAGES / LABEL / NAME PLATE

## REGULATION FIRST AID KITS



### BOX A

For Factories with up to 10 persons employed

<b>Item Code</b>
------------------

DSSB-SA-FAK-BOX-A
-------------------



### BOX B

For Factories with up to 11 to 50 persons employed

<b>Item Code</b>
------------------

DSSB-SA-FAK-BOX-B
-------------------



### BOX B

For Factories with more than 50 persons employed

<b>Item Code</b>
------------------

DSSB-SA-FAK-BOX-C
-------------------





# SAFETY LOCKOUT TAGOUT

## PERSONNEL LOCKOUT TAGOUT

### VINYL COATED HASP

Item Code	A	B	C
VH-25	25mm	113mm	10mm
VH-39	39mm	127mm	10mm

- Die cut section made from solid Heavy gauge steel plate.
- Vinyl coated at the lower portion.
- Inner dia size : 25 mm and 39mm
- Each hasp accomodates up to six locks

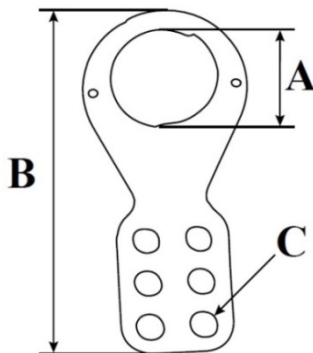

### ELECTRONIC PLATED HASP

Item Code	A	B	C
VH-E25	25mm	112mm	11mm
VH-E39	39mm	127mm	11mm

- Die Cut section made from solid Heavy gauge steel plate.
- Joined with Chrome plated aluminium rivet
- Electroplated body
- Inner dia size : 25 mm and 39 mm
- Each hasp accomodates up tp six locks.

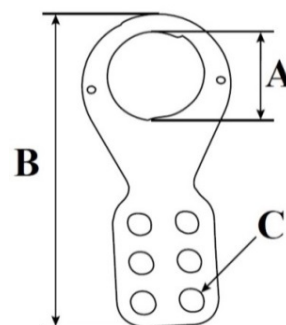

## PERSONNEL LOCKOUT TAGOUT

### NYLON HASP

Item Code	A	B	C
VH-N33	110mm	40mm	3mm
VH-N36	114mm	40mm	6mm

- Injection molded one piece construction.
- Made from Nylon material.
- Can be applied to any instrument for locking out.
- Each hasp accommodates up to three locks.

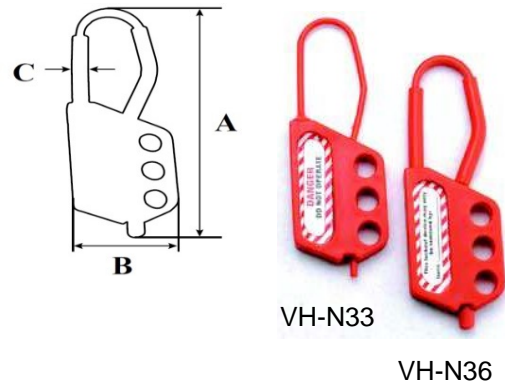

### STAINLESS STEEL HASP

Item Code	A	B	C
VH-SSH	112mm	45mm	5mm

- Material : Stainless Steel.
- Corrosion resistant.
- Holds up to 6 locks.

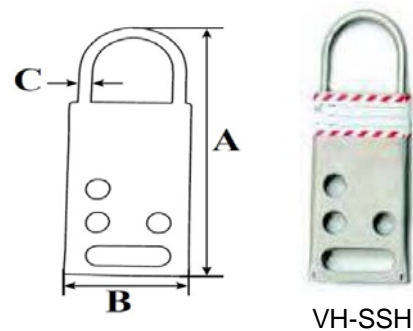

### LOCKOUT TAGS

- Made from superior grade 0.7mm Polyurethane super white sheet.
- Supplied with golden ring for extra strength for holding padlock.
- Tags meets OSHA standards.
- They withstand moisture / grease & dirt.
- Size : 80mm x 140mm with chamfered top corners.



V-T02

PERSONNEL LOCKOUT TAGOUT

## PERSONNEL LOCKOUT TAGOUT

### PREMIER SAFETY PADLOCK

Item Code	Description	A	B	C	D
V-PLSP-KD	Key Different	45mm	38mm	40mm	6mm
V-PLSP-KD+M	Master Key	45mm	38mm	46mm	6mm

- Compliance with OSHA "one employee, one lock, one key" directive.
- Lightweight Special Re-enforced fiber bodies are durable and non-conductive.
- Customize your system with choice of five bright colors.
- Extra clearance steel shackle fits a wide range of lockout applications.
- Ball-bearing locking resists prying.
- Durable, lightweight, non-conductive fiber reinforced lock body permanent write-on labels.
- Key retaining-ensures that padlock is not left unlocked.

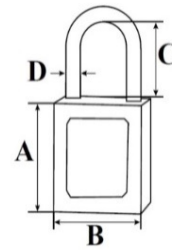

V-PLSP-KD



V-PLSP-KD+M

### STEEL LAMINATED PADLOCK

Item Code	A	B	C	D	E
V-PRS-3A	33mm	43mm	47mm	6mm	25mm

- Maximum security laminated padlocks are made for tough lockout situation.
- Shackle is made of special metal alloy for increase durability against cutting, prying and twisting.
- 5-pin tumber cylinders for additional keying options.
- Padlocks are individually plated for improved corrosion resistance within the lock.
- Set with 3 nos with same key.

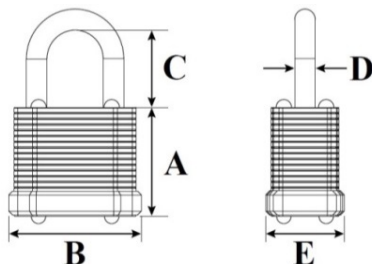

## MECHANICAL LOCKOUT

### GATE VALVE LOCKOUT

Item Code	Hand Wheel Dia.	A	B	C
V-02-GVL	1"-2 <sup>1/2</sup> "(25 to 63.5mm)	77mm	19mm	38mm
V-04-GVL	2 <sup>1/2</sup> "-5"(63.5 to 127mm)	142mm	38mm	43mm
V-06-GVL	5"-6 <sup>1/2</sup> "(127 to 165mm)	175mm	63mm	50mm
V-08-GVL	6 <sup>1/2</sup> "-10"(165 to 254mm)	265mm	87mm	63mm
V-10-GVL	10"-13"(254 to 355mm)	368mm	102mm	75mm

- Virtually indestructible valve covers.
- One locked, they rotate freely around the hand wheel & prevent the valve wheel from being turned.
- The strong polyurethane plastics make them resistant to cracking and abrasion.
- They are resistant to extreme weather and temperature conditions.
- Available in 5 sizes ( Red color) other colors available on request. minimum quantity applicable.

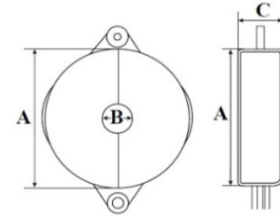

### ADJUSTABLE GATE VALVE LOCKOUT

- This versatile valve hand wheel lockout adjusts to fit valve hand wheels from 25.4mm to 165mm (1" to 6.1/2") diameter.
- Manufactured from durable polypropylene and can withstand temperature changes from -45°C to 182 °C



MECHANICAL LOCKOUT

## MECHANICAL LOCKOUT

### BALL VALVE LOCKOUT

Item Code	Hand Wheel Dia	A	B	C
V-BV 01	$\frac{3}{8}$ " - $1\frac{1}{2}$ "	165mm	78mm	85mm
V-BV 02	$1\frac{1}{2}$ " - $2\frac{1}{2}$ "	208mm	78mm	130mm
V-BV 03	2" - 8"	302mm	100mm	200mm

- Made from Special grade of PVC.
- Virtually indestructible valve covers.
- Once locked, it prevents handle from being turned.
- Resistant to cracking and abrasion.
- They are resistant to extreme weather and temperature conditions.
- Available in 3 sizes.



V-BV 01

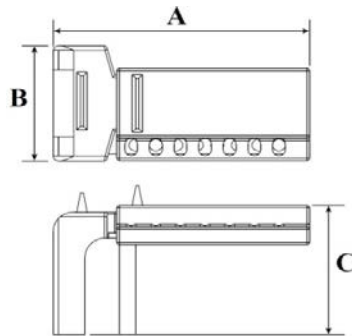

V-BV 02

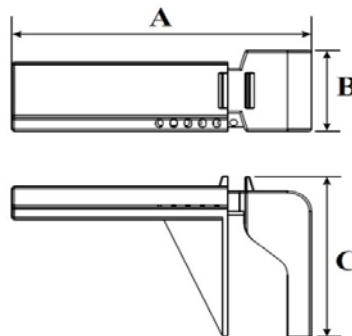

V-BV 03

MECHANICAL LOCKOUT

## MECHANICAL LOCKOUT

### BUTTERFLY VALVE LOCKOUT

- For all types of butterfly valves available internationally.
- The strong polyurethane plastics make them resistant to cracking and abrasion.
- They are resistant to extreme weather and temperature conditions.

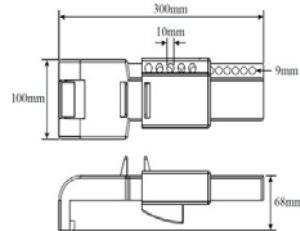

### UNIVERSAL VALVE LOCKOUT

- The Universal Lockout device is a modular system which enables you to lockout valves of different types and sizes.
- No other device offers such flexibility and security.



V-UVL

### MULTIPURPOSE CABLE LOCKOUT

- Ideal for multiple control panel and gate valve lockouts.
- Scientifically made moulded section of PVC.
- 2 meters galvanized steel cable, withstand more than 100 kg weight.
- Accommodates up to 4 locks.



V-UML

## ELECTRICAL LOCKOUT

### MINIATURE BREAKER LOCKOUT

- Safe & Effective method for locking out Miniature Circuit Breaker lockout.
- Push button installation - Does not require any tool for installation.
- Can be applied on all single / Multiple Breakers.
- A Padlock should be applied to Lockout the MCB.



PIN CBL SET ( 3 Different types)



PIN IN CBL - (3pcs)



PIN OUT CBL - (3pcs)



PIN OUT WIDE CBL - (3pcs)



### UNIVERSAL CIRCUIT BREAKER LOCKOUT

- Safe & Effective method for locking out Circuit Breakers.
- With Adjustable Screw.
- It can be used on single & multi - pole breakers.
- Handle size from 7.5mm to 15mm tall and 4mm to 8.9mm thick.





## ELECTRICAL LOCKOUT

### LARGE CIRCUIT BREAKER LOCKOUT

- Locks out a wide range of three phase Circuit Breakers (227V and above).
- Fits on lever of Circuit Breaker up to 3" wide & 0.9" thick.
- Handy Device : make it easy to secure the large Circuit Breakers at any workplace.
- Rugged Stainless steel / PVC Constructions.
- Corrosion resistant.
- Easy installation simply turn the screw with the help of screw driver into the Circuit breaker handle and add your own Padlock and Tag.



V-LCB

### COMBO CIRCUIT BREAKER & FUSE LOCKOUT

- Five type of lockouts for different types of Circuit Breakers and Fuse Holder.
- Application : Clamp onto the Circuit Breaker toggle in the OFF position, using small screwdriver and the set screw in the device.
- Place a padlock through the hole to prevent access to the set screw.



V-CBF-COMCO 5



## ELECTRICAL LOCKOUT

### ELECTRICAL PANELS & SWITCHES LOCKOUT

Item Code	Description	A	B	C
V-CIR-45	ROUND	45	47	50
V-CIR-55	ROUND	55	48	60
V-SQS	SQUARE	60	65	72
V-SQB	SQUARE	85	65	95

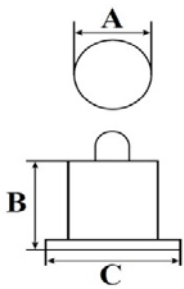

V-CIR-55 V-CIR-45

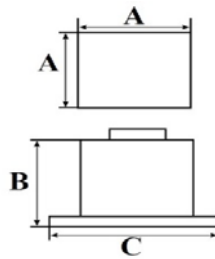

V-SQB V-SQS

### MUSHROOM PANELS & SWITCHES LOCKOUT



V-MSTL

ELECTRICAL LOCKOUT

## ELECTRICAL LOCKOUT

### PLUG / PNEUMATIC LOCKOUT

Item Code	Cable / Hose Dia	A	B	C
V-SPLO	13mm	50mm	52mm	88mm
V-LPLO	8-19mm	92mm	96mm	165mm

- The injection molded superior grade PVC lockout specifically meant to hold inside all kind of sockets that are attached to the chords of various thickness.
- Use with any padlock to keep equipment from being plugged in accidentally.
- Ensure that the plug can't be used until the lock is removed.



V-LPLO

V-SPLO

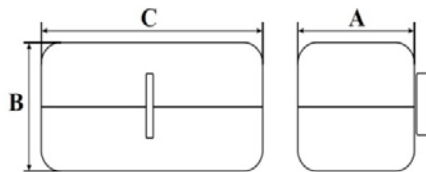

### PLUG / PNEUMATIC LOCKOUT

- Yellow color injection molded electrical lockout.
- Use with any padlock to keep equipment from being plugged in accidentally.
- Enclose the lug so that it can't be used.
- Plug Lockout accomodates high and low-voltage plugs up to 3" in diameter and 5 1/2" in length.
- 2 Sliding top lids can be used individually or together to fit small, medium and large-diameter cords up to 1 1/4".



V-CLO-E



## LOTO STATION / POSTER

### LOCKOUT / TAGOUT STEEL STATION

- Steel with yellow powder coated.
- Adjustable Shelves (2pcs).
- Clear Fascia.
- Dimension : 16"H x 14" W x 6" H



V-LSS16

### LOCKOUT / TAGOUT PVC STATION

- Durable Plastic Material
- Five hangers for Padlocks or hasps.
- Wall Mounted.
- Dimension : 6" x 8".



V-LSP-B

### LOTO POSTER



Poster Size : 610 x 455mm



Poster Size : 610 x 455mm

LOTO STATION / POSTER

## LOTO STATION / POSTER

### ELECTRICAL LOCKOUT KITS-V-ELK

- Combo Miniature Circuit Breaker Lockout / Fuse Lockout(5pcs) - V-CBF-COMBO5 - 1 set.
- PIN type Circuit Breaker lockout (3pcs) CBL-SET- 1 set.
- Mini Universal Circuit Breaker Lockout (with adjustable thumb screw) - V-UBL-SN - 2pcs.
- Large Circuit Breaker Lockout - V-LCB - 1pc.
- Plug / Pneumatic Lockout - V-SPLO - 1pc.
- Plug / Pneumatic Lockout - V-LPLO - 1pc.
- Electrical Plug Lockout Device - Yellow V-CLO-E - 1 pc.
- De Electric Hasp 3 holes / 3mm shackle VH-N33 - 2pcs.
- De Electric Hasp 3 holes / 6mm shackle VH-N36 - 2pcs.
- Electrical Panel Lockout - V-CIR-45 - 1pc.
- Electrical Panel Lockout - V-CIR-55 - 1pc.
- Electrical Panel Lockout - V-SQS - 1pc.
- Electrical Panel Lockout - V-SQB - 1pc.
- Mushroom Push Button Lockout - V-MSTL- 1pc.
- Safety Padlocks, Red - Key Different - V-PLSP-KD - 5 pcs.
- Lockout Tags - 20pcs.
- Electrical Lockout Bag - 1pc.



V-ELK

### ELECTRICAL LOCKOUT KITS-V-VLK

- Gate Valve Lockout - V-GVL-02 - 1pc.
- Gate Valve Lockout - V-GVL-04 - 1pc
- Gate Valve Lockout - V-GVL-06 - 1pc
- Ball Valve Lockout - V-BV01 - 1pc.
- Ball Valve Lockout - V-BV02 - 1pc.
- Universal Butterfly Valve Lockout V-BFV - 1pc.
- Vinyl Coated Hasp - VH-25 - 1pc.
- Vinyl Coated Hasp - VH-39 - 1pc.
- Safety Padlock - V-PRS-3A - 3pcs.
- Multiple Cable Lockout - V-UML - 1pc.
- Safety Lockout Tags - 10ps.
- Valve Kit Lockout Bag - 1pc.



V-VLK

LOTO STATION / POSTER



An ISO 9001:2015 & 14001:2015 Company

# DELTA SAMA JAYA SDN. BHD. (DSSB) (Reg. No: 500276-W)

No. 23G & 23M, DSSB Building, Jalan Perdana 6/8, Pandan Perdana, 55300 Kuala Lumpur, Malaysia

Tel: +603-92824007, +603-92813778 Fax: +603-92870705

Email: (HQ): samajaya@substation.com.my, (Sales): sales@substation.com.my

Website: www.substation.com.my, www.cablecleat.com.my



## NOTES:

Lined area for notes, consisting of 25 horizontal lines.



An ISO 9001:2015 & 14001:2015 Company

# DELTA SAMA JAYA SDN. BHD. (DSSB) (Reg. No: 500276-W)

No. 23G & 23M, DSSB Building, Jalan Perdana 6/8, Pandan Perdana, 55300 Kuala Lumpur, Malaysia

Tel: +603-92824007, +603-92813778 Fax: +603-92870705

Email: (HQ): samajaya@substation.com.my, (Sales): sales@substation.com.my

Website: www.substation.com.my, www.cablecleat.com.my



## NOTES:

Lined area for notes, consisting of 25 horizontal lines.

# Delta Sama Jaya Sdn.Bhd.



**DELTA SAMA JAYA**  
[www.substation.com.my](http://www.substation.com.my)

We are constantly reviewing and updating our products,  
for the latest information please call us on (+603) 9281 3778  
or visit our website at: [www.substation.com.my](http://www.substation.com.my)