

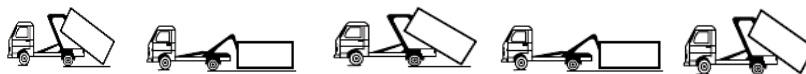

VISION WASTE DISPOSAL SDN BHD

---

# COMPANY PROFILE



*“We care for your environment”*  
*REDUCE, RECYCLE, REUSE*



VISION WASTE DISPOSAL SDN BHD

---

# INTRODUCTION

0

## ZERO WASTE

1

## TEAM

‘Go Green’

With

Vision Waste Disposal Sdn Bhd

*“Cleanliness for healthy environment”*

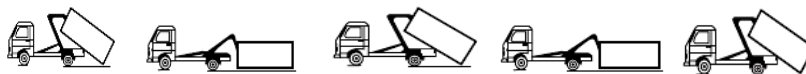

*“We care for your environment”*  
**REDUCE, RECYCLE, REUSE**



## INTRODUCTION OF COMPANY

Vision Well Trading & Engineering has been in service for the past 12 years and was upgraded to Vision Waste Disposal Sdn. Bhd.

Vision Waste Disposal Sdn. Bhd. was incorporated on October 2006, a wholly owned 100 percent Malaysian company.

Vision Waste Disposal Sdn. Bhd. is a professional Integrated Solid Waste Management Services company and is also licensed recycle program, supply recycle bins, garbage bins and all kinds of plastics and metal bins.

Our focus mainly on recycle program (zero waste) and domestic, Institutional, Commercial, Industrial waste and are registered with DBKL, MBSA and other local authorities.

At present, the trustworthiness which our clients always have on us, helped us to attain an extensive growth and now we are more than 50 in our team to carry out our existing jobs. We have even plans to increase our workforce as we prepare expansion of operations to new areas soon.

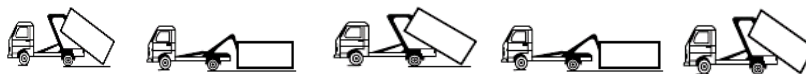

*“We care for your environment”*  
**REDUCE, RECYCLE, REUSE**



## BUSSINESS VALUES AND BELIEFS

- \* COMMITMENT AND DEDICATION TO OUR CUSTOMERS AND TEAM MEMBERS WILL NOT BE COMPROMISED.
  
- \* TRUST AND RESPECT BETWEEN ALL TEAM MEMBERS IS ESSENTIAL TOWARD MEETING OUR GOALS.
  
- \* INTEGRITY AND RESPECT FOR ALL INDIVIDUALS ARE NEVER COMPROMISED.
  
- \* ALLOW CUSTOMERS TO MAKE DECISION AND ALLOW PRESSURE ENVIROMENT BASED FACTS.
  
- \* PROMOTE FAMILY VALUES IN ALL ASPECT OF OUR BUSSINESS.
  
- \* GENERATE ENTHUSIASM BASED ON SATISFACTION FOR CUSTOMERS AND TEAM MEMBERS.

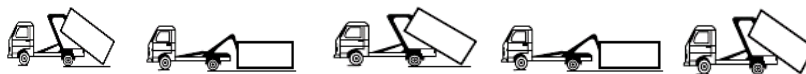

*“We care for your environment”*  
**REDUCE, RECYCLE, REUSE**



---

---

## OUR CORE VALUE OF VWDSB

### VISION WASTE DISPOSAL SDN BHD

#### VISION AND MISSION:-

- V** - **V**alue our customer with attention, consideration and respect
  
- W** - **W**e are customer focused. That means we continuously improve the quality, look feel and image of your place
  
- D** - **D**evelop the company by providing open communication with our customers and employees
  
- S** - **S**ave the Green Environment by 3R services:-  
***REDUCE, RECYCLE, REUSE***
  
- B** - **B**uild and maintain the best. Means providing outstanding quality, services, cleanliness and value for our customer



*“We care for your environment”*  
***REDUCE, RECYCLE, REUSE***



## MISSION STATEMENT

### OUR MISSION

To provide our employees with a safe and superior working environment; a spirit of team effort and rewarding them with the courtesy and respect they deserve.

To create a relationship with our clients by providing them superior services at affordable prices, added value by offering additional services, and do it better than our competitors.

Quality service to our employee and customers are the building blocks of our business philosophy.

### PHILOSOPHY

We believe that building life time relationship with our customers and team members is essential to exceeding our expectations and will resulting the successful accomplishment of our mission.

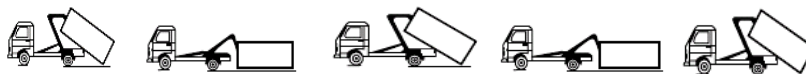

*“We care for your environment”*  
**REDUCE, RECYCLE, REUSE**



## CORPORATE DETAILS

Company Name	:	VISION WASTE DISPOSAL SDN BHD
ROC Number	:	749918-X
Participation Status	:	100 percent Malaysian participation and owned
Bussiness Address	:	No.3-1, Jalan Putra Mahkota 7/5B, Section 7, Pusat Bandar Putra Point, 47650 Subang Jaya, Selangor.
Tel	:	03-5192 3722, 4450, 3314
Fax	:	03-5192 2209, 5944
Hunting Line	:	019-320 8450, 019-270 8450, 019-22 999 33
Authorized Capital	:	RM 500,000.00
Paid Up Capital	:	RM 250,000.00
Company Secretary	:	LSK MANAGEMENT SERVICES SDN BHD
Company Auditors	:	RAJA MANICK & CO
Company Tax Agent	:	R.M TAXATION SERVICES SDN BHD
Bankers	:	MAYBANK , Sek. 20, Shah Alam , Selangor Darul Ehsan.
	:	PUBLIC BANK , USJ 10 , Subang Jaya , Selangor Darul Ehsan.



*“We care for your environment”*  
**REDUCE, RECYCLE, REUSE**



VISION WASTE DISPOSAL SDN BHD

---

# MANAGEMENT PROFILE

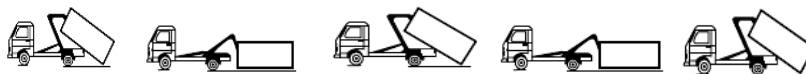

*“We care for your environment”*  
*REDUCE, RECYCLE, REUSE*





## MANAGEMENT PROFILE

MR. STEVAN

General Manager

Nationality: Malaysian

Professional Exposure:

---

Mr.Stevan has been in the industry for more than 20 years now. Starting his career as a small businessman with just a handful of workers, he gradually attained a radical growth in the business by dint of his hard work. He has characteristic skill in team coordination and initiative approach on all packages of waste disposal jobs, renovation and cleaning jobs.

His specialization remain with managing Waste disposal, renovation and cleaning contracts of long term basis where his expertise is of much use in successfully handling of more than 100 jobs to clients satisfaction.

He has successfully handled jobs to clients in Klang Valley and Selangor area. Over the period of time, he accrued a wide knowledge of controlling and coordination team efforts in the industry. His success in Waste disposal, renovation, cleaning and maintenance services management lies in his excellent public relation and client interactions.

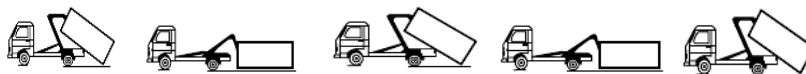

*“We care for your environment”*  
**REDUCE, RECYCLE, REUSE**



## MESSAGE FROM GENERAL MANAGER

Vision Waste Disposal Sdn. Bhd. is a leader in Waste disposal services and cleaning services. We offer an alternative into impersonal companies that rarely perform differently from one another.

We have the management personnel required to do the job. Since we are independently owned and operated, you benefit from my personal interest and daily involvement, as well as that of the supervisory staff.

We hire the right and experienced staff, give them proper specification and precise written work schedules and monitor their performances. We appreciate you are taking the time to consider Vision Waste Disposal Sdn. Bhd.

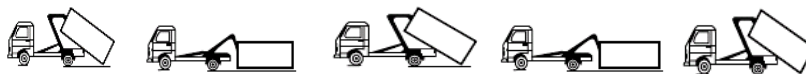

*“We care for your environment”*  
**REDUCE, RECYCLE, REUSE**



## VISION WASTE DISPOSAL SDN BHD ORGANISATION CHART

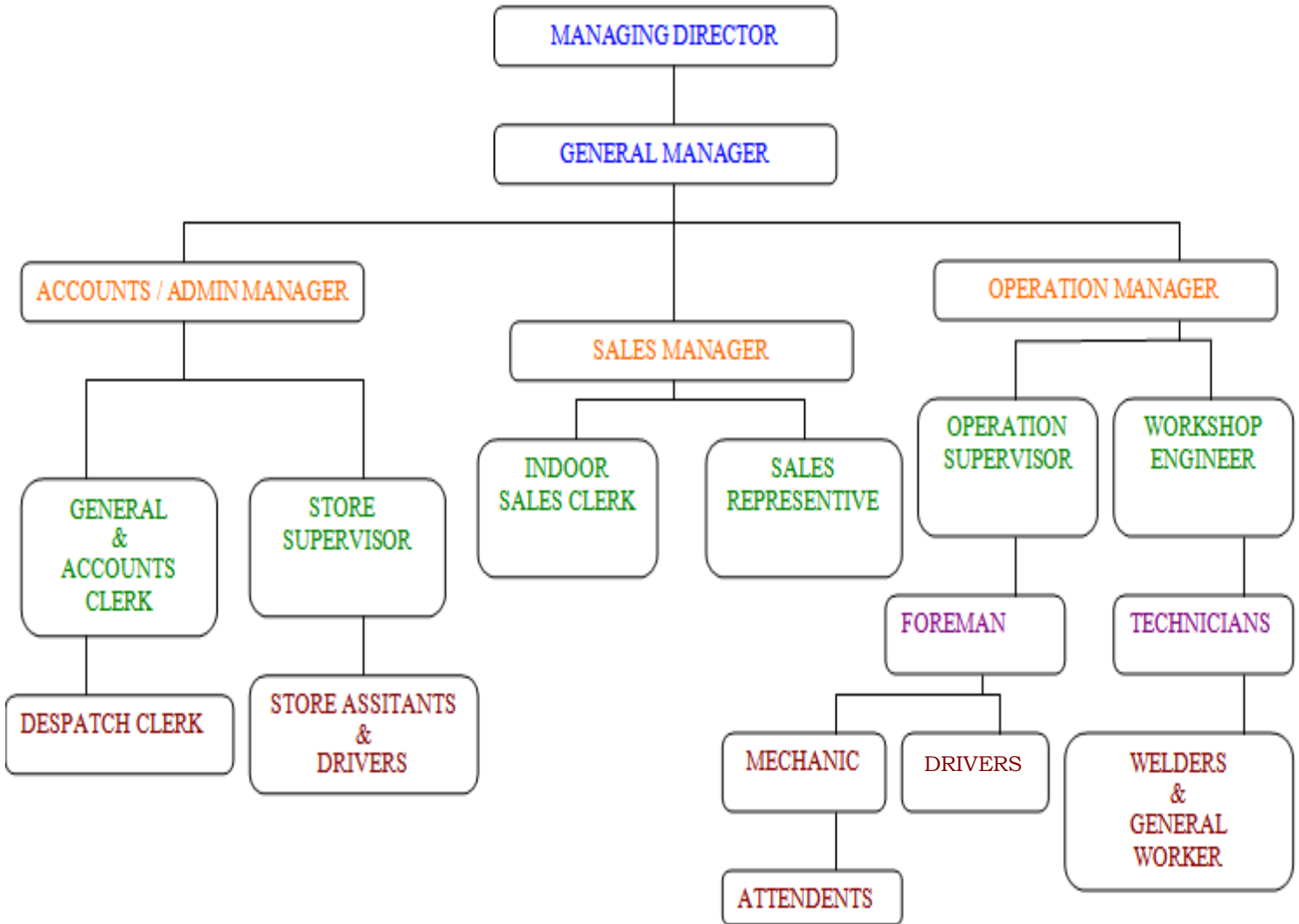

*"We care for your environment"*  
**REDUCE, RECYCLE, REUSE**



## TYPE OF SERVICES PROVIDED

### SOLID WASTE :-

- \* Institutional, Commercial and Industrial Solid Waste Handling.
- \* Construction / Renovation Waste.
- \* Garden, Bulky Waste and Tree / Grass Cutting.
- \* Manufacturer and Importer of Stationary / Portable Waste Compactor.
- \* Supplier of Mobile Garbage Bins, Leach Bins and Industrial Waste Bins.

### LIQUID WASTE :-

- \* Desludging Services.
- \* High Pressure Pipeline Cleaning
- \* CCTV Inspection For Pipelines

### OTHER EQUIPMENTS FOR HIRE :-

- \* Mobile Cranes.
- \* Sky Lifts.
- \* Lorries.

### PROFESSIONAL CLEANING SERVICES :-

- \* Office space, hospitals, clinics, apartments, condominiums, complexes,
- \* Auditoriums, factories, upholstery cleaning, scrubbing, window cleaning, floor
- Cleaning and construction clean up



*“We care for your environment”*  
**REDUCE, RECYCLE, REUSE**



## **SERVICES PROVIDED**

### 1. **WASTE DISPOSAL SERVICES.**

We have vast experience in waste disposal services, with up to date equipments, materials and skillfull workers. We have adequate transportation and manpower to conduct this service to the satisfaction of our clients.

### 2. **GENERAL CONTRACTOR**

The general works includes the sewerage disposal services, buying scrap/recycle material, supply portable toilets & polyethylene or metals bins, office cleaning, liquid disposal, supply & service waste compactors & rollers shutters, transportation, shifting (house & office), landscaping, road works, gardening, grass cutting (tree), turfing, waterfalls, planting, rock gardening, fish ponds, rubbish clearance, premix, house renovation, plumbing & painting, electrical works & instruments etc.

### 3. **LANDSCAPING**

The scope of works includes the maintenance of all hard and soft landscape, such as weeding, pruning, fertilizing. Application of insecticides where necessary, moving of grass and other general horticultural works to ensure healthy growth of plants. We have vast experience in turfing workers which includes preparation of top ground, watering, weeding, rolling and maintenance.

### 4. **PAINING WORKS**

Painting also being done by our company. We have the expertise in painting buildings and car park, inclusive of rise high Buildings.

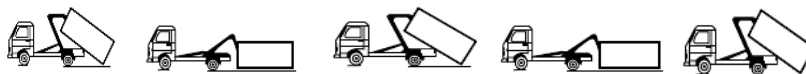

*“We care for your environment”*  
**REDUCE, RECYCLE, REUSE**



## RECYCLING GLASS CRUSHER

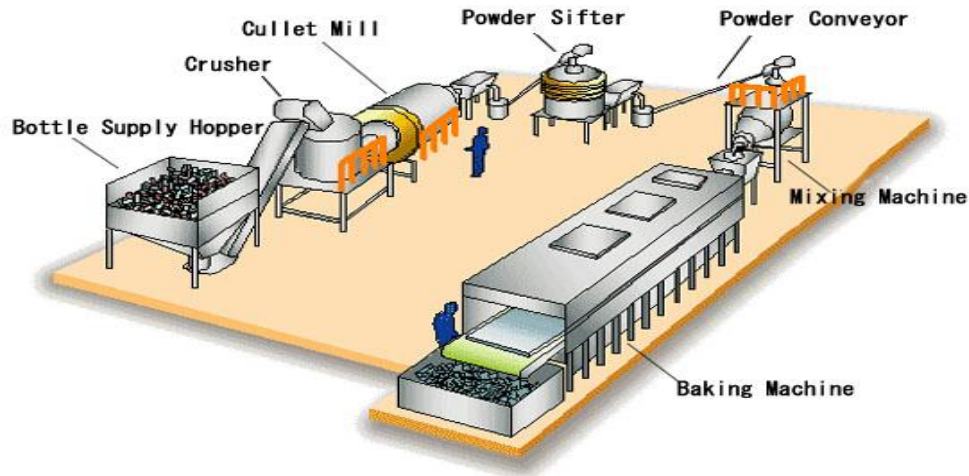

### □ Glass Recycling Process:

local bottle banks >> collection >> loading >> manual sorting  
>> crushing & screening >> ferrous metal removal >> stone and ceramic removal >> vacuuming >> none ferrous metal removal  
>> small ceramic & stone removal >> final visual check >> transfer to holding bay



### *Good For The Environment*

A glass bottle that is sent to landfill can take up to a million years to break down. By contrast, it takes only 30 days for a recycle bottle to leave your factory recycling bin and appear as a new glass container. Even it can be recycled repeatedly, again and again, with no loss of purity or quality in the glass.

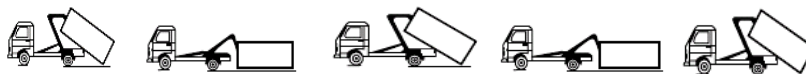

*“We care for your environment”*  
**REDUCE, RECYCLE, REUSE**



*Glass Crusher Machine*

**RECYCLING PLASTIC**

Plastic is an artificial substance designed for human needs, so it is difficult for the environment to completely integrate. Much of the plastic thrown away languishes in landfills for decades with no respite. Recycling is one key to removing most of it from the environment, but there is no unanimity among the types of plastic that are manufactured. There are six distinct types of resin that directly translate into six individual codes, plus one catch-all category. These include, in order of their code, polyethylene terephthalate, high density polyethylene, polyvinyl chloride, low density, polyethylene, polypropylene and polystyrene. Polyethylene is the most popular resin.

Some resins may be stronger or more flexible than others. Certain resins may be linked to health problems. Not all of them are efficacious for recycling.

*PLASTIC RECYCLING MACHINE*



*Loading the plastic into the machine*



*Plastic Baler Machine for small volume*

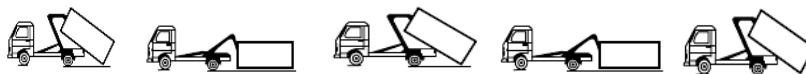

*“We care for your environment”*  
**REDUCE, RECYCLE, REUSE**



*Compact the plastic for recycle purpose*

## **RECYCLING CARTON BOXES & PAPERS**

Paper cartons are everywhere, many of these cartons can be recycled, saving materials and preventing waste. There are many types of paper cartons. Corrugated cardboard is a very common material which can be recognized by the wavy lines you see inside the cardboard at the cut edges. Other materials include chipboard or boxboard, which is used to make cereal packets. Additionally, food and drink containers are often made of cardboard with a plastic or wax coating.

Recycling paper and other materials has a number of benefits. Recycled cartons don't end up in landfill, reducing the amount of waste that's dumped. Recycling also saves trees from being cut down to make new paper, and is more energy efficient, using between 28 and 70 percent less energy.

### **Carton baler process**



### **Baler Machine for small volume**



*“We care for your environment”*  
**REDUCE, RECYCLE, REUSE**





COLLECT P&C  
PAPER WASTE  
FROM WASTE  
BIN AT  
CUSTOMER'S  
SITE



TRANSFER P&C PAPER WASTE FROM  
WASTE BIN TO WASTE TRUCKS  
(WE CAN PROVIDE WASTE PLASTIC  
BAGS,CABLE TIE TO TIE UP THE WASTE  
PLASTIC BAGS AND TYPE OF WASTE BIN  
REQUEST BY CUSTOMER )



SHRED P&C PAPER WASTE –  
THROUGH RM 1 MILLION  
SOFISTICATED SHREDDING  
MACHINE IN OUR FACTORY



TRANSPORT P&C  
PAPER WASTE TO  
FACTORY



**HIGHLY SOFISTICATED SHREDDING  
MACHINE**

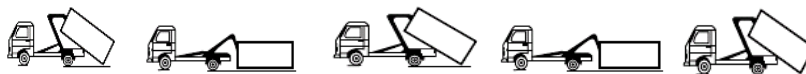

*“We care for your environment”*  
**REDUCE, RECYCLE, REUSE**



## RENTAL AND SUPPLY SERVICE FOR SHREDDING MACHINE

We provide rental for shredding machine with very competitive rental rate with the latest shredding machine in market.

FIRST CLASS QUALITY  
FIRST CLASS GUARANTEE



## DESIGN AND FUNCTION



EBA 2125 S / EBA 2125 C



EBA 2226 S / EBA 2226 C



EBA 2239 S / EBA 2239 C



EBA 5140 S / EBA5140 C



*“We care for your environment”*  
**REDUCE, RECYCLE, REUSE**



VISION WASTE DISPOSAL SDN BHD



- **One of our new truck came back to store. Our potential worker is pumping the Used Cooking Oil to our store IBC tank waiting to do advance process.**



- **Our potential Worker is clearing and filtering all the sludge and dirt in our store. Our store capacity can attain 80mts of Used Cooking Oil. Every month the Team of Excel Criterion can collect over 150mts Used Cooking Oil at KL market.**

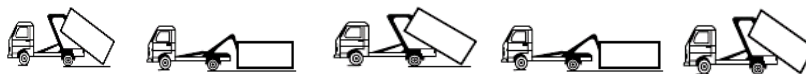

***“We care for your environment”  
REDUCE, RECYCLE, REUSE***



VISION WASTE DISPOSAL SDN BHD



- ***Our potential worker trained our new player to make sure our product is 100% clear and in the best condition. Once our store attain certain level of oil so our main organization will sent a tanker come to do collection.***



- ***Our experience worker will take sample after they load the oil to make sure our oil is in best condition and without any water, sludge and dirt.***

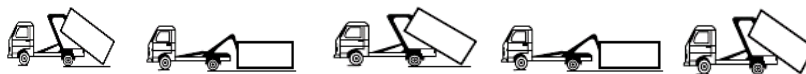

***“We care for your environment”  
REDUCE, RECYCLE, REUSE***



8 TON TRUCK LORRY - COLLECT MILK POWDER



SL -10N Hook lift c/w rear stabilizer



*"We care for your environment"*  
**REDUCE, RECYCLE, REUSE**



CLOSED WASTE BIN - FACTORY WASTE



Completed Product for Shipment



*"We care for your environment"*  
**REDUCE, RECYCLE, REUSE**



1

**AMROLL LORRY "Roll-on Roll-off" Hook Lift – 24 CUBIC YARDS CAPACITY OPEN BIN**



“Roll-on Roll-off” Hook-lift can be used with a Garbage container, Waste collection at industrials area, hotels and construction site.

2

**PORTABLE COMPACTOR LORRY – 24 CUBIC YARDS CAPACITY**



Suitable for Condominium, Public Housing project with a common garbage area, Commercial Buildings, Food court, Hawker Centers, Hotels and Hypermarkets where majority of solid waste generated are household waste.

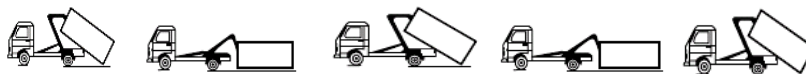

*“We care for your environment”*  
**REDUCE, RECYCLE, REUSE**



*Sludge /Jetter Truck*

**LIQUID WASTE:-**

- Desludging Services
- High Pressure Pipeline Cleaning
- CCTV Inspection for Pipelines



*“We care for your environment”*  
**REDUCE, RECYCLE, REUSE**





**MANUFACTURE BINS FOR SALE AND RENTAL**

**TYPE OF RORO BIN AND WASTE DISPOSAL SERVICES**



**12 CUBIC YARDS RORO OPEN BIN**  
(12'L X 6'W X 4'H)



**22CUBIC YARDS RORO OPEN BIN**  
(18'L X 8'W X 4'H)



**8 CUBIC YARDS (CONSTRUCTION BIN)**  
(12'L X 6'W X 2.5'H)



**24 CUBIC YARDS PORTABL COMPACTOR**  
(16'L X 5'W X 6'H)

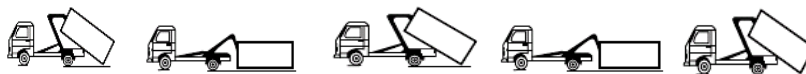

***“We care for your environment”***  
***REDUCE, RECYCLE, REUSE***



VISION WASTE DISPOSAL SDN BHD

---

# LICENCE & REGISTRATION



*“We care for your environment”*  
**REDUCE, RECYCLE, REUSE**



CERTIFIED TRUE COPY

SURUHANJAYA SYARIKAT MALAYSIA  
COMPANIES COMMISSION OF MALAYSIA

LOO HOEK LONG  
MAJISA 702726  
COMPANY SECRETARY

**BORANG 9  
AKTA SYARIKAT 1965**

[Seksyen 16(4)]

No. Syarikat

749918

X

**PERAKUAN PEMERBADANAN SYARIKAT SENDIRIAN**

Adalah diperakui bahawa

**VISION WASTE DISPOSAL SDN BHD**

telah diperbadankan di bawah Akta Syarikat 1965, pada dan mulai dari  
09 haribulan Oktober 2006, dan bahawa syarikat ini adalah sebuah syarikat  
berhad menurut syer dan bahawa syarikat ini adalah sebuah syarikat sendirian.

Dibuat di bawah tandatangan dan meterai saya di Kuala Lumpur  
pada 09 haribulan Oktober 2006.

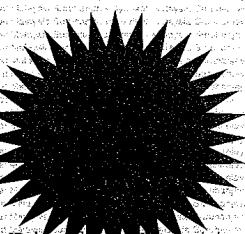

*[Signature]*  
**RUTEH BINTI MAHMOOD**  
PENOLONG-PENDAFTER SYARIKAT  
MALAYSIA

UserID: layan Date: 10/9/2006 12:47:52 PM

NO. SIRI-SSM 336757



*"We care for your environment"*  
**REDUCE, RECYCLE, REUSE**



**MAJLIS PERBANDARAN SUBANG JAYA**  
PERSIARAN PERPADUAN USJ 5, 47610 UEP SUBANG JAYA, SELANGOR DARUL EHSAN.



**LESEN PERNIAGAAN**

**22/03/2016**



2120120300059

NO. AKAUN : 2120120300059  
NO. FAIL RUJUKAN : 2120120300059  
NAMA SYARIKAT : VISION WASTE DISPOSAL SDN BHD  
(KRISHNAMOOTHY A/L MUTHU)  
NO. DAFTAR SYARIKAT : 749918X  
ALAMAT PERNIAGAAN : NO 3 JLN PUTRA MAHKOTA 7/5B,  
SEK 7, PUTRA HEIGHTS,  
47650 UEP SUBANG JAYA  
SELANGOR D. EHSAN  
TARIKH TAMAT : 22 MAC 2016

GAMBAR  
PEMEGANG  
LESEN

**BUTIRAN LESEN**

KOD HASIL	JENIS LESEN	BAYARAN
71410	Stor	RM 180.00
71408	Pejabat urusan (<130 m.p.s. -20' x 70' atau 1 lot) (Kontraktor Pengangkutan Sampah)	RM 180.00

- Lesen ini hendaklah dipamerkan di premis perniagaan dan hendaklah diperbaharui sebelum tamat tempohnya.
- Lesen Perniagaan boleh diperbaharui 3 bulan sebelum tarikh tamat lesen.

JUMLAH PERLU DIBAYAR **RM 360.00**

MPSJ 20 73223 LESEN 17/02/2015 10:12  
141365 2120120300059 RM360.00 4966230230910165  
**YANG DIPERTUA**  
**MAJLIS PERBANDARAN SUBANG JAYA**

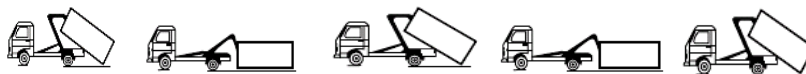

*"We care for your environment"*  
**REDUCE, RECYCLE, REUSE**



**KEMENTERIAN KEWANGAN MALAYSIA**

**SIJIL AKUAN PENDAFTARAN SYARIKAT**

NO SIJIL : K22036060931243939  
NO RUJUKAN PENDAFTARAN : 357-02091623  
TEMPOH SAH LAKU : 13/01/2014 - 12/01/2017

Bahawa dengan ini diperakui syarikat :

VISION WASTE DISPOSAL SDN BHD (749918-X)  
NO.3-1, JALAN PUTRA MAHKOTA 7/5B,  
PUTRA HEIGHTS, SEKSYEN 7,  
PETALING  
47650 SUBANG JAYA  
SELANGOR, MALAYSIA

Telah berdaftar dengan Kementerian Kewangan Malaysia dalam bidang bekalan/perkhidmatan di bawah sektor, bidang dan sub-bidang seperti di Lampiran A. Kelulusan ini adalah tertakluk kepada syarat-syarat seperti yang dinyatakan di Lampiran B. Individu yang diberi kuasa oleh syarikat bagi urusan perolehan Kerajaan adalah seperti berikut :

UMA A/P EUTTAMARAJAH	780729085046	FINANCE CONTROLLER
VISVALINGAM A/L SUNDAR RAJU	830512715003	MANAGER
KRISHNAMOOTHY A/L MUTHU	650807085805	GENERAL MANAGER

tt

**DATO' HASHMUDDIN BIN MOHAMMAD**

Bahagian Perolehan Kerajaan  
h.p Ketua Setiausaha Perbendaharaan  
Kementerian Kewangan Malaysia

Tarikh Berdaftar Dengan Kementerian Kewangan Malaysia : 13/01/2014

(Sijil ini adalah cetakan komputer dan tidak memerlukan tandatangan)

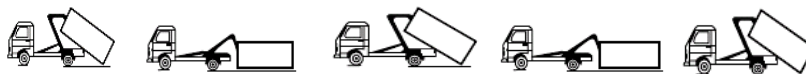

*"We care for your environment"*  
**REDUCE, RECYCLE, REUSE**



LAMPIRAN A

NO SIJIL : K22036060931243939  
NO RUJUKAN PENDAFTARAN : 357-02091623  
TEMPOH SAH LAKU : 13/01/2014 - 12/01/2017

BIL	TARIKH DAFTAR BIDANG	KOD BIDANG	KETERANGAN	STATUS
1	13/01/2014	020403	BAHAN PENCUCI DAN PEMBERSIHAN	Aktif
2	13/01/2014	020501	BAHAN PEMBUNGKUSAN BEKAS/KOTAK/PALET	Aktif
3	13/01/2014	070303	PERALATAN DAN KELENGKAPAN PERTANIAN/TERNAKAN/AKUATIK	Aktif
4	13/01/2014	080101	KELENGKAPAN/KEMUDAHAN AWAM	Aktif
5	13/01/2014	130101	MESIN DAN KELENGKAPAN BENGKEL	Aktif
6	13/01/2014	210201	ALAT PERHUBUNGAN	Aktif
7	13/01/2014	221002	MEMBERSIH KAWASAN	Aktif
8	13/01/2014	221003	MENGANGKAT SAMPAH	Aktif

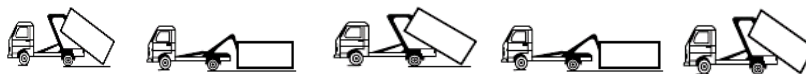

*“We care for your environment”*  
**REDUCE, RECYCLE, REUSE**



MBSA 22/12/2014 4:45 pm 099090220020004

RM #####60.00 SCA Q/PSALWAH\*W/ML4\* R/W####428474



NORAZURA BINTI MOHD NAILAN 22/12/2014 04:29:55 pm

## MAJLIS BANDARAYA SHAH ALAM

# LESEN 2015



### BUANG SAMPAH

NO. AKAUN LESEN : 099090220020004  
NO.KP/PENDAFTARAN : LKP02566 / 749918X  
NAMA : VISION WASTE DISPOSAL SDN. BHD.

ALAMAT : NO. 6, JALAN UTAMA 2/12,  
TAMAN PERINDUSTRIAN PUCHONG,  
47100 PUCHONG



TARIKH TAMAT LESEN : **31 DISEMBER 2015**

No. Fail : MBSA/LSP/LS/600-4/1/305

KOD HASIL	BUTIRAN	BIL	BAYARAN
71902	LESEN PEMBUANGAN SAMPAH SARAP	1	60.00
		JUMLAH	RM 60.00

DATUK BANDAR  
MAJLIS BANDARAYA SHAH ALAM

LESEN INI DIAKUI SAH SELEPAS PEMBAYARAN DICETAK DI BIL INI



*"We care for your environment"*  
**REDUCE, RECYCLE, REUSE**



**PERBADANAN PENGURUSAN SISA PEPEJAL DAN PEMBERSIHAN AWAM**  
KEMENTERIAN KESEJAHTERAAN BANDAR, PERUMAHAN DAN KERAJAAN TEMPATAN  
WISMA UOA PANTAI, TINGKAT MEZZANINE, 2, 3 DAN 4,  
NO. 11, JALAN JAYA (JALAN 4/83A) PETI SURAT 12038, 59200 KUALA LUMPUR.  
TEL : 03-2245 9292 FAX : 03-2245 9293 EMEL : ppsppa@sisa.my WEB : www.ppsppa.gov.my



Rujukan Tuan :  
Rujukan Kami : PSP.BSB.600-6 Jld 2 ( 73 )  
Tarikh : 11 Julai 2013

**Vision Waste Disposal Sdn Bhd**  
3-1, Jalan Putra Mahkota 7/5B  
Pusat Bandar Putra Point  
Seksyen 7, Putra Heights  
47650 Subang Jaya  
**SELANGOR DARUL EHSAN**

Tuan,

#### TAPAK PELUPUSAN SISA PEPEJAL PEMBINAAN YANG DIBENARKAN

Dengan segala hormatnya saya diarah merujuk kepada perkara tersebut di atas.

2. Untuk makluman tuan/puan, Perbadanan Pengurusan Sisa Pepejal dan Pembersihan Awam (PPSPPA) di bawah Kementerian Kesejahteraan Bandar, Perumahan dan Kerajaan Tempatan (KKBPKT) telah diberi tanggungjawab dalam pengurusan sisa pepejal dan pembersihan awam di Malaysia melalui **Akta Perbadanan Pengurusan Sisa Pepejal dan Pembersihan Awam 2007 (Akta 672)**. Salah satu sisa pepejal terkawal di bawah Akta 672 ialah sisa pepejal pembinaan yang dijana daripada tapak-tapak projek pengubahsuaian, pembinaan baru dan perobohan. Sisa pepejal ini hendaklah diurus dengan baik dan dihantar ke tapak pelupusan yang dibenarkan.

3. Masalah pembuangan sisa pepejal secara haram di kawasan Kuala Lumpur berada pada tahap yang membimbangkan. Oleh itu Perbadanan telah menetapkan hanya **3 tapak pelupusan sisa lengai** yang dibenarkan untuk melupus sisa pepejal pembinaan. Nama tapak pelupusan yang dimaksudkan dan lokasinya adalah seperti di **Lampiran A**.

4. Sekiranya pihak tuan/puan ingin melupuskan sisa bagi tujuan penambakan tanah, tuan/puan hendaklah memaklumkan kepada pihak Perbadanan secara bertulis dan melampirkan bersama surat kelulusan daripada Pihak Berkuasa Tempatan (PBT) atau daripada agensi-agensi berkaitan termasuk Pejabat Tanah & Galian (PTG)



IBU PEJABAT Tel: 03-2245 9292  
JOHOR Tel: 07-222 6476

SELANGOR Tel: 03-5510 6122  
PERLIS Tel: 04-976 9834  
PAHANG Tel: 09-566 3151

KUALA LUMPUR Tel: 03-2245 9292  
PERAK Tel: 05-241 1619  
TERENGGANU Tel: 09-622 0712

NEGERI SEMBILAN Tel: 06-763 6030  
PULAU PINANG Tel: 04-226 8876  
KELANTAN Tel: 09-747 0909

MELAKA Tel: 06-283 8953  
KEDAH Tel: 04-735 4286



*"We care for your environment"*  
**REDUCE, RECYCLE, REUSE**





PERKARA : TAPAK PELUPUSAN SISA PEPEJAL PEMBINAAN YANG DIBENARKAN  
TARIKH : 11 JULAI 2013

5. Jika pihak tuan/puan didapati membuang sisa pepejal di tempat yang tidak dibenarkan, pihak Perbadanan mempunyai kuasa untuk mensabitkan kesalahan di bawah **Seksyen 72 (Akta Pengurusan Sisa Pepejal dan Pembersihan Awam 2007 (Akta 672))** yang boleh didenda tidak kurang daripada **RM10,000 dan tidak melebihi RM100,000 atau dipenjarakan dalam tempoh tidak melebihi 5 tahun atau kedua-duanya sekali.**

6. Sehubungan dengan itu, kerjasama daripada pihak tuan/puan dalam memastikan negara kita berada dalam keadaan bersih dan sihat amatlah dihargai dan diucapkan terima kasih.

Sekian.

“BERKHIDMAT UNTUK NEGARA”

“AMALKAN KITAR SEMULA, SELAMATKAN BUMI KITA”

“BERSIH, SIHAT DAN SELAMAT”

Saya yang menurut perintah,

(DR. MOHD PAUZE BIN MOHAMAD TAHA)

b/p : Ketua Pegawai Eksekutif

Perbadanan Pengurusan Sisa Pepejal dan Pembersihan Awam

Kementerian Kesejahteraan Bandar, Perumahan dan Kerajaan Tempatan

(Sila catat rujukan kami apabila berhubung)

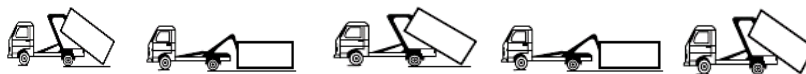

“We care for your environment”  
**REDUCE, RECYCLE, REUSE**



LAMPIRAN A

Bil	Nama tapak pelupusan yang dibenarkan	Alamat	GPS Koordinat	
			Latitude	Longitude
1	Tapak Pelupusan Sisa Lengai Dengkil	Lot 557, Timah Langat, Mukim Dengkil, Sepang Selangor	2.869375	101.648362
2	Tapak Pelupusan Sisa Lengai Kuang	Lot 2712, Mukim Kuang, Gombak, Selangor	3.256593	101.563493
3	Tapak Pelupusan Sisa Lengai Sungai Kertas	Lot 46265, Kampung Sungai Kertas, Gombak, Selangor	3.26418	101.687361



*“We care for your environment”*  
**REDUCE, RECYCLE, REUSE**



**JABATAN PENGURUSAN SISA PEPEJAL NEGARA**

KEMENTERIAN PERUMAHAN DAN KERAJAAN TEMPATAN

ARAS 23 & 24

NO. 51, PERSIARAN PERDANA

PRESINT 4

62100 PUTRAJAYA

Telefon : 03-8891 5000

Faks (Pentadbiran) : 03-8891 3190

Kawat : "MINRUMAH"

<http://www.kpkt.gov.my>



"KITAR SEMULA - FIKIR DULU SEBELUM BUANG"

Ruj. Kami : KPKT/JPSPN/1008/KT/SG120( 4 )

Tarikh : 9/ Julai 2012



**VISION WASTE DISPOSAL SDN. BHD.** (749918-X)

Waste Disposal - MBSA & DBKL Registered Contractor

No. 3-1, Jalan Putra Mahkota 7/5B, Pusat Bandar Putra Point,  
Section 7, Putra Heights, 47650 Subang Jaya, Selangor D. E., Malaysia.

Tel: 03-5192 3722 Fax: 03-5192 2209 H/P: 019-320 8450

Website: [www.visionwaste.com.my](http://www.visionwaste.com.my)

E-mail: [mail@visionwaste.com.my](mailto:mail@visionwaste.com.my)

Tuan,

**PENDAFTARAN AKTIVITI PENGURUSAN SISA PEPEJAL DAN PEMBERSIHAN AWAM  
- Perkhidmatan Pemungutan Sisa Pepejal**

Saya dengan hormatnya merujuk kepada permohonan pendaftaran aktiviti Pengurusan Sisa Pepejal dan Pembersihan Awam melalui nombor penyerahan: **BL2012000975**.

2. **Sukacita** dimaklumkan bahawa perkhidmatan yang dijalankan oleh pihak tuan telah **didaftarkan** seperti berikut :

Bil.	Perkhidmatan Pemungutan Sisa Pepejal	Negeri / Kawasan Perkhidmatan
1	Sisa Pepejal Komersial	Wilayah Persekutuan Kuala Lumpur
2	Sisa Pepejal Pembinaan	Wilayah Persekutuan Kuala Lumpur dan Negeri Sembilan
3	Sisa Pepejal Perindustrian	Wilayah Persekutuan Kuala Lumpur

3. Nombor pendaftaran tuan adalah **KPKT/JPSPN/1008/KT/SG120**. Pihak tuan perlu menggunakan nombor pendaftaran ini semasa membuat permohonan lesen bagi Perkhidmatan Pemungutan Sisa Pepejal pada tarikh yang akan diumumkan kelak.

Sekian, terima kasih.

**"BERKHIDMAT UNTUK NEGARA"**

**"1 MALAYSIA: RAKYAT DIDAHULUKAN, PENCAPAIAN DIUTAMAKAN"**

Saya yang menurut perintah,

**(DATO' NADZRI BIN YAHAYA, Ph.D)**

Ketua Pengarah

Pengurusan Sisa Pepejal dan Pembersihan Awam

Kementerian Perumahan dan Kerajaan Tempatan

(Sila catat rujukan kami apabila berhubung)



*"We care for your environment"*  
**REDUCE, RECYCLE, REUSE**



SHAH ALAM TRANSFER STATION (SATS).



Tipping Fee

Types of Waste	Tipping Fee
Domestic & Commercial Waste	RM 90.00/Ton
Others	TBA

Acceptable Waste

- : Domestic waste but not sanitary waste
- : Food waste from restraints and canteen waste but not contaminated, confiscated, reject, or expired food/ drink wastes;
- : Paper;
- : Polythene/polystyrene;
- : Cardboard
- : Market waste
- : General litter;
- : Cans;
- : Glass/bottles;
- : Builders rubble but not demolition waste;
- : Green waste but not tree trunks;
- : Wood pallets;
- : Expired/Damage Non-Hazardous Product

Non-Acceptable Waste

- : Clinical, chemical, ventinary, liquid, oils, medicine/drugs, greases, acids, sludges, radioactive, solvents, resins, powders, paints, electronic wastes or anything that is considered to be hazardous/toxic or defined as scheduled waste by the Department of Environment (DOE)

Minimum Charge

: Minimum charge of 0.5 tonne per load

Contact Person

- : Mr. Noor Azam Mastor  
Business Development Manager  
019-2271017 / [azam@whb.com.my](mailto:azam@whb.com.my)
- : Mr. Muhd Soffian Mohd Yusof  
Project Development Executive  
019-2208986 / [soffian@whb.com.my](mailto:soffian@whb.com.my)

Operational Hours

Day	Operation Hour
Monday – Saturday	8.00 am – 7.00 pm
Sunday & Public Holiday	8.00 am – 5.00 pm

Notes:

- : The company reserves the right to refuse entry to any truck that is carrying or in part prohibited waste and will make the necessary incident report to the DOE.
- : The rules and instructions set out as per our "SITE RULES AND SAFETY FOR LANDFILL USERS" should be complied.



*"We care for your environment"*  
**REDUCE, RECYCLE, REUSE**



Jeram Sanitary Landfill (JSL).



Tipping Fee

Types of Waste	Tipping Fee
Domestic & Commercial Waste	RM 50.00/Ton
Others	TBA

Acceptable Waste

- : Domestic waste but not sanitary waste
- : Food waste from restraints and canteen waste but not contaminated, confiscated, reject, or expired food/ drink wastes;
- : Paper;
- : Polythene/polystyrene;
- : Cardboard
- : Market waste
- : General litter;
- : Cans;
- : Glass/bottles;
- : Builders rubble but not demolition waste;
- : Green waste but not tree trunks;
- : Wood pallets;
- : Expired/Damage Non-Hazardous Product

Non-Acceptable Waste

- : Clinical, chemical, ventinary, liquid, oils, medicine/drugs, greases, acids, sludges, radioactive, solvents, resins, powders, paints, electronic wastes or anything that is considered to be hazardous/toxic or defined as scheduled waste by the Department of Environment (DOE)

Minimum Charge

: Minimum charge of 0.5 tonne per load

Witness Charge

: RM 200.00/Load (If Any)  
(Witness Certificate & Disposal Picture)

Contact Person

: Mr. Noor Azam Mastor  
Business Development Manager  
019-2271017 / [azam@whb.com.my](mailto:azam@whb.com.my)

: Mr. Muid Soffian Mohd Yusof  
Project Development Executive  
019-2208986 / [soffian@whb.com.my](mailto:soffian@whb.com.my)

Operational Hours

Day	Operation Hour
Monday – Saturday	7.00 am – 8.00 pm
Sunday	8.00 am – 4.00 pm
Public Holiday	8.00 am – 5.00 pm

Notes:

- : The company reserves the right to refuse entry to any truck that is carrying or in part prohibited waste and will make the necessary incident report to the DOE.
- : The rules and instructions set out as per our "SITE RULES AND SAFETY FOR LANDFILL USERS" should be complied.



*"We care for your environment"*  
**REDUCE, RECYCLE, REUSE**



Location	:	Lot 2958,2959 & 1598 Tuan Mee Estate, Jeram, Kuala Selangor
Operation	:	Worldwide Landfills Sdn Bhd
Current status	:	Operation
Design Capacity	:	1,250 tonne per day/8 million cubic meter airspace
Design Lifespan	:	16 years
Current Capacity	:	2,000 tonne per day
Area	:	160 acres
Concession	:	25 years with State Government of Selangor
Date of commencement	:	1 <sup>st</sup> January 2007
Site Facilities	:	Waste Reception Area Site office Weighbridge office Weighbridge Leachate Treatment Plant Buy Back Centre Waste Cell Gas Flaring Unit
Type of waste received	:	Domestic waste (95%), Others (5%)
Tipping Fee	:	Private : RM 50.00 per tonne, Special : RM 141.66 per tonne (Average)



*“We care for your environment”*  
**REDUCE, RECYCLE, REUSE**



SURUHANJAYA SYARIKAT MALAYSIA  
COMPANIES COMMISSION OF MALAYSIA



**PERAKUAN PENDAFTARAN  
AKTA PENDAFTARAN PERNIAGAAN 1956**

BORANG D (KAEDAH 13)

No. Pendaftaran

001379793-T

**MSB SCRAP METAL  
LOT 11347, PERINGKAT 3, JALAN MELOR 3, SG KANTAN  
43000 KAJANG  
SELANGOR**

Dengan ini diperakui bahawa Perniagaan yang dijalankan dengan nama

**MSB SCRAP METAL**

telah didaftarkan dari hari ini sehingga **14 JANUARI 2014** menurut peruntukan-peruntukan Akta Pendaftaran Perniagaan 1956, dengan nombor yang ditunjukkan di sini dan tempat utama perniagaannya di **NO. 357-A, JALAN SUNGAI BESI, BATU 3 1/2, 57100 KUALA LUMPUR, WILAYAH PERSEKUTUAN** dan cawangan-cawangan di :

LOT 11347, PERINGKAT 3, JALAN MELOR 3, SG KANTAN, 43000 KAJANG, SELANGOR

Jenis Perniagaan

MEMBELI DAN MENJUAL BARANG-BARANG LUSUH

Bertarikh di **KUALA LUMPUR** pada **5 APRIL 2013**.

**MOHD NAIM DARUWISH**

Pendaftar Perniagaan Semenanjung Malaysia

UserID: imurni Date: Fri Apr 05 16:39:35 MYT 2013



*"We care for your environment"*  
**REDUCE, RECYCLE, REUSE**



VISION WASTE DISPOSAL SDN BHD



## **MSB SCRAP METAL**

*IMPORT & EXPORT OF FERROUS & NON-FERROUS METALS, PLASTIC, WASTE PAPER & ETC.*



### **OUR SERVICES**

- Collection Service
- Top prices guaranteed
- Weighing Service
- Specialist processors of Aluminum
- Cash buyers of all grades of ferrous and non-ferrous metals
- Environmentally friendly company
- All waste products handled are fully recycled
- Exotic and precious metal traders
- Works and site clearances undertaken
- Drums, pallets, containers and skips supplied for your metal wastes
- Bailing, Sorting, Segregating, Refining, Granulating and Shearing Facilities

MSB SCRAP METAL currently deals with the below mentioned non-ferrous metals:

- Copper
- Aluminum
- Brass
- Stainless Steel
- Cables (Outstripped)
- Lead
- Drinking Cans (pure aluminum)
- Iron
- Metallic Equipment & Accessories (Radiators, Carburetors, Electronic Waste, Carton Box, Waste Paper etc)
- Plastic Materials

**MSB SCRAP METAL** would get itself involved in the trading of higher volumes of ferrous-based scrap metal which would yield **MSB SCRAP METAL** higher profit margins due to the relative cheapness of ferrous based scrap metal. Trading in greater volumes of ferrous products would require larger tracts of land area for processing and storage purposes and the Directors are of the opinion that will provide the flexibility towards the achievement of this diversification in their portfolio.

Management Address:

3-1 (1<sup>st</sup> Floor), Jalan Putra Mahkota 7/5B,  
Section 7, Putra Heights,  
47650 Subang Jaya, Selangor.  
Tel: 03-5192 3722  
Fax: 03-5192 2209

Associate Company:

Vision Waste Disposal Sdn Bhd  
3-1 (1<sup>st</sup> Floor), Jalan Putra Mahkota 7/5B,  
Section 7, Putra Heights, 47650 Subang Jaya.  
Tel: 03-5192 3722/ 019-320 845  
Fax: 03-5192 220



*“We care for your environment”*  
**REDUCE, RECYCLE, REUSE**





VISION WASTE DISPOSAL SDN BHD

---

# GENERAL NOTES & ATTACHMENT



*“We care for your environment”*  
*REDUCE, RECYCLE, REUSE*



## **GENERAL NOTES**

### **1. INSURANCE COVERAGE**

We provide the following insurance coverage.

- a) Public liability insurance RM 1,000,000.00 (1 million) unlimited (AOP)
- b) Insurance policy for workmen 's compensation  
(Multi level (group) insurance for valued employees)
- c) Socso
- d) EPF

### **2. SECURITY**

All employees / operative deployed at site will be provided with uniforms, safety helmets and safety shoes.

### **3. VALIDITY OF QUOTATION**

Any quotation will remain for acceptance within 90 days from the date of quotation after which we reserve the right to reserve our price.

### **4. TERMS OF PAYMENT**

Thirty (30) days upon the date of invoice.

### **5. SUPERVISION**

Our project Manager / Operation executive will be constantly checking on our operatives deployed and their work done. They will also check and liase with the owner or their representative on any matters regarding rubbish disposal and other works.

### **6. NOTICE**

Preferably three months in advance notice.

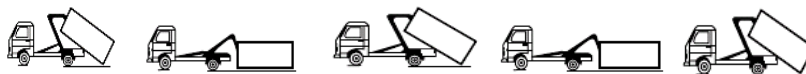

*“We care for your environment”*  
**REDUCE, RECYCLE, REUSE**



Overseas Assurance Corporation (Malaysia) Berhad (102249-P)
(A member of Great Eastern Holdings Limited)
Level 18, Menara Great Eastern, 305, Jalan Ampang, 50450 Kuala Lumpur
General Line : (603) 4259 7888 Fax : (603) 4813 0055
Customer Service Careline : (603) 4259 8900
Website : www.oac.com.my



RENEWAL CERTIFICATE

Account No. : NMKL1608

Policy No. : LPL-L0014247-KL

Insured Name : VISION WASTE DISPOSAL SDN BHD
Postal Address : 3-1 (1ST FLOOR),
JALAN PUTRA MAHKOTA 7/5B,
PUSAT BANDAR PUTRA POINT,
SECTION 7, PUTRA HEIGHTS,
47650 SUBANG JAYA, SELANGOR

Period of Insurance: From 12/05/2015 to 11/05/2016 MIDNIGHT EXPIRY
Any subsequent period for which the Insured shall pay and
the Corporation may agree to accept a renewal premium.

Premium Due : RM 2,500.00
Add GST (6%) : RM 150.00
Stamp Duty : RM 10.00
Total Amount Due : RM 2,660.00

Risk : 1 PUBLIC LIABILITY

Insured's Trade/Business : WASTE DISPOSAL/GENERAL WORKS/CLEANING SERVICES

Premises : WITHIN MALAYSIA

Indemnity : The Corporation will indemnify the Insured against :

A. All sums which the Insured shall become legally liable to pay
for compensation in respect of :

- 1) accidental bodily injury to third Party
2) accidental loss or damage to property belonging to third party

caused on or about the abovementioned Premises by the fault or
negligence of the Insured or of any person in the Insured's
service whilst engaged in the Insured's Trade or Business as
above described or by any defect in the buildings, ways, works,
machinery or plant of the Insured connected with the Trade or
Business of the Insured at the aforesaid Premises.

B. All costs and expenses of litigation recovered from the Insured
by any claimant or claimants.

VISION WASTE DISPOSAL SDN. BHD.
(749918-X)
3-1 (1st Floor), Jalan Putra Mahkota 7/5B,
Pusat Bandar Putra Point, Section 7,
Putra Heights, 47650 Subang Jaya, Selangor.
Tel : 03-5192 3722 / 4450 / 8973 / 3314
Fax: 03-5192 2209 H/P: 019-320 8450
E-mail: mail@visionwaste.com.my

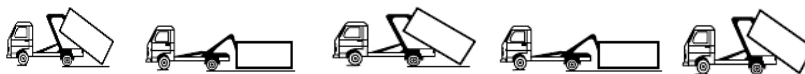

"We care for your environment"
REDUCE, RECYCLE, REUSE



VISION WASTE DISPOSAL SDN BHD

---

# PRODUCT MANUFACTURE



*“We care for your environment”*  
*REDUCE, RECYCLE, REUSE*



## RECYCLE BIN SERIES



Recycle 50 litre (cylinder)

Recycle 50 litre

Recycle 120 litre

Model	Dimension
Recycle 50 litre (cylinder)	815mm(H) x 375mm(D)
Recycle 50 litre	780mm(H) x 380mm(W) x 375mm(L)
Recycle 120 litre	980mm(H) x 510mm(W) x 505mm(L)



*“We care for your environment”*  
**REDUCE, RECYCLE, REUSE**



# RECYCLE BIN SERIES

Kitar Semula Fikir Dulu Sebelum Buang  
**GO GREEN**

Recycling save energy, reduce waste and pollution. Recycling improves cleanliness and quality of life.

Kaca  
Glass



Kertas  
Paper



Tin Aluminium / Plastik  
Aluminium Cans / Plastic



Stainless Steel Top  
Recycle Bin

Model	Dimension
Stainless Steel Top	790mm(H) x 400mm(D)
Recycle Bin	
Recycle 240 litre (with wheels)	930mm(H)-A x 550mm(W)-B x 490mm(L)-C

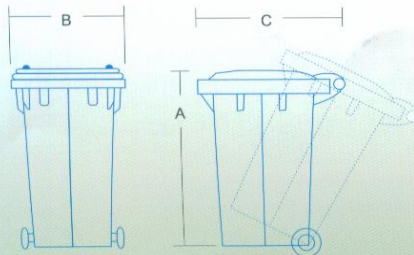

Recycle 240 litre

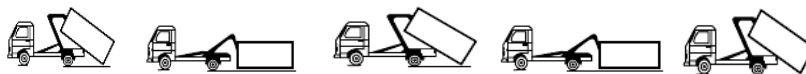

*“We care for your environment”*  
**REDUCE, RECYCLE, REUSE**



**VISION WASTE DISPOSAL SDN. BHD.** (749918-X)  
 Waste Disposal - MBSA & DBKL Registered Contractor  
 No. 11-1 (1st Floor), Jalan Putra Mahkota 7/6C, Section 7,  
 Putra Heights, 47650 Subang Jaya, Selangor Darul Ehsan, Malaysia.  
 Tel: 03-5192 3722 Fax: 03-5192 2209 H/P: 019-320 8450  
 Website: [www.visionwaste.com.my](http://www.visionwaste.com.my)  
 E-mail: [mail@visionwaste.com.my](mailto:mail@visionwaste.com.my)

# BULK SERIES METAL AND PLASTIC



Metal Leach Bin

Model	Dimension
Metal Leach Bin	990mm(H) x 1650mm(W) x 1370mm(L) top x 685mm(L) bottom
WB 660	1180mm(H) x 770mm(W) x 1360mm(L)
WB 240	1080mm(H) x 760mm(W) x 590mm(L)
WB 120	930mm(H) x 550mm(W) x 490mm(L)

WB 660



WB 240



WB 120

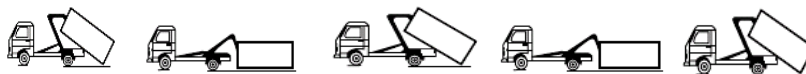
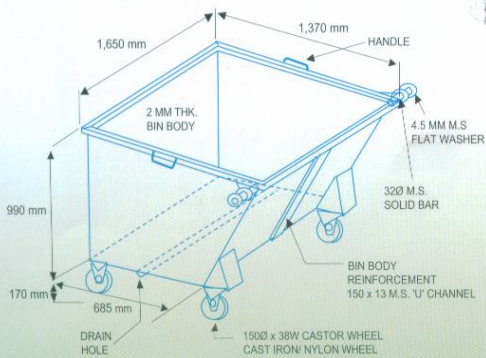

*"We care for your environment"*  
**REDUCE, RECYCLE, REUSE**



## WASTE COMPACTOR



- For users with 50 to 70 cubic meters of waste / week.
- Easy to dump and suitable for supermarkets, departmental stores, hospitals, hotel, large restaurants & light industries.
- Easy to keep clean with no hidden corners; no cake sludge.
- Self – contained; liquid not spilled; loose trash not strewn.



*“We care for your environment”*  
**REDUCE, RECYCLE, REUSE**





## Spiral Waste Packer

Storing & Handling Your Solid Waste



- Refuse storage and screw type discharge Machine which can sanitarly compact & Store a large refuse.
- Stored refuse can automatically discharged and loaded into a refuse collection truck.
- Fully enclosed system and very easy to operate.
- The machine consist of a packer plate and single spiral screw.
- Self washing after every discharge.

## Pick Up Packer



Use primarily in high rise building particularly when garbage are required to be discharged to the mobile garbage truck lorry with compactor tailgate.

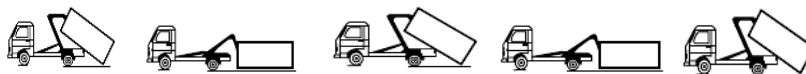

*“We care for your environment”*  
**REDUCE, RECYCLE, REUSE**



# CUSTOMER LIST



*“We care for your environment”*  
*REDUCE, RECYCLE, REUSE*



## LIST OF CUSTOMERS

### *CLIENT LIST FOR CONSTRUCTION COMPANIES*

1. AIMA CONSTRUCTION
2. AL- AMBIA SDN BHD
3. BAXTIUM CONSTRUCTION SDN BHD
4. CASTMET-CYBERJAYA,SUBANG,CHERAS
5. CONLAY CONSTRUCTION SDN BHD
6. FAJAR BARU BUILDERS-MRT(KELANA JAYA,BKT.JALIL,BDR BARU KLANG)
7. MLH BINA SDN BHD
8. MMC GAMUDA- KVMRT
9. MODULAR CONSTRUCTION TECHNOLOGY SDN BHD (MCT)
10. MRCB ENG.SDN BHD (KL SENTRAL)
11. NAKANO CONSTRUCTION SDN BHD
12. P.J.D CONSTRUCTION SDN BHD = 6 PROJECT WITH 30 BINS
13. PEMBINAAN LEOW TUCK CHUI & SONS SDN BHD
14. PEMBINAAN MITRAJAYA SDN BHD
15. PJD LAND SDN BHD
16. PUNCAK DANA SDN BHD
17. S.AKMIDA HOLDING SDN BHD
18. SETIAKON CONSTRUCTION AND BHD
19. SKORBINA SDN BHD
20. SUPERB IMPRESION CREATION
21. SUNWAY CONSTRUCTION SDN BHD
22. TRANSMISSION TECHNOLOGY SDN BHD(KL SENTRAL)
23. WCT CONSTRUCTION BERHAD
24. Y.N.H CONSTRUCTION SDN BHD

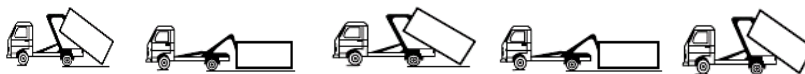

*“We care for your environment”*  
**REDUCE, RECYCLE, REUSE**



## GREEN BUILDING INDEX PROGRAM

### *HOTELS WASTE COLLECTION, RECYCLE PROGRAMME AND USED COOKING OIL COLLECTION*

---

#### **A) SOLID WASTE DISPOSAL – WET & DRY**

---

1. ASCOTT HOTEL, K.L
2. CARLTON HOLIDAY HOTEL, SHAH ALAM
3. CRYSTAL CROWNE HOTEL, KLANG
4. CRYSTAL CROWNE HOTEL, PJ
5. GRAND BLUE WAVE HOTEL, SHAH ALAM
6. GRAND HYATT HOTEL, JALAN PINANG
7. GRAND SEASON, K.L
8. HOTEL SRI PETALING, K.L
9. NOVOTEL HOTEL, K.L
10. PARKROYAL, K.L
11. PICCOLO HOTEL, BUKIT BINTANG
12. PRESCOTT METRO INN HOTEL, KAJANG
13. PULLMAN HOTEL, BANGSAR
14. PULLMAN HOTEL, PUTRAJAYA

#### **B. SUPPLY WASTE COMPACTOR**

---

1. ISTANA HOTEL, K.L
2. ONE WORLD HOTEL, BANDAR UTAMA, DAMANSARA
3. TRADERS HOTEL, K.L

#### **C. CLEARING GREASE TRAP DISPOSAL & BLOCKAGE SERVICES – ON CALL**

---

1. DORSETT GRAND HOTEL, SUBANG JAYA
2. TESCO HYPERMARKET
3. GIANT SUPERMARKET

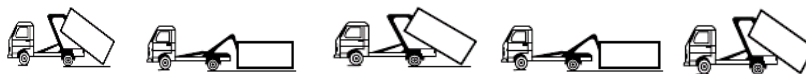

*“We care for your environment”*  
**REDUCE, RECYCLE, REUSE**



***CLIENT LIST FOR FACTORY, MANUFACTURING COMPANIES & BUILDING MANAGEMENT***

1. ANZATEC
2. BARRY CALEBOUT (M) SDN BHD
3. BRIDGESTONE CHEMICAL PRODUCTS (M) SDN BHD
4. BUSCH (M) SDN BHD
5. CAFÉ DECORAL SDN BHD
6. CONFOIL (M) SDN BHD
7. CRYSTAL GLITTER SDN BHD
8. CVS METAL SDN BHD
9. DAISHO FOOD
10. FISHER SCIENTIFIC (M) SDN BHD
11. HACO ASIA PACIFIC SDN BHD
12. HINO MOTOR
13. INSTRIKE SDN BHD
14. JINJANG PAPERS
15. KARA MARKETING (M) SDN BHD
16. KELANA CENTRE POINT
17. MBF PRINTING, PUCHONG AND KOTA KEMUNING
18. MENARA IMC BUILDING, KL
19. MRT
20. NMPH-POS SHAH ALAM
21. NOVABRITE SDN BHD
22. OMYA MALAYSIA SDN.BHD
23. PALM OLEO
24. PYTES BIOTEK
25. QBI PACKAGING
26. QPM
27. SHAH ALAM TYRE & AUTO
28. SIME DARBY MEDICAL CENTRE
29. SM-CYCLO SDN BHD
30. SOCMA TRADING
31. TAT SING
32. YEELEES

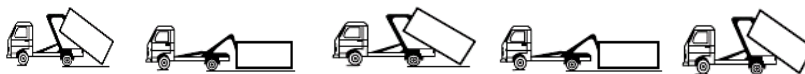

*“We care for your environment”*  
***REDUCE, RECYCLE, REUSE***



SERVICE APARTMENTS

1. IOI BUILDING SERVICES-HIJAUAN CONDO
2. JMB KELANA SQUARE CONDO, P.J
3. JMB MUTIARA UPPER EAST CONDO, AMPANG
4. JMB PARKVIEW CONDO , K.L
5. JMB SOUTH CITY PLAZA, SERI KEMBANGAN
6. JMB SRI PUTRAMAS CONDO 1 & 2
7. JMB SUNSURIA AVENUE CONDO, KOTA DAMANSARA
8. JMB VISTA MUTIARA BLOCK A & C
9. JMB ZEHN CONDO, BUKIT PANTAI
10. MITRALAND-BUGESS RAWSON
11. SERI BUKIT CEYLON
12. SYMPHONY HILL CONDO, CYBERJAYA
13. SYMPHONY HILL CONDO, SUBANG AIRPORT
14. THE FRASER PALACE CONDO, JLN PERAK,K.L
15. THE ZON RESIDENCE,JALAN AMPANG
16. VIPOD SUITES,K.L

RESTAURANT

1. CAFÉ DECORAL SDN BHD



*“We care for your environment”*  
**REDUCE, RECYCLE, REUSE**