

# 5port Pilot Operated Solenoid Valve (SV)

## SV1000 Series (Rc(PT) 1/8)

- 18.0mm Body width
- Transition Flow 700 l/min (5bar)



### How to order

SV11 30-110V-CL-P-01

- ① Solenoid valve
- ② **Function**
  - 1 - 2 position single
  - 2 - 2 position double
  - 3 - 3 position Closed Center
  - 4 - 3 position Exhaust Center
  - 5 - 3 position Pressure Center
- ③ **Coil Rate Voltage**
  - 220V - AC 220V
  - 110V - AC 110V
  - 24V - AC 24V
  - D24V - DC 24V
- ④ **Coil Type**
  - Nil - Without Coil
  - G - Flying Leads (Grommet)
  - C - 3 Pin coil + Connector
  - CL - 3 Pin coil + LED lamp Connector
- ⑤ **Manual Operator**
  - P - Push Button
- ⑥ **Thread Type**
  - Nil - Rc(PT)
  - N - NPT
  - G - G(PF)
- ⑦ **Port Size**
  - 01 - Rc(PT) 1/8

### Symbol

2 Position Single

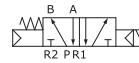

3 Position Closed Center

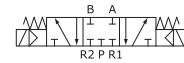

2 Position Double

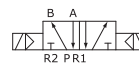

3 Position Exhaust Center



3 Position Pressure Center



### Specification

Function	5port 2position	5port 3position
Fluid	Compressed air	
Ambient and Media temp.	5~60℃	
Max. operating pressure	1.5~10bar	2~10bar
Eff. Sectional Area(5bar)	12.6mm <sup>2</sup>	9.0mm <sup>2</sup>
Response time(5bar)	25ms or less	35ms or less
Max. operating frequency	5c/sec	3c/sec
Lubrication	Not required	
Manual override	Push button	
Coil insulation	F-Class or Equivalent	
Allowable voltage	±10% rated voltage	
Power consumption	AC:3.6VA(60Hz) / DC:2.5W	

## DIMENSIONS (mm)

2position / 5port single(Grommet type)

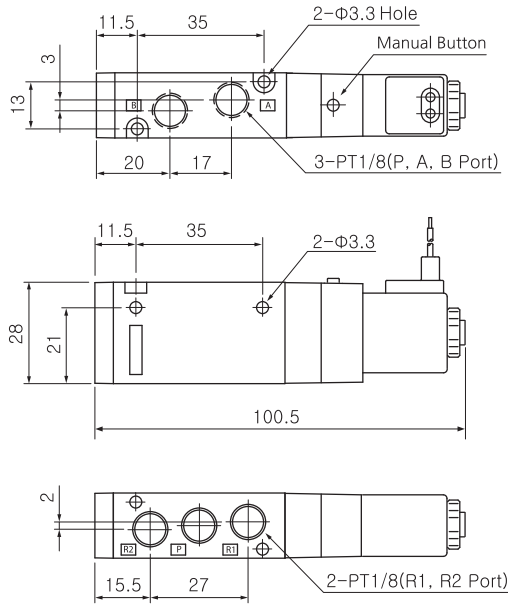

SV1130-□□□V-G-□□□□

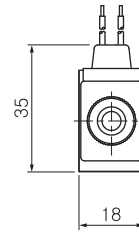
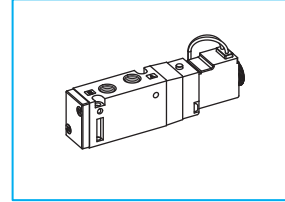

SV1000

SV3000

SV5000

SV6000

SV231  
~232

COIL  
CONNECTOR

SMV100

SMV200

SMVS200

SMVF231  
~232

SMVF250

SMVF350

2position / 5port single(Connector type)

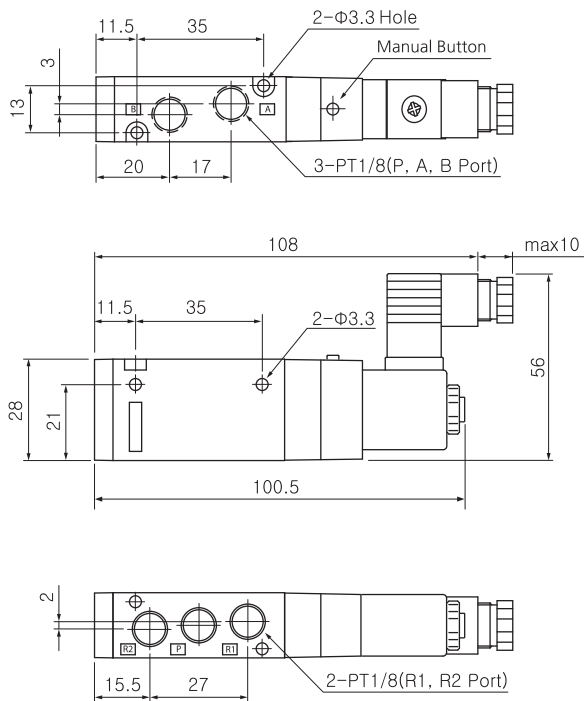

SV1130-□□□V-C-□□□□

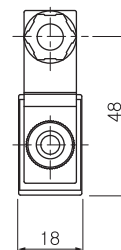
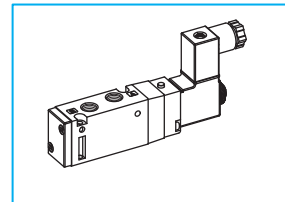

SFVM

SHV

CAUTION

# Series SV1000

## DIMENSIONS (mm)

2position / 5port double(Grommet type)

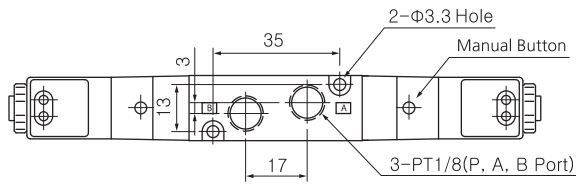

SV1230-□□□V-G-...

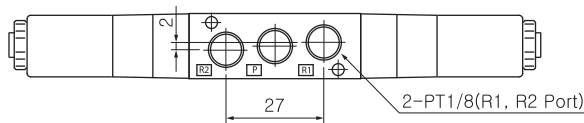
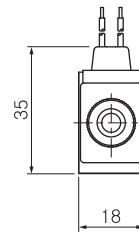
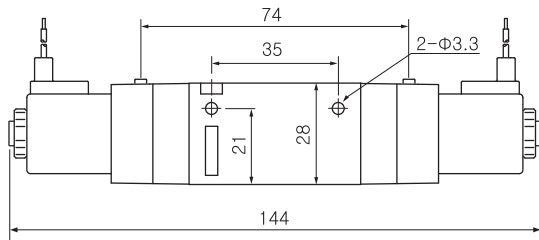
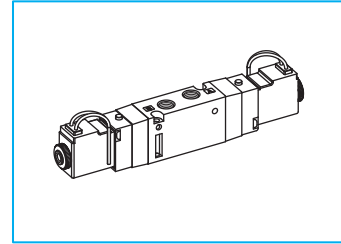

2position / 5port double(Connector type)

SV1230-□□□V-C-□-...

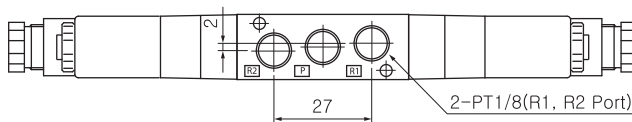
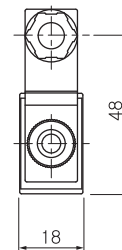
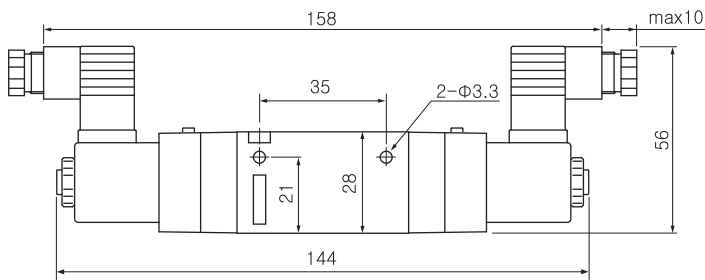
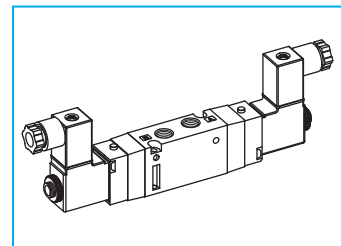
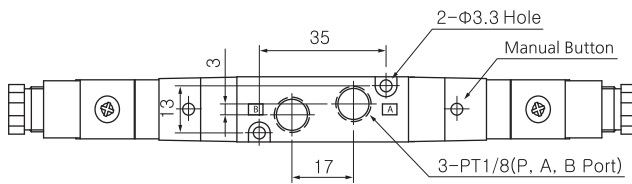

## DIMENSIONS (mm)

3position / 5port double (Grommet type)

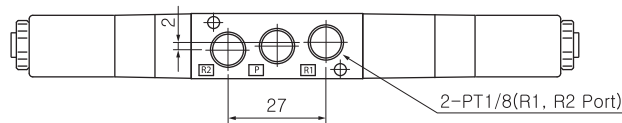
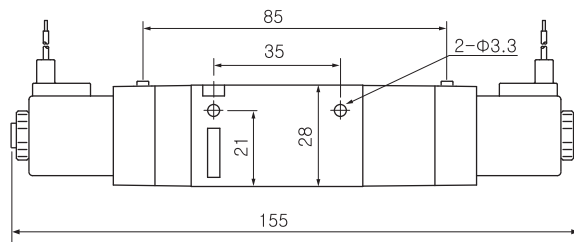
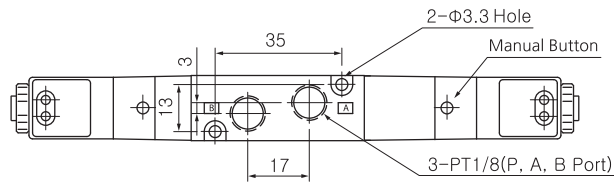

SV1330-□□□V-G-...

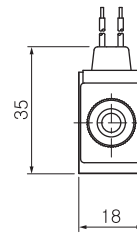
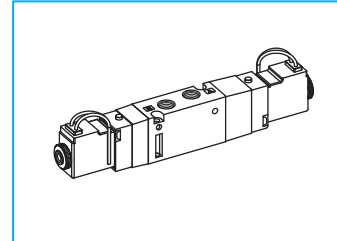

3position / 5port double (Connector type)

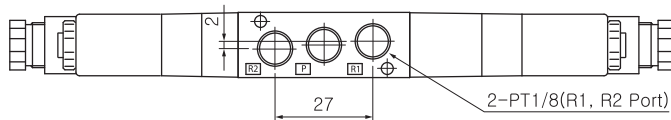
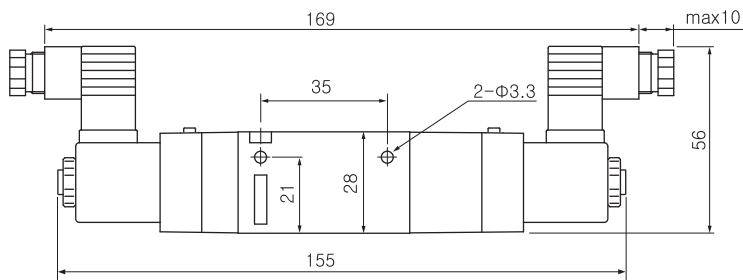
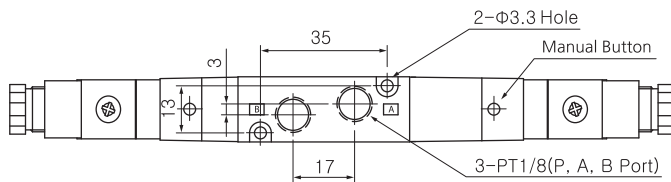

SV1330-□□□V-C□-...

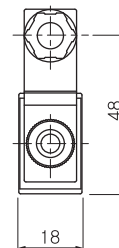
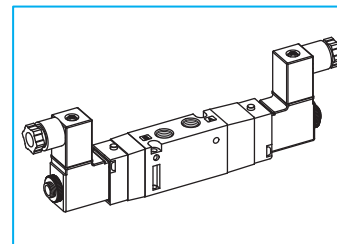

- SV1000
- SV3000
- SV5000
- SV6000
- SV231 ~232
- COIL CONNECTOR
- SMV100
- SMV200
- SMVS200
- SMVF231 ~232
- SMVF250
- SMVF350
- SFVM
- SHV
- CAUTION