

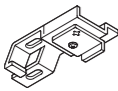









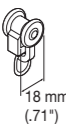

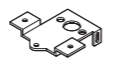

Powerful + Supertrac Parts (For Curve)

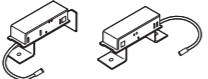
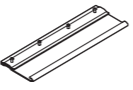
Product Name	Product Code	Product Name	Product Code	Product Name	Product Code
SP Ceiling Single Bracket M2 	00510022	SP Curved Master Roller M Right  73 mm (2.9") 81 mm (3.2")	00510166	SP Curved Guide Roller 	00510170
SP Roller  18 mm (.71")	00240011	SP Curved Master Roller M Left  81 mm (3.2") 73 mm (2.9")	00510167	SP Curved Installation Aids  (for Pulley Set) (for Adjuster)	00510171
SP OM Roller  18 mm (.71")	00240010	SP Curved Pilot Roller Right  66 mm (2.6")	00510168	Powerful Attachment No. 1 	00510061
SP Swing Roller with Ring 	00240059	SP Curved Limit Switch A (for ceiling attachment) 	00510330	SP OT Splice 	00240003
SP End Stop 	00240020	SP Limit Switch A 	00510303	Wire ø1.5 	00510072
SP Pulley Set (wire) 	00510047	Two-way draw: 10 m (394") or less One-way draw: 5 m (197") or less Rail overlap (500 mm/20"): 9.5 m (374") or less	00510303	SP Cord Clip 	00510029
SP One-way Adjuster 	00240036	SP Limit Switch B 	00510304		
		Two-way draw: 10 m (394") to 20 m (787") One-way draw: 5 m (197") to 10 m (394") Rail overlap (500 mm/20"): 9.5 m (374") to 19.5 m (768")	00510304		

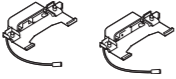
Powerful + Supertrac Parts (For Arch, Skylight and Slope Skylight)

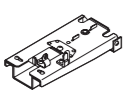
Please inquire of TOSO about arch, skylight and slope skylight.

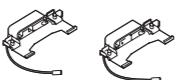
Motorized Curtain Track

Powerful + Supertrac



- Motorized curtain rail suitable for medium weight draperies.
- Available for straight, curve, arch, skylight and slope windows.

Powerful + Supertrac's Unique Features

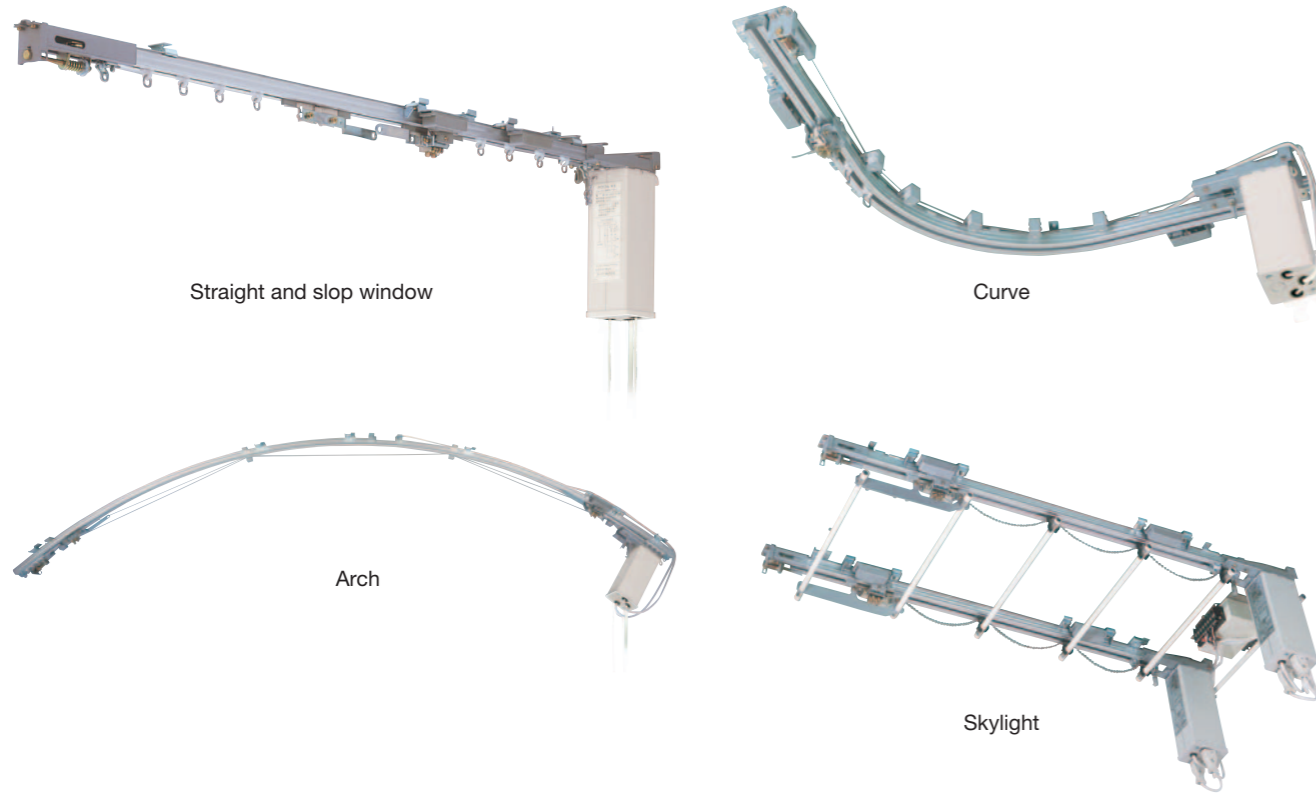

Available for straight, curve, arch, skylight and slope windows.

Exceptionally durable wire used for motor drive transmission.
Passed a 10,000 cycle open-close test.

Ready for draperies up to 20 m (787") long with 80 kg (176 lb) in weight.

Motor Specifications

Item		Powerful 3L Series						Powerful 4P Series					
		Powerful 3L 220 V		Powerful 3L-HM 220 V		Powerful Little N3L 220 V		Powerful 4P 220 V		Powerful 4P-HM 220 V		Powerful 4P-HL 220 V	
Rated power voltage	VAC	220		220		220		220		220		220	
Rated power frequency	Hz	50	60	50	60	50	60	50	60	50	60	50	60
Rated power current	A	0.4	0.35	0.4	0.35	0.25	0.3	0.4	0.35	0.4	0.35	0.4	0.35
Power consumption	W	80	75	80	75	60	70	80	75	80	75	80	75
Operating voltage	VAC	Same as power source		Same as power source		Same as power source		Same as power source		Same as power source		Same as power source	
Operating current	A	Same as power source		Same as power source		Same as power source		Same as power source		Same as power source		Same as power source	
Time rating	min.	5		5		5		5		5		5	
Overheat protection operating temperature	°C	120±10		120±10		120±10		120±10		120±10		120±10	
Internal electric circuit		Built-in Inter rock circuit		Built-in Inter rock circuit		Built-in Inter rock circuit		Auto keep circuit, built-in Inter rock circuit		Auto keep circuit, built-in Inter rock circuit		Auto keep circuit, built-in Inter rock circuit	
Operating switch spec.		Locker switch		Locker switch		Locker switch		3-button momentary contact switch Open: A contact Stop: B contact Close: A contact		3-button momentary contact switch Open: A contact Stop: B contact Close: A contact		3-button momentary contact switch Open: A contact Stop: B contact Close: A contact	
Weight of main unit	kg (lb)	1.8 (4.0)		1.8 (4.0)		1.8 (4.0)		1.8 (4.0)		1.8 (4.0)		1.8 (4.0)	
Operating time	sec./m	5	4	9	7	5	4	5	4	9	7	18	14
Maximum curtain weight	kg (lb)	80 (176)	Sloping		Weight		30 (66)	80 (176)	Sloping		Weight		80 (176)
			0°		80 (176)				0°		80 (176)		
			15°		16 (35)				15°		16 (35)		
			20°		13 (29)				20°		13 (29)		
			30°		10 (22)				30°		10 (22)		
45°		8 (18)		45°		8 (18)							
Maximum rail length	m (in)	20 (787")		10 (394")		20 (787")		20 (787")		10 (394")		10 (394")	

*Maximum curtain weight is for a two-way draw.

Applicable Range

Type of curtain track		Supertrac								
Installation Pattern		Straight	Curve	Slope window						
		<p>(Min. 300 mmR/11.8°R)</p> <p>(Natural: 450 mmR/18°, 800 mmR/32°R ore more) (White: 1500 mmR/59°R ore more)</p>	<p>(Max. sloping: 45°)</p>							
								Wire type		Wire type
Powerful 3L Powerful 4P	Maximum curtain weight	kg (lb)	80 (176)	Single curve	Two curves/ Overall curve half	—				
	Maximum rail length	m (in)	20 (787")	50 (110)	30 (66)	—				
Powerful 3L-HM	Maximum curtain weight	kg (lb)	80 (176)	70 (154)	50 (110)	Sloping angle	15°	20°	30°	45°
	Maximum rail length	m (in)	10 (394")	10 (394")	10 (394")	Weight	16 (35)	13 (29)	10 (22)	8 (18)
Powerful 4P-HM	Maximum curtain weight	kg (lb)	80 (176)	70 (154)	50 (110)	Sloping angle	15°	20°	30°	45°
	Maximum rail length	m (in)	10 (394")	10 (394")	10 (394")	Weight	16 (35)	13 (29)	10 (22)	8 (18)
Powerful 4P-HL	Maximum curtain weight	kg (lb)	80 (176)	70 (154)	50 (110)	—				
	Maximum rail length	m (in)	10 (394")	10 (394")	10 (394")	—				
Powerful Little N3L	Maximum curtain weight	kg (lb)	30 (66)	—	—	—				
	Maximum rail length	m (in)	20 (787")	—	—	—				

*Maximum curtain weight is for a two-way draw. Maximum curtain weight for the slope window is a one-way draw.

Type of curtain track		Supertrac				
Installation Pattern		Skylight	Slope skylight	Arch		
		<p>Max. 3 m (118")</p>	<p>Max. 3 m (118")</p> <p>(Max. sloping: 45°)</p>	<p>(Min. 1600 mmR/63°R)</p> <p>Overall arch (semicircle or less)</p>		
						Wire type
Powerful 3L Powerful 4P	Maximum curtain weight	kg (lb)	—	—	—	
	Maximum rail length	m (in)	—	—	—	
Powerful 3L-HM	Maximum curtain weight	kg (lb)	15 (33)	—	Overall arch	
	Maximum rail length	m (in)	10 (394")	—	10 (22)	
Powerful 4P-HM	Maximum curtain weight	kg (lb)	15 (33)	Sloping angle	45° or less	45°
	Maximum rail length	m (in)	10 (394")	Weight	15 (33)	12 (26)
Powerful 4P-HL	Maximum curtain weight	kg (lb)	—	—	Overall arch	
	Maximum rail length	m (in)	—	—	10 (22)	
Powerful Little N3L	Maximum curtain weight	kg (lb)	—	—	—	
	Maximum rail length	m (in)	—	—	—	

*Maximum curtain weight is for a two-way draw. Maximum curtain weight for the skylight is a one-way draw.

Stack-off Allowance Guide

Type	One-way Draw	Two-way Draw		
		Master Roller	Long Master Roller	Rail Overlap
Straight	$\frac{(\ell - 380 \text{ mm})}{100 \text{ mm}} \times 16 \text{ mm} + 370 \text{ mm}$	$\frac{(\ell - 570 \text{ mm})}{200 \text{ mm}} \times 17 \text{ mm} + 370 \text{ mm}$	$\frac{(\ell - 570 \text{ mm})}{200 \text{ mm}} \times 17 \text{ mm} + 430 \text{ mm}$	$\frac{(\ell - 50 \text{ mm})}{200 \text{ mm}} \times 17 \text{ mm} + 280 \text{ mm}$
	$\frac{(\ell - 15")}{3.9"} \times .63" + 15"$	$\frac{(\ell - 22")}{7.9"} \times .67" + 15"$	$\frac{(\ell - 22")}{7.9"} \times .67" + 17"$	$\frac{(\ell - 2.0")}{7.9"} \times .67" + 11"$
Curve	$\frac{(\ell - 90 \text{ mm})}{100 \text{ mm}} \times 17 \text{ mm} + 160 \text{ mm}$	$\frac{(\ell - 160 \text{ mm})}{200 \text{ mm}} \times 17 \text{ mm} + 160 \text{ mm}$		$\frac{(\ell - 160 \text{ mm})}{200 \text{ mm}} \times 17 \text{ mm} + 80 \text{ mm}$
	$\frac{(\ell - 3.5")}{3.9"} \times .67" + 6.3"$	$\frac{(\ell - 6.3")}{7.9"} \times .67" + 6.3"$		$\frac{(\ell - 6.3")}{7.9"} \times .67" + 3.2"$
Skylight	$\frac{(\ell - 410 \text{ mm})}{100 \text{ mm}} \times 12 \text{ mm} + 410 \text{ mm}$	$\frac{(\ell - 580 \text{ mm})}{200 \text{ mm}} \times 12 \text{ mm} + 410 \text{ mm}$		
	$\frac{(\ell - 16")}{3.9"} \times .47" + 16"$	$\frac{(\ell - 23")}{7.9"} \times .47" + 16"$		
Arch	$\frac{(\ell - 380 \text{ mm})}{100 \text{ mm}} \times 16 \text{ mm} + 370 \text{ mm}$	$\frac{(\ell - 570 \text{ mm})}{200 \text{ mm}} \times 17 \text{ mm} + 370 \text{ mm}$		
	$\frac{(\ell - 15")}{3.9"} \times .63" + 15"$	$\frac{(\ell - 22")}{7.9"} \times .67" + 15"$		

*Number of rollers: 8 pcs per meter. Overlap space for the overlap rail: 500 mm (20"). ℓ: total length. Two-way Draw in the table shows a length of stack-off space for one (half) panel.

Component Parts

Straight: One-way draw

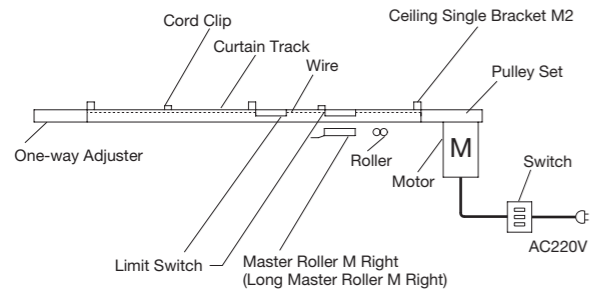

Straight: Two-way draw (Master roller)

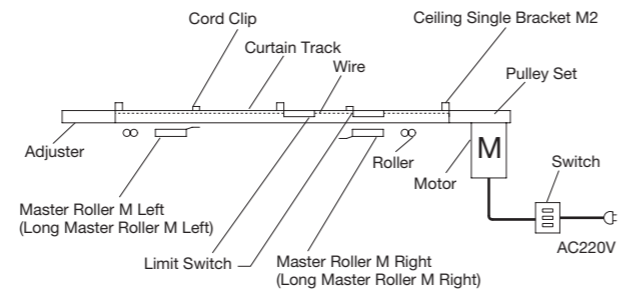

Straight: Rail overlap

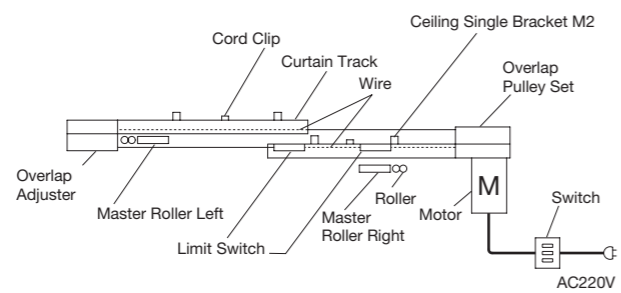

Component Parts

Straight: Two-way draw (Motor recessed in ceiling)

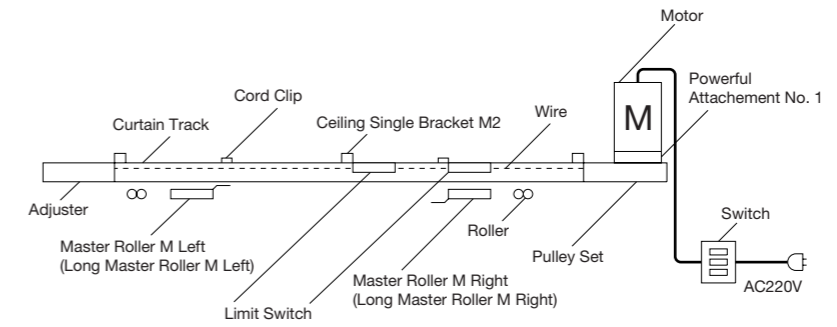

Straight: Hung from pipes (Master roller)

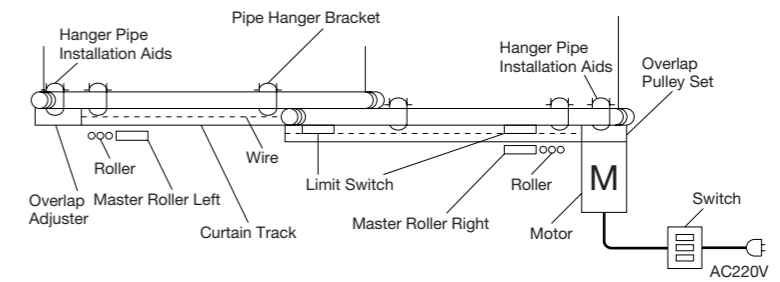

Curve: One-way draw

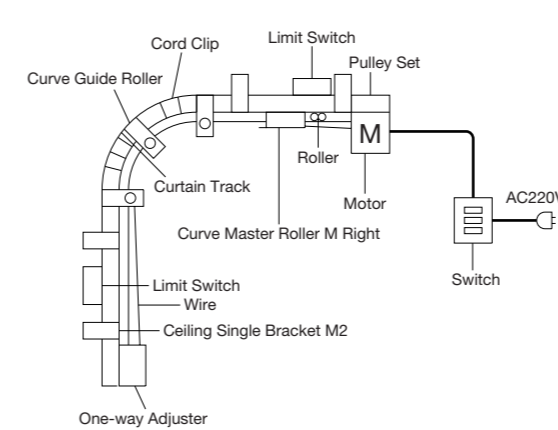

Curve: Two-way draw (Master roller)

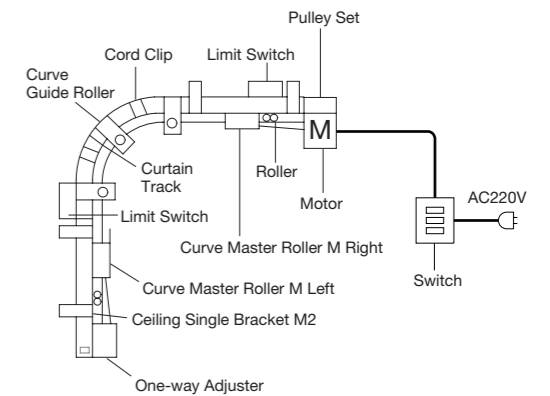

Curve: Rail overlap

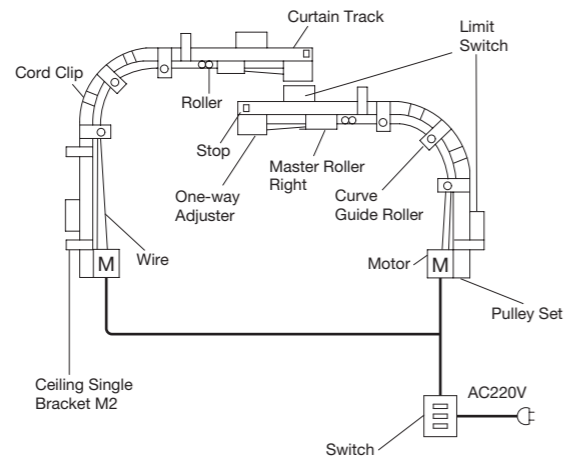

Slope window: One-way draw

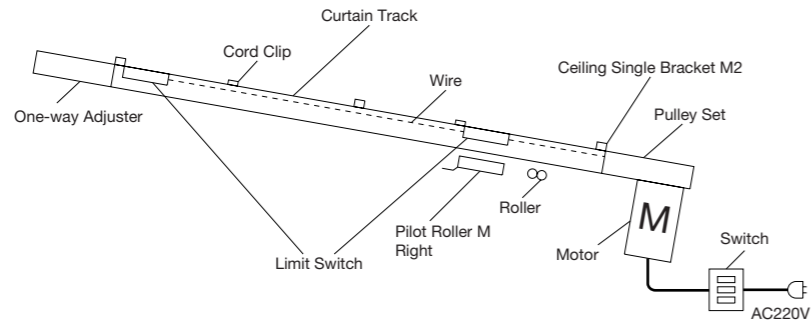

*Notice to the installation positions of the motor so that the curtain hem does not arrive at the floor.

Skylight and Slope skylight: One-way draw

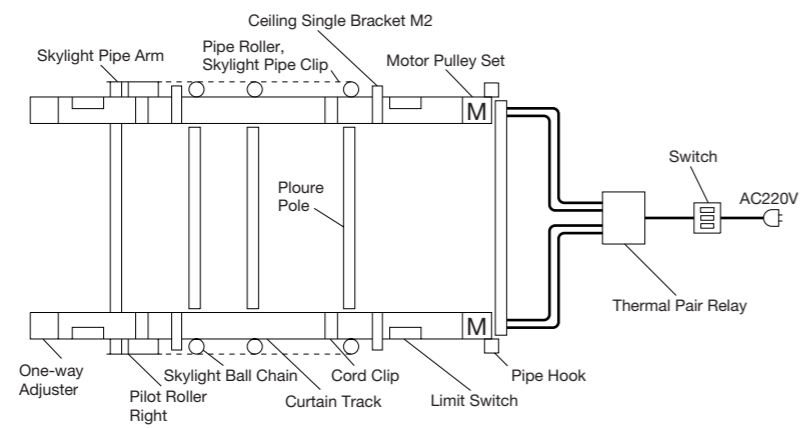

Skylight and Slope skylight: Two-way draw

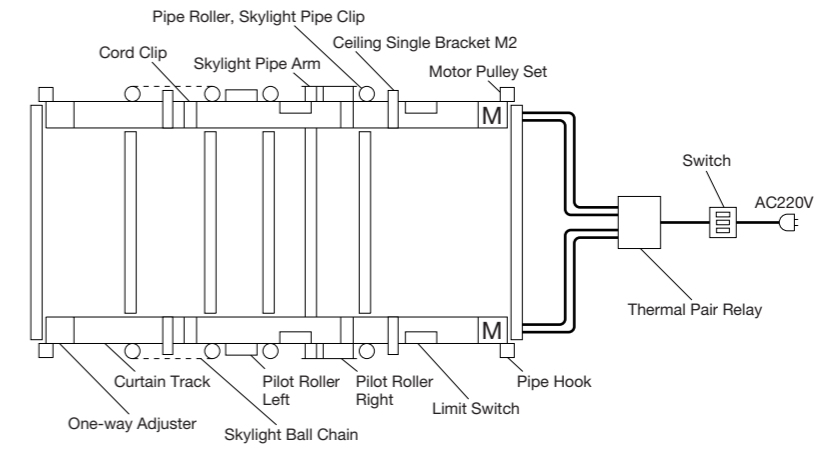

Arch: Two-way draw (Master roller)

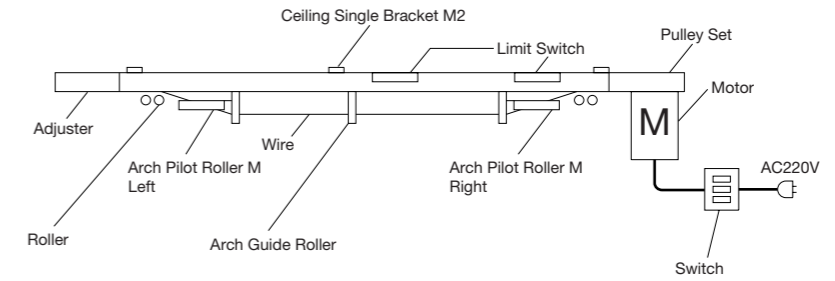

Installation Dimensions and Diagram

Straight: ceiling single attachment
(Master roller)

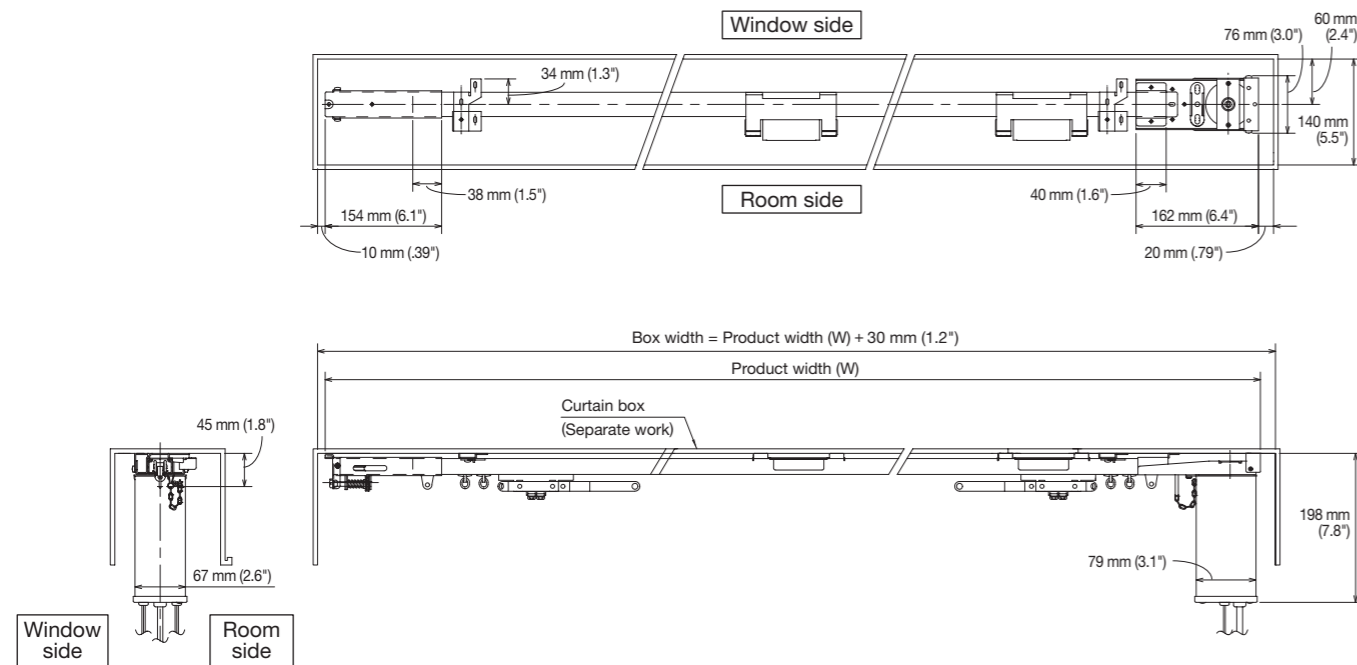

Straight: ceiling double attachment
(Master roller)

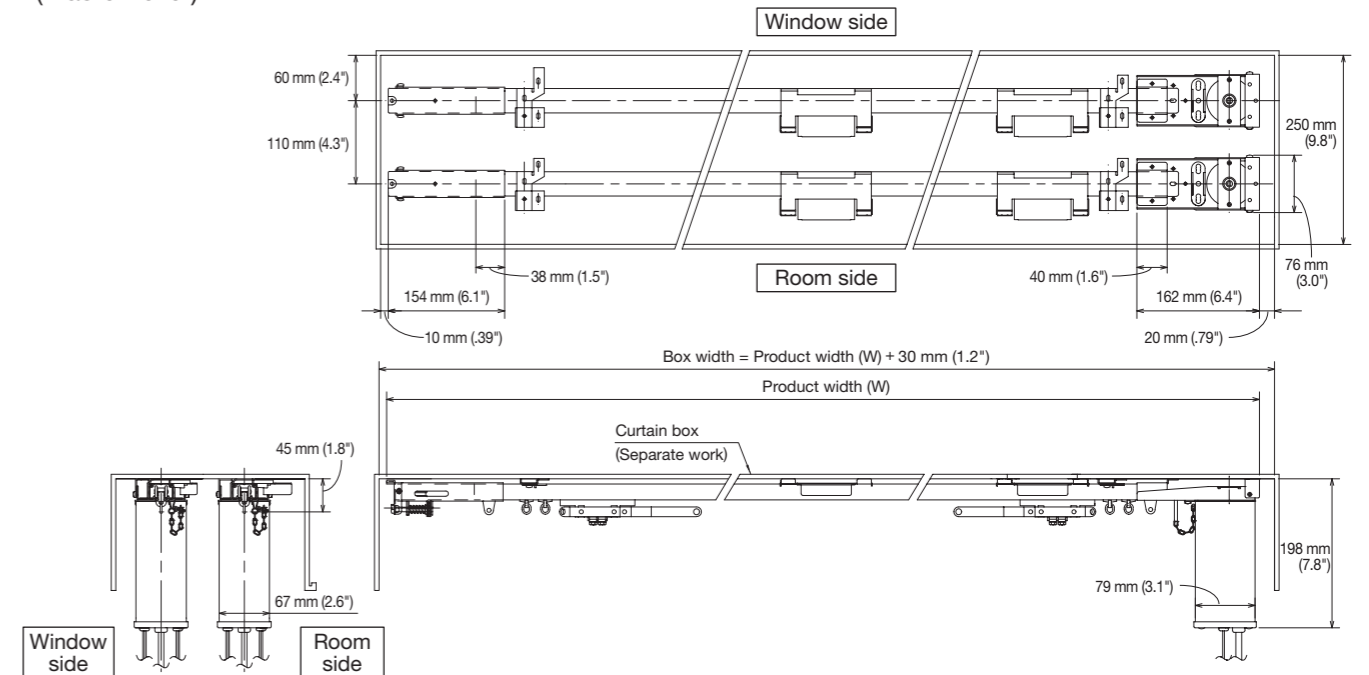

Straight: ceiling single attachment
(Rail overlap)

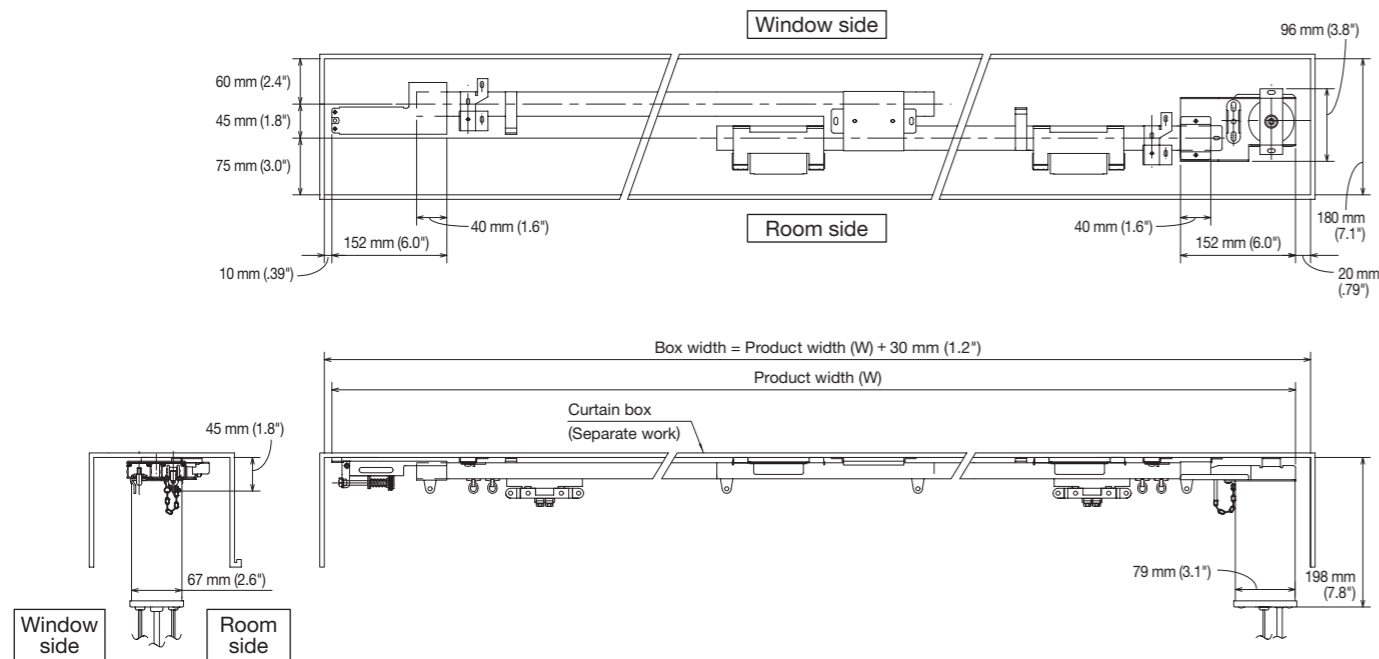

Straight: ceiling double attachment
(Room side: Rail overlap, Window side: Master roller)

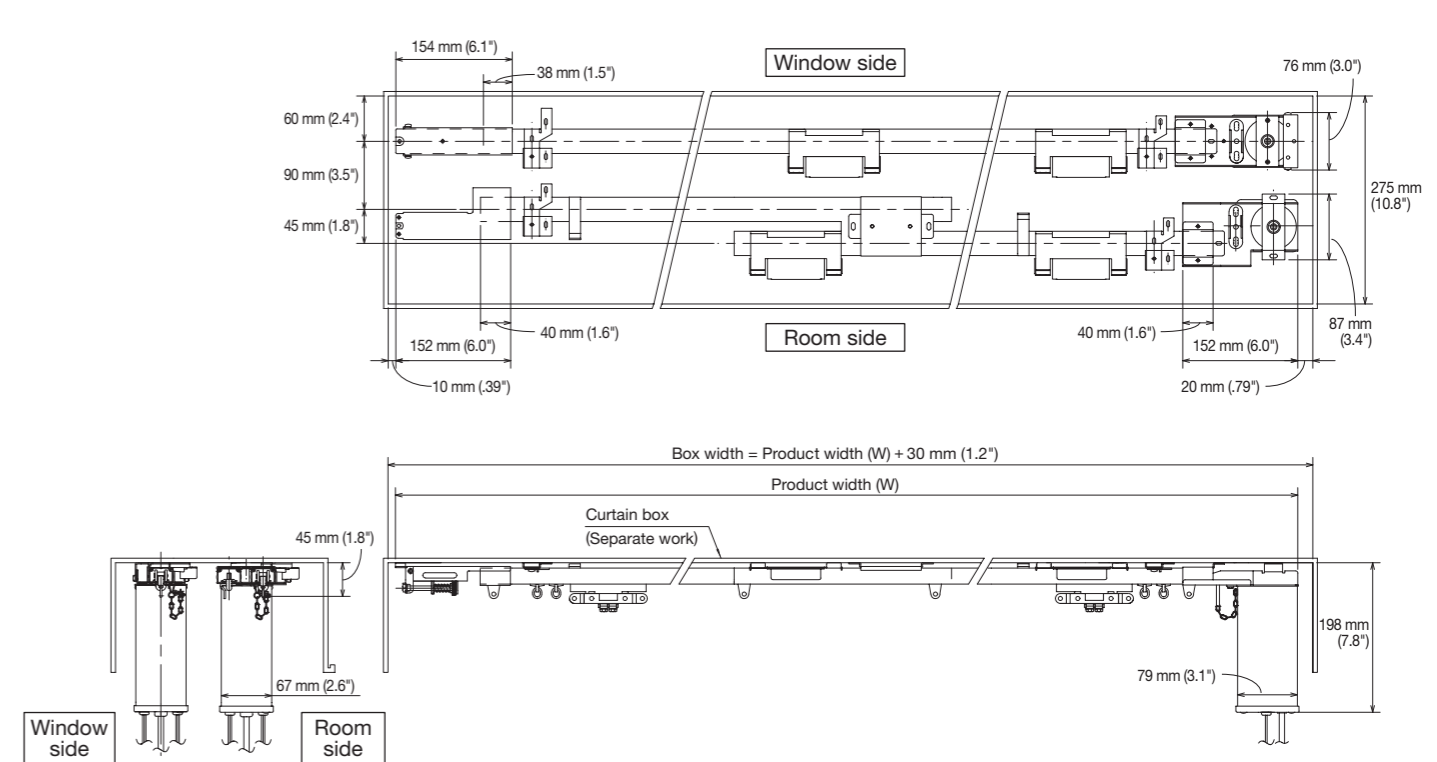

Curve: ceiling single attachment
(Master roller)

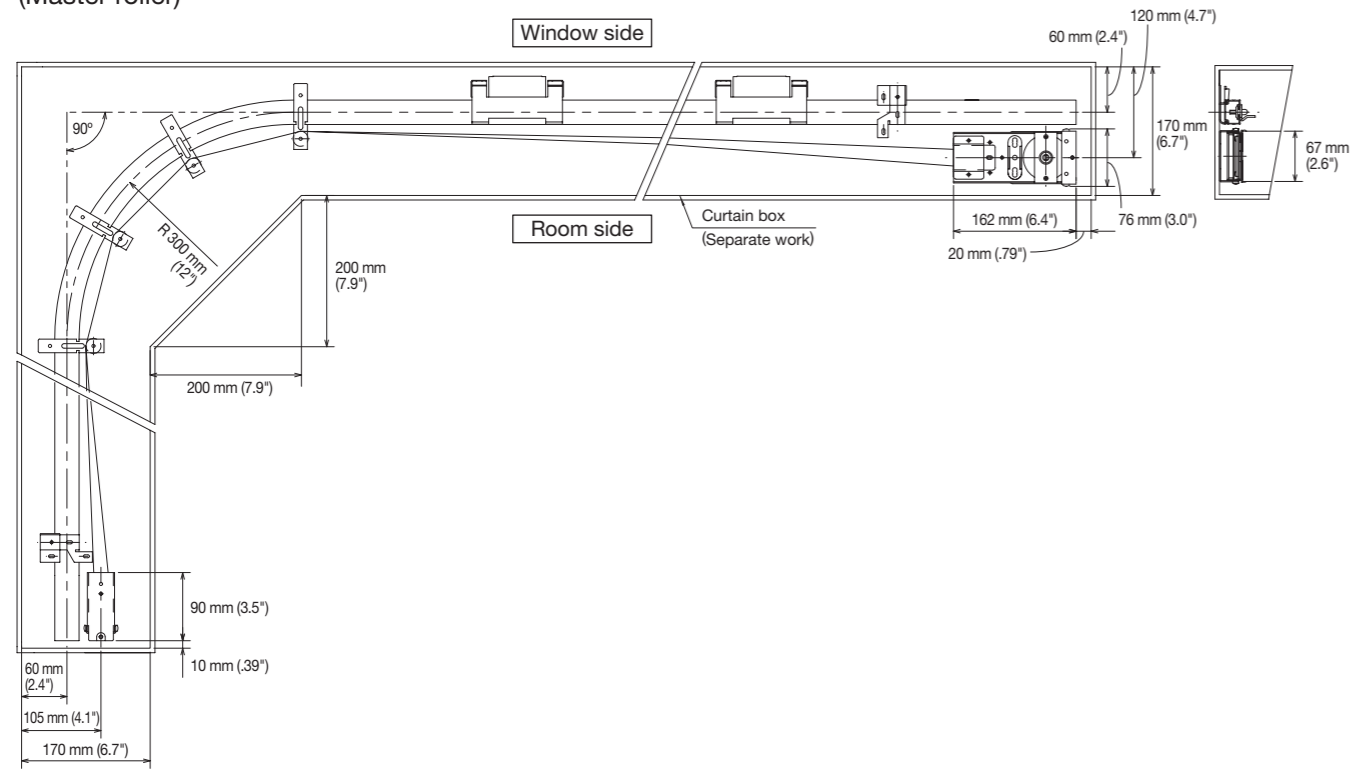

Curve: ceiling single attachment
(Rail overlap)

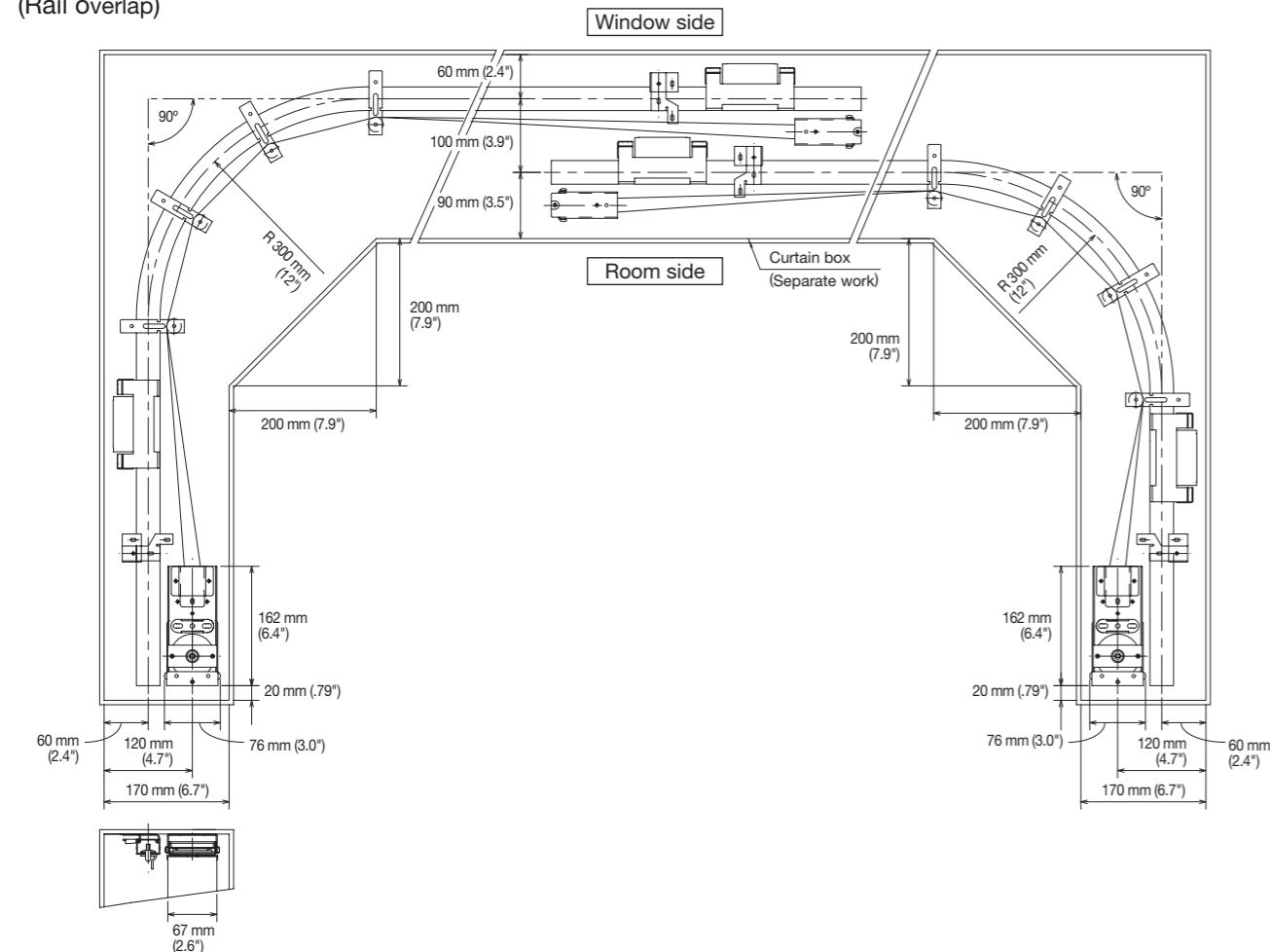

Skylight, Slope skylight: One-way draw

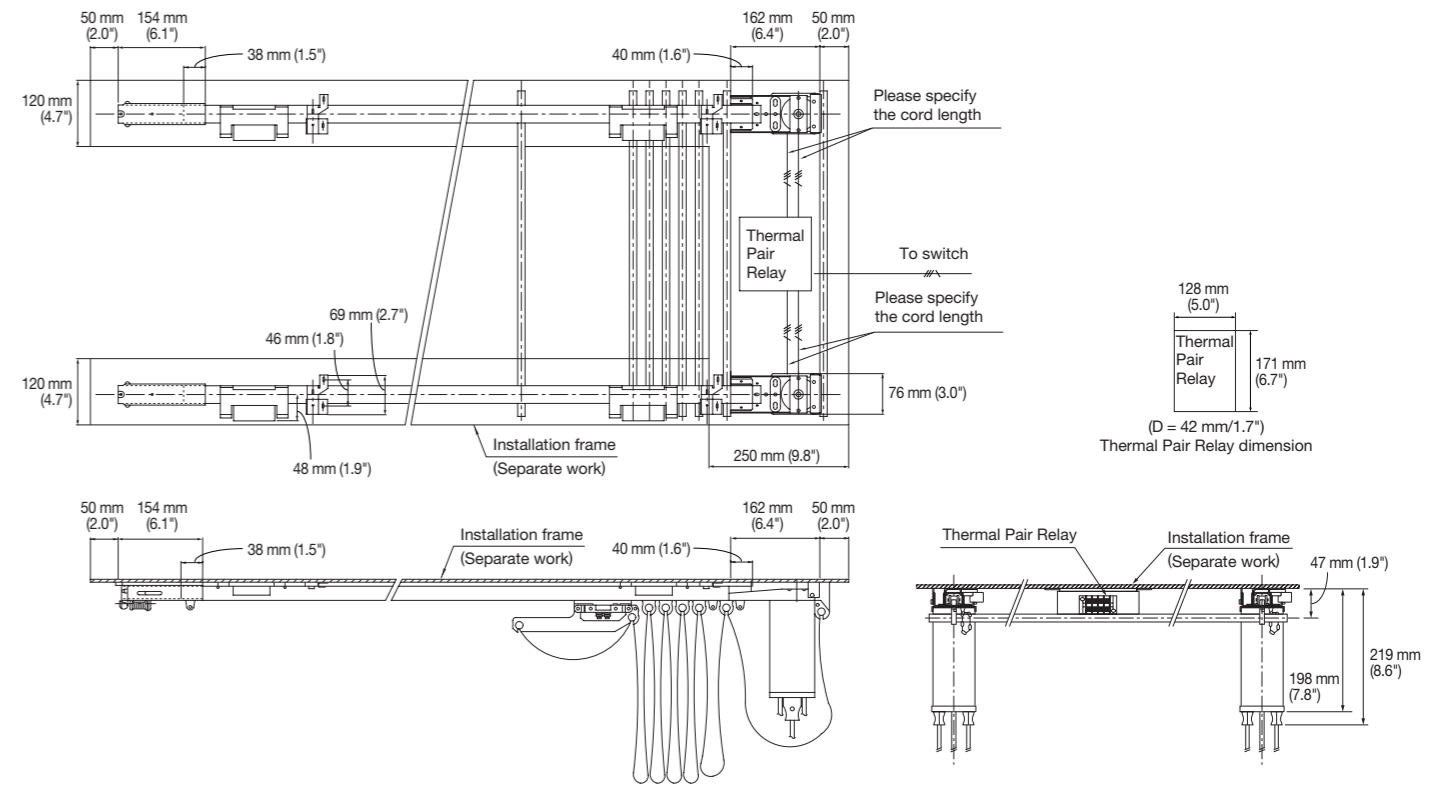

Skylight, Slope skylight: Two-way draw

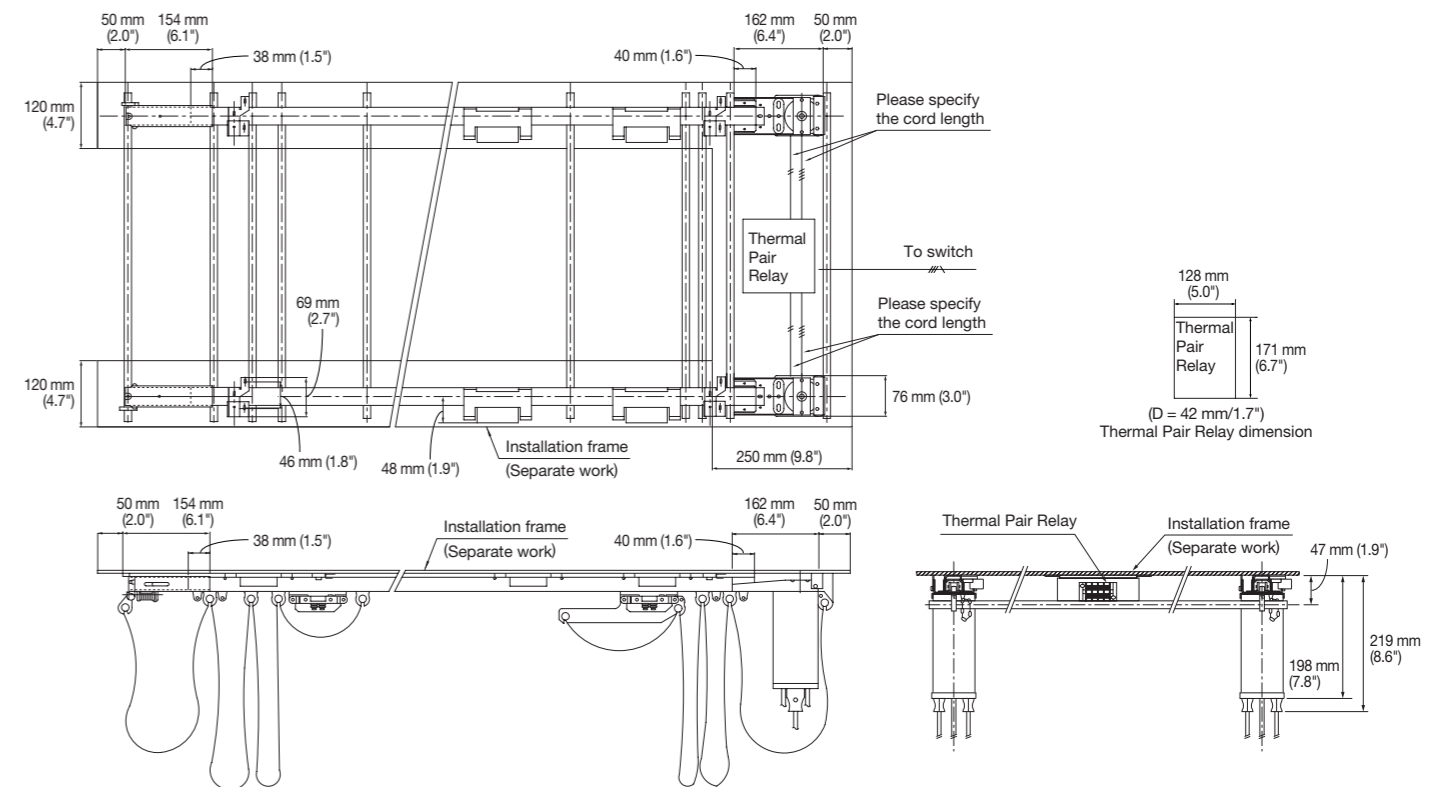

Arch: ceiling attachment
(Master roller)

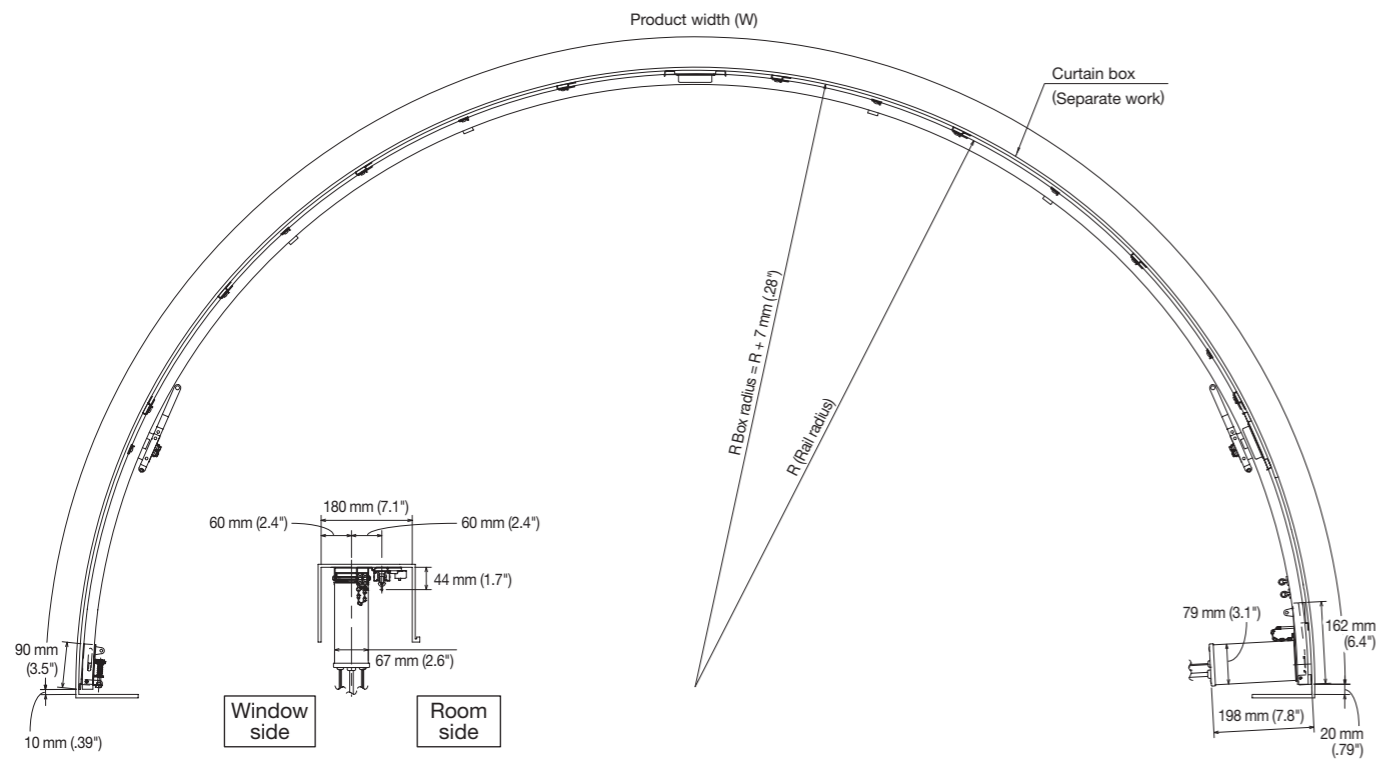

Supertrac Rails

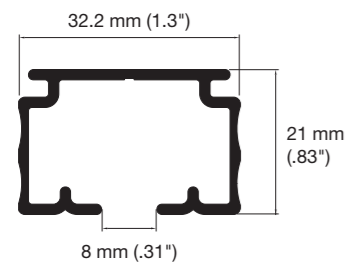

Natural Rails











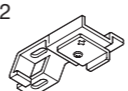

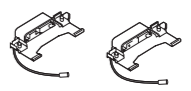
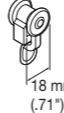

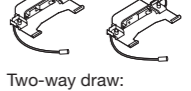

Size	Product Code
3.00 m (118")	00240023
4.00 m (157")	00240026
Curved Rail (500 mmR/20"R) 1.00 m x 1.00 m (39" x 39") (Ordered separately) ^{*1}	00240058

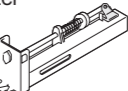
White Rails

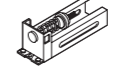
Size	Product Code
3.00 m (118")	00240087
4.00 m (157")	00240088

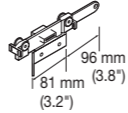
^{*1} Curved 1.00 m x 1.00 m (39" x 39") rails (ordered separately) are 500 mmR (20"R).
Note: Possible radius sizes..... Natural: 450 mmR (18"R), 800 mmR (31") or more

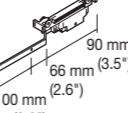
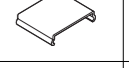
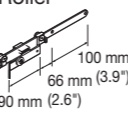
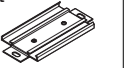
Powerful + Supertrac Parts (For Straight and Slope)

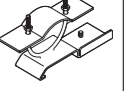
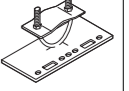
Product Name	Product Code	Product Name	Product Code	Product Name	Product Code
SP Ceiling Single Bracket M2 	Natural 00510022 White 00510319	SP Pilot Roller Right (wire)  ℓ = 125 mm (4.9") 90 mm (3.5")	00510042	SP Limit Switch A 	Natural 00510303
SP Roller 	00240011	SP Pilot Roller Left (wire)  ℓ = 125 mm (4.9") 90 mm (3.5")	00510040	Two-way draw: 10 m (394") or less One-way draw: 5 m (197") or less Rail overlap (500 mm/20"): 9.5 m (374") or less	White 00510317
SP OM Roller 	00240010	SP Pulley Set (wire) 	Natural 00510047 White 00510314	SP Limit Switch B 	Natural 00510304
SP Swing Roller with Ring 	00240059	SP Adjuster 	Natural 00510045 White 00510315	Two-way draw: 10 m (394") to 20 m (787") One-way draw: 5 m (197") to 10 m (394") Rail overlap (500 mm/20"): 9.5 m (374") to 19.5 m (768")	White 00510318
SP Master Roller M Right (wire)  ℓ = 202 mm (8.0")	00510085	SP One-way Adjuster 	Natural 00240036 White 00510316	SP OT Splice 	Natural 00240003 White 00240066
SP Master Roller M Left (wire)  ℓ = 202 mm (8.0")	00510086	SP Overlap Installation Kit M (wire) 	00510024	Wire ø1.5 	00510072
SP Long Master Roller M Right (wire)  ℓ = 272 mm (10.7")	00510038	Pulley Set: 1 Master Roller Right: 1 Master Roller Left: 1		SP Cord Clip 	00510029
SP Long Master Roller M Left (wire)  ℓ = 272 mm (10.7")	00510036	Adjuster: 1 Overlap Bracket: 1 Cord Clip: 10		SP Overlap Bracket 	00240030
		Powerful Attachment No. 1 (available for New Delac) 	00510061	SP Pipe Hanger Bracket for ø 28-43 mm (ø 1.1-1.7") 	00510021
				Hanger Pipe Installation Aids (available Theatrac) for ø 33-50 mm (ø 1.3-2.0") 	00510203

*Please inquire of TOSO about arch, skylight and slope skylight.