



# Push-Buttons and Visual indicators

Catalogue PD0C00018UK02-ev



---

 **WARNING**

FAILURE OR IMPROPER SELECTION OR IMPROPER USE OF THE PRODUCTS AND/OR SYSTEMS DESCRIBED HEREIN OR RELATED ITEMS CAN CAUSE DEATH, PERSONAL INJURY AND PROPERTY DAMAGE.

This document and other information from Parker Hannifin Corporation, its subsidiaries and authorized distributors provide product and/or system options for further investigation by users having technical expertise. It is important that you analyze all aspects of your application and review the information concerning the product or system in the current product catalog. Due to the variety of operating conditions and applications for these products or systems, the user, through its own analysis and testing, is solely responsible for making the final selection of the products and systems and assuring that all performance, safety and warning requirements of the application are met. The products described herein, including without limitation, product features, specifications, designs, availability and pricing, are subject to change by Parker Hannifin Corporation and its subsidiaries at any time without notice.

**SALE CONDITIONS**

The items described in this document are available for sale by Parker Hannifin Corporation, its subsidiaries or its authorized distributors. Any sale contract entered into by Parker will be governed by the provisions stated in Parker's standard terms and conditions of sale (copy available upon request).

**Page****Push button valves Ø 22**

|   |       |
|---|-------|
| Generalities .....                                  | 4     |
| Spring return pushbuttons .....                     | 4     |
| Mushroom head pushbuttons .....                     | 4     |
| Selector switches .....                             | 5     |
| Switch bodies with operating head mounting .....    | 5     |
| Additional switch valves .....                      | 5     |
| Electrical contact blocks .....                     | 5     |
| Mounting block for valves and operating heads ..... | 6     |
| Operating heads .....                               | 6 - 7 |
| Joystick controllers .....                          | 7     |
| Dimensions and assembling .....                     | 8     |

**Visual indicators**

|                                 |    |
|---------------------------------|----|
| Generalities .....              | 9  |
| References and dimensions ..... | 10 |

- Facia mounted operator
- 3/2 NO or NC
- Pneumatic valves combinable with electrical switches
- Modular construction (up to 3 valves per pushbuttons heads)
- Wide range of actuators

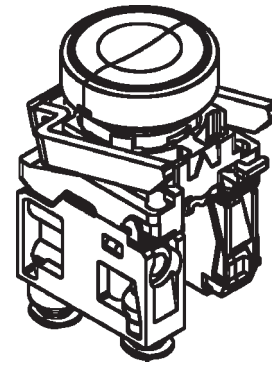

## Operating and additional information

Working pressure

PXB-B3•• 1 to 9 bar  
 PXB-B4•• 1 to 10 bar

Working temperature -15 °C to +60 °C

### Flow

(acc. to ISO 6358)

**PXB-B3••** Q<sub>max</sub>=60 l/min  
 Q<sub>n</sub> = 30 l/min

**PXB-B4••** Q<sub>max</sub>=240 l/min  
 Q<sub>n</sub> = 120 l/min

Connections

Ø4 mm straight Push-in as standard  
 Ø4 mm swivel Push-in on request  
 M5 on request

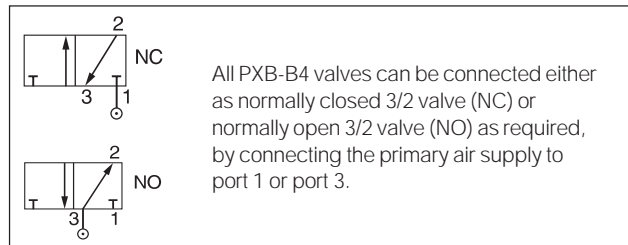







## Spring return pushbuttons - Metal head version - Ø 4 mm straight fittings

| Symbol | Actuator         | Return | Operating force at 6 bar, N | Flow NI/min | Weight kg      | Order code                                 |
|--------|------------------|--------|-----------------------------|-------------|----------------|--|
|        | Pushbutton Black | Spring | 8,5<br>6,0                  | 60<br>240   | 0,077<br>0,082 | <b>PXB-B3111BA2</b><br><b>PXB-B4131BA2</b> |
|        | Pushbutton Green | Spring | 8,5<br>6,0                  | 60<br>240   | 0,077<br>0,082 | <b>PXB-B3111BA3</b><br><b>PXB-B4131BA3</b> |
|        | Pushbutton Red   | Spring | 8,5<br>6,0                  | 60<br>240   | 0,077<br>0,082 | <b>PXB-B3111BA4</b><br><b>PXB-B4131BA4</b> |
|        | Pushbutton Black | Spring | 16,5<br>14,0                | 60<br>240   | 0,087<br>0,092 | <b>PXB-B3251BA2</b><br><b>PXB-B4231BA2</b> |

## Mushroom head pushbuttons - Metal head version - Ø 4 mm straight fittings

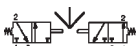

| Symbol | Actuator                       | Return | Operating force at 6 bar, N | Flow NI/min | Weight kg      | Order code                                 |
|--------|--------------------------------|--------|-----------------------------|-------------|----------------|--|
|        | Pushbutton Ø40 mm Black        | Spring | 12<br>6,5                   | 60<br>240   | 0,122<br>0,127 | <b>PXB-B3111BC2</b><br><b>PXB-B4131BC2</b> |
|        | Latching pushbutton Ø40 mm Red |        | 48<br>42,5                  | 60<br>240   | 0,125<br>0,127 | <b>PXB-B3111BT4</b><br><b>PXB-B4131BT4</b> |
|        | Latching pushbutton Ø40 mm Red |        | 49<br>43,5                  | 60<br>240   | 0,125<br>0,127 | <b>PXB-B3121BT4</b><br><b>PXB-B4131BT4</b> |

## Selector switches - Metal head version - Ø 4 mm straight fittings

| Symbol  | Actuator   | Return | Flow<br>Nl/min | Weight<br>kg | Order code          |
|---|--|--------|----------------|--------------|---------------------|
|  | Latching selector button<br>2 positions, Black                         |        | 60             | 0,092        | <b>PXB-B3111BD2</b> |
|   |  |        | 240            | 0,097        | <b>PXB-B4131BD2</b> |
|  | Latching selector button<br>2 positions, Black                         |        | 60             | 0,102        | <b>PXB-B3211BD2</b> |
|   |  |        | 240            | 0,107        | <b>PXB-B4231BD2</b> |
|  | Latching selector button<br>2 positions, Black                         |        | 60             | 0,102        | <b>PXB-B3251BD2</b> |
|   |  |        | 240            | 0,107        | <b>PXB-B4231BD2</b> |
|  | Latching selector button<br>3 positions, Black                         |        | 60             | 0,102        | <b>PXB-B3211BD3</b> |
|   |  |        | 240            | 0,107        | <b>PXB-B4231BD3</b> |
|  | Latching selector button<br>3 positions, Black                         |        | 60             | 0,102        | <b>PXB-B3251BD3</b> |
|   |  |        | 240            | 0,107        | <b>PXB-B4231BD3</b> |
|  | Non latching selector button<br>with long handle<br>3 positions, Black | Spring | 60             | 0,103        | <b>PXB-B3211BJ5</b> |
|   |  |        | 240            | 0,108        | <b>PXB-B4231BJ5</b> |





## Switch bodies with operating metal head mounting - Ø 4 mm straight fittings

For use with ZB4 operating heads



| Symbol  | Actuator | Return | Operating force<br>at 6 bar, N | Flow<br>Nl/min | Weight<br>kg | Order code        |
|---|----------|--------|--------------------------------|----------------|--------------|-------------------|
|  | Plunger  | Spring | 7                              | 60             | 0,048        | <b>PXB-B3111B</b> |
|   |          |        | 4,5                            | 240            | 0,053        | <b>PXB-B4131B</b> |
|  | Plunger  | Spring | 8                              | 60             | 0,048        | <b>PXB-B3121B</b> |
|   |          |        | 4,5                            | 240            | 0,053        | <b>PXB-B4131B</b> |

## Additional switch valves - Ø 4 mm straight fittings

For use with ZB4 and ZB5 operating heads and mounting blocks

| Symbol  | Actuator                       | Return | Operating force<br>at 6 bar, N | Flow<br>Nl/min | Weight<br>kg | Order code       |
|---|--------------------------------|--------|--------------------------------|----------------|--------------|------------------|
|  | Plunger<br>Straight connection | Spring | 7                              | 60             | 0,010        | <b>PXB-B3911</b> |
|   |                                |        | 4,5                            | 240            | 0,015        | <b>PXB-B4931</b> |
|  | Plunger<br>Straight connection | Spring | 8                              | 60             | 0,010        | <b>PXB-B3921</b> |
|   |                                |        | 4,5                            | 240            | 0,015        | <b>PXB-B4931</b> |
|  | Plunger<br>Swivel connection   | Spring | 7                              | 60             | 0,015        | <b>PXB-B3912</b> |
|   |                                |        | 4,5                            | 240            | 0,021        | <b>PXB-B4932</b> |
|  | Plunger<br>Swivel connection   | Spring | 8                              | 60             | 0,015        | <b>PXB-B3922</b> |
|   |                                |        | 4,5                            | 240            | 0,021        | <b>PXB-B4932</b> |

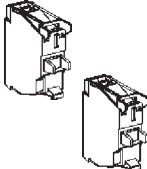
## Electrical contact blocks

| Connections   | Type of contact   | Weight<br>kg | Order code     |
|---|---|--------------|----------------|
|  | Normally open (NO)<br>   | 0,011        | <b>ZBE-101</b> |
|   | Normally closed (NC)<br> | 0,011        | <b>ZBE-102</b> |

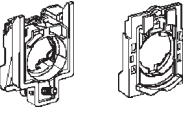

**Mounting block for valves and operating heads**

| Description  | For Metal head ZB4 |                  | For Plastic head ZB5 |                  |
|--|--------------------|------------------|----------------------|------------------|
|  | Weight kg          | Order code       | Weight kg            | Order code       |
|  <p><b>Mounting block for valves and operating heads:</b><br/>to make up a complete push button with one operating head and switch valves.</p> | 0,038              | <b>ZB4-BZ009</b> | 0,006                | <b>ZB5-AZ009</b> |

**Operating heads**

For use with PXB-B3. and PXB-B4. switch bodies

**Spring return pushbuttons**

| Description   | Colour       | Metal head |                | Plastic Head |                |
|---|--------------|------------|----------------|--------------|----------------|
|   |              | Weight kg  | Order code     | Weight kg    | Order code     |
|  <p>Flush</p>         | Black        | 0,029      | <b>ZB4-BA2</b> | 0,018        | <b>ZB5-AA2</b> |
|   | Green        | 0,029      | <b>ZB4-BA3</b> | 0,018        | <b>ZB5-AA3</b> |
|   | Red          | 0,029      | <b>ZB4-BA4</b> | 0,018        | <b>ZB5-AA4</b> |
|   | 6 color caps | 0,029      | <b>ZB4-BA9</b> | 0,018        | <b>ZB5-AA9</b> |
|  <p>Projecting</p>    | Black        | 0,030      | <b>ZB4-BL2</b> | 0,019        | <b>ZB5-AL2</b> |
|   | Green        | 0,030      | <b>ZB4-BL3</b> | 0,019        | <b>ZB5-AL3</b> |
|   | Red          | 0,030      | <b>ZB4-BL4</b> | 0,019        | <b>ZB5-AL4</b> |
|  <p>Flush booted</p> | Black        | 0,034      | <b>ZB4-BP2</b> |              |                |



**Push/push pushbuttons**

| Description   | Colour | Metal head |                 |
|---|--------|------------|-----------------|
|   |        | Weight kg  | Order code      |
|  <p>Flush</p> | Black  | 0,029      | <b>ZB4-BH02</b> |
|   | Green  | 0,029      | <b>ZB4-BH03</b> |
|   | Red    | 0,029      | <b>ZB4-BH04</b> |

**Double headed spring return pushbuttons**

| Description   | Colour Marking | Metal head |                   |
|---|----------------|------------|-------------------|
|   |                | Weight kg  | Order code        |
|  <p>Flush</p> | Green/Red I/O  | 0,047      | <b>ZB4-BA8234</b> |

**Mushroom head pushbuttons**

| Description  | Function                               | Colour | Metal head |                 | Plastic Head |                 |
|--|--|--------|------------|-----------------|--------------|-----------------|
|  |  |        | Weight kg  | Order code      | Weight kg    | Order code      |
|  <p>Ø40 mm<br/>Mushroom head</p> | Spring return                          | Black  | 0,074      | <b>ZB4-BC2</b>  |              |                 |
|  |  | Green  | 0,074      | <b>ZB4-BC3</b>  |              |                 |
|  |  | Red    | 0,074      | <b>ZB4-BC4</b>  |              |                 |
|  | Latching push-pull                     | Red    | 0,077      | <b>ZB4-BT4</b>  |              |                 |
|  <p>Ø60 mm<br/>Mushroom head</p> | Spring return                          | Black  | 0,093      | <b>ZB4-BR2</b>  |              |                 |
|  <p>Ø40 mm<br/>Mushroom head</p> | Latching<br>Turn to release            | Red    | 0,070      | <b>ZB4-BS54</b> | 0,044        | <b>ZB5-AS54</b> |
|  | Latching<br>Release by Ronis key N°455 | Red    | 0,070      | <b>ZB4-BS14</b> |              |                 |

**Selector switches**

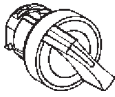
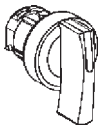
|   | Description            | Function                            | Metal head |                | Plastic Head |                |
|---|------------------------|-------------------------------------|------------|----------------|--------------|----------------|
|   |                        |                                     | Weight kg  | Order code     | Weight kg    | Order code     |
|  | Standard, black handle | 2 positions Stay put                | 0,044      | <b>ZB4-BD2</b> | 0,024        | <b>ZB5-AD2</b> |
|   |                        | 3 positions Stay put                | 0,044      | <b>ZB4-BD3</b> | 0,024        | <b>ZB5-AD3</b> |
|   |                        | 3 spring return to centre           | 0,044      | <b>ZB4-BD5</b> | 0,024        | <b>ZB5-AD5</b> |
|  | Long black handle      | 2 positions Stay put                | 0,045      | <b>ZB4-BJ2</b> |              |                |
|   |                        | 3 positions Stay put                | 0,045      | <b>ZB4-BJ3</b> |              |                |
|   |                        | Spring return to centre             | 0,045      | <b>ZB4-BJ5</b> |              |                |
|   |                        | 1 spring return from left to centre | 0,045      | <b>ZB4-BJ7</b> |              |                |

|  | Description                               | Function             | Key withdrawal | Weight kg | Order code     |
|--|---|----------------------|----------------|-----------|----------------|
|  | <b>Key operated</b><br>(Ronis key N° 455) | 2 stay put positions | Left           | 0,069     | <b>ZB4-BG2</b> |
|  |   |                      | Left and right | 0,069     | <b>ZB4-BG4</b> |

**Tools**

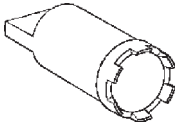
|   | Description        | Weight kg | Order code       |
|---|--------------------|-----------|------------------|
|  | ZB5 head nut tools | 0,160     | <b>ZB5-AZ905</b> |

**PXB-B3**

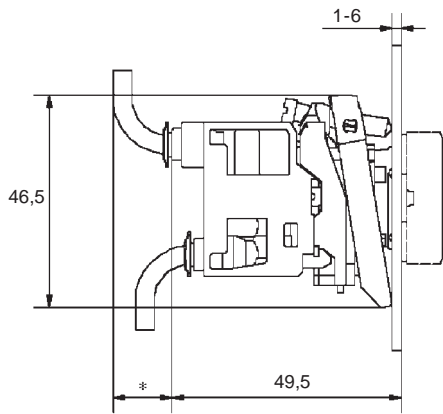

Body width 30 mm  
 \* With 2 x 4 mm tube = 10  
 With 2,7 x 4 mm tube = 15

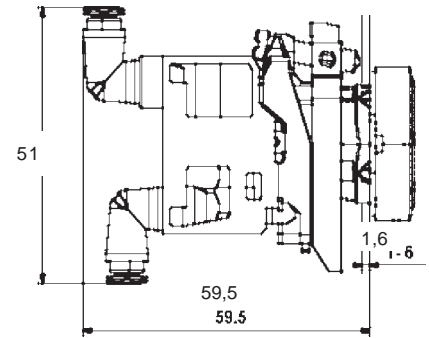
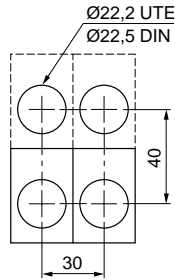

**PXB-B4**

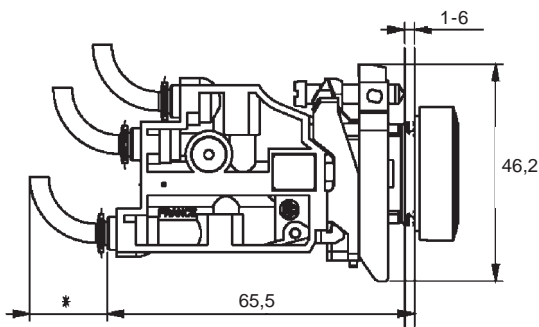

Body width 30 mm  
 \* With 2 x 4 mm tube = 10  
 With 2,7 x 4 mm tube = 15

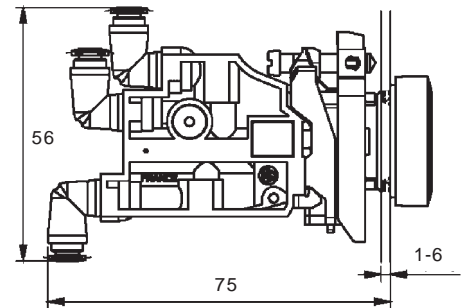

**Assembling of PXB-B3. and PXB-B4. valves on mounting block**

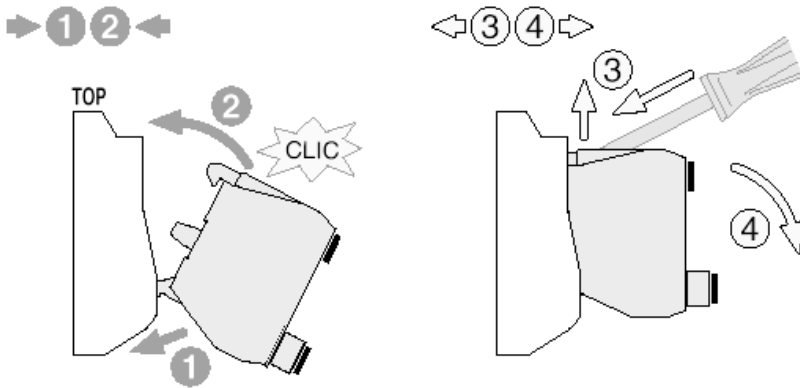

**Assembling of PXB-B3. and PXB-B4. valves on the back of the electrical contact**

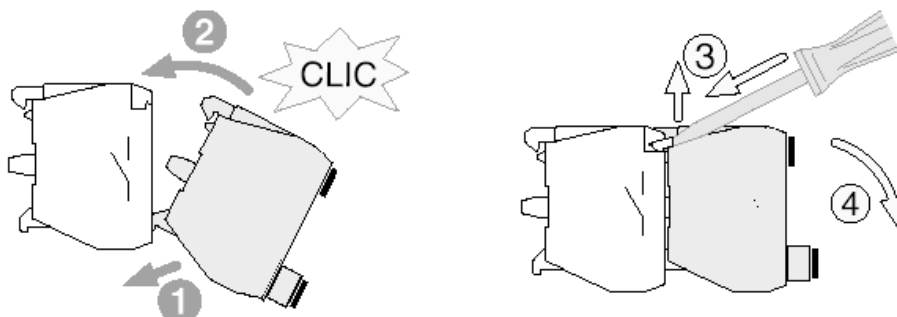



- Lightning fast response
- Simple long life mechanism
- Very high contrast
- All around visibility
- One single pipe connection
- Effective aid to diagnostics

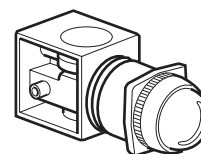

## Operating information

Working pressure 1-8 bar  
 Working temperature -15 °C to +60 °C

## Options and additional information

Connections Ø4 mm straight Push-in  
 as standard

## Order key

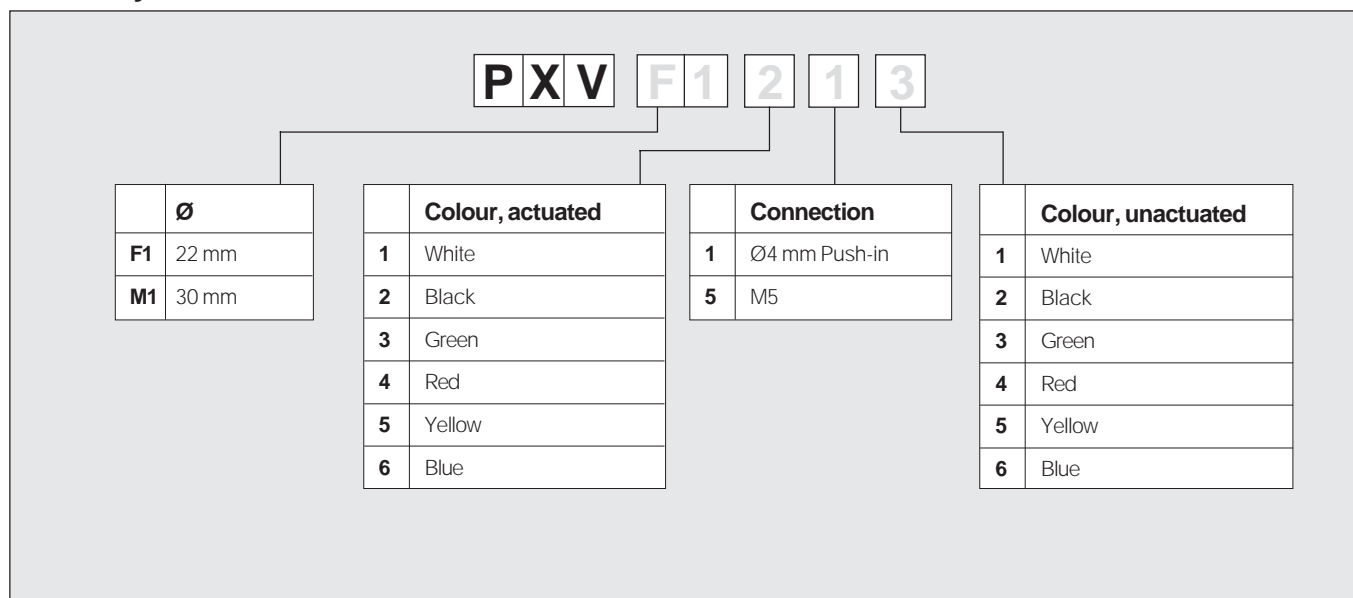

## Ø22 mm Visual Indicators

Black plastic bezel  
In the actuated mode

| Symbol   | Colour * | Weight<br>kg | Order code      |
|--|----------|--------------|-----------------|
|  | Green    | 0,080        | <b>PXV-F131</b> |
|  | Red      | 0,080        | <b>PXV-F141</b> |
|  | Yellow   | 0,080        | <b>PXV-F151</b> |
|  | Blue     | 0,080        | <b>PXV-F161</b> |
|  | White    | 0,080        | <b>PXV-F111</b> |

## Ø22 mm Visual Indicators

Black plastic bezel  
In the unactuated mode

| Symbol   | Colour * | Weight<br>kg | Order code       |
|--|----------|--------------|------------------|
|  | Green    | 0,080        | <b>PXV-F1213</b> |
|  | Red      | 0,080        | <b>PXV-F1214</b> |
|  | Yellow   | 0,080        | <b>PXV-F1215</b> |
|  | Blue     | 0,080        | <b>PXV-F1216</b> |
|  | White    | 0,080        | <b>PXV-F1211</b> |

\* The pneumatic indicators are black in one position and coloured in the other.  
The coloured position corresponds either to the presence of pressure (actuated mode) or the absence of pressure (unactuated mode). For two different colours on the same indicator, please consult Technical Sales Department

### Ø22 mm visual indicators

PXV-F1\*\*

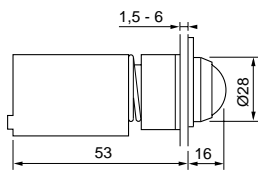

Minimum distance between centres

