

Sun eye[®]

Electronic ROOM THERMOSTAT

*High Technology
for temperature Control*

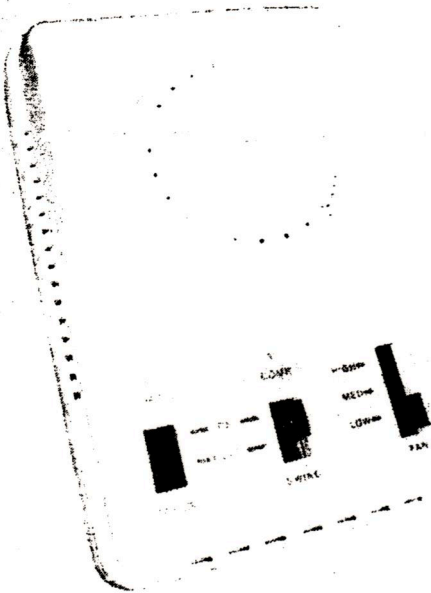

Feature:

1. Power on/off
2. Power/Compressor LED display
3. Speed control H/M/L
4. Temperature setting 16°C-30°C
6. AC220-230V. / 1P / 50-60Hz
7. Swing on/off

Dimension

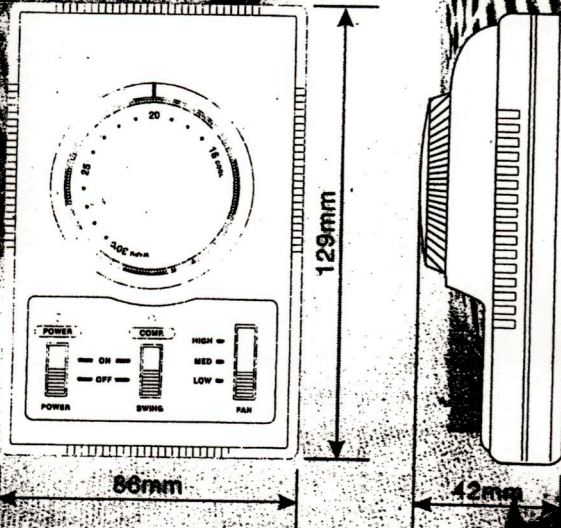

Product Air Cond

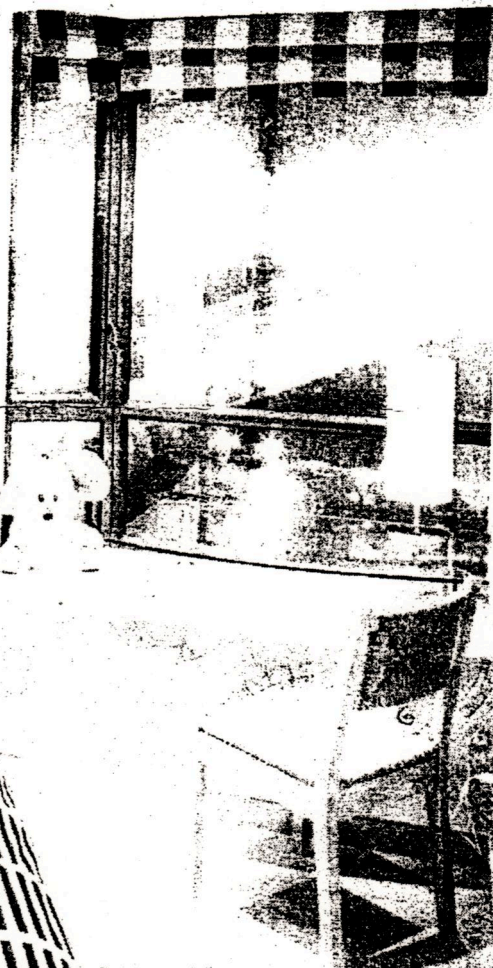

INSTALLATION OF ELECTRONIC ROOM THERMOSTAT

Information:

- Be caution while installation.
- Check Electrical wiring of the Air conditioner before installation.
- Location to install the room thermostat must not wet.
- While installation must not let any particle such as small copper wire or piece of metal drop inside the room thermostat.
- After installation should not touch a device room thermostat.

Hint:

-For better performance of the device room thermostat should be install in a proper location as shown.

Floor Type

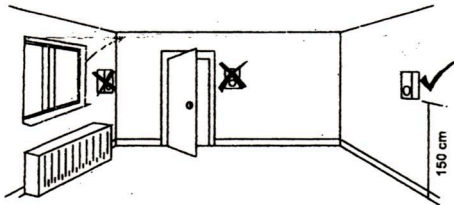

Ceiling Type

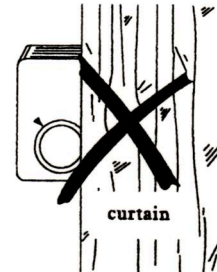
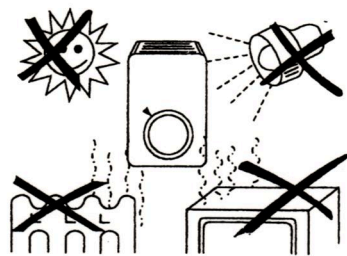
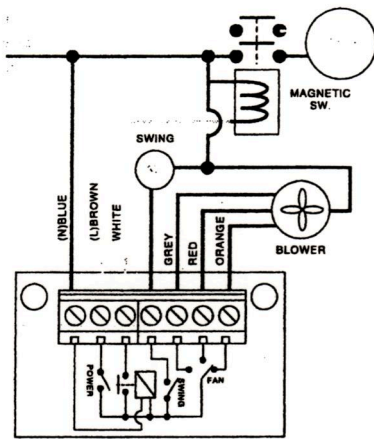
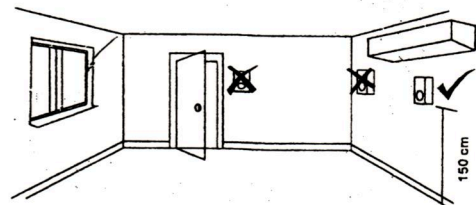

Operating power supply
Fan control current
Magnetic control current
Motor swing current
Compressor delay time

220V (± 10%) , 50/60Hz.
3 Amp.(Max).
1 Amp.(Max).
1 Amp.(Max).
3 minutes. ± 20 second

WIRING DIAGRAM PICTURE

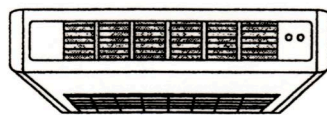

Indoor unit

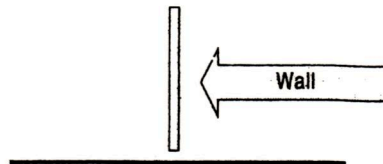

Outdoor unit

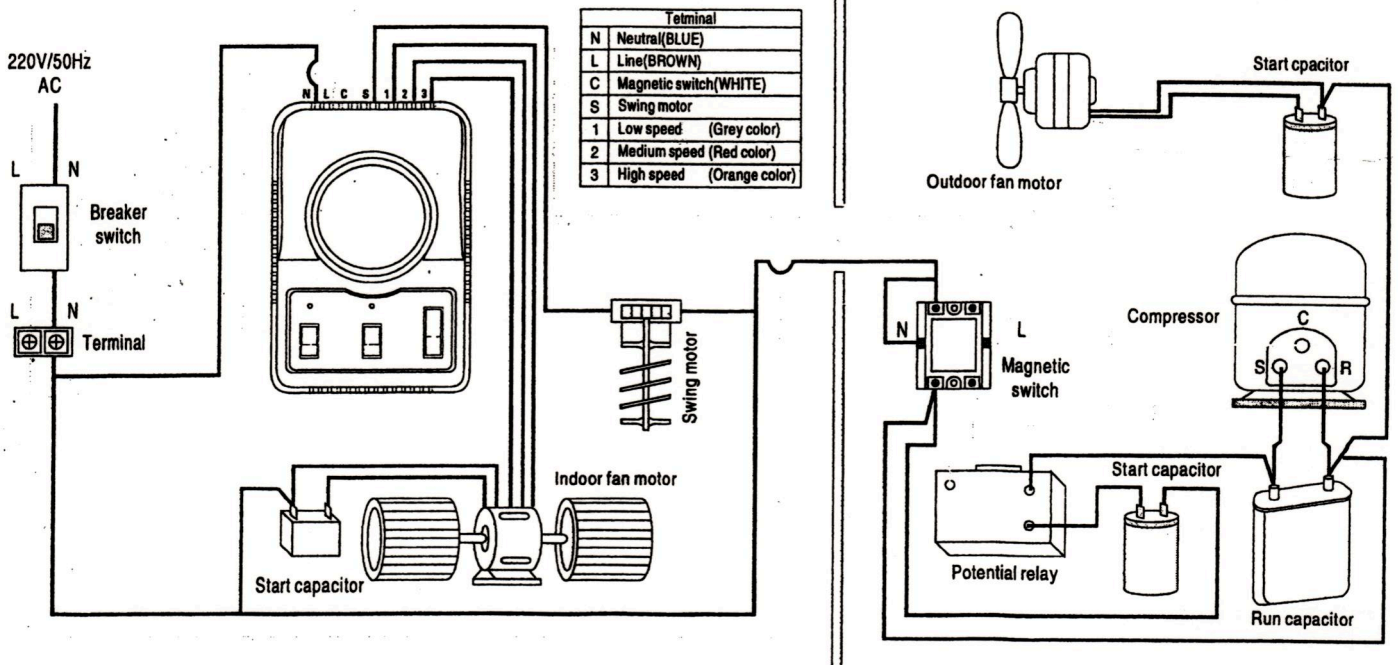

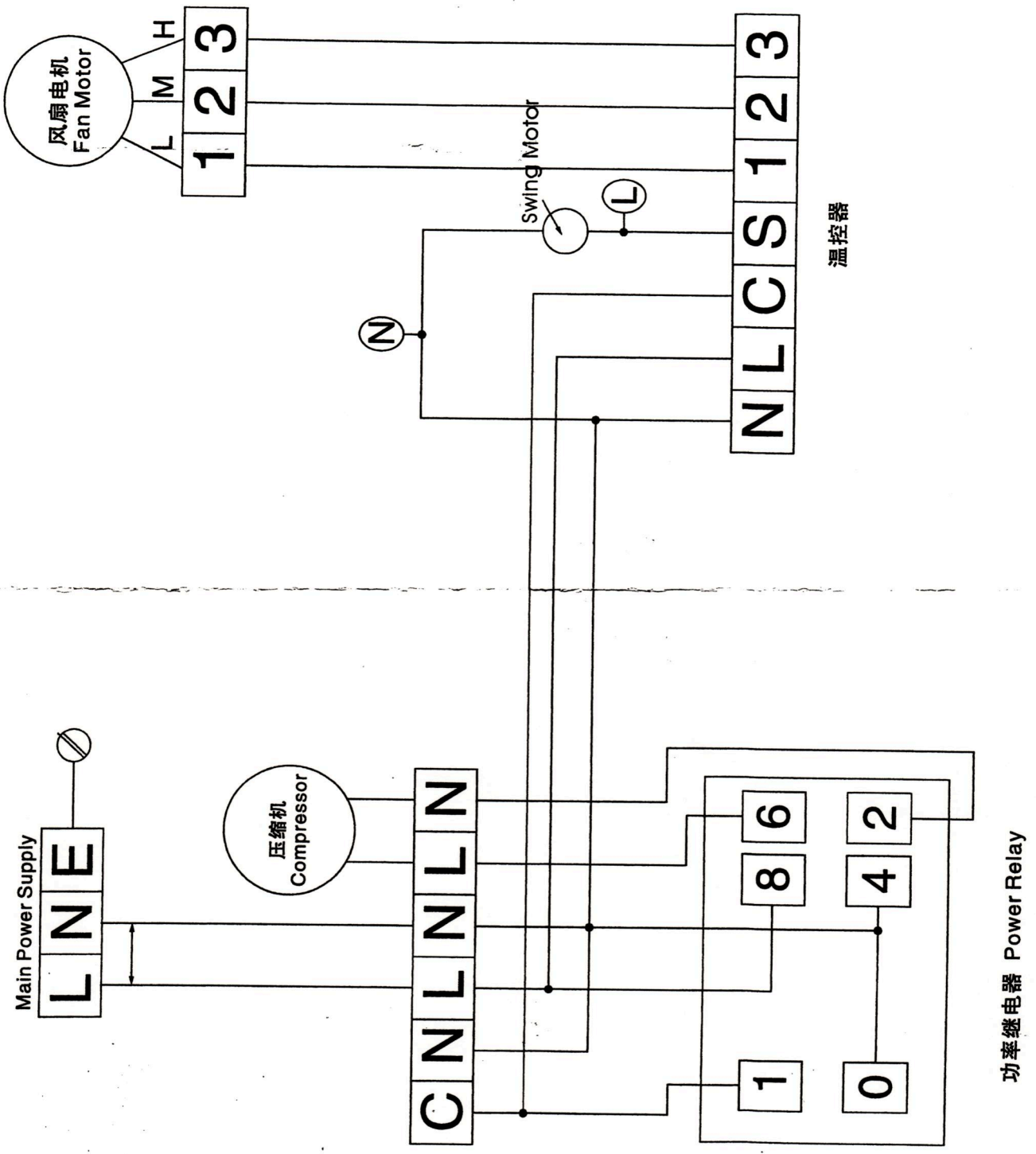

Main Power Supply
L N E

压缩机
 Compressor

C N L N L N

1 0 8 6 4 2

功率继电器 Power Relay

N

Swing Motor

L

N L C S 1 2 3

温控器

1 2 3

L M H

风扇电机
 Fan Motor