



# PRODUCT CATALOGUE

2022



# LIGHT COMMERCIAL

AIR CONDITIONER

# INVERTER TECHNOLOGY



## THE EXCLUSIVE INVERTER QUATTRO™ TECHNOLOGY

A brain that calculates your needs in any conditions

- Up to **71%** Ultra Energy Saving **65Hz in 6 seconds** Flash Cooling
- Within **±1°C** Comfort With Stable Temperature

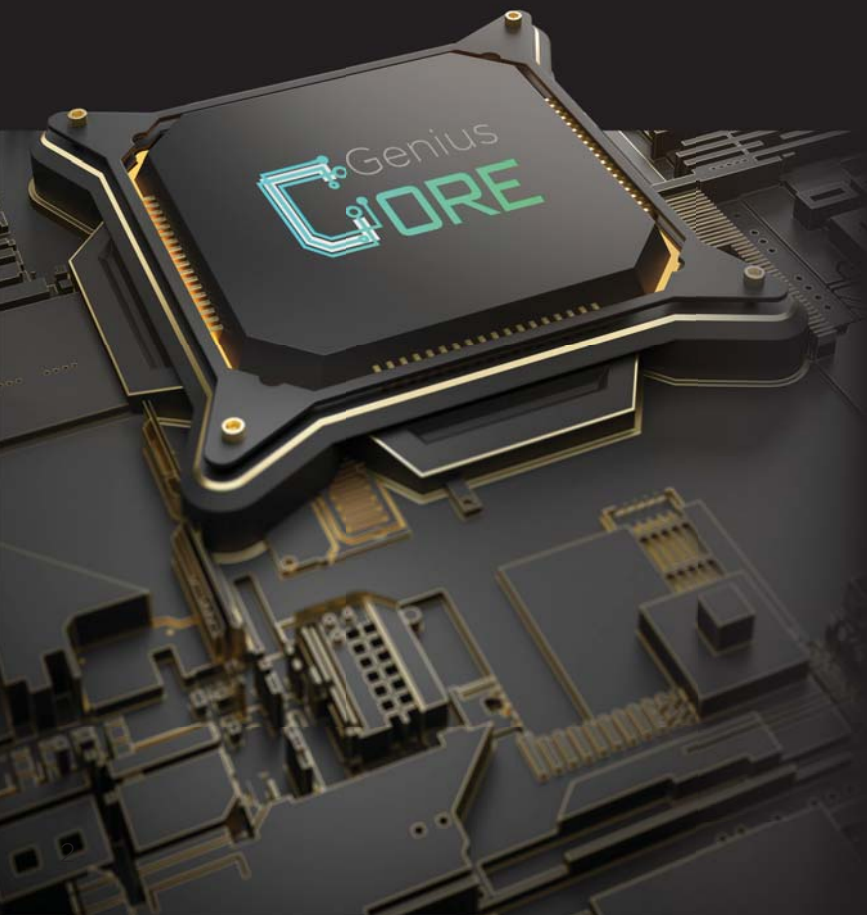

Ordinary Inverter Mode

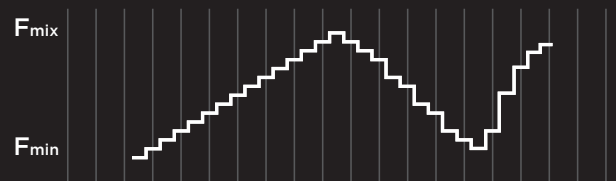

Precise-control Algorithm Inverter Mode

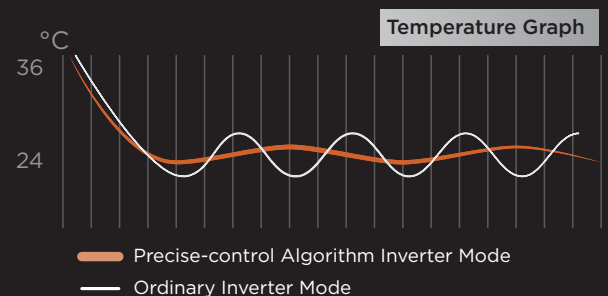
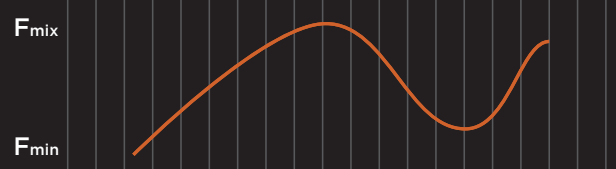



# FULL DC INVERTER SYSTEM

Thanks to the Full DC Inverter System, Midea's air conditioners achieved 20% higher energy efficiency compared to normal AC inverters.

**Sine-Wave DC inverter control**  
High energy efficiency and low noise operation is realized by using a sine-wave DC inverter control

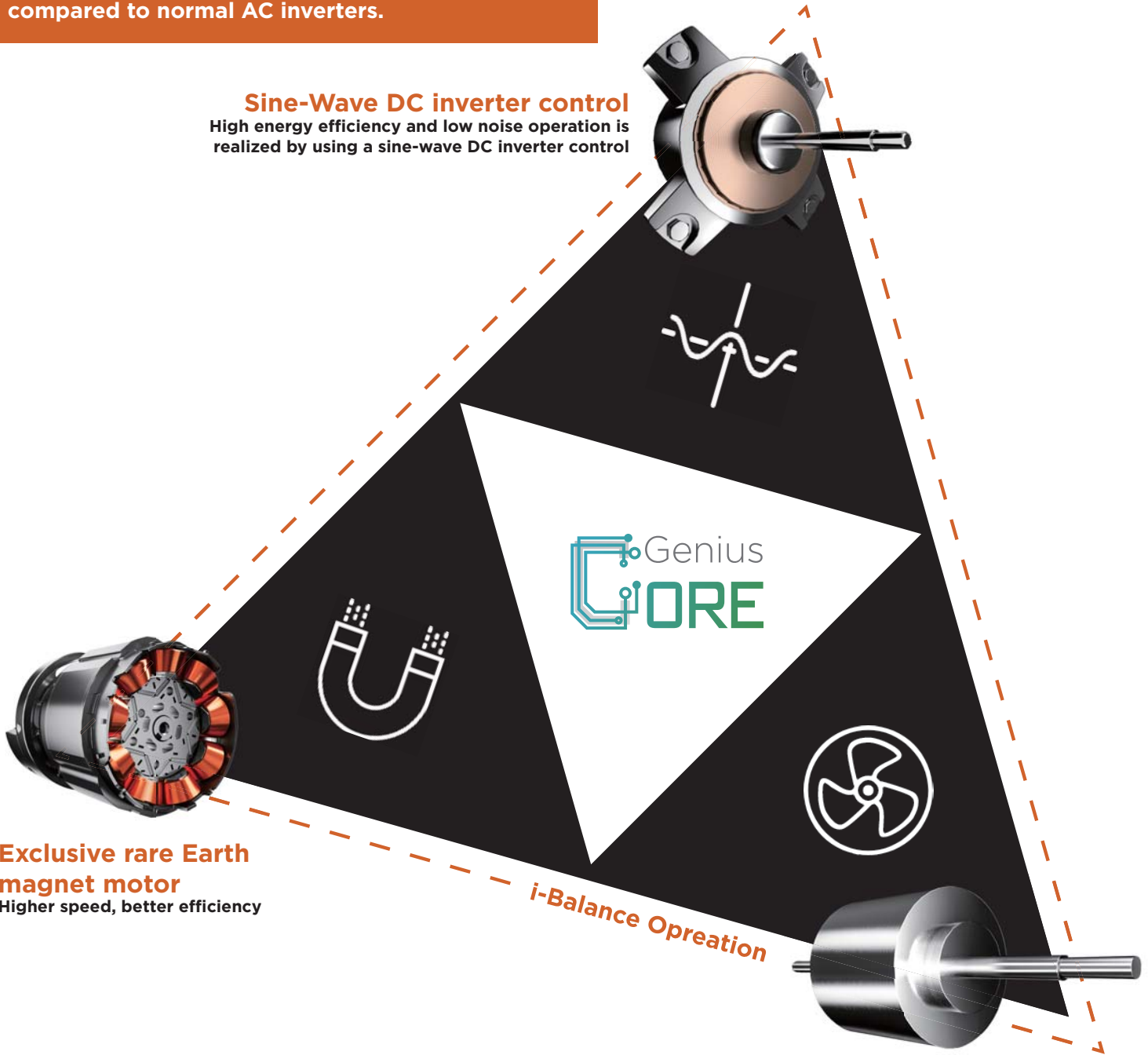

**Exclusive rare Earth magnet motor**  
Higher speed, better efficiency

**IPM DC Fan Motor**  
Produces 10% higher efficiency with smaller size

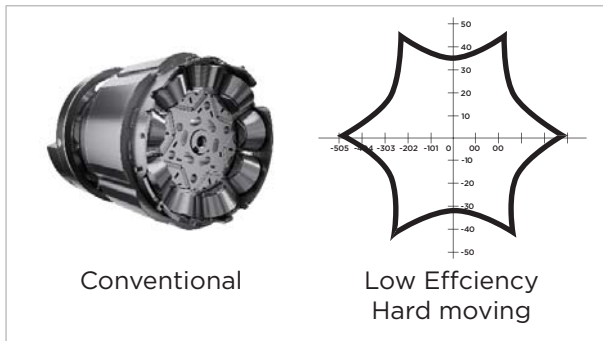
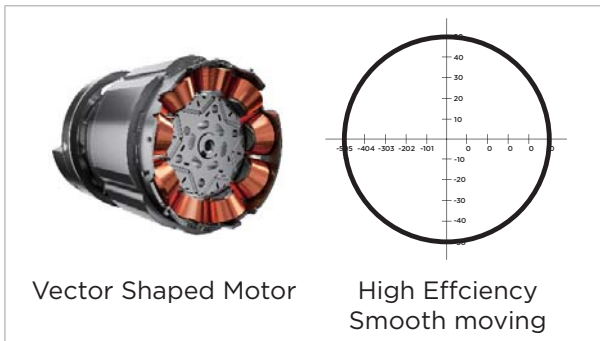

Make the best use of the technology

# HIGHER ENERGY EFFICIENCY

Eco-Friendly and Economic-friendly



## LOWER POWER CONSUMPTION

Midea's air conditioner achieves EERs of 3.72 for cooling operation and COPs of 4.6 for heating operation thanks to Midea's DC Inverter control and the high efficiency tube of the heat exchanger.

Midea former model EER 2.6

increase

# 30%

### Bionic Blower Wheel and Improved Air Duct



Ordinary fan blade design



Midea high static pressure fan blade design

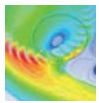

Standard air duct damper

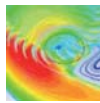

High-efficiency air duct damper

### V-PAM (Vector + I-PAM) Inverter Control

Provide maximum speed and efficiency.

Full DC Inverter Control

Efficiency %

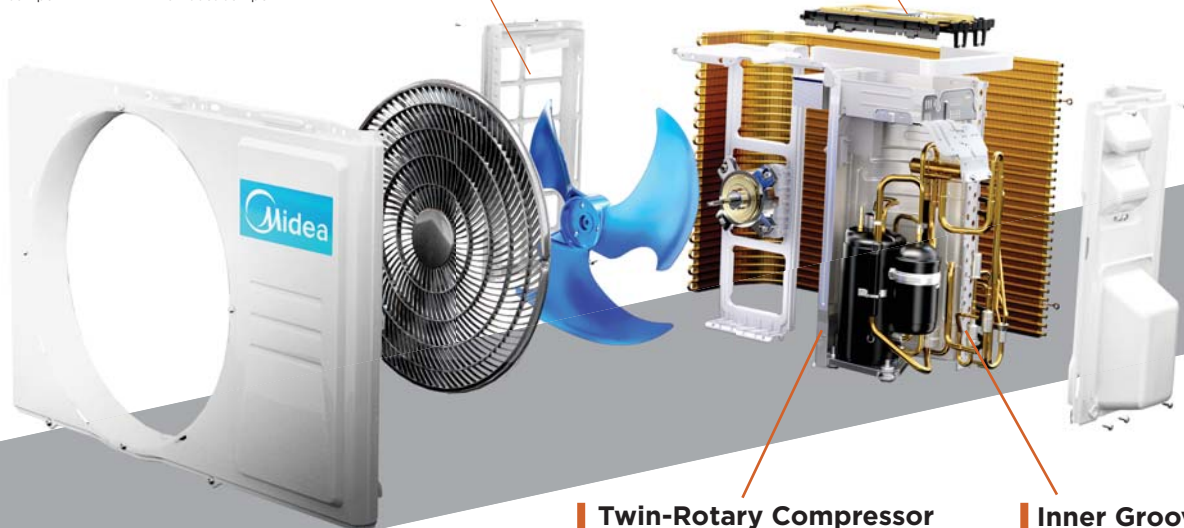
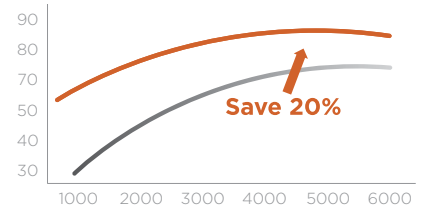

### Twin-Rotary Compressor

Low vibration & noise due to small torque.

### Inner Groove-Tube

Better efficiency of heat transfer.



One click to limit the maximum frequency current while still maintain the room temperature within the optimal temperature, guarantee a cool night sleep with maximum energy saving.

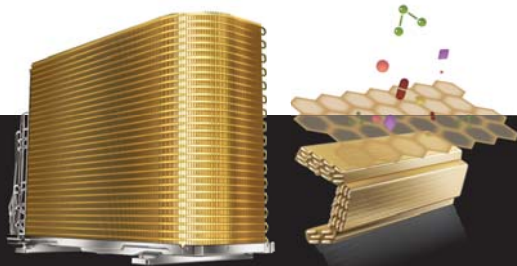

Golden Fin

The golden finned hydrophilic coil efficiently prevents bacteria creating a healthy environment, it can improve heat exchange. The unique anti-corrosive gold plating can withstand salty air, rain and other corrosive elements.



Automatic Temperature Return

The temperature can automatically return to the previous setting point. This function is especially useful for shops or restaurants that return to a higher temperature after the busy hours.

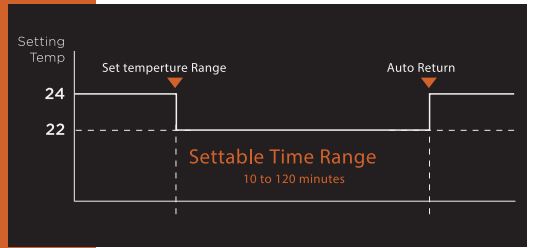

Automatic Time-off

The outdoor unit can automatically turn off when it reaches to the preset operating time frame to prevent energy wasting even when you leave with the AC on.

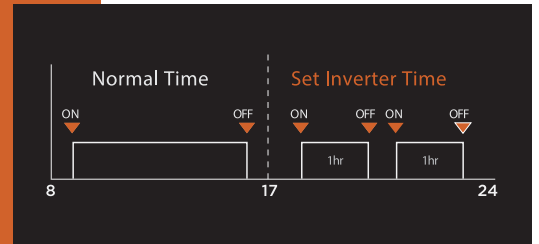

Set Temperature Limitation

The minimum and maximum temperature range can be set giving further energy saving while considering the comfort of the occupants.

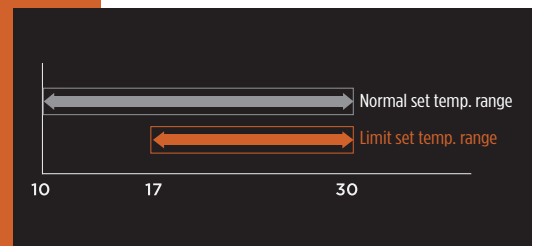

## 30%

### Higher Energy Efficiency Under Partial Load

Higher efficiency can be achieved through partial output mode of the inverter compressor. In situations only a part of rooms that need air conditioning, the outdoor unit will run with partial output to lower the power consumption. Up to 30% less energy use under partial load.

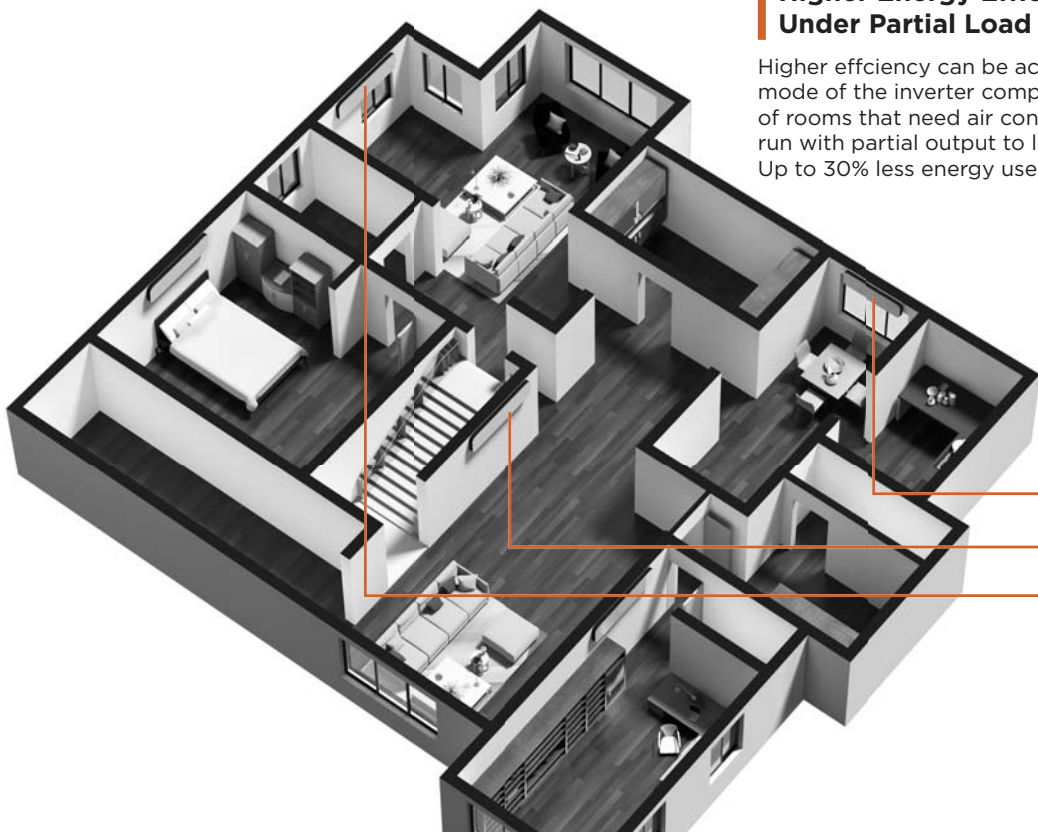



# BETTER COMFORT

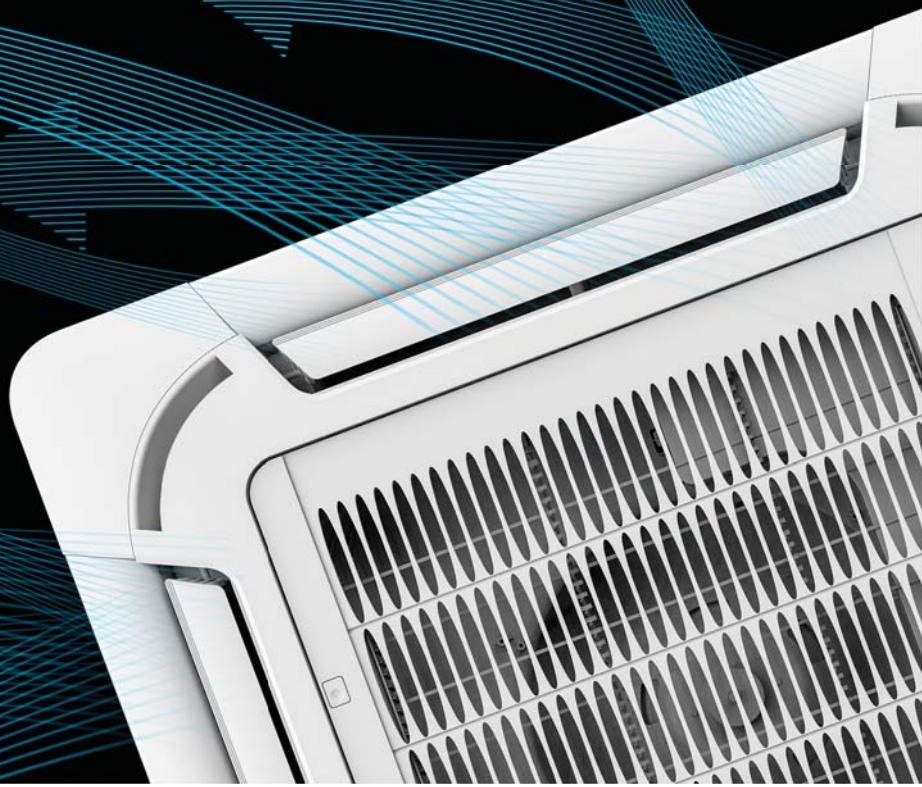

## LOW NOISE TECHNOLOGY

Midea's air conditioner operates at minimum 19dB(A) low noise level.

### Indoor fan design

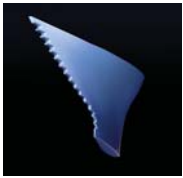

Traditional centrifugal wind turbines



Owl airfoil centrifugal wind turbines

\*Specifications may vary for each model



### Twin-Rotary Compressor

The Twin-Rolling compressor system rotating with 180° symmetrical balance which ensure low vibration and noise due to the small torque.

### Air Stabilizer in Duct

Low noise duct structure with a built-in air stabilizer.



### IPM DC Fan Motor

Midea's exclusive IPM DC Fan Motor feature 35% smaller in size while 10% higher in efficiency, providing substantial air volume and high static pressure, while keeping electrical and mechanical noise lower (1-3dB (A) quieter).



19dB  
MINI DUCT



22dB  
LIBRARY



26dB  
FOREST



41dB  
CEILING & FLOOR



43dB  
CASSETTE

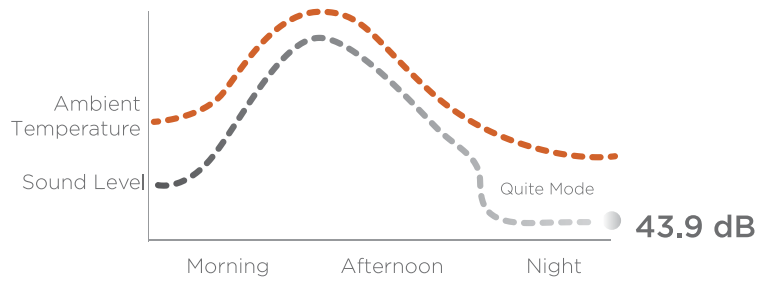

### Low-noise outdoor unit operation

Quiet mode activates when the ambient temperature falls. At the right moment, the outdoor unit will automatically lower the operating frequency of the inverter compressor as well as the speed of the DC fan motor, achieving a minimal 43.9 dB(A) noise level.

# 30%

faster in Cooling

### Fast Cooling

Thanks to the Inverter Quattro™ technology, Midea's air conditioner can increase the speed to approximately 30% in cooling while consuming less energy, by accurately sense the temperature difference and adjust the compressor rotation speed to create optimal and comfortable room temperature.

Changes in Temperature Over 20 Minutes

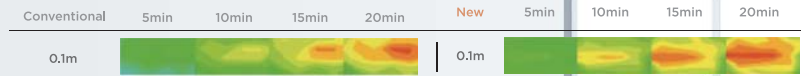

Keeping you steadily cool within

# ± 1°C

### Precise Temperature Control

Thanks to the precise control of the Inverter Quattro™'s micro-chip, Midea's air conditioner can easily maintain the desired temperature by varying the compressor speed without repeatedly turning on and off, keeping you comfortable with steady temperature within 1°C.



## FLEXIBLE ZONING CONTROL

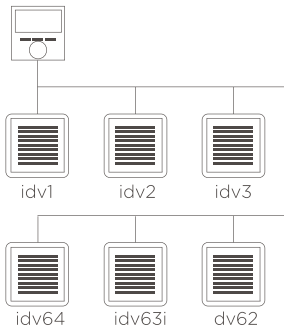

### Convenient Remote Controller

### Max64 Centralized Control



### Weekly Timer



### Sleep Mode

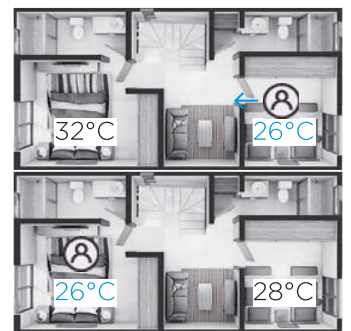

### Follow Me



# HIGHER RELIABILITY

Worry-Free and Guaranteed for Life  
Midea's AC system offers greatly improved reliability for all weather conditions, reducing calls out to site.



45  
teeth

54  
teeth

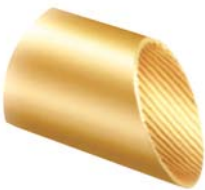

## High-Efficiency Tube

The increased heat exchange area improves the efficiency of heat transfer, allowing faster heating.



## Compressor High Racer Frequency Technology

Like a runner sprinting to the line, this tech enables the compressor to achieve maximum frequency in split of the moment upon start up, providing powerful cooling once the air conditioner is on.

## A HIGH STANDARD SUMMONSA GREATER CHALLENGER

Damp And Salty Areas



## 72-hours ammonia water test



## High Stress-corrosion Resistance

Midea conducts 72-hour anti-stress-corrosion testing for core copper components, exceeding normal 4-hour testing standards by a factor of 18. Results demonstrate that Midea's copper core components perform 15 times better on average than competitors in stress-corrosion resistance.



## Golden Fin Coating

68% stronger hydrophilicity and 3 times higher corrosion resistance compare to the conventional heat exchanger. The patented PrimeGuard™ Coating protects the surface of the heat exchanger from unnecessary wear and corrosion while ensure high efficiency.

## 100-hours Salt Spray Tests

and

## 3000-times Wetting-drying Tests



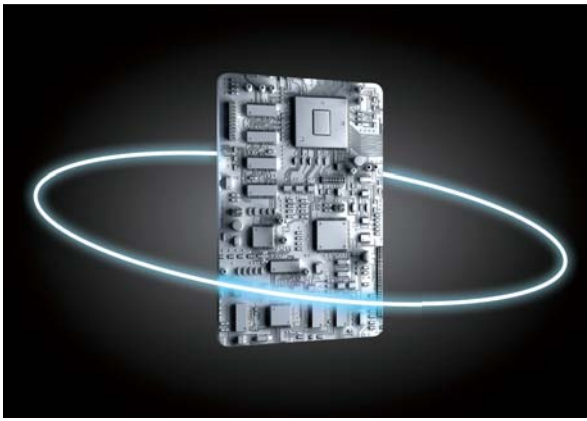

### PCB Protection Design

For better protection of the PCB, using the military grade rubber resin material as coating, further enhance the PCB's resistance to acid and alkali elements (rain and humidity).

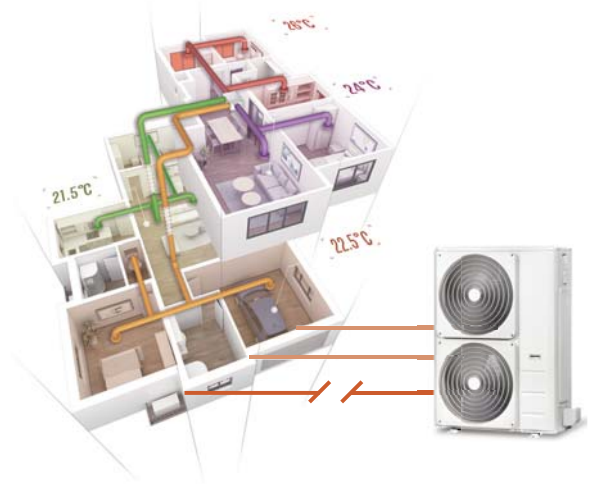

### Continuous Operation of IDU (Multi split type)

Each indoor unit is controlled individually on the system network. This allows all indoor unit will continue to work even if an error might occur at any indoor unit's on the AC system.



### Full Surrounding Design E-box

The indoor unit E-box is fully surrounded by the flame retarding plastic & metal plate material as protection against fire, humidity or small animals.

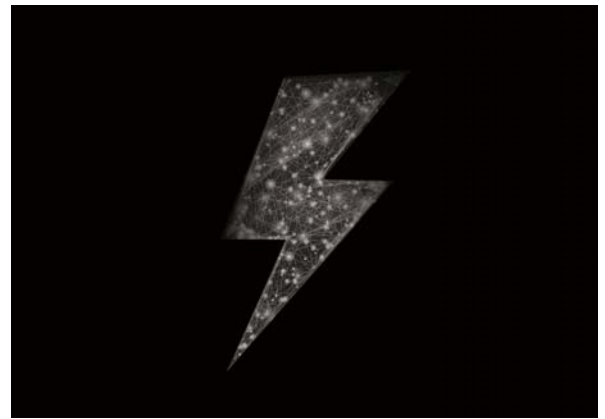

### Wide Voltage Operation Range

The Midea PCB was enhanced to increase its ability to withstand the widest voltage fluctuations from down 150v to 260v, thus ensuring your air conditioner stably running under wide voltage operations without a separate voltage stabilizer.



# MIDEA SPACE SOLUTIONS

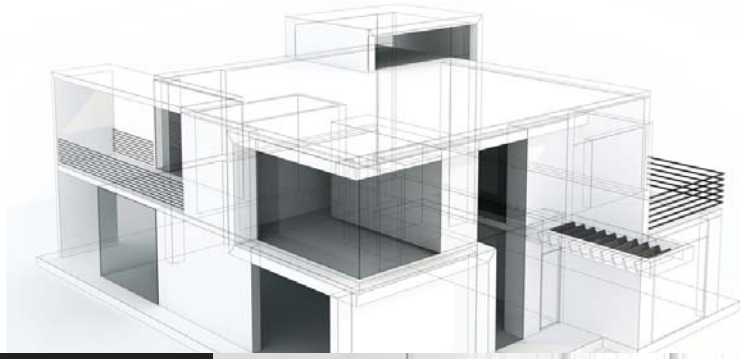

## SMALL OFFICES

Midea offers total air conditioning systems for small-sized offices buildings, taking into account energy saving, low noise, comfortable airflow, small room application and centralized control, ensure optimal experience in every corner at work.



### HARNESSING THE AIRFLOW

#### CASSETTE



### A FULL PORTFOLIO TO MEET A WIDE RANGE OF NEEDS.



Ceiling Concealed



Super Slim Cassette



Ceiling & Floor

### MIDEA PROVIDES MULTIPLE CONTROL OPTIONS TO SUPPORT FLEXIBLE MANAGEMENT AND IMPROVED OPERABILITY.

- Individual Control
- Zoon Control
- BMS Support

## SCHOOLS

Flexible to install and convenient to maintain, total air conditioning solutions for schools are designed for both small spaces like dormitories and large spaces like libraries.



### CANTEEN, AUDITORIUM AND SHARED PLACE

for Every Zone Enough and Even Airflow Volume



Ceiling Concealed



Super Slim Cassette

### LIBRARY

Absolute Quiet for Even the Most Demanding Condition

### A RANGE OF INDOOR UNITS

Various Indoor Units Options with Convenient Control Systems



Ceiling Concealed



Ceiling & Floor



Floor Standing



# HOTELS

Total air conditioning solutions for hotels of all types and sizes. Fresh air, a quiet environment, comfortable airflow, and a range of climate control solutions give your guests the perfect stay. Cost saving is easy with our market-leading energy saving and easy maintenance features.



## FOR PUBLIC SPACES



Super Slim Cassette



Ceiling Concealed

An efficient solution in a range of capacities



12K - 60K



Conventional product

Small Yet Versatile



8% smaller size

New product



## FOR GUEST ROOMS



All Easy Split AC



Ceiling Concealed

# RESTAURANTS & SHOPS

Midea's total air conditioning options create the perfect ambience for restaurants and shops by combining functional and stylistic features. The minimal design of the DUs' appearance allows them to blend naturally into any modern environment, while different systems provide ideal experience for high density of customers.



## SINGLE SPLIT

The Beauty of Invisible Comfort



Super Slim Cassette



Ceiling Concealed



Ceiling Concealed



Ceiling & Floor



Super Slim Cassette

## SIMULTANEOUS MULTI

Twin Systems with Sync Control

## SIMPLE INSTALLATION OPTIONS



Ceiling & Floor



Floor Standing

# RESIDENCES

Midea provides products that match your spaces and the rhythms of your life, from living rooms where the whole family relaxes to small rooms such as bedrooms and children's rooms.



## FOR LARGE LIVING ROOM OR DINING ROOMS

Ceiling Concealed



## FOR MASTER BEDROOM, LIVING ROOM OR KIDS ROOMS

Breezeless Split AC



## FOR SMALL ROOMS OR HOME OFFICES

AF Inverter Split AC

## OUTDOOR UNITS SUITABLE FOR RESIDENTIAL ENVIRONMENTS

Ceiling Concealed



# CEILING CASSETTE



## Super Slim Design (2.0 & 2.5HP only)

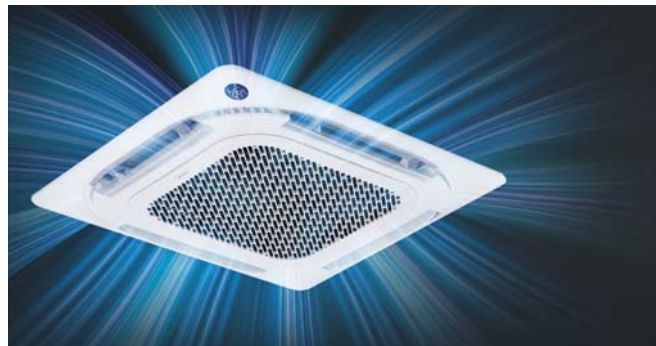

## Cool Surround 360°

Unique seamless airflow louver design equipped with DC fan motor allows cool air to diffuse and sink in 360° direction, offering uniform cooling experience throughout the space.



## Independent Vane Control (By wired controller)

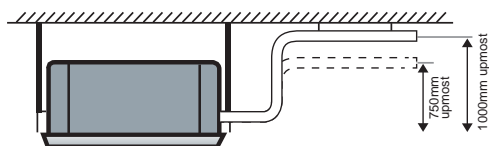

## Built-in Drain Pump

The drain pump can pump the condensing water up to 1000mm.

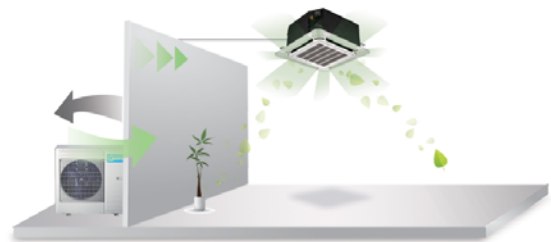

## Fresh Air

Fresh air makes air quality healthier and more comfortable.

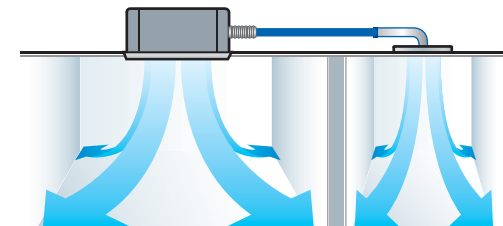

## Reserved Air Outlet

Reserves the space for air outlet from the indoor side; It's available to connect air duct from the four sides to the nearby small rooms.



## Re-structure Water Pump

Water pump re-structure to external, more convenience for service. Over 20% increased airflow with hidden water pump structure, 5% larger heat exchanger, achieve higher energy efficiency, even more lower noise level.



## Wi-Fi Control (App:MSmartLife)

Built in Wi-Fi control function (For Inverter 2.0HP and above only)





# POWER BREEZELESS

Exclusive power breezeless wind deflector contain over 10,800 mini holes. Each mini hole is in hour-glass shape to boosts then disperse the air stream as it funneis through all the mini holes are distributed in different direction and size together turning the strong blast into cool, billowing mist. Provideing you uniquely immersive experience never before. (Breezeless Panel available for Inverter model 2.OHP and above only)

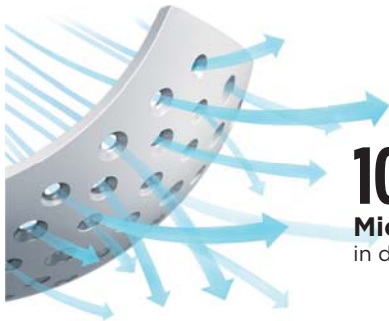

**10,800**  
Micro-Holes  
in different size and directions

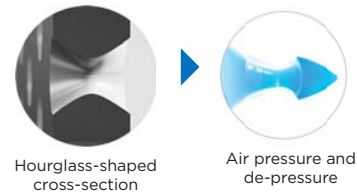

**HOURGLASS-SHAPED**  
Hourglass-shaped micro holes  
compress then emitted the across air stream

## SPECIFICATIONS (Ceiling Cassette Inverter)

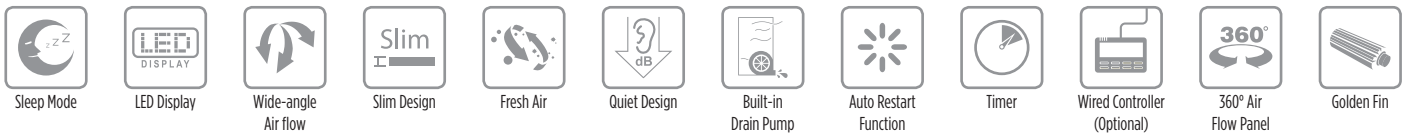

Model name	Indoor model	MCA3-12CRFNX	MCX-24CRFNX	MCX-24CRFNX	MCX-30CRFNX	MCX-36CRFNX	MCX-40CRFNX	MCX-42CRFNX	MCX-48CRFNX	
	Outdoor model	MOUX-12CFN8	MOUX-18CFN8	MOUX-24CFN8	MOUX-30CFN8	MOUX-36CFN8	MOUX-40CFN8	MOUX-42CFN8	MOUX-48CFN8	
Power source	V/ph/Hz	220-240-/1/50	220-240-/1/50	220-240-/1/50	220-240-/1/50	220-240-/1/50	380-415-/3/50	220-240-/1/50	380-415-/3/50	
Cooling capacity	Btu/h	12,000 (2,897-14,020)	18,000 (9,900-19,064)	24,000 (11,263-27,000)	30,000 (7,600-32,000)	36,000 (9,200-39,000)	36,000 (9,200-39,000)	42,000 (10,000-44,000)	48,000 (12,000-54,000)	
Power consumption - Rated (Min-Max)	W	1,010 (168-1,434)	1,633 (720-2,088)	2,320 (780-2,748)	2,750 (190-3,000)	3,950 (900-4,200)	4,000 (890-4,150)	4,200 (680-4,350)	4,650 (800-5,900)	
Running current - Rated (Min-Max)	A	4.45(1.32-6.31)	7.2(3.2-9.2)	10.2(4.2-12)	12.0(2.0-13.0)	17.5(4.2-18.5)	6.5(1.4-6.5)	18.8(3.1-19.1)	8.1(1.8-10.2)	
Indoor	Air flow (High)	m <sup>3</sup> /h (cfm)	569 (335)	1247 (734)	1247 (734)	1700 (1000)	1700 (1000)	1900 (1118)	1900 (1118)	
	Sound pressure (Hi/Mi/Lo)	dB(A)	42/37.5/34.5	45.4/44/39	50/47.5/42	50.5/48/46	51/48/46	51.0/49.0/46.0	52.5/50/47.5	52.5/50.5/48
	Dimension (WxDxH)(body)	mm	570x570x260	830x830x205	830x830x205	830x830x245	830x830x245	830x830x245	830x830x287	830x830x287
	Dimension (WxDxH)(panel)	mm	647x647x50	950x950x55	950x950x55	950x950x55	950x950x55	950x950x55	950x950x55	950x950x55
	Machine Weight (Net/Gross)	Indoor (kg)	16.3/20.4	21.6/25.4	21.6/25.4	24.6/28.6	27.2/31.2	27.2/31.2	29.3/33.5	29.3/33.5
		Panel (kg)	2.5/4.5	6/9	6/9	6/9	6/9	6/9	6/9	6/9
	Design pressure	MPa	4.3/1.7	4.3/1.7	4.3/1.7	4.3/1.7	4.3/1.7	4.3/1.7	4.3/1.7	4.3/1.7
Drainage water pipe diameter	mm	ØDØ25	ØDØ25	ØDØ25	ØDØ25	ØDØ25	ØDØ25	ØDØ25	ØDØ25	
Outdoor	Sound pressure	dB(A)	53.6	56	60	62	63	63	63.5	
	Dimension (WxDxH)	mm	765x303x555	805x330x554	890x342x673	946x410x810	946x410x810	946x410x810	946x410x810	952x415x1333
	Machine weight (Net/Gross)	kg	26.6/29	32.5/35.2	43.9/46.9	52.8/57.3	66.9/71.5	80.5/85	71.0/75.0	103.7/118.3
	Refrigerant charged (5m piping)	kg	R32/ 0.72	R32/1.15	R32/1.5	R32/2.0	R32/2.4	R32/2.4	R32/2.8	R32/2.9
Refrigerant piping	Liquid side/ Gas side	mm (inch)	Ø6.35/Ø9.52 (1/4"/3/8")	Ø6.35/Ø12.7 (1/4"/1/2")	Ø9.52/Ø15.9(3/8"/5/8")					
		Max. pipe length	m	25	30	50	50	75	75	75
	Max. difference in level	m	10	20	25	25	30	30	30	
	Control type (Outdoor)		EXV			EXV+Throttle valve				
	Heat insulation		Both liquid and gas pipe							

Remarks: 1.The above design and specifications are subject to change without prior notice for product improvement.  
2.The values given in the table for the noise level reflect the levels in anechoic chamber.



## SPECIFICATIONS (Ceiling Cassette Non Inverter)



Sleep Mode



LED Display



Wide-angle  
Air flow



Slim Design



Fresh Air



Quiet Design



Built-in  
Drain Pump



Auto Restart  
Function



Timer



Wired Controller  
(Optional)



360° Air  
Flow Panel



Golden Fin

Model name	Indoor model	MCA3-12CRN8	MCDX-18CRN8	MCDX-25CRN8	MCDX-30CRN8	MCDX-36CRN8	MCDX-48CRN8	
	Outdoor model	MOUX-12CN8	MOUX-18CN8	MOUX-25CN8	MOUX-30CN8	MOUX-36CN8	MOUX-48CN8	
Power source	V/ph/Hz	220-240-/1/50	220-240-/1/50	220-240-/1/50	220-240-/1/50	380-415-/3/50	380-415-/3/50	
Cooling capacity	Btu/h	12,000	18,500	25,000	31,000	36,500	48,000	
Power consumption - Rated	W	1,150	1,600	2,400	3,080	3,500	4,600	
Running current - Rated	A	4.5	7	10.5	14	6.5	8.8	
Indoor	Air flow (High)	m <sup>3</sup> /h (cfm)	810 (476)	1200 (706)	1320 (776)	1935 (1138)	1950 (1148)	1950 (1148)
	Sound pressure (Hi/Mi/Lo)	dB(A)	41/37/34	44/37.5/34.5	46/40/37	53/49.5/46	53/49.5/45.5	54/52/49
	Dimension (WxDxH)(body)	mm	570x570x260	830x830x205	830x830x205	830x830x245	830x830x245	830x830x245
	Dimension (WxDxH)(panel)	mm	647x647x50	950x950x55	950x950x55	950x950x55	950x950x55	950x950x55
	Machine weight (Net/Gross)	Indoor (kg)	16.2/19.4	22.2/26	22.2/25.9	25.7/29.8	25.8/29.9	28.0/32.1
		Panel (kg)	2.5/4.5	6/9	6/9	6/9	6/9	6/9
	Design pressure	MPa	4.3/1.7	4.3/1.7	4.3/1.7	4.3/1.7	4.3/1.7	4.3/1.7
	Drainage water pipe diameter	mm	ØDØ25	ØDØ25	ØDØ25	ØDØ25	ØDØ25	ØDØ25
Outdoor	Sound pressure	dB(A)	50.5	57	59	59.5	63	62
	Dimension(WxDxH)	mm	765x303x555	805x330x554	890x342x673	946x410x810	946x410x810	946x410x810
	Machine weight (Net/Gross)	kg	27.3/29.7	38.9/41.5	51.8/55	63.2/68.0	66.1/71	71.5/76.1
	Refrigerant charged (5m piping)	kg	R32/0.43	R32/0.72	R32/1.3	R32/1.7	R32/1.6	R32/1.9
Refrigerant piping	Liquid side/ Gas side	mm (inch)	Ø6.35/Ø9.52 (1/4"/3/8")	Ø6.35/Ø12.7 (1/4"/1/2")	Ø9.52/Ø15.9(3/8"/5/8")			
	Max. pipe length	m	25	25	25	30	30	50
	Max. difference in level	m	10	15	15	20	20	30
	Control type (Outdoor)		Capillary Tube			Throttle valve		
	Heat insulation		Both liquid and gas pipe					

**Remarks:** 1.The above design and specifications are subject to change without prior notice for product improvement.  
2.The values given in the table for the noise level reflect the levels in anechoic chamber.



# CEILING CONCEALED

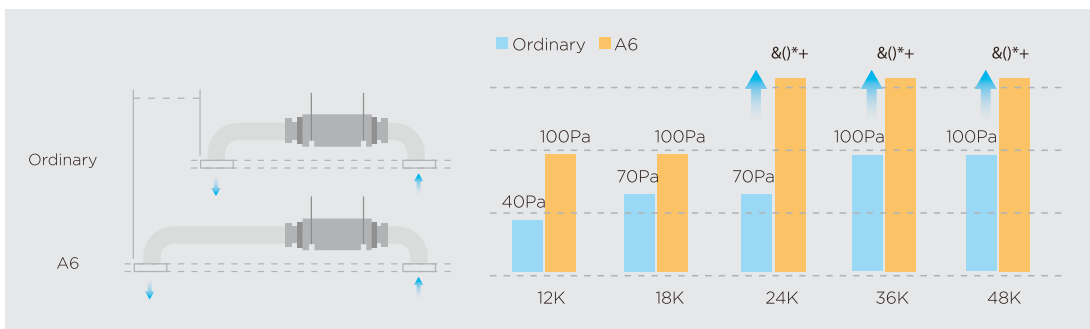

## Up to 160Pa High Static Pressure

With new eccentric fan motor, the A6 Duct can be installed in various application that requires high static pressure up to 160Pa.

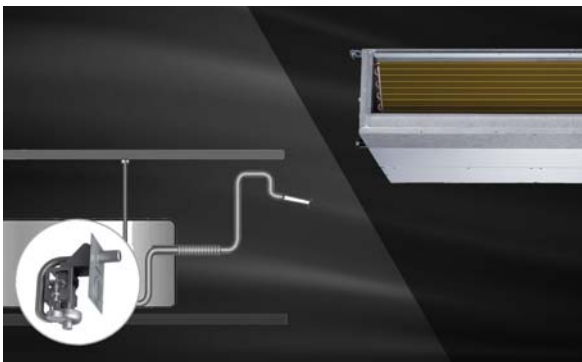

## Built-in Drain Pump

The drain pump can lift the condensing water up to 750mm, which is convenient to install drainage pipes under most conditions. It also allows parts be replaced from the side where maintenance is easier.

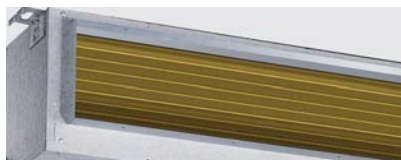

## PrimeGuard Coating for Long-lasting Performance

The unique anti-corrosive golden coating on the heat exchangers can withstand the salty air, rain and other corrosive elements. It also effectively prevents bacteria from breeding and improves heat efficiency.



## Light Weight and Compact Design

With the weight decreases almost 20% and the size shrinks 12.5% in comparison with conventional one, the A6 duct save lots of installation efforts and time as well as creates bigger maintenance space.

# SPECIFICATIONS (Ceiling Concealed Inverter)



Sleep Mode



Timer



Built-in  
Drain Pump



Auto Restart  
Function



Wired Controller  
(Optional)



Golden Fin

Model name	Indoor model	MTI-12CRFNX	MTI-18CRFNX	MTI-24CRFNX	MTI-30CRFNX	MTI-36CRFNX	MTI-40CRFNX	MTI-42CRFNX	MTI-48CRFNX	MTI-60CRFNX	
	Outdoor model	MOUX-12CFN8	MOUX-18CFN8	MOUX-24CFN8	MOUX-30CFN8	MOUX-36CFN8	MOUX-40CFN8	MOUX-42CFN8	MOUX-48CFN8	MOUX-60CFN8	
Power source	V/ph/Hz	220-240-/1/50	220-240-/1/50	220-240-/1/50	220-240-/1/50	220-240-/1/50	380-415-/3/50	220-240/1/50	380-415-/3/50	380-415-/3/50	
Cooling capacity	Btu/h	12,000 (1,800-13,607)	18,000 (8,700-20,000)	24,000 (11,180-27,830)	30,000 (7,600-33,600)	36,000 (9,400-38,000)	36,000 (9,300-40,200)	41,000 (10,000-42,000)	48,000 (12,000-53,000)	52,000 (14,000-59,000)	
Power consumption - Rated (Min-Max)	W	1,053 (155-1,375)	1,530 (710-2,150)	2,190 (750-2,960)	2,500 (190-3,050)	3,950 (900-4,150)	4,000 (890-4,200)	4,200 (680-4,500)	4,800 (880-6,000)	5,250 (1,030-6,650)	
Running current - Rated (Min-Max)	A	4.75 (1.3-6.09)	71 (3.2-9.56)	10.2 (4.2-13.2)	11.0 (2.0-13.5)	17.5 (4.2-18.5)	6.5 (1.4-6.7)	18.8 (3.1-19.8)	8.4 (1.9-10.4)	9.6 (3.1-11.5)	
Indoor	Air flow (without duct) (High)	m <sup>3</sup> /h (cfm)	600 (353)	911 (536)	1229 (723)	2100 (1235)	2100 (1235)	2100 (1235)	2400 (1412)	2400 (1412)	2600 (1529)
	External static pressure - Rated	Pa	25	25	25	37	37	37	50	50	50
	External static pressure - Range	Pa	0-60	0-100	0-160	0-160	0-160	0-160	0-160	0-160	0-160
	Sound pressure(Hi/Mi/Lo)	dB(A)	34.5/32/30	42/39/35	49/46/41	50.5/48/46	50/48/46	50.5/49/47	51.5/49/48	51.5/49/47	52.5/49/47
	Dimension (WxDxH)	mm	700x506x200	880x674x210	1100x774x249	1360x774x249	1360x774x249	1360x774x249	1200x874x300	1200x874x300	1200x874x300
	Machine Weight (Net/Gross)	kg	17.8/21.5	24.4/29.6	32.3/39.1	40.5/48.3	40.5/48.2	40.5/48.2	47.6/55.8	47.6/55.8	47.4/56.1
	Drainage pipe diameter	mm	ØDØ25	ØDØ25	ØDØ25	ØDØ25	ØDØ25	ØDØ25	ØDØ25	ØDØ25	ØDØ25
Outdoor	Sound pressure	dB(A)	53.6	56	60	62	63	63	63	63.5	64
	Dimension (WxDxH)	mm	765x303x555	805x330x554	890x342x673	946x410x810	946x410x810	946x410x810	946x410x810	952x415x1333	952x415x1333
	Machine weight (Net/Gross)	kg	26.6/29	32.5/35.2	43.9/46.9	52.8/57.3	66.9/71.5	80.5/85	71.0/75.0	103.7/118.3	107.0/121.2
	Refrigerant charged (5m piping)	kg	R32/ 0.72	R32/1.15	R32/1.5	R32/2.0	R32/2.4	R32/2.4	R32/2.8	R32/2.9	R32/3.0
Refrigerant piping	Liquid side/ Gas side	mm (inch)	Ø6.35/Ø9.52 (1/4"/3/8")	Ø6.35/Ø12.7 (1/4"/1/2")	Ø9.52/Ø15.9(3/8"/5/8")						
	Max. pipe length	m	25	30	50	50	75	75	75	75	75
	Max. difference in level	m	10	20	25	25	30	30	30	30	30
	Control type (Outdoor)	EXV			EXV+Throttle valve						
	Heat insulation	Both liquid and gas pipe									

Remarks: 1.The above design and specifications are subject to change without prior notice for product improvement.  
2.The values given in the table for the noise level reflect the levels in anechoic chamber.

# SPECIFICATIONS (Ceiling Concealed Non Inverter)



Sleep Mode



Timer



Built-in  
Drain Pump



Auto Restart  
Function



Wired Controller  
(Optional)



Golden Fin

Model name	Indoor model	MTI-18HRN1	MTI-24HRN1	MTI-36HRN1	MTI-48HRN1	MTI-60HRN1		
	Outdoor model	MOU-18HNI	MOU-24HNI	MOU-36HNI	MOU-48HNI	MOU-60HNI		
Power source	V/ph/Hz	220-240-/1/50	220-240-/1/50	380-415-/3/50	380-415-/3/50	380-415-/3/50		
Cooling capacity	Btu/h	18,000	24,000	36,000	48,000	60,000		
Power consumption - Rated	W	2,200	2,870	3,650	5,350	6,360		
Running current - Rated (Min-Max)	A	9.7	13.5	6.1	9.2	11		
Indoor	Air flow (without duct)(High)	m <sup>3</sup> /h (cfm)	978 (575)	1359 (799)	1804 (1061)	2150 (1265)	2400 (1412)	
	External static pressure - Rated	Pa	25	25	37	50	50	
	External static pressure - Range	Pa	0-60	0-80	0-100	0-160	0-160	
	Sound pressure(Hi/Mi/Lo)	dB(A)	44.4/42.1/39.5	43.6/40.5/37.9	47/40.5/38	48.0/45.0/42.0	51.7/46.9/44.4	
	Dimension (WxDxH)	mm	880x674x210	1100x774x249	1100x774x249	1200x874x300	1200x874x300	
	Machine weight (Net/Gross)	kg	23.8/29.5	32.2/39	32.2/39.4	46/54.5	46/54.5	
	Drainage pipe diameter	mm	ØDØ25	ØDØ25	ØDØ25	ØDØ25	ØDØ25	
Outdoor	Sound pressure	dB(A)	58	59.8	63	62	62.8	
	Dimension (WxDxH)	mm	770x300x555	845x363x702	946x410x810	900x350x1170	900x350x1170	
	Machine weight (Net/Gross)	kg	36.5/39.7	52.7/56.1	74.4/78.9	98.6/109.3	99.7/111.2	
	Refrigerant charged (5m piping)	kg	R410A/1.5	R410A/1.8	R410A/2.85	R410A/3.3	R410A/3.3	
Refrigerant piping	Liquid side/ Gas side	mm (inch)	Ø6.35/Ø12.7 (1/4"/1/2")	Ø9.52/Ø15.9 (3/8"/5/8")	Ø9.52/Ø19 (3/8"/3/4")			
	Max. pipe length	m	25	25	25	50	50	
	Max. difference in level	m	15	15	15	30	30	
	Control type (Outdoor)	Capillary Tube			Throttle valve			
	Heat insulation	Both liquid and gas pipe						

Remarks: 1.The above design and specifications are subject to change without prior notice for product improvement.  
2.The values given in the table for the noise level reflect the levels in anechoic chamber.



# CEILING & FLOOR



## 2-Style Installation

Fashionable design and streamline appearance, suitable for different room styles.



## 3D Airflow

The unit has horizontal swing and auto vertical swing function, which supplies more even and comfortable air flow.



## Easy Maintenance

More than 60% parts and assemblies (such as fan wheels, plastic cases, metal parts etc.) are universal for 3 different bodies, which makes the production and maintenance much easier.



## Fresh Air

Air outside can be led into the room via a connection pipe, which keeps the indoor air fresh and healthy.

# SPECIFICATIONS (Ceiling & Floor Inverter)



Sleep Mode



Timer



Quiet Design



Fresh Air



2-way Draining



Auto Restart Function



Wired Controller (Optional)



3D Airflow



Golden Fin

Model name	Indoor model	MUE-18CRFNX	MUE-24CRFNX	MUE-36CRFNX	MUE-36CRFNX	MUE-40CRFNX	MUE-48CRFNX	MUE-60CRFNX	
	Outdoor model	MOUX-18CFN8	MOUX-24CFN8	MOUX-30CFN8	MOUX-36CFN8	MOUX-40CFN8	MOUX-48CFN8	MOUX-60CFN8	
Power source	V/ph/Hz	220-240-1/50	220-240-1/50	220-240-1/50	220-240-1/50	380-415-3/50	380-415-3/50	380-415-3/50	
Cooling capacity	Btu/h	18,000 (9,250-20,000)	24,000 (10,990-26,500)	30,000 (7,600-32,000)	36,000 (9,300-39,000)	36,000 (9,300-40,200)	48,000 (12,000-52,000)	5,4000 (14,000-57,000)	
Power consumption - Rated (Min-Max)	W	1,450 (670-2,027)	2,300 (747-2,930)	2,750 (190-3,000)	3,900 (900-4,250)	4,000 (890-4,300)	5,000 (900-5,950)	5,650 (1,100-6,650)	
Running current - Rated (Min-Max)	A	6.0 (3.2-9.0)	10.5 (3.9-13.1)	12.0(4.0-13.0)	17.0(4.2-19.0)	6.30 (1.4-6.80)	8.8 (1.9-10.3)	9.7 (3.2-11.5)	
Indoor	Air flow (High)	m <sup>3</sup> /h (cfm)	958 (563)	1192 (701)	1955 (1150)	1955 (1150)	1955 (1150)	2100 (1235)	2200 (1294)
	Sound pressure (Hi/Mi/Lo)	dB(A)	44/41/37	51/47/43	51.5/48/45	51.5/48/45	51/47.5/45	53/50/46	55/52/48
	Dimension (WxDxH)(body)	mm	1068x675x235	1068x675x235	1650x675x235	1650x675x235	1650x675x235	1650x675x235	1650x675x235
	Machine weight (Net/Gross)	kg	28/33.3	28/33.1	41.5/48	41.5/48	41.5/48	41.7/48.5	42.3/49.2
	Design pressure	MPa	4.3/1.7	4.3/1.7	4.3/1.7	4.3/1.7	4.3/1.7	4.3/1.7	4.3/1.7
	Drainage pipe diameter	mm	ØDØ25	ØDØ25	ØDØ25	ØDØ25	ØDØ25	ØDØ25	ØDØ25
Outdoor	Sound pressure	dB(A)	56	60	62	63	63	63.5	64
	Dimension (WxDxH)	mm	805x330x554	890x342x673	946x410x810	946x410x810	946x410x810	952x415x1333	952x415x1333
	Machine weight (Net/Gross)	kg	32.5/35.2	43.9/46.9	52.8/57.3	66.9/71.5	80.5/85	103.7/118.3	107.0/121.2
	Refrigerant charged (5m piping)	kg	R32/1.15	R32/1.5	R32/2.0	R32/2.4	R32/2.4	R32/2.9	R32/3.0
Refrigerant piping	Liquid side/ Gas side	mm (inch)	Ø6.35/Ø12.7 (1/4"/1/2")						
	Max. pipe length	m	30	50	50	75	75	75	75
	Max. difference in level	m	20	25	25	30	30	30	30
	Control type (Outdoor)		EXV	EXV+Throttle valve					
	Heat insulation		Both liquid and gas pipe						

**Remarks:** 1.The above design and specifications are subject to change without prior notice for product improvement.  
2.The values given in the table for the noise level reflect the levels in anechoic chamber.

# SPECIFICATIONS (Ceiling & Floor Non Inverter)



Sleep Mode



Timer



Quiet Design



Fresh Air



2-way Draining



Auto Restart Function



Wired Controller (Optional)



3D Airflow



Golden Fin

Model name	Indoor model	MUE-25CRNX	MUE-36CRNX	MUE-36CRNX	MUE-48CRNX	
	Outdoor model	MOUX-25CN8	MOUX-30CN8	MOUX-36CN8	MOUX-48CN8	
Power source	V/ph/Hz	220-240-1/50	220-240-1/50	380-415-3/50	380-415-3/50	
Cooling capacity	Btu/h	25,000	31,000	36,000	48,000	
Power consumption - Rated	W	2,400	3,100	3,650	4,700	
Running current - Rated	A	10.5	15	6.6	8.5	
Indoor	Air flow (High)	m <sup>3</sup> /h (cfm)	1194 (702)	1750 (1029)	1750 (1029)	2220 (1306)
	Sound pressure (Hi/Mi/Lo)	dB(A)	52/47/44	52.5/48.5/45	52.5/48.5/45	55/49/46
	Dimension (WxDxH)(body)	mm	1068x675x235	1285x675x235	1285x675x235	1650x675x235
	Machine weight (Net/Gross)	kg	24.4/29.3	29.5/34.8	29.5/34.8	39.5/45.9
	Design pressure	MPa	4.3/1.7	4.3/1.7	4.3/1.7	4.3/1.7
	Drainage pipe diameter	mm	ØDØ25	ØDØ25	ØDØ25	ØDØ25
Outdoor	Sound pressure	dB(A)	59	59.5	63	62
	Dimension (WxDxH)	mm	890x342x673	946x410x810	946x410x810	946x410x810
	Machine weight (Net/Gross)	kg	51.8/55	63.2/68.0	66.1/71	71.5/76.1
	Refrigerant charged (5m piping)	kg	R32/1.3	R32/1.7	R32/1.6	R32/1.9
Refrigerant piping	Liquid side/ Gas side	mm (inch)	Ø9.52/Ø15.9(3/8"/5/8")			
	Max. pipe length	m	25	30	30	50
	Max. difference in level	m	15	20	20	30
	Control type (Outdoor)		Throttle valve			
	Heat insulation		Both liquid and gas pipe			

**Remarks:** 1.The above design and specifications are subject to change without prior notice for product improvement.  
2.The values given in the table for the noise level reflect the levels in anechoic chamber.



# AirFeel Tower FLOOR STANDING

## 1 New Shape Brings 6 Reshape

### 01 Reshape The Space

Truly Seamlessly Fit In Your Space

A Size Of **0.164 m<sup>2</sup>**

- Covers smaller area
- Seamlessly fit in the corner without hiding dirt behind
- Release more space for your furniture

**0.164 m<sup>2</sup>**

### 02 Reshape The Speed

Vertical Air Outlet, Larger Airflow Volumn, Faster Cooling

**895mm**  
Lengthen Air outlet

**125mm**  
Widen Air outlet

**7200W**  
Strong Cooling Capacity

**1300m<sup>2</sup>/h**  
Surging Airflow Volumn

**125mm**

**1300m<sup>2</sup>/h**

**895mm**

- Vertical air outlet design generates powerful jet, guarantees effective cooling even for large spaces.

### 03 Reshape The Surrounding

Feel The Immersive Cool From Every Sides Of Your Room

**895 x 125mm**  
Larger Air outlet

**110°**  
Airflow Angles

- Larger air outlet means a broader airflow angles
- Allows the cool air to reach every corner, ensuring even and comfortable cooling experience across the room.

**110°**

### 04 Reshape The Sense

Flexibly Control The Cool Airflow In The Way You Need

With the patented airflow control technology that caters to your different cooling needs.



Straight Cool Airflow



Wind Avoid Airflow



Softer Waving Airflow

### 05 Reshape The Flexi

Even Cooling, Even From Head To Toe

sleep



rest



motion



0 20 40 60 80 100

- 0 - 100 stepless fan speed regulation, offering meticulous temperature control
- Lengthen and widen air outlet delivers even cool air from head to toe, providing unprecedented cooling experience

# 06 Reshape The Silence

Enjoy More Even Coolness With Less Noise

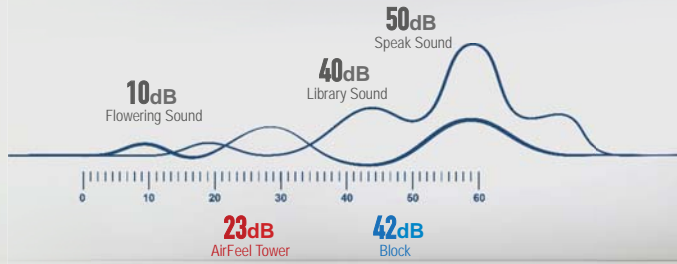

An enlarged air outlet can deliver stronger airflow more evenly with less components resonance, and so cut the noise.



## Intuitive Slide Touch

Brings Function And Style To Your Home

- Slide Touch Control**  
 Gives you higher comfort in both visual and interactive experience. It enables the quick and precise control you need over different temperature, programs and settings.
- VLED Display**  
 Not only to add a touch of style to the panel, but also make the digits clearer to read from every angle.
- Dimmable Lights**  
 Match to multiple lighting and design aesthetic of your home.



## Dual-Health Guard

Take A Fresh Breath, Every Time

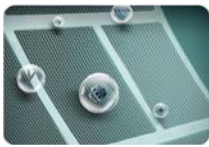

### Dust Proof

High density filter together with intelligent dusting switch technology, getting you rid of the dust from the outside in.

### Mildew Proof

Activate the **Smart self-clean** program of the heat exchanger with just one touch, you can enjoy the clean and fresh air every time you with your AC.

# SPECIFICATIONS (AirFeel Tower Floor Standing)



Sleep Mode



Timer



Quiet Design



Auto Restart Function



Golden Fin

TYPE		Inverter	
Model name	Indoor model	MFYA-24ARFNI	
	Outdoor model	MOUX-24ARFNI	
Power source	V/ph/Hz	220-240-1/50	
Cooling capacity	Btu/h	24,000 (11,263-27,000)	
Power consumption - Rated	W	2,340 (780-2,748)	
Running current - Rated	A	10.4 (4.2-12)	
Indoor	Air flow (High)	m <sup>3</sup> /h (cfm)	990 (582)
	Sound pressure (Hi/Mi/Lo)	dB(A)	39.5/34.5
	Dimension (WxDxH)(body)	mm	405x405x1775
	Machine weight (Net/Gross)	kg	29.9/38.4
Outdoor	Sound pressure	dB(A)	58.5
	Dimension (WxDxH)	mm	890x342x673
	Machine weight	kg	44.7/47.9
	Refrigerant charged (5m piping)	kg	R410A/1.95
Refrigerant piping	Liquid side/ Gas side	mm (inch)	Ø6.35(1/4")/Ø12.7(1/2")
	Max. pipe length	m	50
	Max. difference in level	m	25
	Control type (Outdoor)		EXV
	Heat insulation		Both liquid and gas pipe

**Remarks:** 1.The above design and specifications are subject to change without prior notice for product improvement.  
2.The values given in the table for the noise level reflect the levels in anechoic chamber.



# GA FLOOR STANDING



## Front Air Inlet

The air inlet is located at the front of the unit to ensure better air intake.



## Auto Restart

In the event of a sudden power failure, air conditioner restarts automatically and will operate based on the previous setting.



## Golden Fin

The innovative anti-corrosion coating on the fin helps to prevent bacteria and enhance the efficiency of heat transfer.



## Self-Diagnosis & Auto-Protection

In the case of abnormal operation, the unit will protect the system by shutting down automatically. Meanwhile the error code enables engineers to identify the problem quickly.



## SPECIFICATIONS (GA Floor Standing R32 Non Inverter)



Quiet Design



Self-diagnosis & Auto-protection



LCD Display



Auto Restart Function



Easy Cleaning Panel



Silver Ion Filter



Golden Fin

Model name	Indoor model		MFGA-25CRNX	MFGA-48CRNX
	Outdoor model		MOUX-25CN8	MOUX-48CN8
Power source	V/ph/Hz		220-240-/1/50	380-415-/3/50
Cooling capacity	Btu/h		25,000	48,000
Power consumption - Rated	W		2,460	5,250
Running current - Rated	A		11	8.8
Indoor	Air flow (High)	m <sup>3</sup> /h (cfm)	1,130 (665)	1,800 (1,059)
	Sound pressure (Hi/Mi/Lo)	dB(A)	52.2/47.5	55.6/52.2
	Dimension (WxDxH)(body)	mm	510x240x1695	550x350x1800
	Machine weight (Net/Gross)	kg	31.4/44	48.8/64.4
Outdoor	Sound pressure	dB(A)	59.5	63
	Dimension (WxDxH)	mm	890x342x673	946x410x810
	Machine weight	kg	51.8/55	71.5/76.1
	Refrigerant charged (5m piping)	kg	R32/1.3	R32/1.9
Refrigerant piping	Liquid side/ Gas side	mm (inch)	Ø9.52/Ø15.9(3/8"/5/8")	
	Max. pipe length	m	25	50
	Max. difference in level	m	15	30
	Control type (Outdoor)	Throttle valve		
	Heat insulation	Both liquid and gas pipe		

**Remarks:** 1.The above design and specifications are subject to change without prior notice for product improvement.  
2.The values given in the table for the noise level reflect the levels in anechoic chamber.

# MULTI SPLIT OVERVIEW

Simultaneous Multi-type is recommended for situations where multiple indoor units need to be operated simultaneously such as small buildings, small office building entrances, meeting rooms, education facility halls, and other large spaces. The same 2 indoor units can be operated simultaneously. This type is suitable for office spaces with large areas and properties with unusual floor layout.

# COMPACT ODU DESIGN

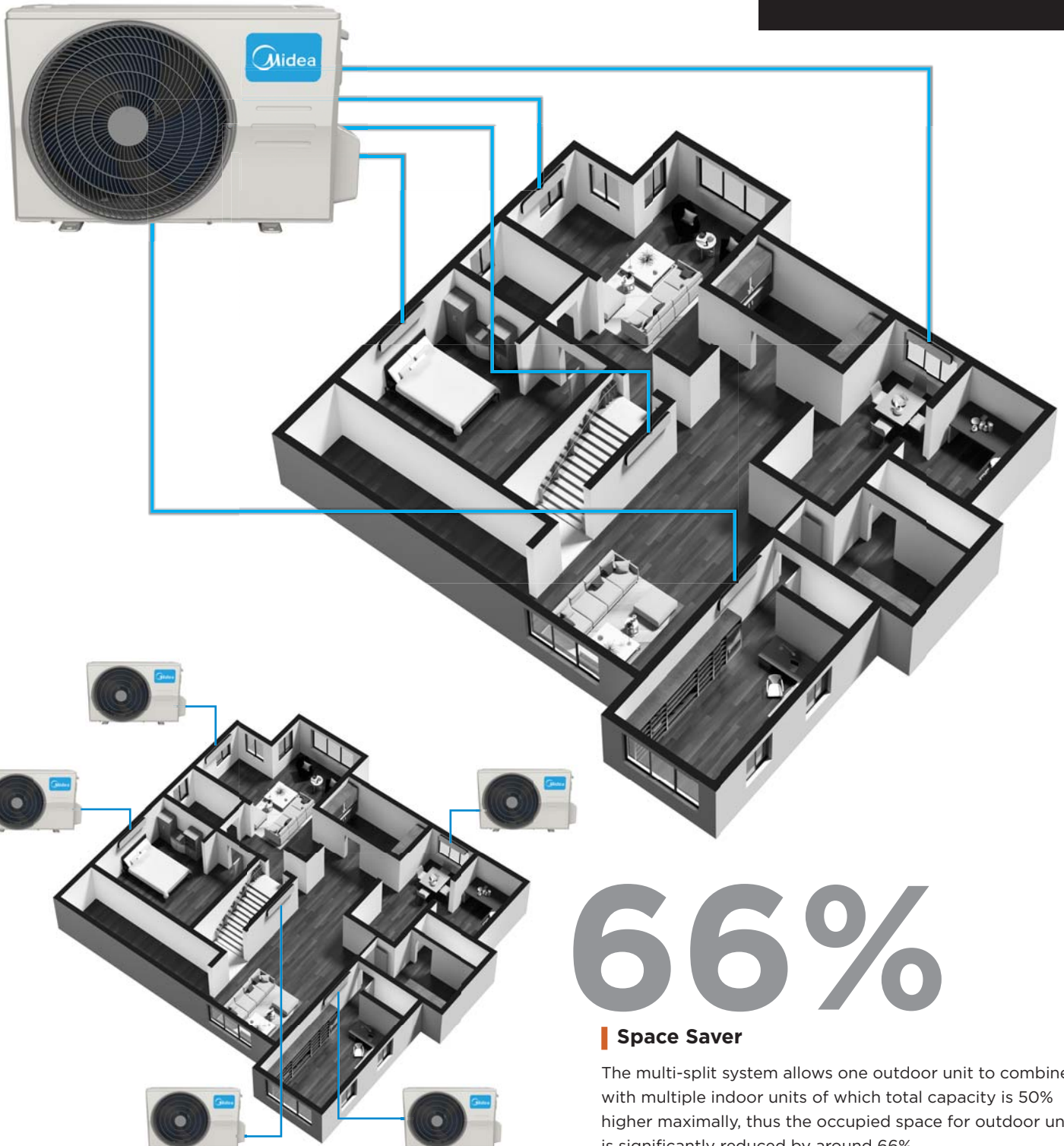

The Midea split system provides tailored solutions for spaces with multiple rooms of different shapes and sizes.



1-2 ROOMS NEOLIGHT



3, 4-5 ROOMS NEOFLEX

# 66%

## Space Saver

The multi-split system allows one outdoor unit to combine with multiple indoor units of which total capacity is 50% higher maximally, thus the occupied space for outdoor unit is significantly reduced by around 66%.

# 1-2 ROOMS NEOLIGHT



Compact Cassette

Ceiling Concealed

Wall Mounted Split AC

## UNITS TO MEET YOUR NEEDSWIDE ARRAYS OF INDOOR

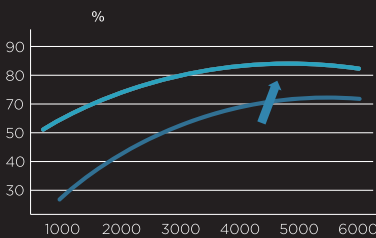

### High Energy Efficiency

Full DC Inverter system is used for compressor, indoor / outdoor fan motor and inverter controlling.

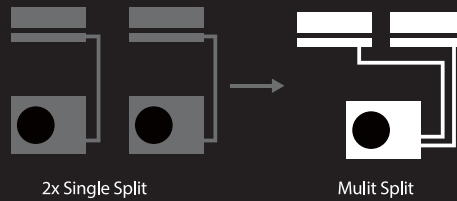

2x Single Split

Mult Split

### Space-saving Installation

Multiple indoor units can be connected to 1 outdoor unit, and long piping connection is also possible, which is especial friendly to small condos that have limited installation space and location.

Outdoor Units	Max Length		Height Difference
	For all rooms	For one indoor unit	
1 Drive 2	40m	25m	15m
1 Drive 3	60m	30m	15m
1 Drive 4&5	80m	35m	15m

### Flexible Installation

Up to max. piping length of 80 m, max. height difference of 15 m can be supported. Midea allows you to choose the best place to install the outdoor unit flexibly.

# 3,4-5 ROOMS NEOFLEXI



## A FULL PORTFOLIO TO MEET A WIDE RANGE OF NEEDS

For bedrooms that have higher demands in air quality and comfortable airflow, or living room that expect large-covered and even cooling, to home office that entails quiet environment and energy saving operation... all you can find solutions from the Midea product range.



Ceiling Concealed



Wall Mounted Split AC



Compact Cassette

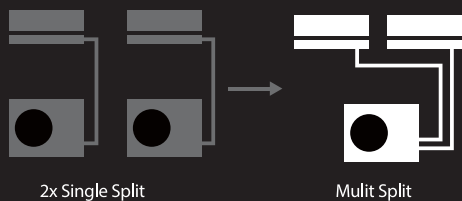

2x Single Split

Mult Split

### Space-saving Installation

Multiple indoor units can be connected to 1 outdoor unit, and long piping connection is also possible, which is especial friendly to small condos that have limited installation space and location.



### Individual Control

Individual freedom to operate the air conditioners with remote control, or at your fingertips with the MideaHOME smart control options. You can make your home environment ready to welcome you before you get home.



### App-based Remote Control

Based on the cloud service under M-Smart Security Protocol, the MideaAIR app makes your home life easier, smarter and more comfortable with versatile functions just in hand. Discover the MideaAIR to get your home life connected.



### Central Control

Batched control of up to 8 indoor units. The temperature, airflow volume, and the remote control prohibition settings of all indoor units can be batched.



# CENTRALIZED CONTROLLER



**CCM30**  
 Control up to 64 IDUs  
 Control 1 IDU independently  
 Control all IDUs synchronously



**CCM-180A/WS**  
 Control up to 64 IDUs  
 Control 1 IDU independently  
 Control all IDUs synchronously  
 Control by group

# WIRED CONTROLLER



**KJRC-12B**  
 Communication protocol: One-way communication (infrared)  
 Function: Standard functions, Follow me, Eco, LCD display, Timer On/Off



**120G**  
 Communication Protocol: Two-way communication (based on RS485/ non-polar dual cores)  
 Functions: Standard functions, Follow me, Constant AFV test (for duct), Weekly timer, Independent vane control (for cassette)



**120X**  
 Communication Protocol: Two-way communication (based on RS485/ non-polar dual cores)  
 Functions: Standard functions, Follow me, Constant AFV test (for duct), Weekly timer, Independent vane control (for cassette), Infrared receiving, Dual/centralized control, Rotation function, Touch button.

# OTHER KITS



**Smart Port**

- Wi-Fi control with smartphone or pad
- APP suitable for both Android and iOS system (NetHome Plus)
- All basic functions
- Senior functions such as weekly timer, customized sleep curve and self-check

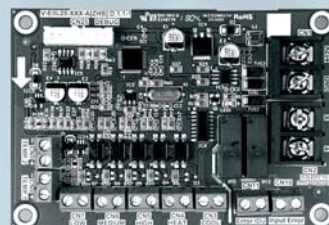

**24V Controller M24VIA**

- Specially designed for US Market
- 24V Thermostat support
- Support old DX indoor units match Midea inverter outdoor units
- Support current loop and 485 communication



**Portable Debugger for Inverter Only**

- For LCAC malfunction debugging and diagnosis
- Portable, compact and easy connecting to the unit

# SPECIFICATIONS

## MULTI SPLIT INDOOR

### Fairy Series Wall Mounted



Indoor model		MSAFBU-07HRFNX	MSAFBU-09HRFNX	MSAFBU-12HRFNX	MSAFBU-18HRFNX	MSAFBU-24HRFNX	
Power source	V/ph/Hz	220-240-/1/50	220-240-/1/50	220-240-/1/50	220-240-/1/50	220-240-/1/50	
Cooling capacity	Btu/h	7,000 (3,150-8,750)	9,000 (4,050-11,250)	12,000 (5,400-14,250)	18,000 (11,700-20,700)	24,000 (15,600-27,600)	
Power consumption - Rated	W	20	20	20	34	62	
Running current - Rated	A	0.09	0.09	0.09	0.15	0.28	
Indoor air flow (High)	m <sup>3</sup> /h (cfm)	520 (306)	520 (306)	600 (353)	840 (495)	980 (576)	
Indoor sound pressure level (Hi/Mi/Lo)	dB(A)	40/30/26	40/30/26	40/34/26	44/37/30	44.5/42/34.5	
Indoor unit	Dimension (WxDxH)	mm	805x194x285	805x194x285	805x194x285	957x215x302	1040x220x327
	Packing (WxDxH)	mm	870x270x360	870x270x360	870x270x360	1035x295x380	1120x405x310
	Net/Gross weight	Kg	7.5/9.7	7.5/9.7	7.5/9.7	10/13	12.3/15.8
	Liquid side/ Gas side	mm (inch)	Φ6.35(1/4")/Φ9.52(3/8")	Φ6.35(1/4")/Φ9.52(3/8")	Φ6.35(1/4")/Φ9.52(3/8")	Φ6.35(1/4")/Φ12.7(1/2")	Φ9.52(3/8")/Φ15.9(5/8")
Thermostat type		Remote Control					

# SPECIFICATIONS

## MULTI SPLIT INDOOR

### AE Pro Series Wall Mounted



Indoor model		MSEPB-U-09HRFN8	MSEPB-U-12HRFN8	MSEPCU-18HRFN8	MSEPDU-24HRFN8	
Power source	V/ph/Hz	220-240-/1/50	220-240-/1/50	220-240-/1/50	220-240-/1/50	
Cooling capacity	Btu/h	9,000 (4,050-11,250)	12,000 (5,400-14,250)	18,000 (11,700-20,700)	24,000 (15,600-27,600)	
Power consumption - Rated	W	20	20	30	58	
Running current - Rated	A	0.09	0.09	0.13	0.25	
Indoor air flow (High)	m <sup>3</sup> /h (cfm)	530 (312)	560 (329)	810 (476)	1092 (642)	
Indoor sound pressure level (Hi/Mi/Lo)	dB(A)	37/32/21.5	40/33/22	41/35/23	44.5/40/33	
Indoor unit	Dimension (WxDxH)	mm	795x225x295	795x225x295	965x239x319	1140x370x275
	Packing (WxDxH)	mm	870x370x305	870x370x305	1045x400x325	1230x455x355
	Net/Gross weight	Kg	10.2/13	10.2/13	12.3/16.4	20/25.3
	Liquid side/ Gas side	mm (inch)	Φ6.35(1/4")/Φ9.52(3/8")	Φ6.35(1/4")/Φ9.52(3/8")	Φ6.35(1/4")/Φ12.7(1/2")	Φ9.52(3/8")/Φ15.9(5/8")
Thermostat type		Remote Control				

# SPECIFICATIONS

## MULTI SPLIT INDOOR

### Compact Ceiling Cassette



Indoor model		MCA3U-07HRFNX	MCA3U-09HRFN8	MCA3U-12HRFNX	MCA3U-18HRFNX	
Power source	V/ph/Hz	220-240-/1/50	220-240-/1/50	220-240-/1/50	220-240-/1/50	
Cooling capacity	Btu/h	7,000 (4,150-8,350)	9,000 (4,650-11,250)	12,000 (5,500-14,250)	18,000 (12,100-21,000)	
Power consumption - Rated	W	40	40	40	102	
Running current - Rated	A	0.18	0.18	0.18	0.44	
Indoor air flow (High)	m <sup>3</sup> /h (cfm)	580 (341)	580 (341)	617 (363)	680 (400)	
Indoor sound pressure level (Hi/Mi/Lo)	dB(A)	38/33/29	38/33/29	41/37/34	44/42/41	
Indoor unit	Dimension (WxDxH)(body)	mm	570x570x260	570x570x260	570x570x260	570x570x260
	Packing (WxDxH)(body)	mm	662x662x317	662x662x317	662x662x317	662x662x317
	Dimension (WxDxH)(panel)	mm	647x647x50	647x647x50	647x647x50	647x647x50
	Packing (WxDxH)(panel)	mm	715x715x123	715x715x123	715x715x123	715x715x123
	Net/Gross weight (body)	Kg	14.5/17.3	14.5/17.3	16.2/21.4	16.2/21.4
	Net/Gross weight	mm (inch)	2.5/4.5	2.5/4.5	2.5/4.5	2.5/4.5
Design pressure	MPa	4.3/1.7	4.3/1.7	4.3/1.7	4.3/1.7	
Drainage water pipe dia.	mm	ODΦ25	ODΦ25	ODΦ25	ODΦ25	
Refrigerant piping	Liquid side/ Gas side	mm	Φ6.35/Φ9.52(1/4"/3/8")	Φ6.35/Φ9.52(1/4"/3/8")	Φ6.35/Φ9.52(1/4"/3/8")	Φ6.35/Φ12.7(1/4"/1/2")
Controller		Remote control				

Remarks: 1.The above design and specifications are subject to change without prior notice for product improvement.  
2.The values given in the table for the noise level reflect the levels in hemi-anechoic rooms.

# SPECIFICATIONS

## MULTI SPLIT INDOOR

### Ceiling Concealed



Indoor model			MTIU-07HWFNX	MTIU-09HWFNX	MTIU-12HWFNX	MTIU-18HWFNX
Power source	V/ph/Hz		220-240-/1/50	220-240-/1/50	220-240-/1/50	220-240-/1/50
Cooling capacity	Btu/h		7,000 (3,550-8,950)	9,000 (4,250-11,350)	12000 (5,800-14,550)	18000 (12,700-20,800)
Power consumption-Rated	W		170	180	185	200
Running current - Rated	A		1.0	1.1	1.1	1.3
Indoor air flow (High)	m <sup>3</sup> /h (cfm)		500 (294)	500 (294)	600 (353)	880 (518)
ESP	Rated	Pa	25	25	25	25
	Range	Pa	0-40	0-40	0-60	0-100
Indoor sound pressure level (Hi/Mi/Lo)	dB(A)		40/34.5/27.5	40/34.5/27.5	40/34.5/27.5	41.5/38/33
Indoor unit	Dimension (WxDxH)	mm	700x450x200	700x450x200	700x450x200	880x674x210
	Packing (WxDxH)	mm	860x540x275	860x540x275	860x540x275	1070x725x280
	Net/Gross weight	kg	18/22	18/22	18/22	24.3/29.6
Design pressure	MPa		4.3/1.7	4.3/1.7	4.3/1.7	4.3/1.7
Drainage water pipe dia.	mm		ØDØ25	ØDØ25	ØDØ25	ØDØ25
Refrigerant piping	Liquid side/ Gas side	mm (inch)	Φ6.35/Φ9.52(1/4"/3/8")	Φ6.35/Φ9.52(1/4"/3/8")	Φ6.35/Φ9.52(1/4"/3/8")	Φ6.35/Φ12.7(1/4"/1/2")
	Controller		Wired Control			

**Remarks:** 1.The above design and specifications are subject to change without prior notice for product improvement.  
2.The values given in the table for the noise level reflect the levels in hemi-anechoic rooms.

# SPECIFICATIONS

## MULTI SPLIT OUTDOOR



Outdoor model			M20H-14HFN8-Q	M20E-18HFN8-Q	M30G-21HFN8-Q	M30A-27HFN8-Q	M40E-28HFN8-Q	M40B-36HFN8-Q	M50E-42HFN8-Q
Power supply	V/ph/Hz		220-240-/1/50	220-240-/1/50	220-240-/1/50	220-240-/1/50	220-240-/1/50	220-240-/1/50	220-240-/1/50
Cooling capacity	Btu/h		14,000 (5,000-17,000)	18,000 (7,800-19,500)	21,000 (6,800-22,500)	27,000 (10,850-28,000)	28,000 (7,000-33,600)	36,000 (7,000-43,200)	42,000 (7,000-48,300)
Power consumption - Rated (Min.-Max.)	W		1,270 (115-1,672)	1,635 (690-2,000)	1,905 (180-2,200)	2,450 (290-3,100)	2,540 (890-3,180)	3,500 (1,290-4,240)	3,810 (280-4,650)
Running current - Rated (Min.-Max.)	A		5.8 (1.12-7.35)	7.3 (3.2-9.0)	8.3 (1.8-10)	11.2 (2.0-13.5)	11.3 (3.9-14.1)	16.8 (5.9-18.9)	16 (1.4-20.7)
Max. power consumption	W		2,750	3,050	3,910	4,100	4,150	4,600	4,700
Max. running current	A		12	12	17	18	19	21.5	22
Outdoor air flow	m <sup>3</sup> /h (cfm)		2100 (1235)	2100 (1235)	3000 (1765)	3000 (1765)	3800 (2235)	4000 (2352)	3850 (2265)
Outdoor sound pressure level	dB(A)		56	54	58	58	61.5	63	64
Throttle type			EEV	EXV+Capillary	EXV+Capillary	EXV+Capillary	EXV+Capillary	EXV+Capillary	EXV+Capillary
Outdoor unit	Dimension (WxDxH)	mm	805x330x554	805x330x554	890x342x673	890x342x673	946x410x810	946x410x810	946x410x810
	Packing (WxDxH)	mm	915x370x615	915x370x615	1030x438x750	1030x438x750	1090x500x875	1090x500x875	1090x500x875
	Net/Gross weight	kg	31.6/34.7	35/38	43.3/47.1	48/51.8	62.1/67.7	68.8/75.6	74.1/79.5
Refrigerant	Type		R32	R32	R32	R32	R32	R32	R32
	Charged quantity	kg	1.1	1.25	1.5	1.85	2.1	2.1	2.9
Design pressure	MPa		4.3/1.7	4.3/1.7	4.3/1.7	4.3/1.7	4.3/1.7	4.3/1.7	4.3/1.7
Refrigerant piping	Liquid side/ Gas side	mm (inch)	2x6.35mm(2x1/4")/ 2x9.52mm(2x3/8")	2x6.35mm(2x1/4")/ 2x9.52mm(2x3/8")	3x6.35mm(3x1/4")/ 3x9.52mm(3x3/8")	3x6.35mm(3x1/4")/ 3x9.52mm(3x3/8")	4 x 6.35mm/3x 9.52mm +1x12.7mm (4x1/4"/3x3/8"+1x1/2")	4 x 6.35mm/3x9.52mm +1x12.7mm (4x1/4"/3x3/8"+1x1/2")	5 x 6.35mm/4x 9.52mm + 1x12.7mm (5x1/4"/4x3/8"+1x1/2")
	Max. length for all rooms	m	40	40	60	60	80	80	80
	Max. length for one indoor unit	m	25	25	30	30	35	35	35
	Max. height difference between indoor and outdoor unit	m	15	15	15	15	15	15	15
	Max. height difference between indoor units	m	10	10	10	10	10	10	10

**Remarks:** 1.The above design and specifications are subject to change without prior notice for product improvement.  
2.The values given in the table for the noise level reflect the levels in hemi-anechoic rooms.



# COMBINATION

## MULTI-SPLIT R32 MODEL

### M2OC-18HFN8- Q

One Unit	Two Unit
9	9+9
12	9+12
18	

### M3OE-21HFN1- Q

One Unit	Two Unit		Three Unit		
7	7+7	9+9	12+12	7+7+7	7+9+9
9	7+9	9+12		7+7+9	9+9+9
12	7+12	9+18		7+7+12	
18	7+18				

### M3OE-27HFN8- Q

One Unit	Two Unit		Three Unit
9	9+9	12+12	9+9+9
12	9+12	12+18	9+9+12
18	9+18		9+12+12

### M4OB-36HFN8- Q

One Unit	Two Unit		Three Unit			Four Unit	
9	9+9	12+12	9+9+9	9+12+12	12+12+12	9+9+9+9	9+9+12+12
12	9+12	12+18	9+9+12	9+12+18	12+12+18	9+9+9+12	9+12+12+12
18	9+18		9+9+18	9+12+24		9+9+9+18	
24			9+9+24	19+18+18			

### M5OB-42HFN8-Q

One Unit	Two Unit		Three Unit			Four Unit		
9	9+9	12+12	9+9+9	9+12+12	12+12+12	9+9+9+9	9+9+12+12	9+12+12+18
12	9+12	12+18	9+9+12	9+12+18	12+12+18	9+9+9+12	9+9+12+18	12+12+12+12
18	9+18	12+24	9+9+18	9+12+24	12+12+24	9+9+9+18	9+9+12+24	12+12+12+18
24	9+24	18+18	9+9+24	19+18+18	12+18+18	9+9+9+24	9+12+12+12	
Five Unit								
9+9+9+9+9			9+9+9+12+12					
9+9+9+9+12			9+9+12+12+12					
9+9+9+9+18								