

***αLPHα***

# **Instruction Manual**

**CEILING FAN MODEL : VILLA**

# Tables of Contents

Item	Page No.
1. Safety Precautions .....	1
2. Parts & Accessories .....	2
3. Installation Instruction.....	3
a. Accessories assembly .....	3
b. Fan mounting .....	4
b. Wiring & receiver connection .....	5
c. Blades assembly .....	6
d. Light kit assembly .....	8 - 9
4. Transmitter Operation .....	10 - 11
5. Maintenance .....	12
6. Technical Specifications .....	12 - 13
7. Customer Service Centre .....	13

## Safety Precaution

### **IMPORTANT : PLEASE READ BEFORE INSTALLATION.**

1. Installation must be carried out by a qualified wiring installer.
2. Turn off the electrical mains at the circuit breaker fuse box.
3. Do not use power supply other than 240V 50Hz.
4. This appliance must be earthed.
5. When mounting the fan, ensure that the safety wire is loop across the ceiling mounting hook.
6. The ceiling mounting hook must be able to withhold a min. weight of 35 pounds.
7. The ceiling fan must be mounted at a min. height of 8.2 feet / 2.5 m of clearance from the floor.
8. Do not place any objects in the path of the blades.
9. When all electrical connections are done, store all wires neatly.
10. Make sure that all screws and connection are tightly screwed and secured.

## Warning



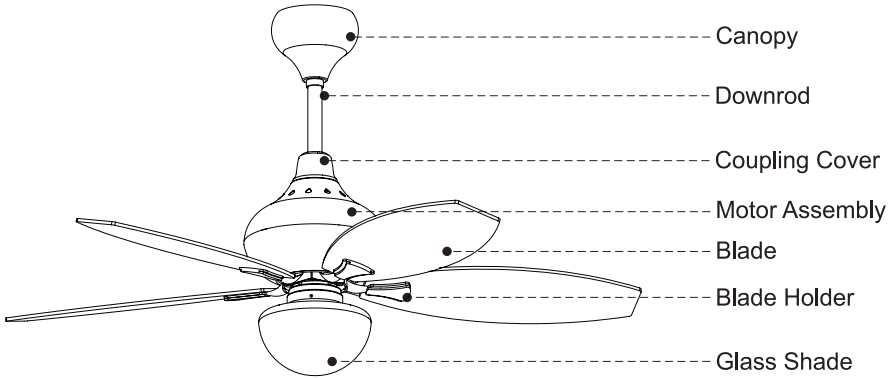

This product is designed to use only those parts supplied with this product and/or accessories designated specifically for use with this product. Using parts and/or accessories not designated for use with this product could result in personal injury or property damage.

# Parts & Accessories

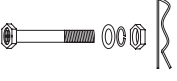

Item	Qty
1. Canopy	1
2. Downrod Assembly with Rubber Pulley	1
3. Coupling Cover	1
4. Motor Assembly	1
5. Blade	5
6. Blade Holder	5
7. Glass Shade	1
10. Assembly Kit	1
11. Balancing Kit	1



## Assembly Kit

			
Bolt x 1	Blade Screw x 16	Blade Holder Screw x 1	Wire Connector x 3

## Balancing Kit

	
Balancing Clip x 1	Balancing Metal x 2

## Receiver & Transmitter Kit

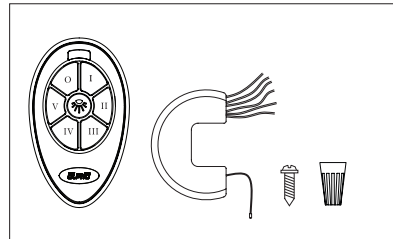

## Note :

The illustrations in this manual are for explanation purposes only and may differ from the actual unit. It is subjected to change without prior notice for further improvements.

# Accessories Assembly

**IMPORTANT : SWITCH OFF THE ELECTRICAL MAINS AT THE CIRCUIT BREAKER FUSE BOX.**

**Step 1** - Assemble the canopy and coupling cover through the downrod.

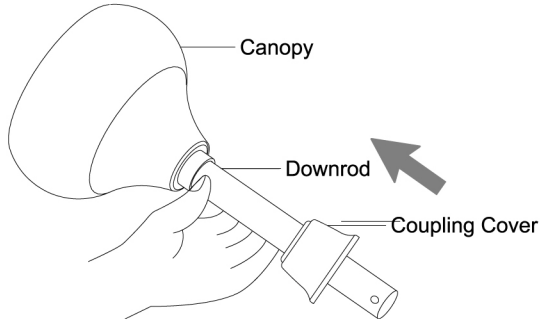

**Step 2** - Route all the wires from the motor through the downrod. Fix the downrod to the shaft with bolt, washer, nut and tighten them firmly then insert the clevis pin.

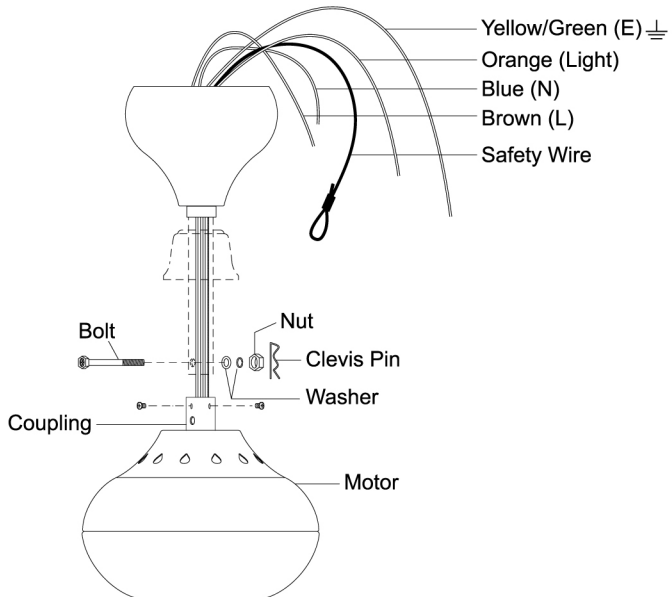

# Fan Mounting

**Step 3** - Remove the bolt, clevis, nut, washer and rubber pulley from the downrod. Place the rubber pulley onto the ceiling hook and fix back the bolt, clevis, nut and washer .

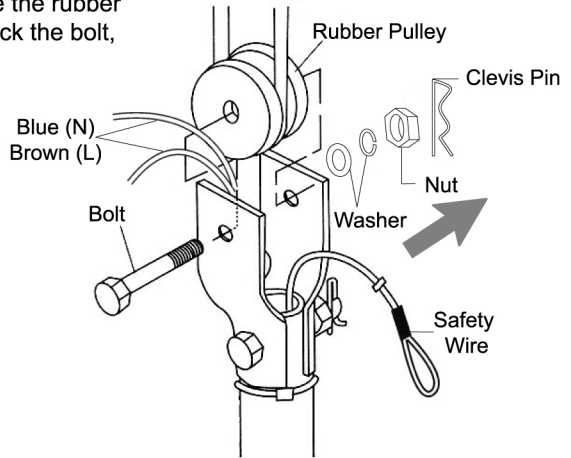

**Step 4** - Tie the safety wire across the hook and insert into the bolt and secure with washer, nut and clevis pin.

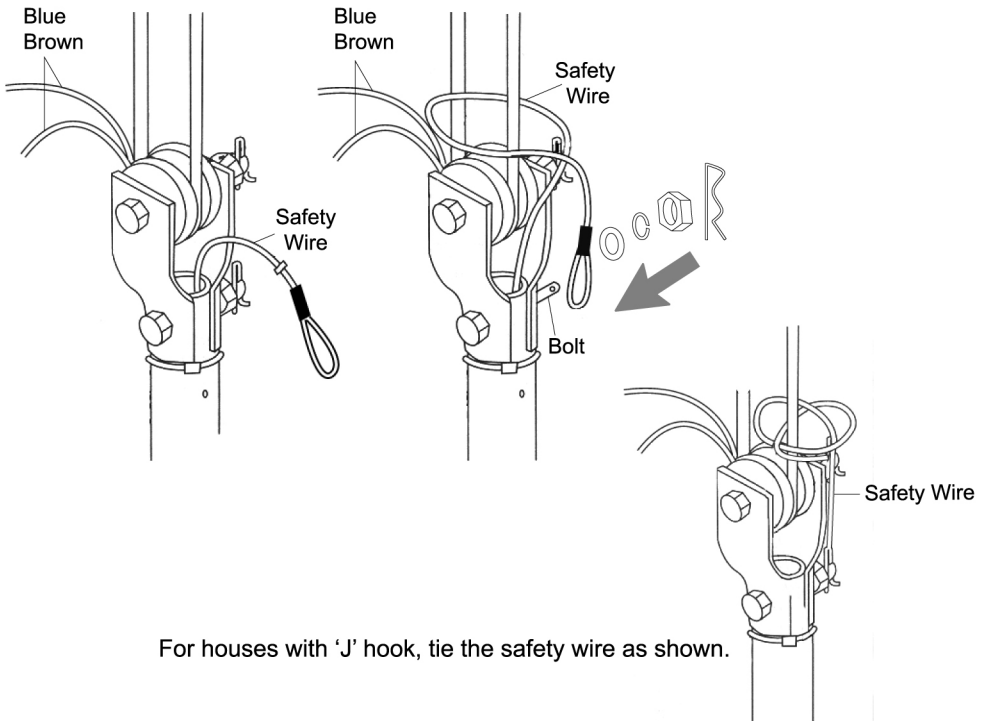

For houses with 'J' hook, tie the safety wire as shown.

# Wiring & Receiver Connection

**IMPORTANT : SWITCH OFF THE ELECTRICAL MAINS AT THE CIRCUIT BREAKER FUSE BOX.**

**Step 5** - Connect the brown, blue and orange wires from the receiver to the fan. Connect the red, white and green wires to the house's supply wire.

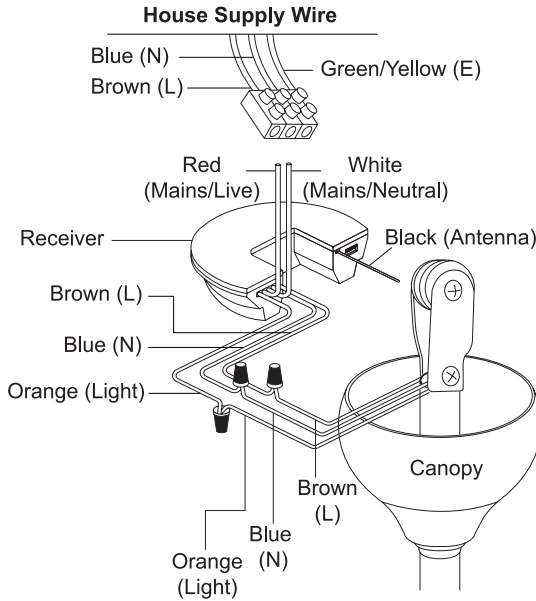

**Step 6** - Match the codes on the receiver and transmitter to be at the same mode. To change the code, push the code switch up or down. Insert the receiver into the canopy and store all wires neatly.

**To control 2 or more fans using 1 transmitter, set all receiver's code at the same mode with the transmitter.**

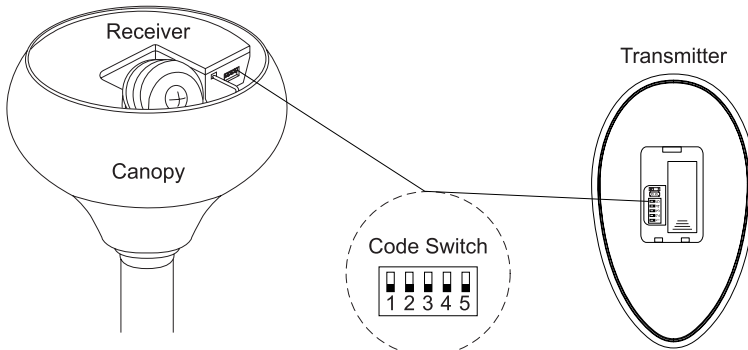

# Blades Assembly

**Step 7** - Align the 3 holes on the blade holder and blade and screw on with the screws and washers provided.

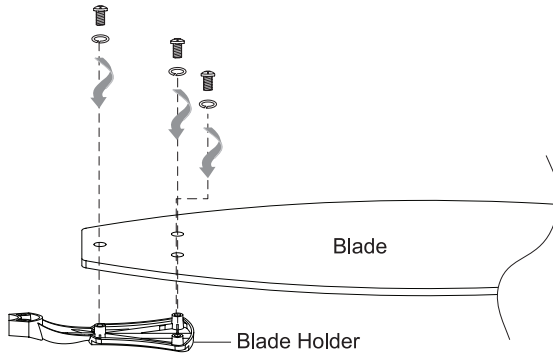

**Step 8** - Remove the screws at the motor and fix the blade holder to the motor using these screws.

**Important :** Assemble the blades only after the ceiling fan is mounted on the hook.

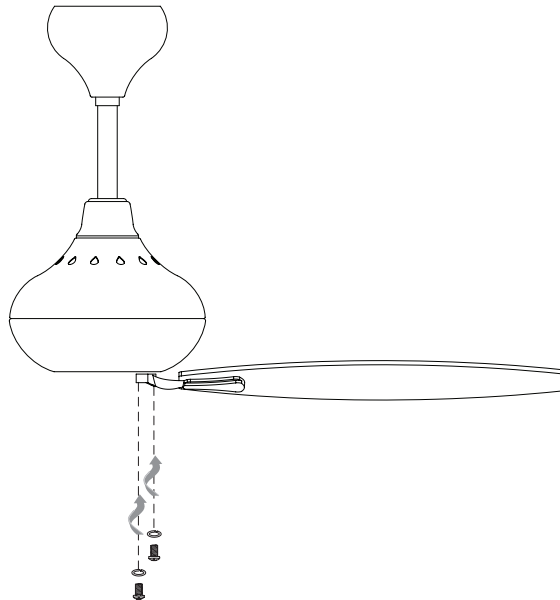

# Accessories Assembly

THE BELOW STEP SHOWS MODEL WITHOUT LIGHT KIT

Install the decorative screw to the fan.

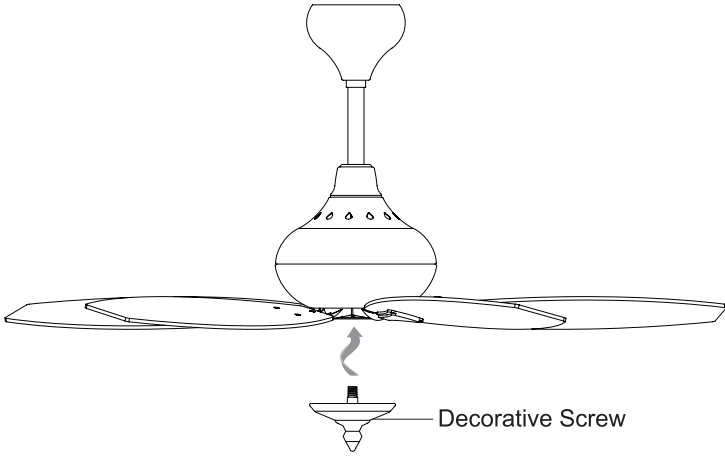

The diagram below shows a complete installation

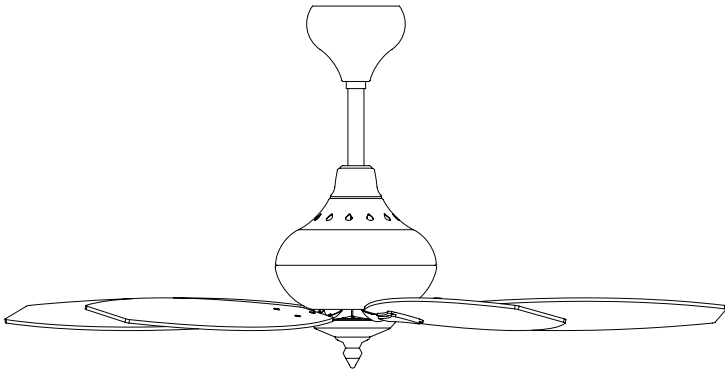



# Light Kit Assembly

## THE BELOW STEPS SHOW MODEL WITH LIGHT KIT

Remove the screws at the switch housing and connect the light kit wire and fix the socket plate to the switch housing using these screws.

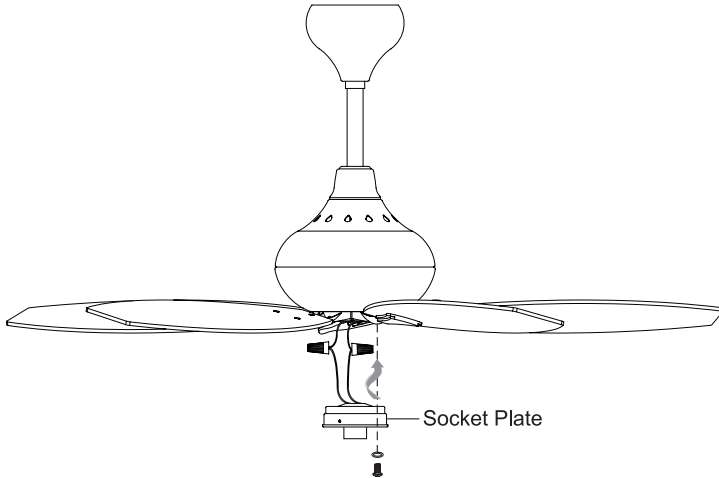

1. Remove the 3 screws on the socket plate. Install the bulb E27, Max 25W (not included).
2. Install the glass shade to the socket plate and secure with the 3 screws removed earlier.

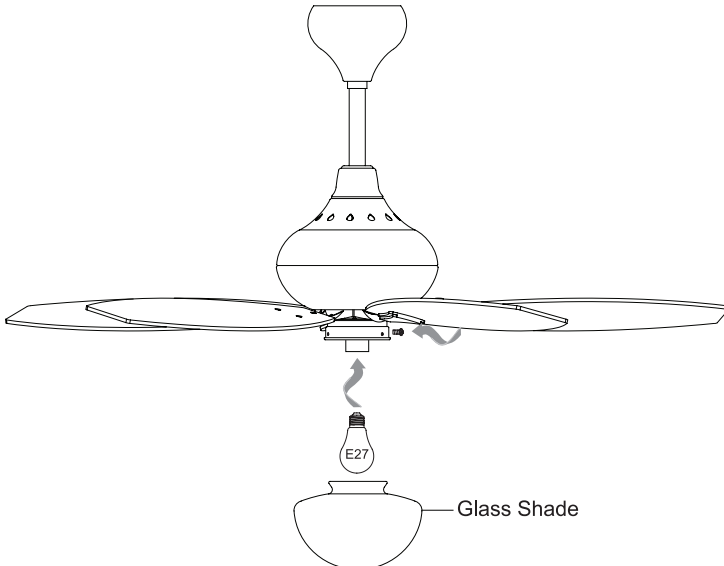

# Light Kit Assembly

The diagram below shows a complete installation

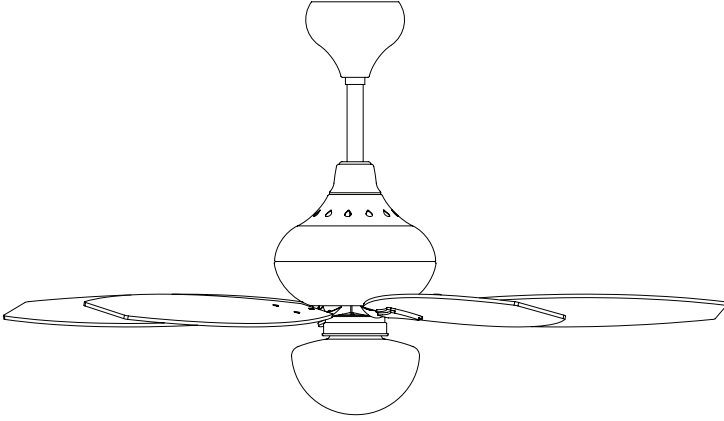

# Transmitter Operation

**IMPORTANT : DO NOT CONNECT THIS REMOTE CONTROL CEILING FAN TO DIMMER SWITCH OR WALL REGULATOR.**

Insert the 12V battery (provided) into the transmitter.

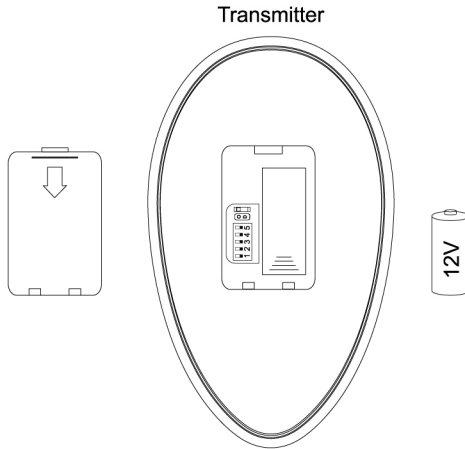

Set the switch on the transmitter according to the type of bulb using.  
**Important : Incorrect setting may cause the fan to malfunction.**

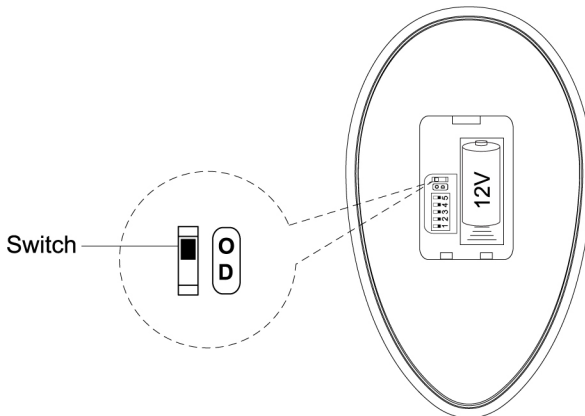

**For energy saving bulb, push the switch to “O” position**  
**For incandescent / tungsten bulb, push the switch to “D” position**

# Transmitter Operation

- I - Speed 1
  - II - Speed 2
  - III - Speed 3
  - IV - Speed 4
  - V - Speed 5
  - O - Turn off the fan
-  - 1. Press once to switch on/off light  
2. Press and hold on to dim the light to desire brightness

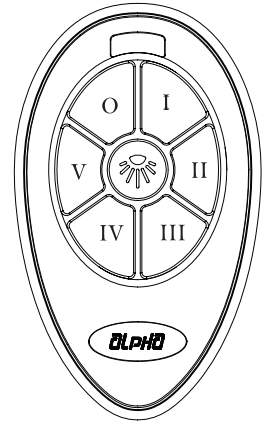

**Note :** To use the dimmer function, you must use incandescent / tungsten bulb and set the switch behind the transmitter at “D” position.  
(Ref to 2<sup>nd</sup> diagram on page 10)

Mount the transmitter holder on the wall with the screws provided.

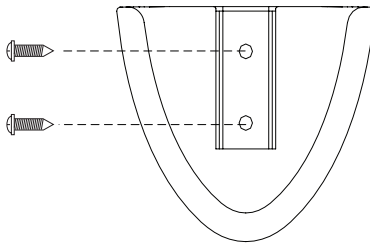

# Maintenance

**IMPORTANT : SWITCH OFF THE ELECTRICAL MAINS AT THE CIRCUIT BREAKER FUSE BOX.**

Due to the fan's natural movement, connections may get loose after a period of usage. To ensure a proper and safety usage, inspect the suspension system yearly and tighten all connections every 6 months.

## Cleaning

Cleaning your fan periodically will prolong its new appearance. Basic cleaning procedures are as follows :

1. Use only lukewarm water. Do not use detegent, corrosive or acidic solution.
2. Damp the cloth lightly. Use only soft or lint-free cloth to clean the fan. Rough fabric will scratch the surface.
3. To cover small scratches, apply a light coat of shoe polish over it.
4. There is no need to lubricate the fan.

# Technical Specification

Model	Villa
No. of blades	5
Fan width	40"
Motor RPM	105 - 275
Voltage	240V 50Hz
Wattage	15W - 65W

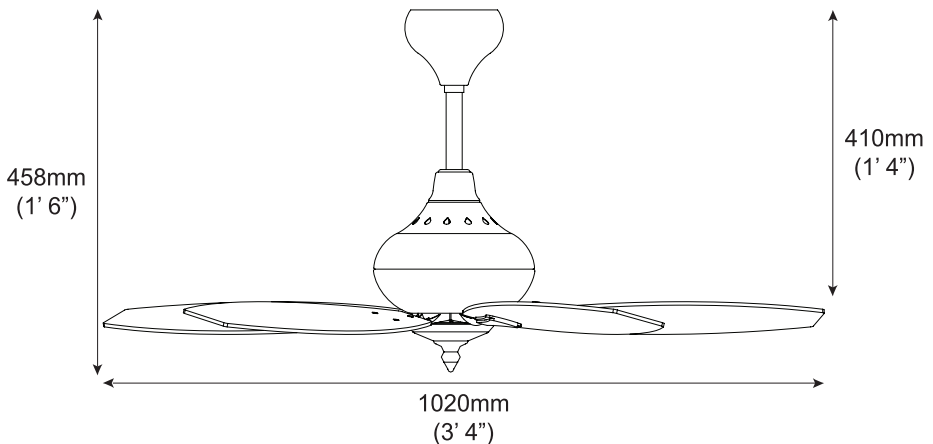

# Technical Specification

