

ALPHA

Instruction Manual

CEILING FAN MODEL : 719/3B & 719/5B

Table of Contents

Item	Page No.
1. Safety Precautions	1
2. Parts & Accessories	2
3. Installation Instruction.....	3
a. Fan mounting	3 - 5
b. Wiring connection.....	6
c. Blades assembly	6 - 7
d. Transmitter assembly & operation	7 - 8
4. Power Supply Connection	8 - 9
5. Circuit Diagram	10
5. Maintenance	10
6. Technical Specifications	10 - 11
7. Customer Service Centre	11

Safety Precaution

IMPORTANT : PLEASE READ BEFORE INSTALLATION

1. Installation must be carried out by a qualified wiring installer.
2. Turn off the electrical mains at the circuit breaker fuse box.
3. Do not use power supply other than 240V 50Hz.
4. The appliance must be permanently connected to the electricity supply through a double pole switch having a contact separation of at least 3mm in all poles.
5. Do not connect ceiling fan to any dimmer switch or regulator.
6. When mounting the fan, ensure that the safety wire is loop across the ceiling mounting hook.
7. The ceiling mounting hook must be able to withhold a min. of 35 pounds.
8. The ceiling fan must be mounted at a min. height of 8.2 feet / 2.5m of clearance from the floor and 3 feet / 1m from the wall to the blade.
9. Do not install at areas/places near/at
 - a) chemicals and alkali
 - b) flammable area such as gas cooker
 - c) oily places
 - d) wet and high humidity area such as shower room
 - e) high vibration/impact and continuously expose to direct wind
10. Do not place any objects in the path of the blades.
11. When all electrical connections are done, store all wires neatly.
12. Make sure that all screws and connection are tighten till snug.

Warning



This product is designed to use only those parts supplied with this product and/or accessories designated specifically for use with this product. Using parts and/or accessories not designated for use with this product could result in personal injury or property damage.

Parts & Accessories - 719/3B & 719/5B

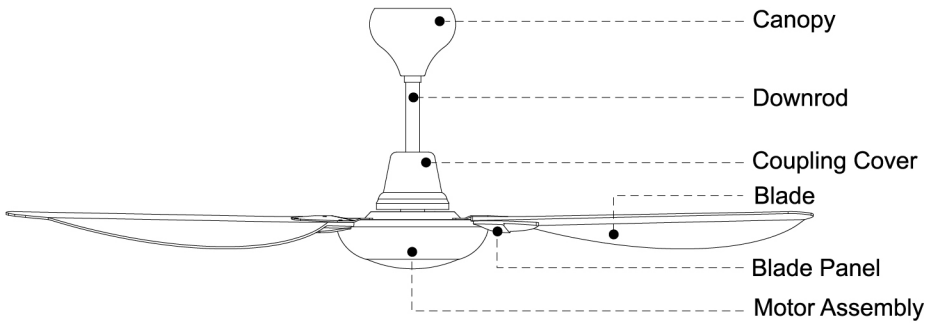
Item	Qty
1. Canopy	1
2. Downrod Assembly with Rubber Pulley	1
3. Coupling Cover	1
4. Motor Assembly	1
5. Blade - 719/3B	3
Blade - 719/5B	5
6. Blade Panel - 719/3B	3
Blade Panel - 719/5B	5
7. Motor Assembly	1
8. Assembly Kit	1

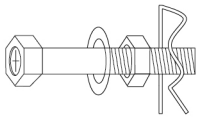

Assembly Kit

		
Bolt x 1	Blade Panel Screw x 10	Blade Holder Screw x 1

Note :

The illustrations in this manual are for explanation purposes only and may differ from the actual unit. It is subjected to change without prior notice for further improvements.

Installation Instruction

IMPORTANT : SWITCH OFF THE ELECTRICAL MAINS AT THE CIRCUIT BREAKER FUSE BOX.

Step 1 - Assemble the canopy and coupling cover through the downrod.

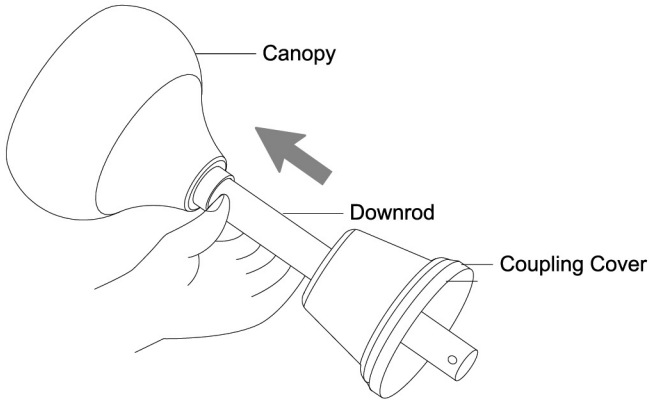

Step 2 - Route the all the wires from the motor through the downrod. Fix the downrod to the coupling with bolt, washer, nut and tighten them firmly then insert the clevis pin.

IMPORTANT : Clevis pin MUST be inserted to prevent nut from loosening.

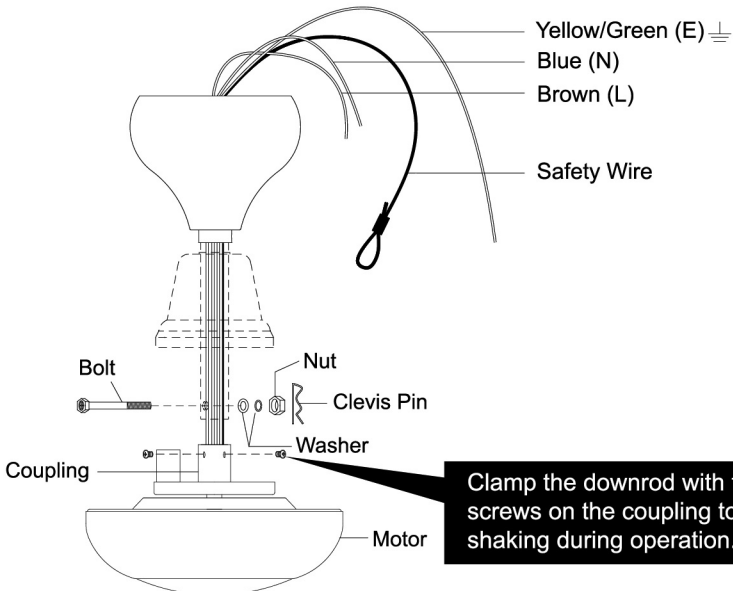

Installation Instruction

Step 3 - Remove the bolt, clevis, nut, washer and rubber pulley from the downrod.
Place the rubber pulley onto the ceiling hook and fix back the bolt, clevis, nut and washer.
IMPORTANT : Clevis pin **MUST** be inserted to prevent nut from loosening.

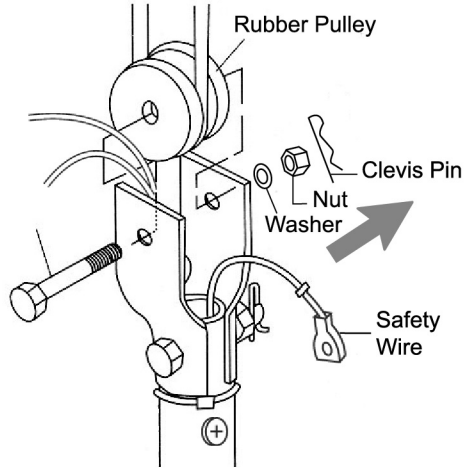

Step 4 - Remove the safety wire screw and spring washer from the downrod.
IMPORTANT : Clevis pin **MUST** be inserted to prevent nut from loosening.

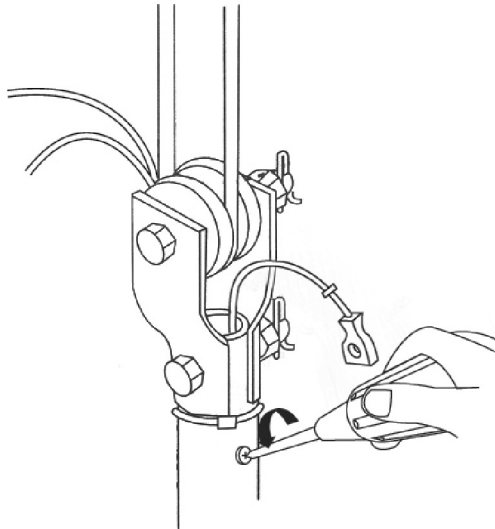

Installation Instruction

Step 5 - Tie the safety wire across the hook as shown.

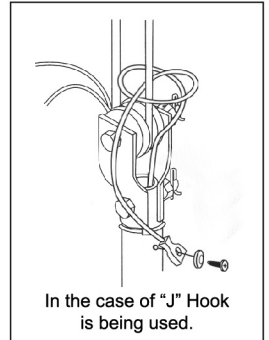
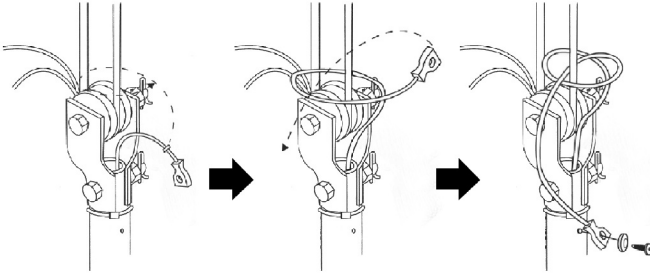

Step 6 - Firmly screw the safety wire with spring washer onto the downrod.

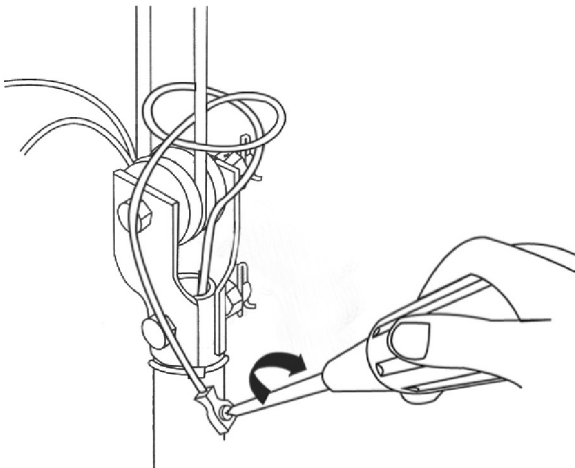

Installation Instruction

Step 7 - Connect the brown, blue and orange wires from the receiver to the fan. Connect the red, white and green wires to the house's supply wire.

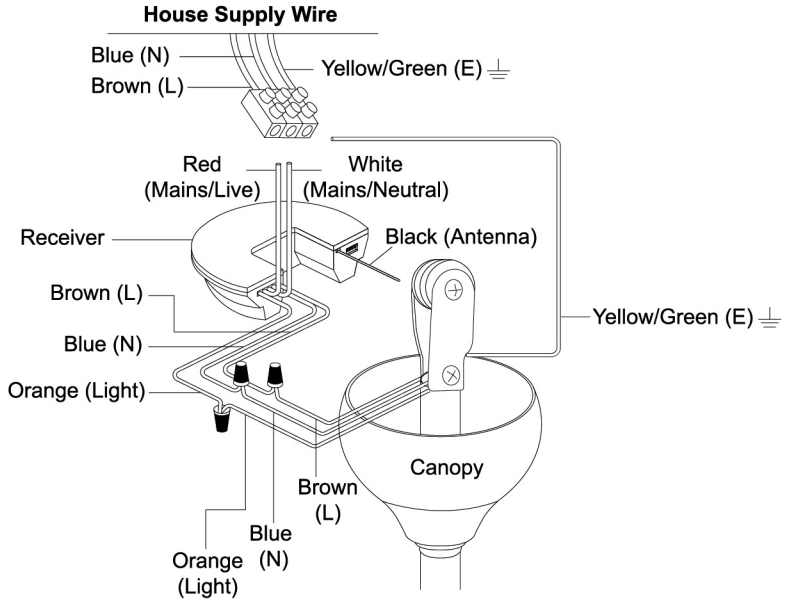

Step 8 - Align the 3 holes on the blade holder, blade and blade panel and screw on with the screws and washers provided.

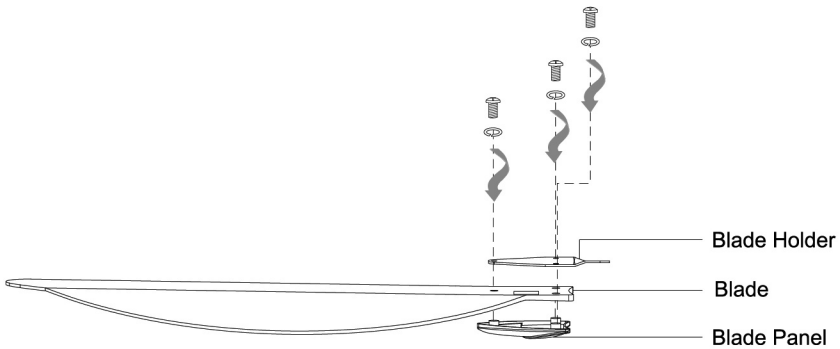

Installation Instruction

Step 9 - Remove the screws at the motor and fix the blade to the motor using these screws.

IMPORTANT : Assemble the blades only after the ceiling fan is mounted on the hook.

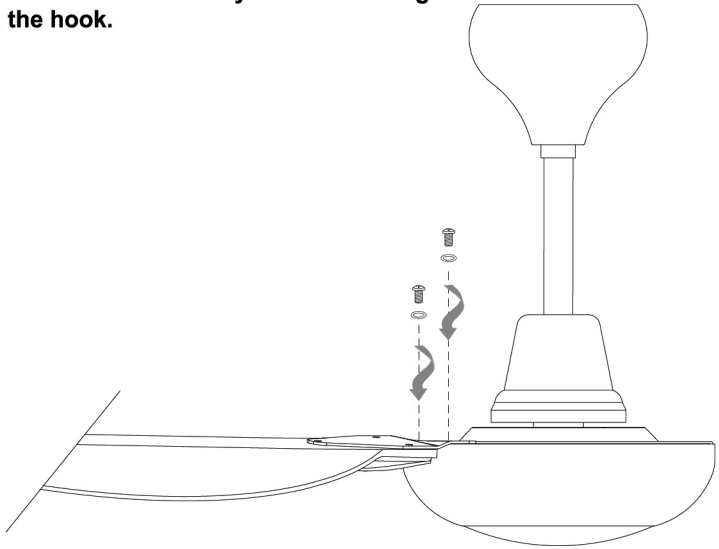

Transmitter Assembly & Operation

Insert the 9V battery (provided) into the transmitter.

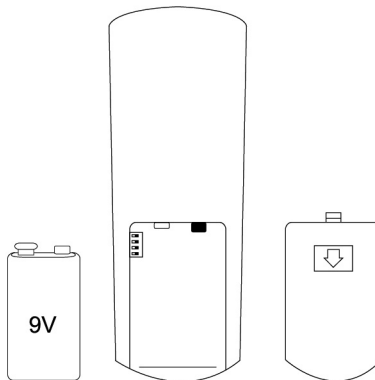

Transmitter Assembly & Operation

Function of Transmitter

- OFF - Turns off the fan
- 1 - Low speed
- 2 - Medium speed
- 3 - High speed
- 4 - Highest speed
- ON - Turn on light kit (if any)
- OFF - Turn off light kit (if any)



Mount the remote control holder on the wall with screws provided.

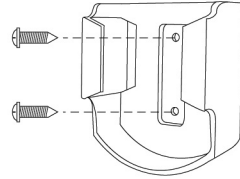

Power Supply Connection

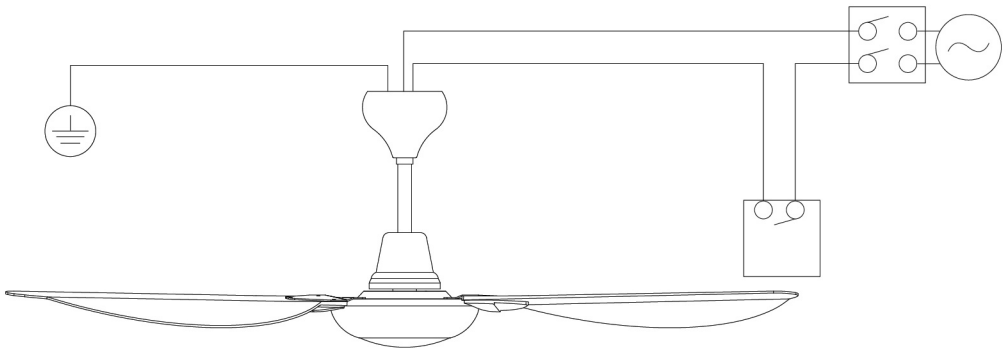

Power Supply Connection

IMPORTANT : DO NOT CONNECT THIS REMOTE CONTROL CEILING FAN TO REGULATOR OR DIMMER SWITCH.

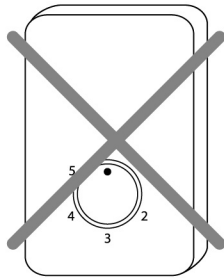

Regulator

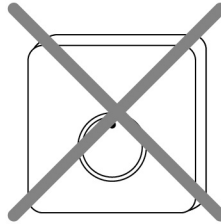

Dimmer Switch

Circuit Diagram

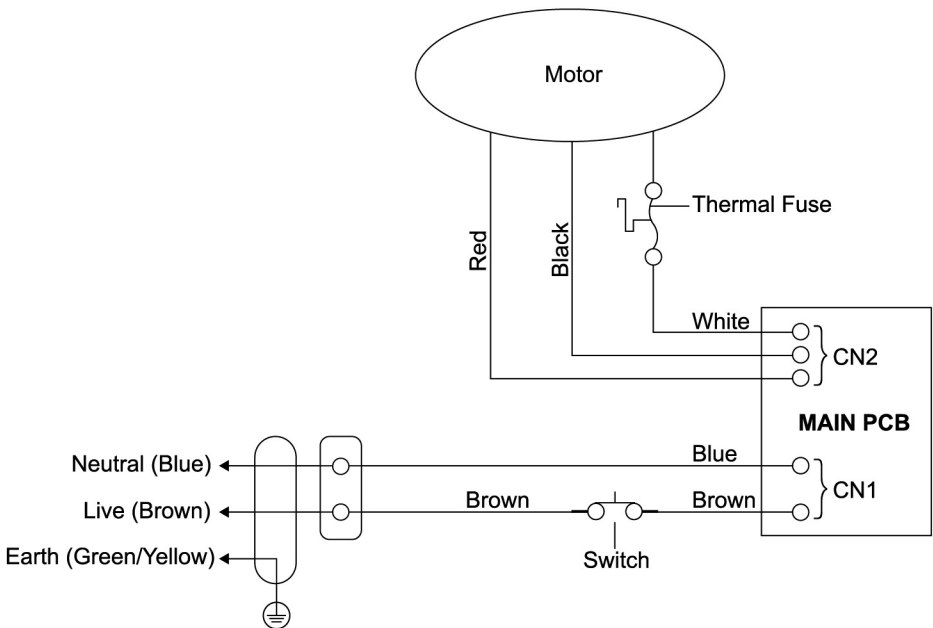

Maintenance

Due to the fan's natural movement, connections may get loose after a period of usage. To ensure a proper and safety usage, it is highly recommended to inspect and tighten all connections every 6 months.

Cleaning

Cleaning your fan periodically will prolong its new appearance. Basic cleaning procedures are as follows :

1. Use only water and mild soap. Do not use solvents, corrosive or acidic solution.
2. Damp the cloth lightly. Use only soft or lint-free cloth to clean the fan. Rough fabric will scratch the surface.
3. Do not bent the blades while cleaning. At the event where blades are bent or damage, order new set of blades from service center or dealer shop.
4. There is no need to oil the fan.

Technical Specifications

Model	719/5B	719/3B
No. of blades	5	3
Fan width	56"	
Motor RPM	70 - 200	100 - 200
Voltage	240V 50Hz	
Wattage	25W - 90W	30W - 90W

Technical Specifications

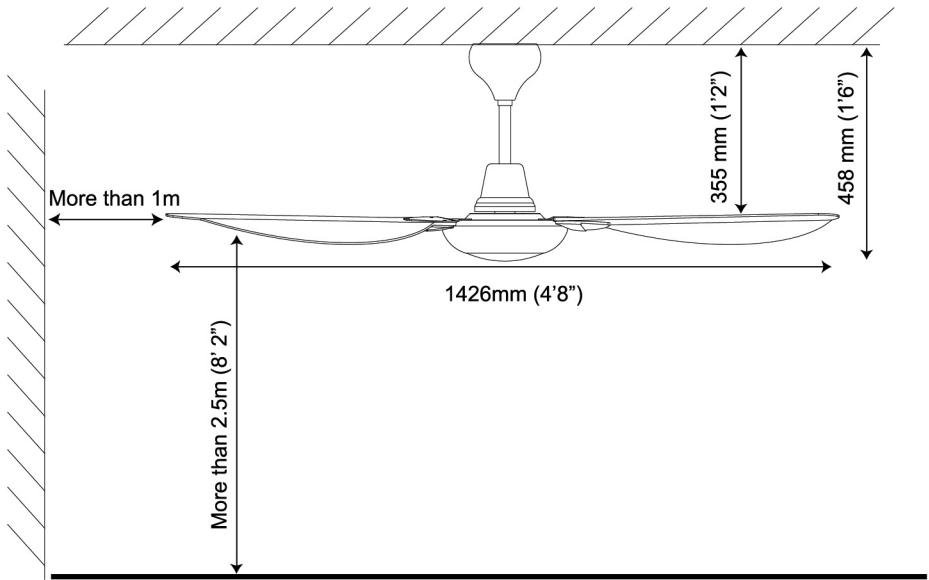

Customer Service Centre

If you need any technical assistance or faulty report, please contact our customer service centre at :

Alpha Home Appliances Sdn. Bhd. (390258-H)

Head Office : 6, Jalan Sungai Kayu Ara 32/37, Berjaya Park, Sect 32,
40460 Shah Alam, Selangor.

Tel : 03-5740 6666

Fax : 03-5740 8220

Website : www.alphamalaysia.com

Email : info@alphamalaysia.com

Johor Bahru : 71, Jalan Molek 3/10, Taman Molek, 81100 Johor Bahru.

Tel : 07-353 4833 / 4933

Fax : 07-355 4233

Melaka : G-8, Jalan PM3, Plaza Mahkota, 75000 Melaka.

Tel : 06-292 2398 / 2399

Fax : 06-292 2392

Ipoh : 16, Jalan Tasek Timur, Taman Tasek Indra, 31400 Ipoh, Perak.

Tel : 05-545 2282 / 547 2282

Fax : 05-547 6282

Penang : 2744, Ground Floor, Jalan Chain Ferry, Taman Inderawasih, 13600 Prai.

Tel : 04-397 9923 / 9920

Fax : 04-397 9690

Pahang : A131, TK1, Jalan Wang Ah Jang, Taman Lisa, 25100 Kuantan, Pahang.

Tel : 09-516 5226

Fax : 09-513 9226