

***ALPHA***

# instruction manual

**CEILING FAN**



*For model : CF 318/5B*

# Parts & Accessories

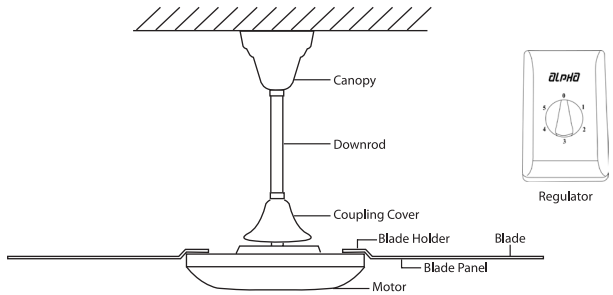

Item	Qty
1. Motor Assembly	1
2. Canopy	1
3. Coupling Cover	1
4. Blades	5
5. Blade Holder	5
6. Blade Panel	5
7. Downrod Assembly	1
8. Regulator	1
9. Screw Pack	1
10. Balancing Kit	1



## Screw Pack List

		
Blade Screw x 17	Wire Connector x 2	Bolt x 1

## Balancing Kit List

	
Balancing Clip x 1	Balancing Metal x 2

## Safety Precaution

### IMPORTANT : PLEASE READ BEFORE INSTALLATION

1. Installation must be carried out by a qualified wiring installer and according to this instruction manual.
2. Turn off the electrical mains at the circuit breaker fuse box.
3. Do not use power supply other than 240V 50Hz.
4. When mounting the fan, the safety wire must loop across the ceiling mounting hook.
5. Ceiling mounting hook must be able to withhold a min. of 16 kg.
6. Ceiling fan must be mounted at a min. height of 8.2ft / 2.5m of clearance from the floor.
7. Do not place any objects in the path of the blades.
8. When all electrical connections are done, store all wires neatly.
9. Make sure that all screws and connection are tightly screwed and secured.

## Installation Instruction - Fan Mounting

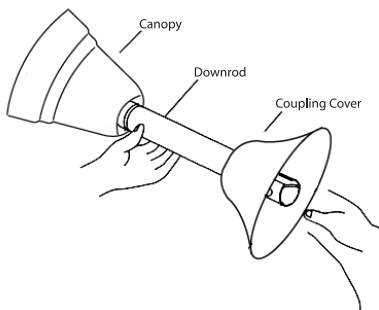

**Step 1** - Remove the clevis pin, nut and bolt on the downrod. Insert canopy follow by coupling cover.

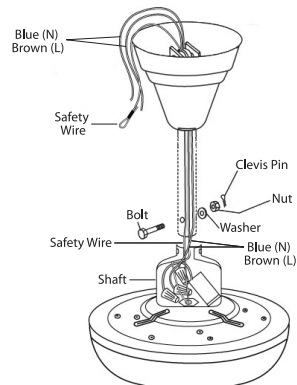

**Step 2** - Route the safety wire, blue and brown wires through the downrod. Fix the downrod to the shaft with bolt & nut and tightened them firmly then insert t clevis pin.

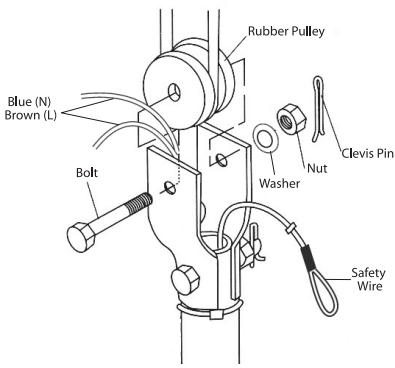

**Step 3** - Remove the bolt and rubber pulley from the downrod and place it into the ceiling mounting hook.

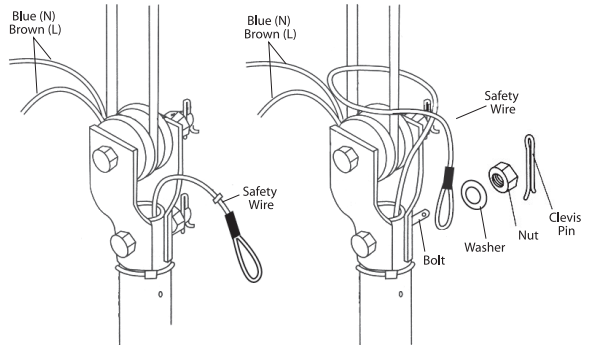

**Step 4** - Tie the safety wire across the hook and insert into the bolt and secure with washer, nut and clevis pin.

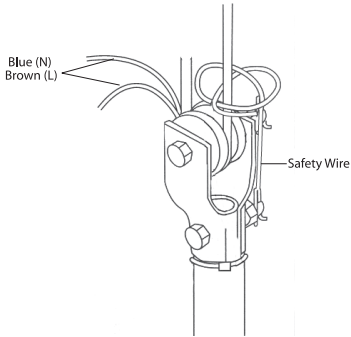

For houses with 'J' hook - Tie the safety wire as shown.

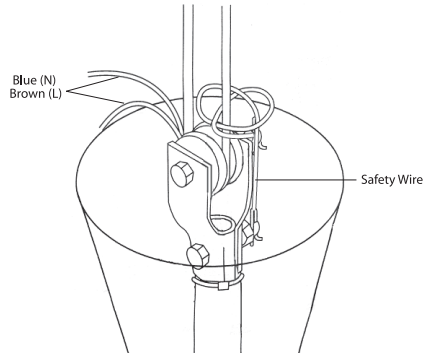

**Step 5** - Connect the blue & brown wire to the house's supply wire. Diagram shows a complete assembly of the ceiling fan with safety wire mounted on the hook.

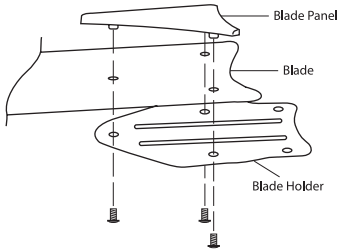

**Step 6** - Align the 3 holes on the blade panel, blade and blade holder and screw on with the screws provided.

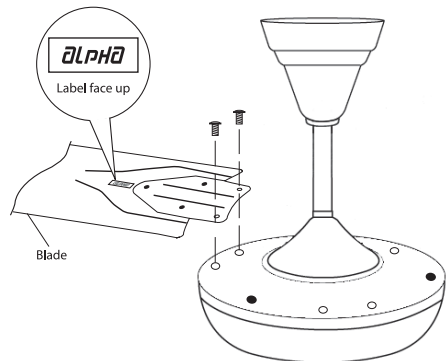

**Step 7** - Remove the screws at the motor and fix the blade to the motor using these screws.

**Important : Assemble the blades only after the ceiling fan is mounted on the hook.**

# Regulator and Wiring Installation Instruction

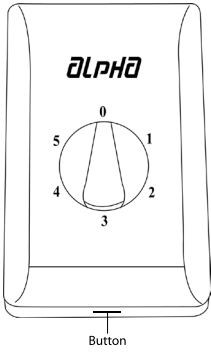

Step 1 - Remove the regulator cover using a test pen and push the button.

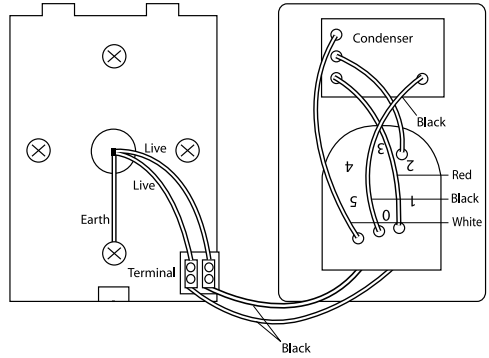

Step 2 - Connect the live & earth wire from the house supply to the terminal.

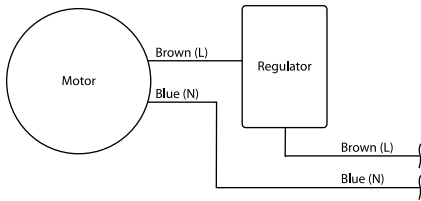

Connection Diagram

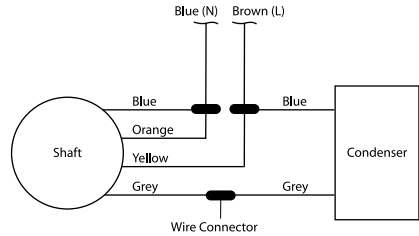

Top View of Motor Terminal

## Technical Specifications

- Model : CF 318/5B
- No. of blades : 5
- Fan Width : 40"
- Voltage : 240V / 50Hz
- Wattage : 20-80W

*Specification are subjected to change without prior notice for further improvement.*



- Width : 82 mm
- Height : 122 mm
- Depth : 50 mm

