



PROGRAMMABLE CONTROLLER

FP PROGRAMMER II

Operation Manual

BEFORE BEGINNING

This manual and everything described in it are copyrighted. You may not copy this manual, in whole or part, without written consent of Matsushita Electric Works, Ltd.

Matsushita Electric Works, Ltd. pursues a policy of continuous improvement of the design and performance of its product, therefore, we reserve the right to change the manual/product without notice. In no event will Matsushita Electric Works, Ltd. be liable for direct, indirect, special, incidental, or consequential damage resulting from any defect in the product or its documentation, even if advised of the possibility of such damages.

LIMITED WARRANTY

All implied warranties on the product, including merchantability and fitness, are limited to one year from the date of purchase.

If physical defects caused by distribution are found, Matsushita Electric Works, Ltd. will replace/repair the product free of charge. Exceptions include

- When physical defects are due to a different usage/treatment of the product than described in the manual.
- When physical defects are due to defective equipment other than the distributed product.
- When physical defects are due to modification/repair by someone other than Matsushita Electric Works, Ltd.
- When physical defects are due to natural disasters.

Introduction

The FP Programmer II is a handy type of programming tool for FP series programmable controllers FP1, FP3, FP5, FP10S, FP10, FP-C and FP-M.

With the FP Programmer II, you can enter, change, insert, and delete instructions written in the internal RAM of the programmable controller (CPU). With the key operations on the FP Programmer II, you can easily edit the program.

It also provides so called “OP Functions” with which you can monitor or change ON/OFF status of relays or register values stored in the programmable controller, or set system register parameters.

The FP Programmer II can be used as a program carrier. You can upload a program from the NPST-GR, an FP series programming software, or a programmable controller and store it temporarily in the FP Programmer II. Then you can download it to the NPST-GR or programmable controller. This function may be convenient for you to carry program when you cannot easily connect your computer with the programmable controller because of ventilation.

This manual explains how to use the FP Programmer II. Chapter 1 overviews the FP Programmer II and explains how to connect it with the programmable controller. Before operating FP Programmer II, read this chapter to understand the keys on the FP Programmer II. Chapter, 2, 3 and 4 explains how to edit the program. Chapter 5 explains about OP Functions, and Chapter 6 are about the program carrier function.

For details of program instructions, system register assignments, relay and register numbers, refer to appropriate manual such as, the programming manual, hardware manual, and others.

CONTENTS

BEFORE BEGINNING LIMITED WARRANTY

Introduction	
Contents	
What's in each Chapter	
Outline	
Notation used in this manual	
Abbreviations used in this manual	

CHAPTER 1: BEFORE OPERATING FP PROGRAMMER II

1.1 What You Can Do with the FP Programmer II.....	2
1.2 Part Names.....	3
1.3 Operation Keys.....	4
1.4 Setting-up the FP Programmer II.....	7
Communication Parameters.....	7
Preparing a Cable	8
Connecting the FP Programmer II with the Programmable Controller	8

CHAPTER 2: READING THE PROGRAM FROM THE PROGRAMMABLE CONTROLLER

2.1 Reading the Program from the Programmable Controller	10
How the Instructions Are Displayed on the LCD	10

CHAPTER 3: SEARCHING FOR RELAY/REGISTER/INSTRUCTION

3.1 Searching for a Relay Used in the Program	16
3.2 Searching for a Register Used in the Program	18
3.3 Searching for the Instruction	20

CHAPTER 4: ENTERING INSTRUCTIONS

4.1 Entering Instructions	24
Entering Basic Instructions.....	26
Entering High Level Instructions	35
4.2 Changing Instructions.....	38
Changing Basic Instructions.....	38
Changing High Level Instructions.....	41
4.3 Inserting Instructions	44
4.4 Deleting Instructions	46
Deleting Instructions With Shifting Addresses	46
Deleting an Instruction Without Shifting Addresses.....	48

CHAPTER 5: OP FUNCTIONS

5.1	Overviewing OP Functions	52
5.2	Selecting OP Functions	53
5.3	Clearing the Program Area and Hold Areas OP-0	55
5.4	Deleting NOP Instructions OP-1	56
5.5	Monitoring and Changing Word Data OP-2, OP-3, OP-8	57
	Monitoring Word Data	57
	Changing the Word Data(Register Value)	59
5.6	Monitoring Relays..... OP-7	60
	Monitoring Other Relays.....	61
5.7	Totally Check the Program OP-9	62
5.8	Forcing the Relays ON/OFF OP-10, OP-11	63
5.9	Monitoring and Changing Double Word Data..... OP-12	66
	Monitoring Double-Word (32-bit) Data (Two Register Values)	67
	Changing the Double-Word Data.....	69
5.10	Changing the Edit Mode of Programmable Controller..... OP-14	70
5.11	Specifying the Link Unit Number..... OP-20	72
5.12	Specifying the Route Number..... OP-21	74
5.13	Changing the Mode of Programmable Controller..... OP-30, OP-31, OP-32	75
5.14	Monitoring and Changing the System Registers..... OP-50	77
	Monitoring System Register Values	77
	Changing the System Register Value.....	78
5.15	Initializing System Registers Settings..... OP-51	79
5.16	Allocating I/O Numbers..... OP-52	80
5.17	Selecting the Display Language..... OP-70	81
5.18	Adjusting the LCD Contrast OP-71	82
5.19	Entering the Registration Open/Closed State for the Password..... OP-72	83
5.20	Registering and Cancel the Password OP-73	84
	Registering a Password	84
	Cancelling the Password	85
5.21	Cancelling the Password (Forced Cancel) OP-74	86
5.22	Transferring a Program to RAM from ROM..... OP-90	87
5.23	Transferring a Program between the Programmable Controller and the FP Programmer II..... OP-91	88
5.24	Transferring System Register Values between the Programmable Controller and the FP Programmer II OP-92	89
5.25	Transferring a Program to ROM from Internal RAM..... OP-99	90
5.26	Display the Self-diagnostic Error Codes on the FP Programmer II OP-110	91
5.27	Clearing Message Displayed on the FP Programmer II OP-111	92
5.28	Turning OFF the ERROR LED on the CPU..... OP-112	93

CHAPTER 6 CARRYING A PROGRAM

6.1 Carrying a Program	96
Transferring a Program between the FP Programmer II and the Programmable Controller	97
Transferring the Program between the FP Programmer II and the NPST-GR	97
Transferring the Program between the FP Programmer II and the Remote NPST-GR	100

APPENDIXES

Appendix A Error Messages	106
Appendix B List of Instructions	123
Appendix C Key Operations	138
Appendix D General Specifications	160
Appendix E Conversion Cable	161
Appendix F Cross Cable	162
Appendix G FP Programmer II Coding Sheet	163
Appendix H FP Programmer I/O List	164
Appendix I Differences between the FP Programmer Series	165
Index	167

What's in each Chapter

Outline

Chapter 1 Before Operating FP Programmer II

Describes what you can do with the FP Programmer II, and basic key operations. Function which each key has will be also explained.

Chapter 2 Reading the Program from the Programmable Controller

Describes how to read the program from the programmable controller and display instructions on the LCD on the FP Programmer II.

Chapter 3 Searching for Relay/Register/Instruction

Describes how to search for relays and registers used in the program stored in the programmable controller, and display them on the LCD.

Chapter 4 Entering Instructions

Describes how to enter, change, insert and delete instructions.

Chapter 5 OP Functions

Introduces about the OP functions, and explains how you can operate OP functions.

Chapter 6 Carrying a Program

The FP Programmer II can be used as a program carrier. On the Chapter 6, how to upload and download program form/to the NPST-GR, a programming software for FP series programmable controller, or the programmable controller.

Appendixes

Error messages displayed on the LCD, instruction lists, key operation lists and general specifications are included here.

Refer them when necessary.

Notation used in this manual

Note Indicates limits to be observed.

Caution Indicates a precaution to be followed.

Abbreviations used in this manual

PLC : FP series programmable controller.

On the FP Programmer II, FP series programmable controller is abbreviated to "PLC".

CHAPTER 1

BEFORE OPERATING FP PROGRAMMER II

1.1	What You Can Do with the FP Programmer II	2
1.2	Part Names.....	3
1.3	Operation Keys	4
1.4	Setting-up the FP Programmer II.....	7

1.1 What You Can Do with the FP Programmer II

The FP Programmer II is a handy programming device for FP series programmable controllers, FP1, FP3, FP5, FP10S, FP10, FP-M, and FP-C. What you can do with the FP Programmer II are introduced on the followings:

With the FP Programmer II, you can:

- read and edit the program stored on the programmable controller. You can edit the program not only when it halts (PROG. mode), but also while the program is being executed (RUN mode).
- monitor the program stored on the programmable controller.
- debug the program stored on the programmable controller. For example, you can check if the program is coded correctly. You can also change register values or turn ON/OFF the relays forcedly (forced input/output operation).
- set the configuration of programmable controller, such as the system registers and the I/O map.
- change the mode of programmable controller; RUN Mode and PROG. Mode.
- set the password to the programmable controller to prevent the program and system register settings from being read or changed by others.
- transfer the program between ROM and internal RAM. If your programmable controller is FP10S or FP10, you can transfer the program between the IC Memory Card mounted on the programmable controller and the RAM.
- store the program and system register settings temporarily in the FP Programmer II transferred from the NPST-GR (programming software) or a programmable controller. The program and system register settings stored in the programmer can also download to the NPST-GR or other programmable controller.
- communicates not only with the programmable controller with which the FP Programmer II is directly connected, but also with the other programmable controller which is linked in the same network (remote programming.)

In addition, you can select the language in which the messages are displayed from English, German, Italian, French, Spanish and Japanese. As the default setting, the messages will be displayed in English.

1.2 Part Names

The following figure shows the front panel of the FP Programmer II. The part names are listed on the below.

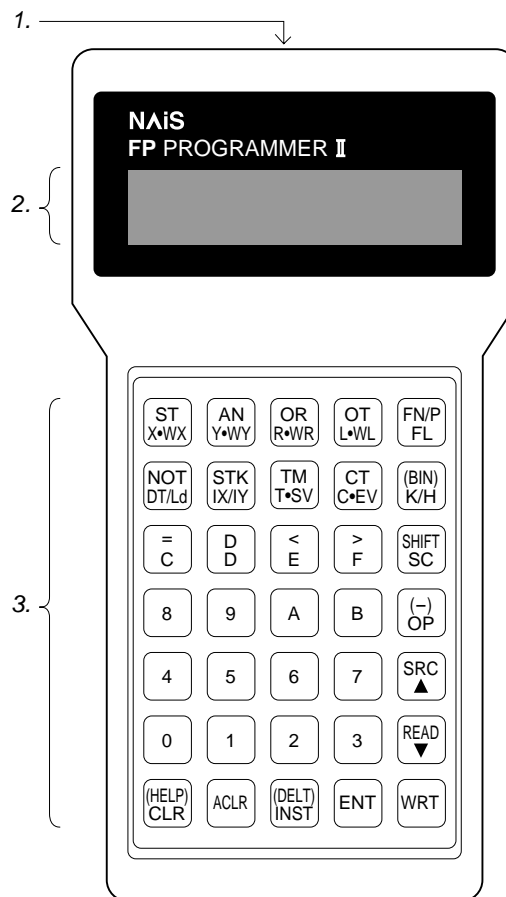

1. Connector

The interface to connect the FP Programmer II with the programmable controller, a personal computer or a modem. When you connect it with the FP1, FP3, FP5, FP10S or FP10, you can use this connector as the RS422 interface. When you connect the FP-M or FP-C, you can use this as the RS232C interface.

2. LCD

The LCD displays instructions and messages. Two lines of data can be displayed at a time. If you operated the FP Programmer II incorrectly, the error message will be displayed at the upper line.



3. Operation keys

With the operation keys, you can operate the FP Programmer II; enter instructions and system register values, and monitor relays or registers.





For details of each key, refer to "1.3 Operation Keys."

1.3 Operation Keys

The FP Programmer II has 35 operation keys on the front panel. You can operate the FP Programmer II using these keys. Every time you press a key, the FP Programmer II beeps once.

Some operation keys have two or more functions. For example, by pressing the  key, you can enter ST, X or WX. What is entered depends on for what you are operating. When you are editing the program, you can enter ST first by pressing the  key. But after you entered any basic instruction name, such as ST or AN, X will be entered with that key. After you entered any high level instruction such as F0 (MV), WX will be entered.

The slash (/) you will see on some operation keys show that the characters separated by that slash can be toggled every time you press that key. For example, by pressing the  key, DT will be entered first. By pressing that key again, DT will disappear and Ld will appear instead. If you press that key once more, DT will appear again.

The character or the function name shown in orange on some operation keys will be valid only after you press the  key. For example, (BIN) shown on the  key is the abbreviation of the “binary.” To display the data as the binary value, press the  key and the  key in that order.

If you enter a wrong data or if you want the FP Programmer II to return to the previous status, press the  key.

If you want the FP Programmer II to return to its initial status, press the  key.

Beep

Every time you press a key, you will hear a beep from the FP Programmer II.

If you tried to enter a value which is out of applicable range, the FP Programmer II will beep twice. So when hearing two beeps, enter the correct value again.

Hearing beeps continuously indicates that you have operated incorrectly. The error message will appear on the upper

line of the LCD. To stop sounding alarm, press the  key, then correct the error as referring to the Appendix A. In the “Appendix A Error Messages”, cause of the error and action you should take are given.

More information for each operation key is given below:

Relay/Instruction keys

ST X•WX	Enters ST (Start) instruction, X or WX (external input relay).
AN Y•WY	Enters AN (AND) instruction, Y or WY (external output relay).
OR R•WR	Enters OR (OR) instruction, R or WR (internal relay).
OT L•WL	Enters OT (OUT) instruction, L or WL (link relay).
FN/P FL	FN shows the scan execution type of high level instruction. P shows the pulse execution type of high level instruction. Every time you press this key, you can toggle FN and P. After you enter an instruction name, you can enter FL (file register) by pressing this key.
NOT DT/Ld	Enters NOT (Not) instruction, DT (data register) or LD (link data register).
STK IX/IY	Enters ANS (AND stack) after you press the AN Y•WY key, and enters ORS (OR stack) after you press the OR R•WR key. You can also enter IX or IY (index register).
TM T•SV	Enters TM (timer) instruction, T (timer contact) or SV (timer/counter preset(set) value).
CT C•EV	Enters CT (counter) instruction, C (counter contact) or EV (timer/counter count (elapsed) value).

Alphanumeric keys

= C	D D	< E	> F	8	9	A	B	Enters numbers or values. After you enter the instruction name, ST, AN or OR, the equality sign (=), another "D" shown above D and the brackets (< and >) will be entered.
4	5	6	7	0	1	2	3	

Note:

- The equality sign (=), D shown above D and the brackets (< and >) are shown on the operation keys of the FP Programmer II version 1.1 or later.

Other keys



Help/Clear key

When displaying instructions, clears the instruction name and the operand currently displayed at the lower line of the LCD. The address will remain. Press this key when you want to enter new instruction at the address.
When monitoring register value, clears the register value to be entered new value.

If you press this key after pressing the  key at the initial status, the basic instruction codes will be listed.

If you press this key after pressing the  key when operating OP Function, OP Function number/names will be listed.



All Clear key

Clears all the data currently displayed.
If you press this key while operating the OP function you will exit that function.
After you press this key, two asterisks (**) will be displayed. This status is called "initial status."



Delete/Insert key

Inserts the instruction which you have just entered.

Deletes the instructions which is displayed at the lower line of the LCD after pressing the  key.



Conversion/Constant key

Enters the constant character K or H. The K and H will be toggled every time you press this key.
You can display register values in the decimal (K) or hexadecimal (H) by pressing this key. You can also display register values in binary when you press the  key and this key in that order.



Shift/SC key

Enters SC mode. In the SC mode, you can enter the basic instructions whose names are not shown on the key pads, such as ED (end) or NOP (not operation) instruction. By pressing this key again, you can exit the SC mode.
This key enable you to use the functions shown in orange on the other key pads. For example, by pressing this key and the

 key in that order, you can delete the instruction.



Operation/Minus key

Enables you to use the OP functions. Press this key after pressing the  key.
Enters a minus (-) for the constants or values.



Search/Up arrow key

Searches the program for the relay (contact), register or instruction.
Scrolls up the address displayed on the LCD.



Read/Down arrow key

Reads instructions, register value or relay status from the programmable controller.
Scrolls down the address displayed on the LCD.



Write key

Writes the instruction, register value or relay status to the programmable controller. You have to press this key after entering the instruction or parameters.



Entry key

Registers high level instruction names, operands of high level instructions, and CT and TM instructions.
Registers the OP function you selected.

1.4 Setting-up the FP Programmer II

Before you start the FP Programmer II, first you must connect the programmer with the programmable controller. The power for the FP Programmer II is supplied from the programmable controller when it is connected with the programmable controller.

This section describes about the communication parameters and how to connect the FP Programmer II.

Communication Parameters

When the FP Programmer II is connected to a programmable controller, first the programmer will automatically check the communication parameters set on the programmable controller, and set the same parameters for itself. So, you do not have to set the parameters for operating the FP Programmer II.

The FP Programmer II will send data to the programmable controller with the following four patterns of communication parameters.

	Baud rate	Data bit	Parity check	Stop bit
Pattern 1	19,200 bps	8 bits	Odd	1
Pattern 2	9,600 bps	8 bits	Odd	1
Pattern 3	19,200 bps	7 bits	Odd	1
Pattern 4	9,600 bps	7 bits	Odd	1

First, the FP Programmer II sends the data with the parameters of the pattern 1. For example, if no response is returned from the programmable controller at that time, the FP Programmer II will soon send the data with the parameters of the pattern 2. If the response is returned by the programmable controller, the FP Programmer II judges that it can communicate with the programmable controller with the parameter of the pattern 2 and starts communicate with the programmable controller.

Note:

- To find the communication parameters with which the FP Programmer II communicates with the programmable controller, check the communication parameters set on the programmable controller.

Default communication parameters for each programmable controller are as shown below:

FP1, FP3, FP5, FP10S, FP10 and FP-C

Baud rate: 19,200 bps
 Data bit: 8 bits
 Parity check: Odd
 Stop bit: 1

You can change the baud rate to 9,600 bps with the “baud rate select switch” on the CPU Unit.

You can change the data bit to 7 bits in the system register No.411, except the FP3 which has the part number whose suffix is C and FP5. The data bit for them is fixed to 8 bits.

FP-M

Baud rate: 9,600 bps
 Data bit: 8 bits
 Parity check: Odd
 Stop bit: 1

Preparing a Cable

To connect the FP Programmer II to the programmable controller, the specific cable is required. The type of cable you can use depends on the type of your programmable controller. Refer to the table below to select the appropriate cable to your programmable controller.

	Cable type	Length	Part number
FP1	FP1 peripheral cable	50 cm (1.64 ft.)	AFP15205
		3 m (9.84 ft.)	AFP1523
FP3	FP peripheral cable	50 cm (1.64 ft.)	AFP5520
FP5		3 m (9.84 ft.)	AFP5523
FP10			
FP10S			
FP-M	FP Programmer cable M5 type	1 m (3.28 ft.)	AFP8523
FP-C		3 m (9.84 ft.)	AFP8521

Connecting the FP Programmer II with the Programmable Controller

When your programmable controller is FP1

Connect the FP Programmer II with the FP1 RS422 port using the FP1 peripheral cable. Plug the female connector of the cable in the RS422 port. Plug the male connector of the cable in the connector of the FP Programmer II.

When your programmable controller is FP3, FP5, FP10 or FP10S

Connect the FP Programmer II with the CPU on the programmable controller using the FP peripheral cable. Plug the female connector of the cable in the RS422 connector on the CPU. Plug the male connector of the cable in the connector of the FP Programmer II.

When your programmable controller is the FP-M or FP-C

Connect the FP Programmer II to the CPU Unit on the programmable controller using the FP Programmer Cable M5 type. Plug female connector of the cable in the RS232C connector on the CPU. Plug the male connector of the cable in the connector of the FP Programmer II.

Immediately after you connect the FP Programmer II to the programmable controller, the power for the FP Programmer II is supplied from the programmable controller, then the message "FP PROGRAMMER II" will be displayed on the LCD. After a few seconds, the message will be replaced with two asterisks (**), which indicates its initial status of the FP Programmer II. Then, you can operate the FP Programmer II.

Notes:

- While the message "FP PROGRAMMER II" is displayed, the FP Programmer II will automatically check the communication status between the FP Programmer II and the programmable controller. If the communication error occurred, the error message "NO RESPONSE ERROR" will be displayed on the LCD. Check the cable and the ALARM LED on the CPU. Make sure that you use the appropriate cable for your programmable controller and it is connected correctly. Also make sure that the ALARM LED is in the OFF state. If the ALARM LED is ON, discriminate the cause, and turn OFF the programmable controller and turn it ON again to reset it.
- When you use the FP10S or FP10, you may also get this error message if you turn ON the programmable controller in the RUN mode with the FP Programmer II connected to that programmable controller. This is not an error. The error message will disappear soon.

CHAPTER 2

READING THE PROGRAM FROM THE PROGRAMMABLE CONTROLLER

2.1	Reading the Program from the Programmable Controller.....	10
-----	---	----

2.1 Reading the Program from the Programmable Controller

You can upload the program stored in the programmable controller in unit of the instruction. Specified an address, the FP Programmer II will read the instruction written in the address specified and display it on the LCD. The LCD has only two lines to display instructions. So, if you read an instruction which has multiple steps and whole instruction cannot be displayed with two lines, you will see dot(s) on the LCD which indicates the number of operands you still see for that instruction. You can see the rest of the instruction by pressing the ▼ key.

Once you specify an address to display the instruction at the address, you can read the following or previous instructions continuously by pressing the ▼ or ▲ keys.

Details are explained in this section.

Note:

- You cannot upload the whole program stored in the programmable controller on the FP Programmer II at a time.

How the Instructions Are Displayed on the LCD

The instruction you read will be always displayed at the lower line of the LCD and the instruction at the lower line is always target instruction for editing.

When you read the instruction by specifying an address, the instruction will be displayed at the lower line with the address. Nothing will be displayed at the upper line.

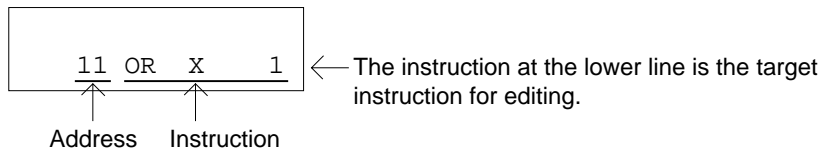

When reading the instruction at address 11

If you continuously read the instruction at the next address by pressing the ▼ key, the instruction currently displayed at the lower line will be shifted to the upper line, and the instruction you just read will be displayed at the lower line.



If you continuously read the instruction at the previous address pressing the ▲ key, the instruction displayed at the lower line will disappear and the one you have just read will appear at the lower line.

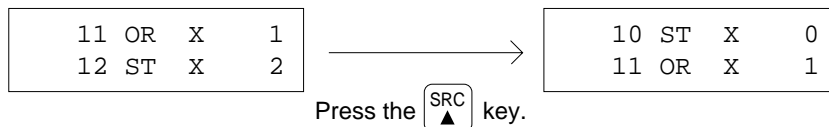

If you press the ▲ key immediately after you read the instruction by specifying the address, the instruction at the lower line will disappear and the instruction(s) at the previous two addresses will be displayed.



Notes:

- Even if you press the ▲ key when the address 0 is already displayed at the lower line of the LCD, the display on the LCD will not be changed. Address 0 is the first address of a program.
- When you press the ▲ key when the address 1 is displayed at the lower line of the LCD, the instruction currently displayed will disappear and the instruction at previous address, 0, will be displayed at the position. On the upper line, nothing will be displayed because the address 0 is the very first address of a program.

When you read High Level Instructions

When you specify the address where the instruction which requires more than one line to be displayed on the LCD, the instruction will be displayed from its head address including the instruction name. Instructions such as High Level Instructions, TM instruction, CT instruction require more than one lines.

For example, if you specify address “3” and the TM instruction (3 steps) uses the addresses from 1 to 3, the instruction will be displayed from the address 1, not from the address 3.

Program stored in the programmable controller

Address	Instruction
0	ST X 1
1	TM X 0
	SV 0
4	ST/ T 0
5	TM X 1

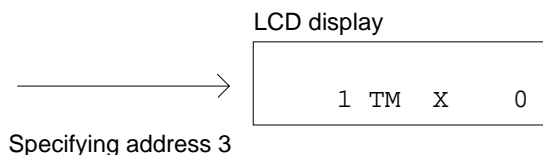

If you press the ▼ key when one of these instructions is being displayed at the lower line of the LCD, you can see rest of the instructions.

If you press the ▼ key once, the instruction name will be shifted to the upper line and the first operand will be displayed at the lower line. On the next to the instruction name, you will see dot(s). The number of dots indicates the number of operands which will follow. Every time you press the ▼ key, the next operand will be displayed and the number of the dots will be reduced by one. After all the operands are read and you press the ▼ key again, the next instruction will appear.

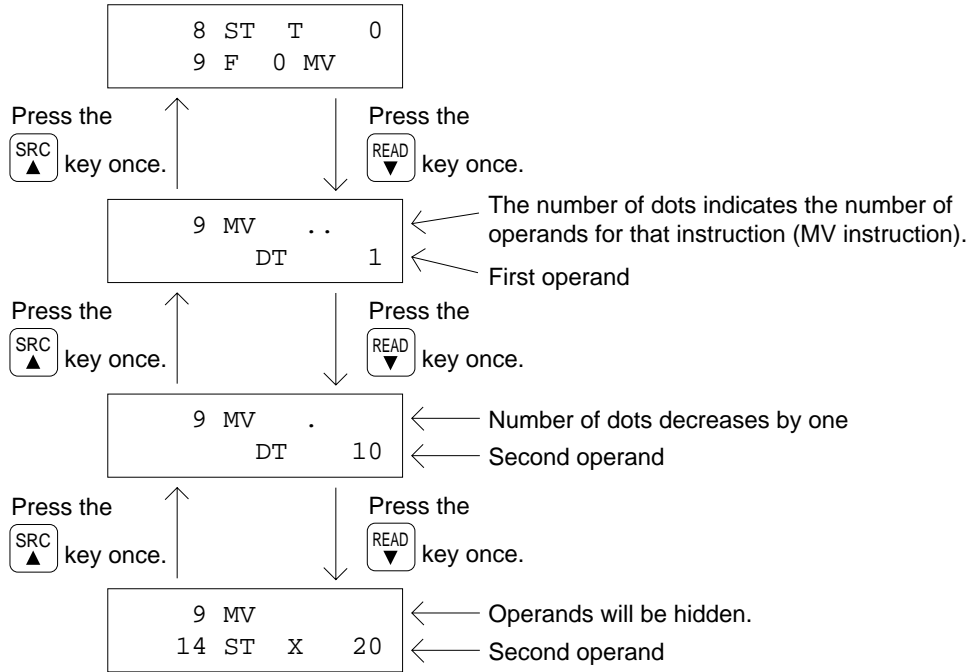

When a High Level Instruction or CT or TM instruction is displayed at the upper line of the LCD, and press the ▲ key, the instruction will be displayed from the last operand. On the figure above, the MV instruction will be displayed from the last one.

Monitoring Relays

When you read an instruction applied the relay (contact) X, Y, R, T, C or L, you can monitor the ON/OFF status of the relay. When the relay is in the ON state, the space between the address and the instruction name will be reversed. When it is in the OFF state, the area will not be reversed.

When the relay X0 is in the ON state:

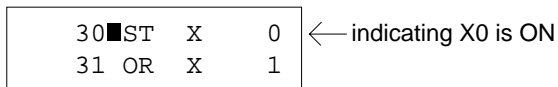

Procedure

On the following procedure, it is assumed that you read the instruction at the address 5.

1. Press the **ACLR** key to clear the data displayed on the LCD.
The FP Programmer II will become its initial status.



2. Enter the address. You can enter up to five digits number.
If you enter more digits number, the number will be disappear one by one from the leftmost digit.

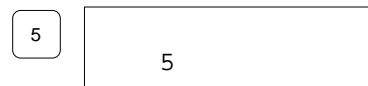

For example, press the **5** key to read the instruction at address 5.

Notes:

- When you specify the address larger than the maximum address of the program, the FP Programmer II will beep twice to tell you that you entered invalid address.
- If your programmable controller is FP10S or the FP10 and you entered invalid address, an error message "ADDRESS ERR !66" will be displayed. Press the **CLR** key to cancel the error, and enter the address which is equal or smaller than the maximum address.

3. Press the **READ** key.
The instruction at the address you specified will be displayed at the lower line of the LCD.

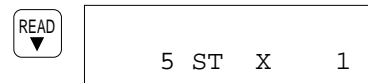

By pressing the ▼ key, you can read the instruction at the next address. The instruction currently displayed at the lower line of the LCD will be shifted to the upper line. The instruction you have just read will be displayed at the lower line.

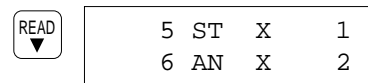

To read the instruction at the previous address, press the ▲ key. The instruction currently displayed at the lower line of the LCD will disappear and the one you have just read will appear there. At the upper line, the instruction which exists at the previous address will appear.

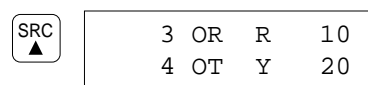

By holding down the ▼ or ▲ key, you can read the instructions continuously.

CHAPTER 3

SEARCHING FOR RELAY AND REGISTER

3.1	Searching for a Relay Used in the Program	16
3.2	Searching for a Register Used in the Program	18
3.3	Searching for the Instruction	20

3.1 Searching for a Relay Used in the Program

You can search for a relay(contact) used in the program which is stored in the programmable controller by specifying the relay name and relay number. The relay types you can search for are X, Y, R, T, C and L.

The FP Programmer II will begin searching for the target relay from the beginning of the program. If you specify an address, it will begin the searching operation from the address specified.

When the first corresponding relay is found, the address where that relay exists will be displayed on the LCD. You can search for the same relay which exists at the rest of addresses one by one. You can also read the instruction which uses the relay detected as the operand and the address where the instruction exists.

Procedure

On the following procedure it is assumed that you search for the relay X0 from the address 5.

1. Clear the LCD by pressing the **ACLR** key.
The FP Programmer II will become its initial status.



2. If you want to search for the relay from the beginning of the program, skip this step and jump to the step 3.
If you want to search for the relay from the desired address, enter that address. The address you entered will be displayed.

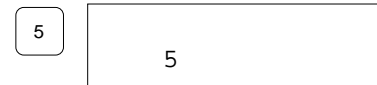

For example, to begin searching a relay from address 5, press the **5** key.

3. Enter the relay name you want to search for, by pressing the **X, Y, R, L, T** or **C** key. The relay name will be displayed.

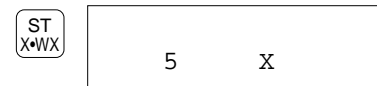

If you specified the address in the step 2, the relay name will be displayed at the right of the address.

For example, to enter the relay X, press the **X** key.

4. Enter the relay number. The relay number will be displayed at the right of the relay name.

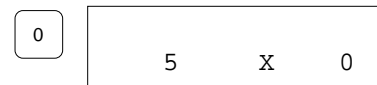

For example, to enter the relay number "0," press the **0** key.

5. Press the **SRC** key to start searching for the relay specified. When the relay you entered is found, the address where the relay exists will be displayed at the lower line of the LCD. At the upper line, the address, if specified, and the target relay will be displayed. On the figure right, it indicates “X0” was detected at the address 28.

SRC ▲	5	X	0
	28		

By pressing the **SRC** key again, you will search for the same relay which exists at the rest of addresses.

SRC ▲	5	X	0
	30		

By pressing the **READ** key when the address is displayed, you can read the instruction at the address. If you press the **READ** key, the FP Programmer II will end the searching operation, then display the instruction.

READ ▼	30	ST	X	0
-----------	----	----	---	---

When the relay you entered is not found, the FP Programmer II will return its initial status.

**

3.2 Searching for a Register Used in the Program

You can search for the register (word data) used in the program which is stored in the programmable controller by specifying the register name and register number. The register types you can search for are WX, WY, WR, WL, SV, EV, DT, LD and FL.

The FP Programmer II will begin searching for the target register from the beginning of the program. If you specify an address, the FP Programmer II will begin the searching operation from the address specified.

When the first corresponding register is found, the address where the register exists will be displayed. You can search for the same register at the rest of addresses one by one. You can also read the instruction which uses the register detected as the operand and the address where the instruction exists.

Procedure

On the following procedure, it is assumed that you search for the register DT0 from the address 5.

1. Clear the LCD by pressing the **ACLR** key.
The FP Programmer II will become its initial status.



2. If you want to search for the register from the beginning of the program, skip this step and jump to the step 3.
If you want to search for the register from the desired address, enter that address with numeric keys. The address you entered will be displayed.

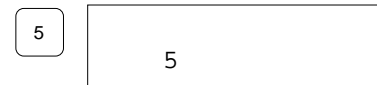

For example, to begin searching a register from address 5, press the **5** key.

3. Enter the register name you want to search for.
To enter WX, WY, WR, WL, SV, or EV, respectively press the **X**, **Y**, **R**, **L**, **T** or **C** key twice.
The **DT/Ld** and **IX/IY** keys toggle DT and Ld, and IX and IY respectively.
To enter FL, press the **FL** key.

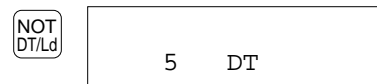

The register name will appear on the LCD. If you specified the address in the step 2, the register name will be displayed at the right of the address.

For example, press the **DT/Ld** key once to search for the register "DT".

4. Enter the register number. The register number will be displayed at the right of the register name.

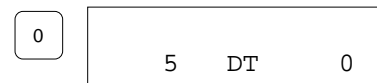

For example, to enter the register number "0," press the **0** key.

5. Press the **SRC** key to start searching for the register specified.

When the register you entered is found, the address where the register exists will be displayed at the lower line of the LCD. At the upper line, the address, if specified, and the target register will be displayed.

On the figure below, it indicates “WX0” was detected at the address 38.

SRC ▲	5	DT	0
	38		

By pressing the **SRC** key again, you will search for the same register which exists at the rest of addresses.

SRC ▲	5	WX	0
	62		

By pressing the **READ** key when the address is displayed, you can read the instruction at the address.

If you press the **READ** key, the FP Programmer II will end the searching operation, then display the instruction.

READ ▼	62	F	0	MV

Pressing **READ** key, you can check the operand.

When the register you entered is not found, the FP Programmer II will return its initial status.

**

3.3 Searching for the Instruction

You can search for the instruction used in the program stored in the programmable controller by specifying the instruction name and the operands.

The FP Programmer II will begin searching for the target instruction from the beginning of the program. If you specify an address, the FP Programmer II will begin the searching operation from the address specified.

When the first corresponding instruction is found, the address where the instruction exists will be displayed. You can search for the same instruction at the rest of addresses one by one.

Procedure

On the following procedure, it is assumed that you search for the ST instruction (ST X0) from the address 5.

1. Clear the LCD by pressing the **ACLR** key.
The FP Programmer II will become its initial status.



2. If you want to search for the instruction from the beginning of the program, skip this step and jump to the step 3.
If you want to search for the instruction from the desired address, enter that address. The address you enter will be displayed.

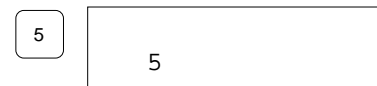

For example, to begin searching an instruction from address 5, press the **5** key.

3. Press the **SC** key to search an instruction.
An under bar will appear at the lower line of the LCD. If you specified an address, it will appear at the next of the address.

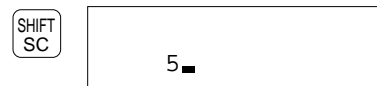

4. Enter the instruction you want to search for.
To enter the instruction, refer to "4.1 Entering Instructions".

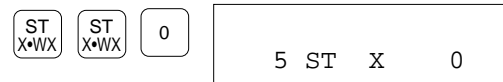

For example, press **ST**, **X** and **0** keys in that order to search for the instruction "ST X0".

5. Press the **SRC** key to start searching for the instruction specified.

SRC ▲	5 ST X 0
	30

When the instruction you entered is found, the address where the instruction exists will be displayed at the lower line of the LCD.

At the upper line, the address, if specified, and the target instruction will be displayed.

On the figure below, it indicates the instruction “ST X0” was detected at the address 30.

By pressing the **SRC** key again, you will search for the same instruction which exists at the rest of addresses.

SRC ▲	5 ST X 0
	80

By pressing the **READ** key when the address is displayed, you can read the instruction at the address.

If you press the **READ** key, the FP Programmer II will end the searching operation, then display the instruction.

READ ▼	80 ST X 0
-----------	-----------

When the instruction you enter is not found, the FP Programmer II will return its initial status.

**

CHAPTER 4

ENTERING INSTRUCTIONS

4.1	Entering Instructions.....	24
4.2	Changing Instructions.....	38
4.3	Inserting Instructions	44
4.4	Deleting Instructions.....	46

4.1 Entering Instructions

To enter an instruction, first you must read the instruction written at the address where you want to enter the instruction from the programmable controller. Then you enter the instruction on the FP Programmer II and write it to the programmable controller.

To read an instruction, refer to “Chapter 1 Reading a Program from the Programmable Controller”. On the procedure described below, briefly the method to read an instruction will be also introduced.

Once you read an address, you can enter instructions continuously. After completing entering an instruction, the FP Programmer II will read the instruction at following address and display it at the lower line of the LCD. The instruction you just entered will be displayed at the upper line of the LCD.

By pressing ▼ or ▲ key, you can go to the address you want. FP Programmer II will scroll the address down/up one address by a key press.

As the default settings, NOP instructions are entered for every address in the programmable controller. So, if you read the address where you have not entered an instruction, NOP instruction will be displayed on the LCD with its address.

Note that the instruction displayed at the lower line of the LCD is the target instruction for editing.

To Edit the Program in the RUN mode

You can edit the program while the programmable controller is in the RUN mode. To edit the program in the RUN mode, set the FP Programmer II so that you can access to the running program by operating the OP-14. For the operation details, refer to “5.10 Changing the Edit Mode of Programmable Controller”

As an example, how to enter the following instructions are explained below, starting from reading the address. For details to enter each instruction, refer to the two sections, “Entering Basic Instructions” and “Entering High Level Instructions”, described later on.

Address	Instruction
0	ST X10
1	OT Y20

Procedure

Reading the address

1. Press the **ACLR** key to clear the LCD.
The FP Programmer II will become its initial status.



2. Enter the address from where you want to enter instructions.
Use the alphanumeric keys to enter the address.

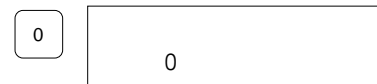

On the example, you will enter instructions, from the address 0.
So, press **0** key to read the contents of address 0.

3. Press the **READ** key.
The instruction written at the address will be read from the programmable controller and it will be displayed at the next to the address.

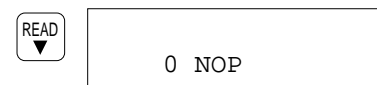

Entering instructions

4. Press the **ST** key to enter a ST instruction.

ST
X*WX

0 ST

5. Press the **X**, **1** and **0** keys in that order to enter the operand, X10.

ST
X*WX

1

0

0 ST X 10

6. Press the **WRT** key to write the instruction to the programmable controller. The instruction you just entered will be displayed at the upper line, and the instruction at the following address will be displayed at the lower line.
Now the address 1 is subjected to the entry.

WRT

0 ST X 10
1 NOP

7. Press the **OT** key to enter a OT instruction.

OT
L*WL

0 ST X 10
1 OT

8. Press the **Y**, **2** and **0** keys to enter the operand, Y20.

AN
Y*WY

2

0

0 ST X 10
1 OT Y 20

9. Press the **WRT** key to write the instruction to the programmable controller. The instruction you just entered will be displayed at the upper line, and the instruction at the following address will be displayed at the lower line.

WRT

1 OT Y 20
2 NOP

To finish the entry to operate another operation, press the **ACLR** key. The FP Programmer II will become its initial status.

Caution:

- Never fail to press the **WRT** key after entering an instruction.
By pressing the **WRT** key, the instruction you entered on the FP Programmer II will be written to the programmable controller.

Entering Basic Instructions

Notes:

- The basic instructions your programmable controller supports will be listed in the “Appendix B.”
- For details of each instruction, refer to the Programming Manual for your programmable controller.
- On this section, it is assumed that you already read the address where you enter an instruction.

ST AN OR OT

The methods to enter the ST, AN, OR and OT are almost the same. As an example, the following figures assume that you enter a ST instruction(ST X 0) at the address 0.

Procedure

1. Enter the instruction name by pressing one of **ST**, **AN**, **OR** or **OT** key.

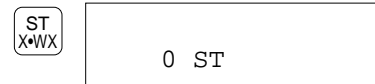

2. Enter the relay (contact) name used as its operand, by pressing **X**, **Y**, **R**, **T** or **C** key.

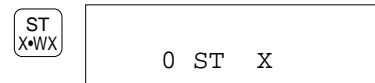

3. Enter the relay (contact) number, by using the alphanumeric keys.

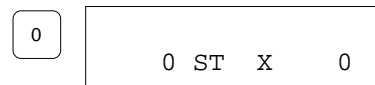

4. Press the **WRT** key to write the instruction to the programmable controller. The instruction you entered will be displayed at the upper line and instruction at the next address will appear at the lower line of the LCD.

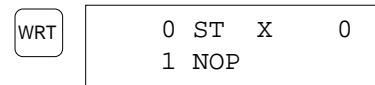

TM

On the following figures, it is assumed that you enter a TM instruction (0.1 sec. timer, number 200 whose K constant is 50) at the address 10.

Procedure

1. Press the **TM** key to enter the instruction name, TM.

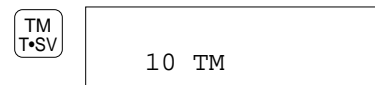

2. Press **X**, **Y**, or **R** key to select the ON-delay timer type.

Press:	To enter:
X	ON-delay timer for 0.01s units
Y	ON-delay timer for 0.1s units
R	ON-delay timer for 1s units

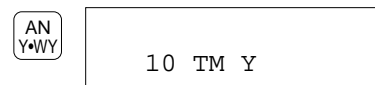

3. Press the timer number using the alphanumeric keys.

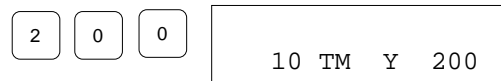

4. Press the **ENT** key.

The LCD will be changed as shown on the right. The number of dots next to the timer type shows the number of operands you still must enter.

ENT	10 TM Y. 200
-----	--------------

5. Press the **K/H** key.

Note that only the K constant is available for the TM instruction.

(BIN) K/H	10 TM Y. 200 K
--------------	-------------------

6. Enter the constants using the alphanumeric keys.

1	10 TM Y. 200 K	1
---	-------------------	---

7. Press the **WRT** key to write the instruction to the programmable controller. The instruction name you entered will be displayed at the upper line and instruction at the next address will appear at the lower line of the LCD.

WRT	10 TM Y 200 14 NOP
-----	-----------------------

Operand of TM instruction will be hidden.

CT

On the following figures, it is assumed that you enter a CT instruction (counter number 100 whose set(preset) value is 50) at the address 10.

Procedure

1. Press the **CT** key to enter the CT instruction.

CT C•EV	10 CT
------------	-------

2. Enter the counter number using the alphanumeric keys.

1	0	0	10 CT	100
---	---	---	-------	-----

3. Press the **ENT** key.

The LCD will be changed as follows. The number of dots shows the number of operands you still must enter.

ENT	10 CT . 100
-----	-------------

4. Press the **K/H** key.

Note that only the K constant is available for the CT instruction.

(BIN) K/H	10 CT . 100 K
--------------	------------------

5. Enter the constants using the alphanumeric keys.

5	0	10 CT . 100 K	50
---	---	------------------	----

6. Press the **WRT** key.

The instruction name you entered will be displayed at the upper line and instruction at the next address will appear at the lower line of the LCD.

WRT	10 CT 100 14 NOP
-----	---------------------

Operand of CT instruction will be hidden.

ST/ AN/ OR/ DF/

You can enter the ST/, AN/, OR/ and the DF/ with almost the same method.

On the following figures, it is assumed that you enter a ST/ instruction (ST/ X0) at the address 10.

Procedure

1. Enter the instruction name by pressing one of **ST**, **AN**, **OR** or **OT** key.

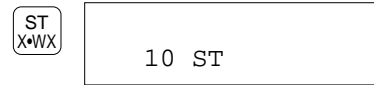

2. Press the **NOT** key to enter the slash(/).



3. Enter the relay (contact) name used as its operand, by pressing **X**, **Y**, **R**, **T** or **C** key.

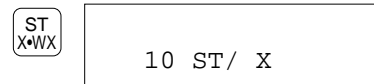

4. Enter the relay (contact) number using the alphanumeric keys.

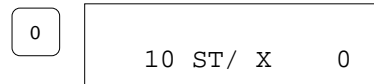

5. Press the **WRT** key to write the instruction to the programmable controller. The instruction you entered will be displayed at the upper line and instruction at the next address will appear at the lower line of the LCD.

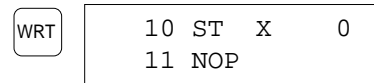

NOT

On the following figures, it is assumed that you enter the NOT at the address 10.

Procedure

1. Press the **NOT** key.

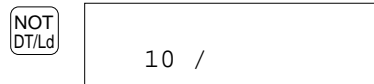

2. Press the **WRT** key to write the instruction to the programmable controller. The NOT instruction you just entered will be displayed at the upper line and instruction at the next address will appear at the lower line of the LCD.

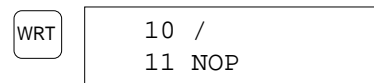

ANS ORS

To enter a ANS instruction, use the **AN** key and the **STK** key. To enter a ORS instruction, use the **OR** key and the **STK** key. The methods to enter the ANS and the ORS are almost the same.

It is assumed that you connect the “ST X 0, OR X 1” at the address 0 and 1, and “ST X 2, OR X 3” at the address 2 and 3 in series by entering a ANS instruction at the address 5.

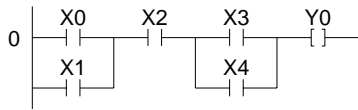

Also, it is assumed that “ST X 0”, “OR X 1”, “ST X 2” and “OR X 3” have been already entered.

Procedure

- 1 Press the **AN** or **OR** key.

AN
Y•WY

4	OR	X	3
5	AN		

- 2 Press the **STK** key. AN will be changed to ANS, or OR will be changed to ORS as shown on the right.

STK
IX/IY

4	OR	X	3
5	ANS		

- 3 Press the **WRT** key.

The instruction you just entered will be displayed at the upper line and instruction at the next address will appear at the lower line of the LCD.

WRT

5	ANS		
6	NOP		

Comparison Instructions for Word Data

The comparison instructions which treat a single-word data are:

ST = ST < ST > ST <= ST >= ST <>
 AN = AN < AN > AN <= AN >= AN <>
 OR = OR < OR > OR <= OR >= OR <>

The methods to enter the comparison instructions listed above are almost the same.

As an example, how to enter the ST <= instruction whose first operand is DT 0 and the second operand is DT 1 is explained.

Procedure

1. Enter the instruction name.

For example, press the **ST**, **<**, and **=** keys in that order to enter a ST <= instruction.



2. Press the **ENT** key.

The LCD will be changed as shown on the right. The number of dots next to the instruction name shows the number of operand you must enter for the instruction.

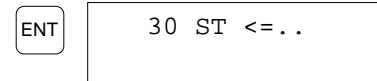

3. Enter the first operand.

For example, press the **DT/Ld** and **0** keys in that order to enter DT0.

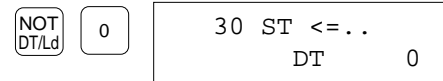

4. Press the **ENT** key.

The first operand will be registered and disappear from the screen. Note that the number of dots will be decreased by one.

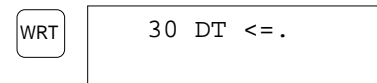

5. Enter the second operand.

For example, press the **DT/Ld** and **1** key in that order to enter DT1.

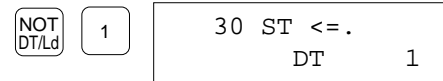

6. Press the **WRT** key to write the instruction to the programmable controller. The instruction name you entered will be displayed at the upper line and instruction at the next address will appear at the lower line of the LCD.

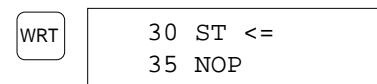

Operands of ST <= instruction will be hidden.

Comparison Instructions for Double Data

The comparison instructions which treat the double words are:

STD = STD < STD > STD <= STD >= STD <>
 AND= AND< AND> AND<= AND>= AND<>
 ORD= ORD< ORD> ORD<= ORD>= ORD<>

The methods to enter the comparison instructions listed above are almost the same.

As an example, how to enter a STD <> instruction whose first operand is K8 and the second operand is DT0 is explained.

Procedure

- Enter the instruction name.
For example, press the **ST**, **D**, **<**, and **>** keys in that order to enter a STD <> instruction.
- Press the **ENT** key.
The LCD will be changed as shown on the right. The number of dots next to the instruction name shows the number of operand you must enter for the instruction.
- Enter the first operand.
For example, press the **K/H**, **8** key in that order to enter K8.
- Press the **ENT** key.
The first operand will be registered and disappear from the screen. Note that the number of dots will be decreased by one.
- Enter the second operand.
For example, press the **DT/Ld** and **0** keys in that order to enter DT0.
- Press the **WRT** key to write the instruction to the programmable controller. The instruction name you entered will be displayed at the upper line and instruction at the next address will appear at the lower line of the LCD.

The LCD shows the address 30 and the instruction STD<>. To the left of the instruction, the keys pressed are shown: ST (X*WX), D, D, < (E), and > (F).

After pressing the ENT key, the LCD shows 30 STD<>.. The ENT key is shown to the left.

After pressing the K/H and 8 keys, the LCD shows 30 STD<>.. K 8. The (BIN) K/H key and the 8 key are shown to the left.

After pressing the ENT key, the LCD shows 30 STD<>.. The ENT key is shown to the left.

After pressing the DT/Ld and 0 keys, the LCD shows 30 STD<>. DT 0. The NOT DT/Ld key and the 0 key are shown to the left.

After pressing the WRT key, the LCD shows 30 STD<> on the upper line and 39 NOP on the lower line. The WRT key is shown to the left.

Operands of STD <> instruction will be hidden.

Other Basic Instructions

You can enter the basic instructions which are not shown on the operation keys by specifying the “basic instruction code.” How to enter the basic instructions and how to list the basic instruction codes are described in this section. The basic instructions which are entered by specifying the basic instruction codes are:

DF	NOP	KP	SR	MC	MCE	JP	LBL	LOOP	PSHS
RDS	POPS	SSTP	NSTP	CSTP	STPE	ED	CNDE	CALL	SUB
RET	ICTL	INT	IRET	BRK	SET	RST	NSTL		

The following table lists the basic instruction codes.

With the help function, you can list the codes on the FP Programmer II.

Code	Instruction
0	DF
1	NOP
2	KP
3	SR
4	MC
5	MCE
6	JP
7	LBL
8	LOOP
9	PSHS
A	RDS
B	POPS
C	SSTP
D	NSTP
E	CSTP
F	STPE
10	ED
11	CNDE
12	CALL
13	SUB
14	RET
15	ICTL
16	INT
17	IRET
18	BRK
19	SET
1A	RST
1B	NSTL

When You Know the Basic Instruction Code:

As an example, it is assumed that you enter a JP instruction (JP 5) at the address 10.

Procedure

1. Press the **SC** key. An under bar will appear at the next to the address.

SHIFT
SC

10_NOP

2. Enter the basic instruction code.

For example, to enter JP instruction whose code is “6,” press the **6** key.

6

10_ 6 JP

If you entered a wrong basic instruction code, enter the correct code with two-digit. The number currently entered will be shifted to the left by entering a new number.

3. Press the **SC** key again to register the instruction name in the FP Programmer II.
The LCD will be changed as shown on the right. The under bar and code will disappear on the LCD.

SHIFT
SC

10 JP

4. If any, enter the operand.

For example, press **5** key to enter the operand of JP instruction.

5

10 JP 5

5. Press the **WRT** key to write the instruction you entered to the programmable controller.
The instruction name you entered will be displayed at the upper line and instruction at the next address will appear at the lower line of the LCD.

WRT

10 JP 5
12 NOP

When You Do Not Know the Basic Instruction Code:

If you do not know the code, you can list the codes on the FP Programmer II. Follow the procedure below.

As an example, it is assumed that you enter the JP instruction (JP 5) at the address 10.

Procedure

1. Press the **SC** key. An under bar will appear at the next to the address.

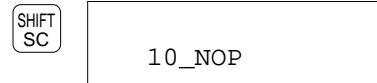

2. Press the **(HELP)** key. Basic instruction codes list will be displayed on the LCD. Four basic instruction codes and the corresponding instruction names are displayed at a time.



3. Press the **▲** key or **▼** key to scroll the basic instruction codes to look for the desired one. The list will be scrolled by one line every time you press the key.

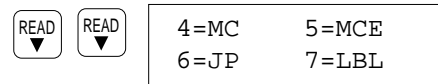

4. When you find the desired basic instruction code, enter the code with alphanumeric keys. Note that you can enter only the basic instruction code which is now displayed on the LCD. After the entry, the list will disappear and the LCD will display the instructions with the instruction name you selected from the list.

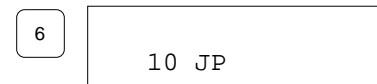

For example, press the **6** key to enter a JP instruction.

When you entered wrong code:

Repeat the operation from the step 1.

5. If any, enter the operand.

For example, press **5** key in that order to enter the operand of JP instruction.

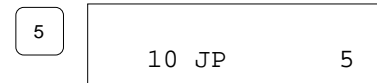

6. Press the **WRT** key to write the instruction you entered to the programmable controller. The instruction name you entered will be displayed at the upper line and instruction at the next address will appear at the lower line of the LCD.

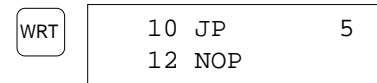

Entering High Level Instructions

Notes:

- The high level instructions your programmable controller supports will be listed in the “Appendix B.”
- For more information about the high level instructions, refer to the Programming Manual for your programmable controller.
- On this section, it is assumed that you already read the address where you enter an instruction.

Notes for Entering a High Level Instruction

To enter a high level instruction, you must select “F” or “N” to decide which instruction you are going to enter, scan execution type (F) or pulse execution type (P), then enter high level instruction number. After you register the instruction name, you are ready to enter the corresponding operands.

To select the type of high level instruction, you must use the **FN/P** key.

Press the **FN/P** key once when you want to enter a scan execution type of instruction (F instruction).



50 F

Press the **FN/P** key again when you want to enter a pulse execution type instruction number (P instruction).



50 P

The **FN/P** key toggles the FN(F) and P every time you press the key.

Then, you can enter the instruction number you want to enter with numeric keys. If you enter a number, the corresponding instruction name will appear with the number.



50 P 0 MV

When you enter the instruction number, 0

Notes:

- When you enter two or three digits instruction number, the FP Programmer II will display, if any, the corresponding instruction every time you press a numeric key. For example, when you enter F111 WSHL instruction, you will press the key three times to enter the instruction number, and the LCD will change as follows every time you press the **1** key.

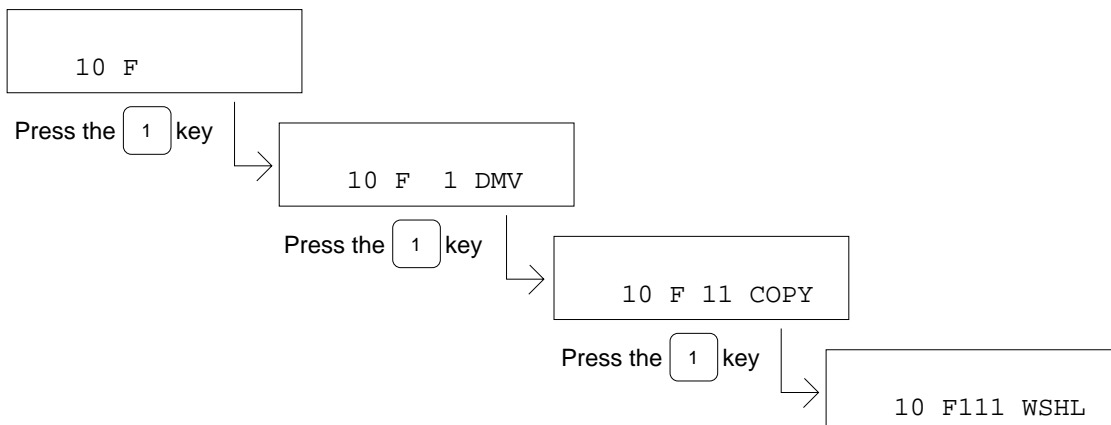

4.1 Entering Instructions

- If you enter an instruction number which does not correspond to any of instructions, instruction name will not displayed. Press the **CLR** key, then enter the correct number again.

10 F4

When the instruction name you are going to enter is registered, the FP Programmer II will display “dots” to indicate how many operands you should enter for that instruction. The number of dots indicates the number of operands, and the number will be decreased by one every time you enter an operand.

50 MV ..

For example, when you enter a MV instruction, two dots will appear.

After entering an operand, you must register it by pressing the **ENT** key. However, when you see only one dot left, which indicates that you must enter last operand, you must press the **WRT** key, instead of the **ENT** key, after entering the last operand. Thus the instruction will be written to the programmable controller.

For example, for a MV instruction, you will enter the first operand, and press the **ENT** key. Then you are ready to enter the second operand. Because the MV instruction has two operands, the second operand is the last operand to be entered for that instruction. So, after you enter the second operand, you must press the **WRT** key, not the **ENT** key, to write the instruction to the programmable controller.

Entering a High Level Instruction

Follow the procedure described below to enter a high level instruction.

Procedure

On the procedure, it is assumed that you enter a F0(MV) at the address 10. The first operand is DT 0 and the second operand is DT 1.

Before the operation, make sure the address where you want to enter an instruction is displayed at the lower line of the LCD.

10 NOP

1. Press the **FN/P** key once to enter a scan execution type of instruction.
The character, “F” will be displayed.

FN/P
FL

10 F

If you want to enter a pulse execution type of instruction, press the **FN/P** key twice. The character “P” will be displayed.

2. Enter a high level instruction number you want to enter, with numeric keys.
The high level instruction number and the corresponding name will be displayed.
Press the **0** key to enter an F0 instruction.

0

10 F 0 MV

3. Press the **ENT** key to register the instruction name.
The address, instruction name and dots will be displayed as shown on the right.
The number of dots indicates the number of operands to be entered for the instruction.

ENT

10 MV ..

4. Enter the first operands.

For example, press the **DT** and **0** keys in that order to enter DT0.

NOT DT/Ld	0	10 MV . . DT 0
--------------	---	-------------------

5. Press the **ENT** key to register the first operand.

The lower line where the first operand you have just entered will be cleared, and one dot will be decreased.

ENT	10 MV .
-----	---------

6. Enter the second operand.

For example, press the **DT** and **1** keys in that order to enter DT1.

NOT DT/Ld	1	10 MV . DT 1
--------------	---	-----------------

7. Press the **WRT** key to write the instruction to the programmable controller. When you see only one dot left on the LCD, you must press the **WRT** key after enter the operand for the dot (last operand).

WRT	10 MV 15 NOP
-----	-----------------

Operands will be hidden

Note:

- To use the IX or IY as the address modifier like “IXDT,” first enter the IX or IY, enter the register such as DT to be modified and enter the register number.
- To enter the minus(-) to enter the negative K constant, press the **SHIFT, (-)** keys in that order. The minus(-) will appear next to the K, like “K-.” Then, enter the constants.

4.2 Changing Instructions

On this section, how to change an instruction written in the programmable controller to another instruction will be explained.

Changing Basic Instructions

To change a Basic Instruction to another instruction, you clear the instruction to be changed with the **CLR** key, then enter the new instruction.

If you change only relay (contact) number which is used as the operand of a basic instruction, you do not have to enter all the new instruction. Entering the new relay number can change the instruction.

Notes on Changing the Instructions

If you change the instruction to the instruction whose number of steps is the larger, basically the addresses of all the instructions which exist below the new instruction will be shifted downward.

For example, when you change the OT instruction (one step) to the CT instruction (three steps), the addresses of the instructions below the OT instruction will be shifted downward as much as two addresses.

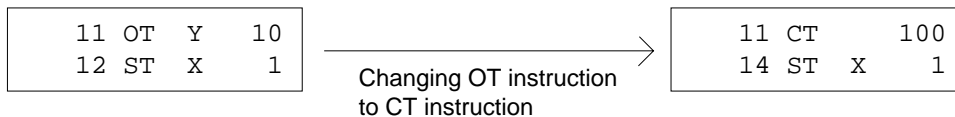

If the NOP instructions exist between the instruction you are going to change and the next instruction as shown below, NOP instructions as many as the number of steps exceeded resulting in the change will be replaced with the new instruction, and the addresses as many as the NOP instructions replaced may not be shifted downward.

For example, it is assumed that the OT instruction (one step) is changed to the CT instruction (three steps) and that three NOP instructions exist below the OT instruction. Then, the OT instruction and the first and second NOP instructions will be replaced with the CT instruction. The third NOP instruction will remain.

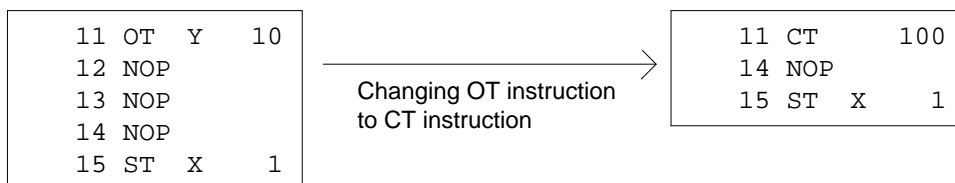

If you change the instruction to the one whose number of steps is the smaller, NOP instructions as many as the steps decreased resulting in the change, will be automatically entered after the new instruction.

For example, when you change the CT instruction (three steps) to the OT instruction (one step), two NOP instructions will be entered below the OT instruction. The addresses will not be shifted.

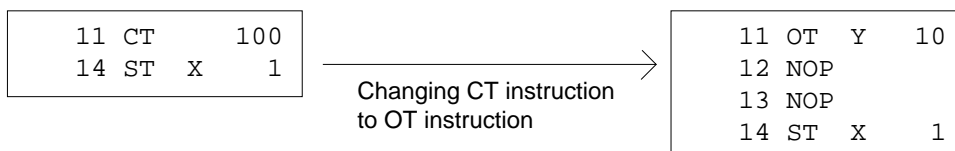

Changing Only Relay Number

If you change only the relay number (contact number), follow the procedure below. Otherwise follow the procedure described in “Changing a Basic Instruction”.

On the following procedure, it is assumed that you change “ST X 1” to “ST X A”.

Procedure

1. Display the instruction you want to change to another one at the lower line of the LCD. Read the instruction from the programmable controller by specifying the address, or by pressing ▲ or ▼ key.

18	ST	X	1
----	----	---	---

Refer to “Chapter 2” for operation details.

2. Enter the new relay number using the alphanumeric keys. It is recommended that first you enter four zeros (0000) to initialize the area for entering the relay number, and enter the new number. If you do not initialize it, the existing numbers will be shifted one-digit to the left when you enter a new number.

0	0	0	0	18	ST	X	A
0	A						

For example press the **0** key four times, then press the **A** key to enter “A”.

3. Press the **WRT** key. The instruction with the new relay number will be written to the programmable controller.

WRT	18	ST	X	A
	19	AN	X	1A

Changing a Basic Instruction

When you want to change a basic instruction name or the relay name used as the operand of a basic instruction, you must enter the new basic instruction from the beginning.

Refer to “4.1 Entering Instructions” to enter the new instruction.

On the following procedure, it is assumed that you change the AN instruction (AN X 0) at the address 10 to the OR instruction (OR X 0).

Procedure

1. Display the instruction you want to change to another one at the lower line of the LCD. Read the instruction from the programmable controller by specifying the address, or by pressing ▲ or ▼ key.

10	AN	X	0
----	----	---	---

Refer to “Chapter 2” for operation details.

2. Press the **CLR** key. The instruction will be cleared.

(HELP) CLR	10			
---------------	----	--	--	--

3. Enter the new instruction. For example, press the **OR**, **X** and **0** keys in that order to enter “OR X 0”.

OR R*WR	ST X*WX	0	10	OR	X	0
------------	------------	---	----	----	---	---

4. Press the **WRT** key. The instruction you entered will be written to the programmable controller.

WRT

Changing the ST, AN, OR and DF to ST/, AN/, OR/ and DF/

When you change the ST, AN, OR and DF instructions to the ST/, AN/, OR/ and DF/ respectively, you do not have to enter the instruction all over again. Follow the procedure below for operation details.

On the following procedure, it is assumed that you change the ST instruction (ST X 0) to the ST/ instruction (ST/ X 0).

Procedure

1. Display the instruction you want to change to another one at the lower line of the LCD. Read the instruction from the programmable controller by specifying the address, or by pressing ▲ or ▼ key.
Refer to “Chapter 2” for operation details.

20	ST	X	0
----	----	---	---

2. Press the **NOT** key.
A slash(/) will be entered at the right of the instruction name.
The operand of the instruction will be cleared.

NOT
DT/Ld

20	ST/		
----	-----	--	--

3. Enter the operand for the instruction.
For example, press the **X** and **0** keys in that order to enter X0.

ST
X+WX

0

20	ST/	X	0
----	-----	---	---

4. Press the **WRT** key.
The new instruction will be written to the programmable controller.

WRT

20	ST/	X	0
21	OT	Y	10

Changing High Level Instructions

You can change the high level instruction which has been already entered to another instruction.

If you want to change an operand(s), you do not have to enter all the new instruction. Entering the new operand can change the instruction.

Notes on Changing the Instruction

When you change the instruction to the one whose number of steps is the larger, basically the addresses of the instructions below the new instruction will be shifted downward.

For example, when you change the MV instruction (five steps) to the DMV instruction (seven steps), the addresses of the instructions below the MV instruction will be shifted two.

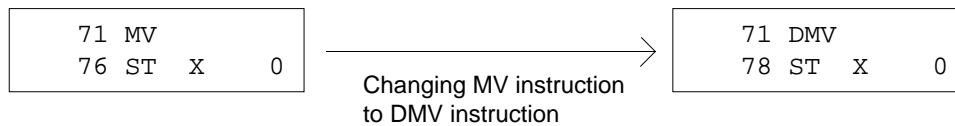

If the NOP instructions exist between the instruction you are going to change and the next instruction as shown below, NOP instructions as many as the number of steps exceeded resulting in the change will be replaced with the new instruction, and the addresses as many as the NOP instructions replaced may not be shifted downward.

For example, it is assumed that you change the MV instruction (five steps) to the DMV instruction (seven steps) and that three NOP instructions exist after the MV instruction. The MV instruction and the first and second NOP instructions will be replaced with the DMV instruction. The third NOP instruction will remain.

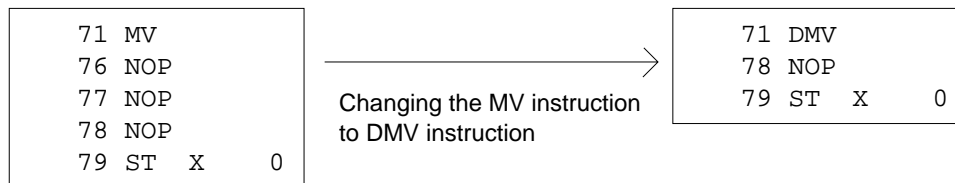

If you change the instruction to the one whose number of steps is the smaller, NOP instructions as many as the steps decreased resulting in the change, will be automatically entered after the new instruction.

For example, when you change the DMV instruction (seven steps) to the MV instruction (five steps), two NOP instructions will be entered after the MV instruction. The addresses of the instruction below the changed instruction will not be shifted.

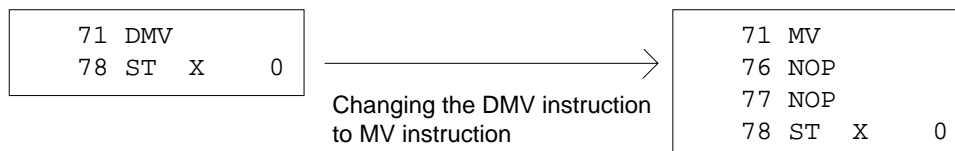

Changing Only the Operands of the High Level Instruction

If you change only operand of the high level instruction, follow the procedure below. Otherwise follow the procedure described in “Changing a High Level Instruction”.

On the following procedure, it is assumed that you change the first operand of MV instruction at address 71 from DT0 to DT1.

Procedure

1. Display the operand you want to change to another one at the lower line of the LCD. Read the instruction from the programmable controller by specifying the address, and display the operand by pressing the ▼ key. Or display the operand by pressing ▲ or ▼ key.
Refer to “Chapter 2” for operation details.

71	MV	.	
	DT		0

2. Enter the new operand.
For example, press the **DT** and **1** keys in that order to enter DT1.

NOT
DT/Ld

1

71	MV	.	
	DT		1

3. Press the **WRT** key.
The instruction will be written to the programmable controller together with the new operand.

WRT

71	MV		
76	ST	X	0

Changing a High Level Instruction

When you want to change a high level instruction name, you must enter the new instruction from the beginning. Refer to “4.1 Entering Instructions” to enter the new instruction.

On the following procedure, it is assumed that you change the RCL instruction to MV instruction.

Procedure

1. Display the instruction name to be changed at the lower line of the LCD. If the operand is displayed there, you cannot change the instruction.
Read the instruction from the programmable controller by specifying the address, or by pressing ▲ or ▼ key.
Refer to “Chapter 2” for operation details.

10	F123	RCL
----	------	-----

2. If you do not want to change the high level instruction type; the scan execution type(F) or the pulse execution type(P), skip this step and go to the step 3.

(HELP)
CLR

FN/P
FL

FN/P
FL

10	P
----	---

If you want to change the high level instruction type, press the **CLR** key to clear the existing instruction and press the **FN/P** key once or twice.

If you press the key once, you can enter a scan execution type instruction.

If you press the key twice, you can enter a pulse execution type instruction.

3. Enter the new instruction number.

If you skip the step 2, enter the number as the three-digit number.

For example, press the **0** key three times to enter “0” for the MV instruction.

0	10 F 0 MV
---	-----------

4. Press the **ENT** key.

The instruction will be registered.

ENT	10 MV ..
-----	----------

5. Enter the operands for the new instruction.

For example press the **DT** and **0** keys in that order to enter the first operand, DT0.

NOT DT/Ld	0	10 MV ..
		DT 0

Press the **ENT** key.

ENT	10 MV .
-----	---------

Press the **DT** and **1** keys in that order to enter the second operand. DT1.

NOT DT/Ld	1	10 MV .
		DT 1

6. When you finish entering all the operands, press the **WRT** key.

The new instruction will be written to the programmable controller.

If the number of steps for the instruction you changed to is larger than the number for the one you changed from, the addresses below the changed instruction will be shifted.

WRT	10 MV
	16 ST X 15

4.3 Inserting Instructions

You can insert instructions between instructions which have been already entered.

By inserting an instruction, the instructions which originally existed at the address will be shifted downward as many as the addresses the instruction inserted occupies. The instructions below the instruction will also be shifted.

For example, if you insert AN instruction at the address 1, the instruction which originally existed at the address 1 will be shifted to the address 2. Also, the following instructions will be shifted 1 address each, as show on the figures below.

0	ST	X	0
1	OT	Y	10
2	ST	X	2

The program originally exists.

1	OT	Y	10
---	----	---	----

Insert AN instruction at
address 1

1	AN	X	3
2	OT	Y	10

0	ST	X	0
1	AN	X	3
2	OT	Y	10
3	ST	X	2

The program after the insertion of the AN instruction.

If you are going to insert an instruction where a NOP instruction exists below, the NOP instruction will be replaced with the new instruction, or a part of the new instruction, and the addresses as many as the NOP instructions may not be shifted downward.

0	ST	X	1
1	AN	X	30
2	OR	R	2
3	NOP		
4	NOP		
5	OT	Y	20

Inserting an OR instruction
(OR R7) at the address 2

0	ST	X	1
1	AN	X	30
2	OR	R	7
3	OR	R	2
4	NOP		
5	OT	Y	20

Procedure

On the procedure, it is assumed that you insert an OR instruction (OR R 0) at the address 1 in the program shown on the right.

0	ST	X	1
1	AN	X	0
2	TM	X	10
K			50

1. Display the instruction at the address where you want to insert an instruction at the lower line of the LCD. Read the instruction from the programmable controller by specifying the address, or by pressing ▲ or ▼ key.
Refer to “Chapter 2” for operation details.

1	AN	X	0
---	----	---	---

2. Enter the instruction you want to insert.
For example, press the **AN**, **R** and **0** keys in that order to enter “OR R0”.

AN
Y•WY

OR
R•WR

0

1	OR	R	0
---	----	---	---

3. Press the **INST** key.
The instruction you just entered will be inserted at the address.
The instructions previously existed at the address will be shifted downward.

(DEL)
INST

1	OR	R	0
2	AN	X	0

0	ST	X	1
1	OR	R	0
2	AN	X	0
3	TM	X	10
K			50
6	ST	Y	0

4.4 Deleting Instructions

You can delete an instruction in the program stored on the programmable controller. If necessary, you can delete some instructions at a time by specifying the area to be deleted. Normally, after deleting instructions, the addresses will be shifted upward to fill the addresses where the instruction deleted was existed. However, if you do not want to shift the addresses, you can enter NOP instructions at the address where instructions are deleted.

Caution:

- Note that once you delete instructions, you can never recover the instructions. Immediately after key operations, the instruction you specified will be actually deleted from the program stored on the programmable controller.

Deleting Instructions With Shifting Addresses

By deleting an instruction, the instructions which exist below the instruction deleted will be shifted upward as much as the instruction deleted occupied.

You can delete more than one instruction by specifying the area to be deleted.

Notes:

- When you do not want shift the addresses, refer to “5.3 Deleting an Instruction without Shifting the Addresses.”

Deleting an Instruction

To delete a high level instruction, CT or TM instruction, make sure the instruction name is displayed at the lower of the LCD. Otherwise, you cannot operate deletion.

Procedure

On the procedure described below, it is assumed that you delete AN X 0 at the address 1 on the program shown on the right.

0	ST	X	1
1	AN	X	0
2	AN	Y	2
3	OR	R	3

1. Make sure that the instruction you want to delete is displayed at the lower line of the LCD. If you are going to delete a high level instruction, CT or TM instruction, make sure the instruction name is displayed at the lower of the LCD.

To display the target instruction at the lower line of the LCD, read the instruction by specifying the address, or if an instruction is already displayed, press ▲ or ▼ keys.

Refer to “Chapter 2” for operation details.

0	ST	X	1
1	AN	X	0

2. Press the **SHIFT** and **(DEL)** key in that order.
The instruction displayed at the lower line will be deleted.
The next instruction will be displayed the address where the instruction deleted was existed.

SHIFT
SC

(DEL)
INST

0	ST	X	1
1	AN	Y	2

Deleting Instructions

You can delete two or more instructions at the sequential addresses in the program stored on the programmable controller by specifying the area to be deleted.

To delete some pieces of instructions, the FP Programmer II must be operated from the initial status. So, before the operation, make sure the addresses you want to delete. Once you operated the deletion, the instructions deleted will never be recovered.

Procedure

The procedure described below assumes that you delete “AN X 0”, “AN Y 2” and “OR R 3” at the address 1 to 3 on the program shown on the right.

0	ST	X	1
1	AN	X	0
2	AN	Y	2
3	OR	R	3

1. Clear the LCD by pressing the **ACLR** key.

The FP Programmer II will become its initial status.

ACLR

**

2. Specify the head address of the instructions to be deleted.

Enter the head address number with numeric keys.

Press the **1** key to delete instructions from the address 1.

1

1

3. Press the **ENT** key to register the head address.

The instruction at the head address will be displayed at the upper line of the LCD.

ENT

1 AN X 0

4. Specify the end address of the instructions to be deleted.

Enter the end address number with the numeric keys.

Press the **3** key to delete up to the instruction at address 2.

3

1 AN X 0
3

5. Press the **READ** key to read the instructions from the programmable controller.

READ
▼

1 AN X 0
3 OR R 3

6. Press the **SHIFT** and **(DELT)** keys in that order.

The instructions you specified will be deleted.

The FP Programmer II will become the initial status.

SHIFT
SC

(DELT)
INST

**

Note:

- Check the program if the instructions specified were successfully deleted. Read the instruction at the address where the address was deleted.

0	ST	X	1
1	OT	Y	2

Deleting an Instruction Without Shifting Addresses

You can delete an instruction without shifting the addresses by replacing the instruction which you want to delete with the NOP instruction(s).

NOP instructions as many as the number of steps which the instruction deleted occupied will be entered at the addresses.

Deleting an Instruction

Procedure

On the procedure described below, it is assumed that you delete the AN instruction (AN X 0) and enter the NOP instruction instead, at the address 1 in the program shown on the right.

0	ST	X	1
1	AN	X	0
2	AN	Y	2
3	OR	R	3

1. Clear the LCD by pressing the **ACLR** key.
The FP Programmer II will become its initial status.
2. Enter the address number where the instruction you want to delete exists, with numeric keys. Press the **1** key to delete instructions at the address 1 without shifting the address.
3. Press the **READ** key to read the instruction at the address specified.
The instruction will be displayed at the lower line of the LCD.
4. Press the **SC** key to enter NOP instruction at the address specified.
5. Press the **1** key to enter the basic instruction code for NOP instruction.
The code "1" and instruction name "NOP" will appear at the next of the address.
6. Press the **SC** key again to register a NOP instruction at the address.
7. Press the **WRT** key to write the NOP instruction to the programmable controller.

ACLR

**

1

1

READ
▼

1 AN X 0

SHIFT
SC

1 AN X 0

1

1_ 1 NOP

SHIFT
SC

1 NOP

WRT

1 NOP
2 AN Y 2

Note:

- Check the program if the instruction specified were successfully deleted and NOP instruction(s) are entered instead. Read the instruction at the address where the address was deleted.

0	ST	X	1
1	NOP		

Deleting Instructions Without Shifting Addresses

You can delete two or more instructions at the sequential addresses in the program stored on the programmable controller by specifying the area to be deleted, without shifting addresses upward.

To delete some pieces of instructions, the FP Programmer II must be operated from the initial status. So, before the operation, make sure the addresses you want to delete. Once you operated the deletion, the instruction deleted will never be recovered.

Procedure

The procedure described below assumes that you delete “AN X 0”, “AN Y 2” and “OR R 3” at the address 1 to 3 on the program shown on the right, without shifting addresses.

0	ST	X	1
1	AN	X	0
2	AN	Y	2
3	OR	R	3

1. Clear the LCD by pressing the **ACLR** key.
The FP Programmer II will become its initial status.
2. Specify the head address of the instructions to be deleted.
Enter the head address number with numeric keys.
Press the **1** key to delete instructions from the address 1.
3. Press the **ENT** key to log the head address.
The instruction at the head address will be displayed at the upper line of the LCD.
4. Specify the end address of the instructions to be deleted.
Enter the end address number with the numeric keys.
Press the **3** key to delete up to the instruction at address 2.
5. Press the **READ** key to read the instruction from the programmable controller.
6. Press the **CLR** key.
The instructions at addresses specified will be replaced with the NOP instructions.
7. Press the **WRT** key to write the NOP instructions to the programmable controller.
The FP Programmer II will return to its initial status.

ACLR

**

1

1

ENT

1 AN X 0

3

1 AN X 0
3

READ

1 AN X 0
3 OR R 3

(HELP)
CLR

1 NOP
2 NOP

WRT

**

Note:

- Check the program if the instructions specified were successfully deleted and NOP instructions are entered instead. Read the instructions at the addresses where the instructions were deleted.

0	ST	X	1
1	NOP		

1	NOP
2	NOP

2	NOP
3	NOP

3	NOP		
4	OT	Y	2

CHAPTER 5

OP FUNCTIONS

5.1	Overviewing OP Functions	52
5.2	Selecting OP Functions	53
5.3	Clearing the Program Area and Hold AreasOP-0.....	55
5.4	Deleting NOP Instructions.....OP-1	56
5.5	Monitoring and Changing Word DataOP-2,OP-3,OP-8	57
5.6	Monitoring RelaysOP-7	60
5.7	Totally Check the ProgramOP-9.....	62
5.8	Forcing the Relays ON/OFFOP-10,OP-11	63
5.9	Monitoring and Changing Double Word DataOP-12	66
5.10	Changing the Edit Mode of Programmable Controller.....OP-14	70
5.11	Specifying the Link Unit NumberOP-20.....	72
5.12	Specifying the Route NumberOP-21	74
5.13	Changing the Mode of Programmable ControllerOP-30,OP-31,OP-32	75
5.14	Monitoring and Changing the System RegistersOP-50.....	77
5.15	Initializing System Registers SettingsOP-51	79
5.16	Allocating I/O NumbersOP-52.....	80
5.17	Selecting the Display LanguageOP-70.....	81
5.18	Adjusting the LCD ContrastOP-71	82
5.19	Entering the Registration Open/Closed State for the PasswordOP-72.....	83
5.20	Registering and Cancel the Password.....OP-73	84
5.21	Cancelling the Password (Forced Cancel).....OP-74	86
5.22	Transferring a Program to RAM from ROM.....OP-90.....	87
5.23	Transferring a Program between the Programmable Controller and the FP Programmer II.....OP-91	88
5.24	Transferring System Register Values between the Programmable Controller and the FP Programmer II.....OP-92	89
5.25	Transferring a Program to ROM from Internal RAMOP-99	90
5.26	Display the Self-diagnostic Error Codes on the FP Programmer II.....OP-110.....	91
5.27	Clearing Message Displayed on the FP Programmer II.....OP-111	92
5.28	Turning OFF the ERROR LED on the CPUOP-112.....	93

5.1 Overviewing OP Functions

The following table lists OP Functions. Overview the OP Functions to find what you can do.

OP Function	Display message	Description
OP-0	PROGRAM ALL CLR	Clears Program Area and Hold Areas.
OP-1	NOP ALL DELETE	Deletes all NOP instructions in the program.
OP-2, 3, 8	WORD DATA	Monitors and changes word data (register values).
OP-7	PLURAL POINT	Monitors relays (1 to 4 points).
OP-9	TOTAL CHECK	Totally checks a program.
OP-10, 11	(PRG)FORCE S/R (RUN)FORCE S/R	Turns ON/OFF (set/reset) relays forcedly.
OP-12	DOUBLE WORD DATA	Monitors and changes double-word data (two register values)
OP-14	PLC EDIT MODE	Changes the edit mode of programmable controller (RUN EDIT Mode / PROGRAM EDIT Mode). Operate when editing a program in the RUN Mode.
OP-20	LINK UNIT NO.	Specifies the Link Unit number. Operate when you conduct the remote programming.
OP-21	ROUTE NO	Specifies the Route number. Operate when you conduct the remote programming.
OP-30, 31, 32	PLC MODE	Changes the mode of programmable controller (PROG. Mode & RUN Mode)
OP-50	SYSTEM REG	Monitors/Sets system register values
OP-51	SYSTEM REG INIT	Initializes system registers
OP-52	I/O LAYOUT ENTRY	Allocates I/O Map
OP-70	LANGUAGE SELECT	Selects the display language (English/Japanese/Germany/Italy/French/Spanish)
OP-71	LCD CONTRAST	Adjusts the LCD contrast.
OP-72	PROT OPN=1,CLS=0	Set the programmable controller to the Registration Open/Close State (Password function)
OP-73	PASSWORD	Registers/Cancel the password
OP-74	PASSWORD INITIAL	Cancel the password forcedly.
OP-90	ROM,ICCARD > RAM	Transfers a program from Memory Unit/ROM/IC memory card to internal RAM.
OP-91	TRANSFER PROGRAM	Transfers a program between the FP Programmer II and the programmable controller
OP-92	TRANS. SYSTEM REG.	Transfers system register settings between the FP Programmer II and the programmable controller.
OP-99	RAM > ROM,ICCARD	Transfers a program from internal RAM to the Memory Unit/ROM/IC memory card.
OP-110	SELF CHECK	Displays the self-diagnostic error codes.
OP-111	MESSAGE CLEAR	Clears MSG instruction messages
OP-112	ERROR CLEAR	Turn OFF the ERROR LED on the programmable controller(CPU).

5.2 Selecting OP Functions

Before operating OP Functions, you must select OP number you want to operate, and register the number to the programmable controller to tell what operation you are going to do.

After the registration, you can operate the OP Function. How to operate OP Functions varies depending on each OP Function. So, refer to each section for operation details.

If you do not remember the OP number, you can display the OP number list on the FP Programmer II, and select from the list.

When you know the OP number you want to operate:

Procedure

1. Clear the LCD by pressing the **ACLR** key.
The FP Programmer II will become its initial status.
2. Press the **OP** key. “OP-” will appear on the LCD.
3. Enter an OP number.
For example, press the **1** key to operate the OP-1.
4. Press the **ENT** key. The corresponding OP function name with the OP number will be displayed on the screen.

ACLR

* *

(-) OP

OP-

1

OP- 1

ENT

OP- 1
NOP ALL DELETE

When you do not know the OP number you want to operate:

Procedure

1. Clear the LCD by pressing the **ACLR** key.
The FP Programmer II will become its initial status.
2. Press the **OP** key. “OP-” will appear on the LCD.
3. Press the **SHIFT** key. An under bar will be displayed at the next of the “OP”.
4. Press the **(HELP)** key to list the OP numbers.
The word “HELP” will be displayed with the OP number and its name.
The list will be displayed from the OP-0.

ACLR

* *

(-) OP

OP-

SHIFT SC

OP_

(HELP) CLR

OP_ 0 HELP
PROGRAM ALL CLR

5.2 Selecting OP Functions

5. Using the ▼ or ▲ key, search for the OP number you want to operate.

Press the ▼ key to increment the OP number.

Press the ▲ key to decrement the OP number.

For example, press the ▼ key once. The OP-1 will be displayed on the LCD.

READ
▼

OP_ 1 HELP
NOP ALL DELETE

6. When you find the OP number you want to operate, press the **ENT** key to register the number.
The word “HELP” will disappear.

ENT

OP_ 1
NOP ALL DELETE

5.3 Clearing the Program Area and Hold Areas

OP-0

The OP-0 clears all the data stored in the memory of the programmable controller (RAM), and turns all the Hold Area OFF.

You must operate the OP-0 when you newly create a program.

Procedure

1. Clear the LCD by pressing the **ACLR** key.

The FP Programmer II will become its initial status.

ACLR

**

2. Press the **OP, 0** and **ENT** keys in that order to operate the OP-0.

(-)
OP

0

ENT

OP- 0
PROGRAM ALL CLR

3. Press the **SHIFT** key. An under bar will be displayed at the next of the "OP".

SHIFT
SCOP- 0
PROGRAM ALL CLR

4. Press the **(DELT)** keys. If the Program and Hold Area are successfully cleared, the FP Programmer II returns to its initial status.

(HELP)
CLR

**

5.4 Deleting NOP Instructions

OP-1

The OP-1 deletes all the NOP instructions written in the program stored in the memory of the programmable controller (RAM). Deleting NOP instructions can decrease the total number of steps which makes processing time of the program smaller.

Note:

- The addresses below a NOP instruction will be shifted after deleting the NOP instruction.

Procedure

1. Clear the LCD by pressing the **ACLR** key.
The FP Programmer II will become its initial status.

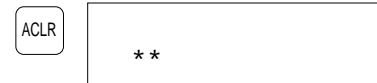

2. Press the **OP**, **1** and **ENT** keys in that order to operate the OP-1.

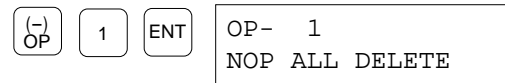

3. Press the **SHIFT** key. An under bar will be displayed at the next of the "OP".

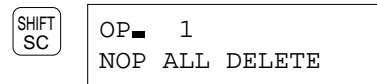

4. Press the **(DEL)** keys. If the NOP instructions are successfully cleared, the FP Programmer II returns to its initial status.

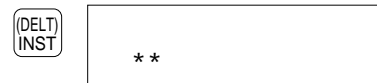

5.5 Monitoring and Changing Word Data

OP-2, OP-3, OP-8

OP-2, OP-3 and OP-8 perform the same functions.

You can monitor/change the word data (register value) stored in the registers, WX, WY, WR, WL, FL, DT, LD, IX, IY, SV and EV.

The word data can be displayed in decimal, hexadecimal or binary. As the default setting, the data will be displayed in decimal.

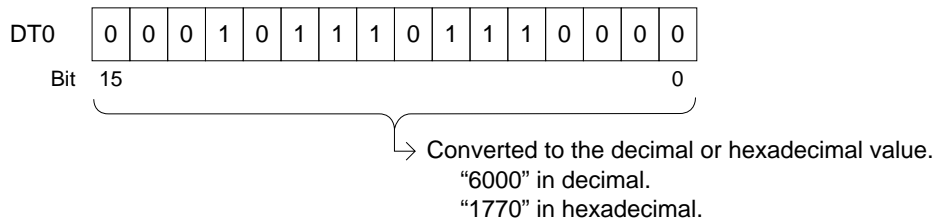

When you monitor word data in binary, the data will be displayed as follows.

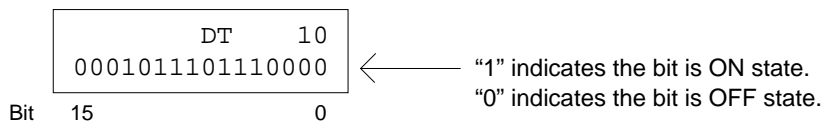

If necessary, you can change the word data. You can enter it in decimal or hexadecimal. To change the value, first you display (monitor) the value on the FP Programmer II, then change the value to the one you want.

If you want to monitor/change more than one register value, you can increase/decrease the system register number using the ▼ / ▲ keys. Every time you press the key, the number will increase/decrease by one.

Note:

- If you want to monitor/change register value as double-word data, refer to "5.9 Monitoring and Changing Double Word Data".

Monitoring Word Data

Procedure

On the procedure, it is assumed that you monitor the word data of WR0 with the OP-8.

1. Clear the LCD by pressing the **ACLR** key.
The FP Programmer II will become its initial status.

ACLR

**

2. Press the **OP, 8** and **ENT** keys in that order to operate the OP-8.

(-)
OP

8

ENT

OP- 8
WORD DATA

- Enter the register name whose value you want to monitor, by pressing **WX, WY, WL, FL, DT, Ld, IX, IY, SV, EV**. The **DT/Ld** and **IX/IY** keys toggle **DT** and **Ld**, and **IX** and **IY** respectively. If you press a wrong key, press the desired one again. FP Programmer II will overwrite the new one.



Press the **WR** key to select "WR".

- Enter the register number. Press the **0** key to monitor WR0.



- Press the **▼** key. The register value will be displayed in decimal as the default setting. "K" indicates the value is represented in decimal.

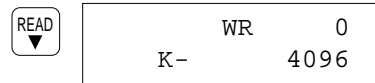

To monitor the data in hexadecimal or binary, refer to "Changing the Representation of Register Value" section below.

To change the value, refer to "Changing the Register Value" section below.

To monitor/change the another register value, refer to "Continuously Monitoring Other Register Values" section below.

- Press the **ACLR** key to end the OP-8 operation. The FP Programmer II will return to its initial status.

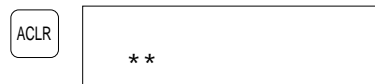

Changing the Representation of Register Value

When you want to display the value in hexadecimal

Press the **K/H** key. The register value will be displayed in hexadecimal.

The **K/H** key toggles the representation to decimal(K) and hexadecimal(H). Every time you press the key, the representation will be changed to the other one.

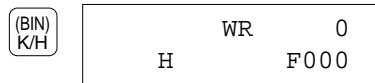

When you want to display the value in binary:

Press the **SHIFT** and **(BIN)** keys in that order. The register value will be displayed in binary.

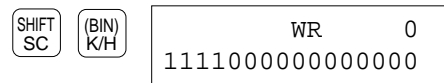

Continuously Monitoring Other Register Values

Press the **▼** key to increase the register number.

Press the **▲** key to decrease the register number.

Every time you press the key, the register number will increase/decrease by one.

To monitor another type of register, clear the LCD by pressing the **CLR** key twice.

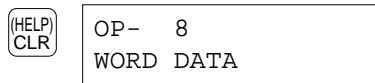

Then follow the procedure from the step 3 above.

Changing the Word Data(Register Value)

Caution:

- Before the operation, make sure that the operation result does not damage any other devices. If there is any possibility, operate the FP Programmer II in the PROG. Mode. To make the programmable controller the PROG. Mode, refer to “5.13 Changing the Mode of Programmable Controller”.

Procedure

On the procedure, it is assumed that you change the word data of WR10 to 200 in decimal representation.

- By following the procedure described in “Monitoring Word Data” section, display the register value you want to change.

	WR	10
K		0

- Press the **CLR** key to clear the value.

(HELP)
CLR

	WR	10

- Select in which representation you enter the value.

Press **K/H** key once to enter the value in decimal. “K” is displayed on the lower line of the LCD.

(BIN)
K/H

	WR	10
K		

Press **K/H** key twice to enter the value in hexadecimal. “H” is displayed on the lower line of the LCD.

(BIN)
K/H

(BIN)
K/H

	WR	10
H		

- Enter the value in the representation you have selected in step 7.

When you have selected the decimal representation, press **2**, **0** and **0** keys in that order to enter “200”.

2

0

0

	WR	10
K		200

When you have selected the hexadecimal representation, press **C** and **8** keys in that order to enter “C8”.

=
C

8

	WR	10
H		C8

Note:

- To enter a negative value in decimal, press **K/H** key once to enter decimal value, then press **SHIFT** and **(-)** keys in that order. A minus sign will appear at the next of the word “K” as shown below.

(BIN)
K/H

SHIFT
SC

(-)
OP

	WR	10
K-		

- Press the **WRT** key to write the value you entered to the programmable controller. Monitoring the word data will start again.

WRT

5.6 Monitoring Relays

You can monitor the status of relays, X, Y, R, L, T and C.
 You can monitor a maximum of 4 points of relays at the same time.

Relays you entered for monitoring will be displayed as follows:

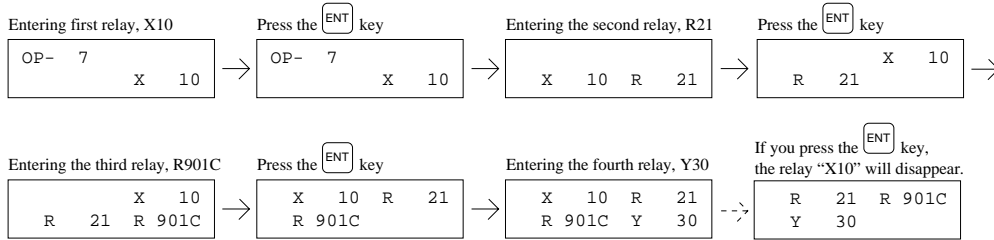

Procedure

On the procedure, it is assumed that you monitor the relay X0, R1, RC and Y3.

1. Clear the LCD by pressing the **ACLR** key.
The FP Programmer II will become its initial status.
2. Press the **OP, 7** and **ENT** keys in that order to operate the OP-7.
3. Enter the relay name you want to monitor, by pressing **X, Y, R, L, T** or **C** key.
Press the **X** key to select "X".
4. Enter the relay number.
Press the **0** key in that order to monitor the relay "X0".
5. When you want to monitor another relay, press the **ENT** key.
On the LCD, the relay entered will be moved to the right.
Then, repeat the step 3 and 4 to enter another relay name and number.

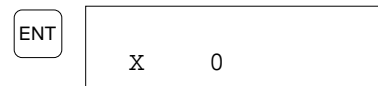
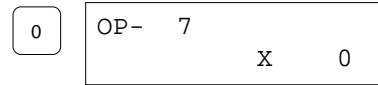
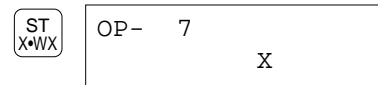
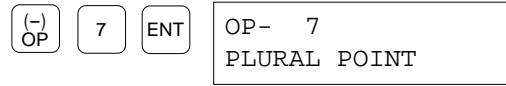
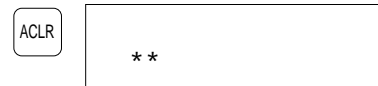

Press the **R** and **1** keys in that order to monitor the relay "R1".

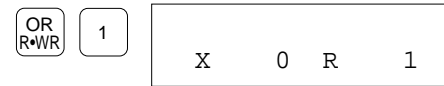

You can repeat step 5 twice to enter third and forth relays.

Press the **ENT, R** and **C** keys in that order to monitor the relay "RC".

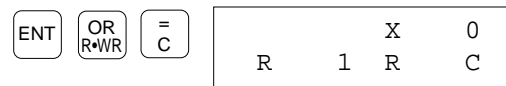

Press the **ENT, Y** and **3** keys in that order to monitor the relay "Y3".

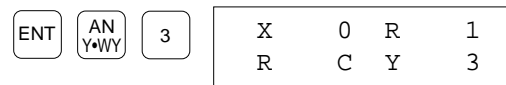

6. Press the **WRT** key to start monitoring these relays.

When the relay is ON state, the column before the relay will be highlighted as shown on the right.
On the figure, X0 and Y3 is in ON state.

WRT	■ X	0	R	1
	R	C	■ Y	3

If you want to monitor another relay, refer to “Monitoring Other Relays” section described below.

7. Press the **ACLR** key to end the OP-7 operation.
The FP Programmer II will return to its initial status.

ACLR	* *			
------	-----	--	--	--

Monitoring Other Relays

You can change the fourth relay to another relay during monitoring.
If you enter the **ENT** key after entering a new fourth relay, the relay will be shifted to the left and first relay will disappear.

On the procedure, it is assumed that you newly monitor the relay R2 and R3.

Procedure

1. Press the **SRC** key to stop monitoring.

SRC ▲	X	0	R	1
	R	C	Y	3

2. Press the **CLR** key. The fourth relay will be cleared.

(HELP) CLR	X	0	R	3
	R	C		

3. Enter a new relay name and the number.
Press the **R** and **2** keys in that order to monitor R2.

OR R•WR	2	X	0	R	1
		R	C	R	2

4. Press the **ENT** key to enter another new relay name and the number.

ENT	R	1	R	C
	R	2		

5. Enter a new relay name and the number.
Press the **R** and **3** keys in that order to monitor R3.

OR R•WR	3	R	1	R	C
		R	2	R	3

6. Press the **▼** key to start monitoring again.

READ ▼	R	1	R	C
	R	2	R	3

Note:

- If you press **CLR** key twice, the FP Programmer II returns the status shown step 2.

5.7 Totally Check the Program

OP-9

The OP-9 performs a total check of the program stored in the internal RAM.

Errors such as syntax error, duplicated output error in the program are checked. When any error is detected, the FP Programmer II will display the error message. Refer to “Appendix A Error Messages” to find the action you should take, and correct the error.

Before the operation, make sure that the programmable controller is in the PROG. Mode.

Procedure

1. Clear the LCD by pressing the **ACLR** key.
The FP Programmer II will become its initial status.

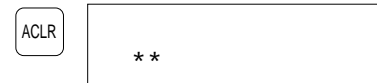

2. Press the **OP, 9** and **ENT** keys in that order to operate the OP-9.

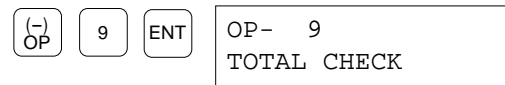

3. Press the **▼** key. The FP Programmer II will start checking the program from the first address.



When no error is detected, the FP Programmer II will return to its initial status. Two asterisks(**) will be displayed on the LCD.



When an error is detected, the address subjected to the error and error message will be displayed on the LCD. On the left figure, the error message “54PAIR” indicates an “PAIR” error was detected at the address 54.

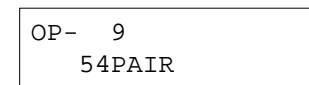

When you want to check another error, press the **▼** key again. The following error address and message will appear at the lower line and the error message previously detected will be shifted to the upper line. The message at the upper line will disappear.

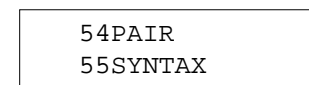

When no error was detected any more, the FP Programmer II will return to its initial status.

Note:

- When you check the program for FP10 or FP10S, it may take some times to check the program.

5.8 Forcing the Relays ON/OFF

OP-10, OP-11

Caution:

- Before the operation, make sure that the operation result does not damage any other devices. If there is any possibility, operate in the PROG. Mode.

The OP-10 and OP-11 perform the forced input/output operation. There is no difference in the performance. Depending on the mode of programmable controller, the relays you can turn ON/OFF forcedly and how to cancel the forced state will vary.

In the PROG. Mode, you can forcedly turn ON/OFF the relays, Y, R and L.

The forced state will be kept until the **ACLR** key is pressed toward the relays which are set to the “NON-HOLD”. The relays which are set to the “HOLD” will keep forced state even though the **ACLR** key is pressed.

In the RUN Mode, you can forcedly turn ON/OFF the relays, X, Y, R, L, T and C, with regardless of the execution of the program.

The forced state will be cancelled when the **READ**, **SRC** or **ACLR** key is pressed.

Note:

- When you end the OP-10 operation, you will press the **ACLR** key. So, when you end the operation, the forced state will be cancelled except the relays on the HOLD area in PROG. Mode.

With regardless of the mode of programmable controller, the forced state will be cancelled when you change the mode of programmable controller during the OP-10 operation.

If you remove the FP Programmer II during the OP-10 operation, the forced state will be cancelled when you connect it, then register OP-10 after connecting the programmer again, that is, when you press the **ENT** key after you enter OP number, 10.

Procedure

On the procedure, it is assumed that you turn ON the “YA” forcedly with the OP-10.

1. Clear the LCD by pressing the **ACLR** key.
The FP Programmer II will become its initial status.

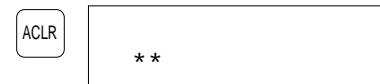

2. Press the **OP**, **1**, **0** and **ENT** keys in that order to operate the OP-10. Depending on the mode of programmable controller, the FP Programmer II displays either screen.

When the programmable controller is in the PROG. Mode

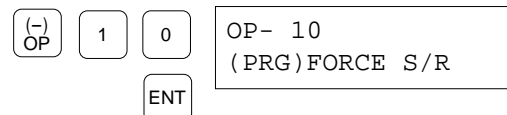

When the programmable controller is in the RUN Mode

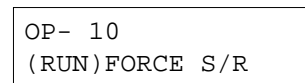

3. Enter the relay name you want to turn ON/OFF forcedly.
 When “(PRG)” is displayed, press one of **Y**, **R** and **L** keys.
 When “(RUN)” is displayed, press one of **X**, **Y**, **R**, **L**, **T** and **C** keys.



Press the **Y** key to turn ON the relay, Y.

4. Enter the relay number.

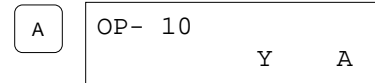

Press the **A** keys to turn ON the relay YA.

5. Press the **ENT** key. Monitoring the relay will start.
 If the relay is ON state, the lower line and rightmost column on the LCD is reversed. If it is OFF state, it is not reversed.



ON state

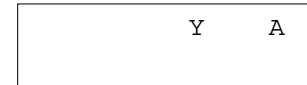

OFF state

6. Press **1** key to turn ON the relay, or press **0** key to turn OFF the relay.



Continuously you can turn ON/OFF another relay. Refer to the section “Changing the relay name/number” described below for details.

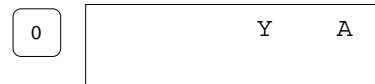

7. To end the OP-10 operation, press **CLR** key twice.
 The name of OP-10 will be displayed on the LCD.

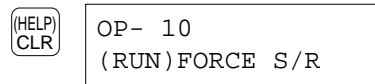

8. Press the **ACLR** key. The FP Programmer II will return to the initial status.

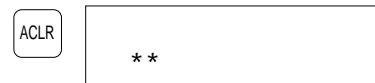

Notes:

- When you press the **ACLR** key, the forced state will be cleared, except the HOLD-AREA in the PROG. Mode.
- If you change the mode of programmable controller during the OP-10 operation, the LCD will display the name of OP-10.

Changing the Relay Name/Number

You can continuously turn ON/OFF another relay forcedly. If you turn ON/OFF the same type of relay, you change only relay number. If you turn ON/OFF the another type of relay, you change relay name and number. When you change the relay name, you must enter the relay number even though the number is the same as the old one.

Changing only relay number

If you want to change only relay number without changing the relay name, follow the procedure below.

On the procedure, it is assumed that you change the relay “YA” to “YB”.

Procedure

- Press the ▲ key or ▼ key.
The relay number will decrease by one every time you press the ▲ key.
The relay number will increase by one every time you press the ▼ key.
Press ▼ key once to display YB.

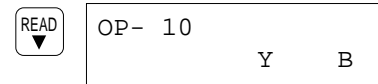

- Press the **ENT** key.

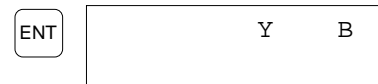

- Repeat steps from the step 5 on the previous page.

Changing relay name

If you want to change relay name, follow the procedure below.

On the procedure, it is assumed that you change the relay “YA” to “R1”.

Procedure

- Press the **CLR** key. The LCD will change as follows.

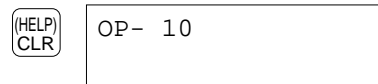

- Enter the relay name and number.
Press **R** and **1** in that order to turn ON/OFF the relay, R1.

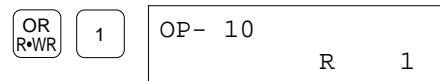

- Press the **ENT** key.



- Repeat steps from the step 5 on the previous page.

5.9 Monitoring and Changing Double Word Data

OP-12

You can monitor the double-word data (32 bit data) stored in the two registers in sequence. The target registers to be monitor are WX, WY, WR, WL, FL, DT and LD. Specifying an address, you can monitor the data which stored in the address specified and its next address.

The double-word data can be displayed in decimal, hexadecimal or binary. As the default setting, the data will be displayed in decimal.

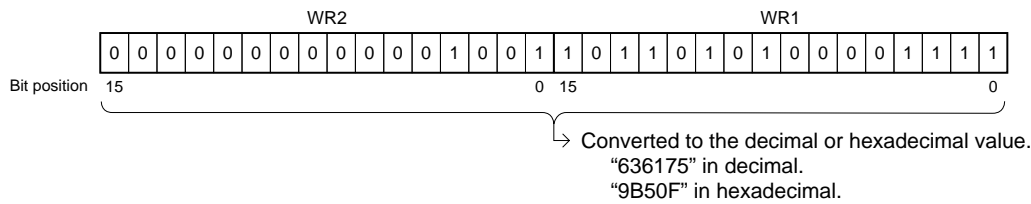

When you specify WR1 in the OP-12 operation

When you monitor word data in binary:

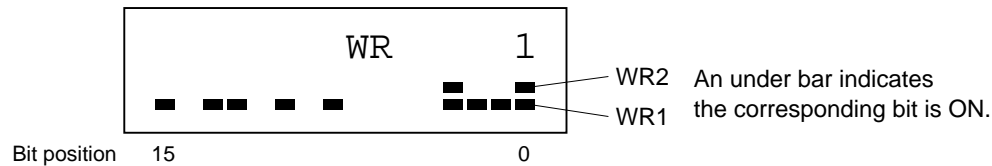

If necessary, you can change the double-word data. You can enter it in decimal or hexadecimal. To change the value, first you display (monitor) the value on the FP Programmer II, then change the value to the one you want.

If you want to monitor/change more than one piece of double-word data, you can increase/decrease the register number using the ▼ / ▲ keys. Every time you press the key, the number will increase/decrease by one.

Monitoring Double-Word (32-bit) Data (Two Register Values)

Procedure

On the procedure, it is assumed that you monitor the double-word data of WR1 and WR2.

1. Clear the LCD by pressing the **ACLR** key.
The FP Programmer II will become its initial status.



2. Press the **OP**, **1**, **2**, and **ENT** keys in that order to operate the OP-12.

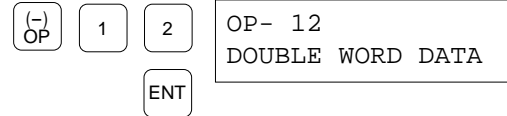

3. Enter the register name whose value you want to monitor, by pressing **WX**, **WY**, **WR**, **WL**, **FL**, **DT**, **Ld**.
The **DT/Ld** key toggle DT and LD.
If you press a wrong key, press the desired one again.
FP Programmer II will overwritten new one.

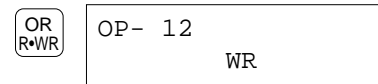

Press the **WR** key to select "WR".

4. Enter the register number.
Press the **1** key to monitor WR1 and WR2.

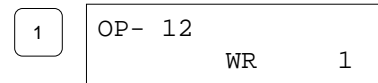

5. Press the **READ** key.
The double-word data stored in WR1 and WR2 will be displayed in decimal.

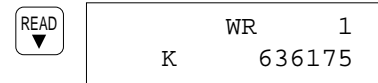

To monitor the data in hexadecimal or binary, refer to "Changing the Representation of Double-Word Data" section on the next page.

To change the value, refer to "Changing the Double-Word Data" section on the next page.

To monitor/change the another double word data, refer to "Continuously Monitoring Other Double-Word Data" section on the next page.

6. Press the **ACLR** key to end the OP-8 operation.
The FP Programmer II will return to its initial status.

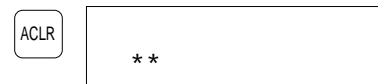

Changing the Representation of Double Word Data

When you want to display the value in hexadecimal:

Press the **K/H** key. The register value will be displayed in hexadecimal.

The **K/H** key toggles the representation to decimal(K) and hexadecimal(H). Every time you press the key, the representation will be changed to the other one.

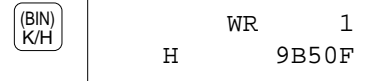

When you want to display the value in binary:

Press the **SHIFT** and **(BIN)** keys in that order. The register value will be displayed in binary.



Continuously Monitoring Other Register Values

Press the **▼** key to increase the register number.

Press the **▲** key to decrease the register number.

Every time you press the key, the register number will increase/decrease by one.

For example, press **▼** key when WR2 is displayed on the LCD

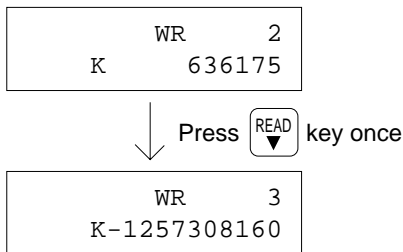

To monitor another type of register values, clear the LCD by pressing **CLR** key twice.

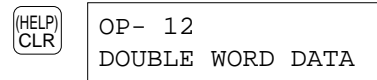

Then follow the procedure from the step 3 on the previous page.

Changing the Double-Word Data

Caution:

- Before the operation, make sure that the operation result does not damage any other devices. If there is any possibility, operate the FP Programmer II in the PROG. Mode. To make the programmable controller the PROG. Mode, refer to “5.13 Changing the Mode of Programmable Controller”.

Procedure

On the procedure, it is assumed that you change the double-word data of WR2 and WR3 to “100” in decimal representation.

1. By following the procedure described in “Monitoring Double-Word Data” section, display the register value you want to change.

	WR	2
K		636175

2. Press the **CLR** key to clear the value.

(HELP)
CLR

	WR	2

3. Select in which representation you enter the value.

Press **K/H** key once to enter the value in decimal. “K” is displayed on the lower line of the LCD.

(BIN)
K/H

	WR	2
K		

Press **K/H** key again to enter the value in hexadecimal. “H” is displayed on the lower line of the LCD.

(BIN)
K/H

	WR	2
H		

4. Enter the value in the representation you have selected in step 3.

When you have selected the decimal representation, press **1**, **0** and **0** keys in that order to enter “100”.

1

0

0

	WR	10
K		100

When you have selected the hexadecimal representation, press **6** and **4** keys in that order to enter “64”.

6

4

	WR	10
H		64

Note:

- To enter a negative value in decimal, press **K/H** key once to enter decimal value, then press **SHIFT** and **(-)** keys in that order. A minus sign will appear at the next of the word “K” as shown below.

(BIN)
K/H

SHIFT
SC

(-)
OP

	WR	10
K-		

5. Press the **WRT** key to write the value you entered to the programmable controller.
Monitoring the word data will start again.

WRT

5.10 Changing the Edit Mode of Programmable Controller OP-14

The FP Programmer II has two modes, RUN EDIT Mode and PROGRAM EDIT Mode for the edit mode of programmable controller. When it is in the RUN EDIT Mode, you can edit a program even if the programmable controller is in the RUN Mode. You can write/insert/delete a part of program in the programmable controller in the RUN Mode. However, since editing the program in the RUN Mode is very risky, carefully read the Program editing in the RUN mode section in your programmable controller technical manual or programming manual before operation.

In the normal operation, operate in the edit mode of programmable controller under the PROG. Mode. As the default setting, the FP Programmer II will go to PROGRAM EDIT Mode. So, only when you want to edit the program in the RUN Mode, change the edit mode of programmable controller to the RUN EDIT Mode.

If you set the edit mode of programmable controller to the RUN EDIT Mode when the programmable controller is in the PROG. Mode, the programmable controller will operate in the PROG. Mode. The RUN EDIT Mode under the PROG. Mode does not affect the performance in the programmable controller. However, if you tried to operate the FP Programmer II in the PROGRAM EDIT Mode when the programmable controller is in the RUN Mode, the “PLC MODE ERROR (NO. 63)” will occur with beep sound. To stop beeping, press the **ACLR** key. The edit mode of programmable controller will stay in the PROG EDIT Mode.

Note:

- For the details of edit mode of programmable controller, refer to your programmable controller technical manual or programming manual.

Procedure

1. Clear the LCD by pressing the **ACLR** key.
The FP Programmer II will become its initial status.

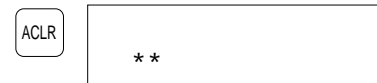

2. Press the **OP**, **1**, **4** and **ENT** keys in that order to operate the OP-14.

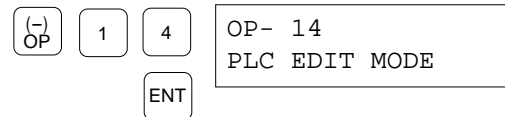

3. Press the **READ** key. The current PLC EDIT Mode will be displayed on the LCD.
When the programmable controller is in the PROGRAM EDIT Mode, “PRG EDIT (0)” is displayed on the LCD.

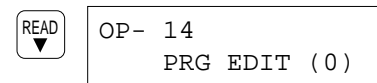

When the programmable controller is in the RUN EDIT Mode, “RUN EDIT (1)” is displayed on the LCD.

4. To change the mode to RUN EDIT Mode, press **1** key. The display will be changed to “RUN EDIT (1)”.

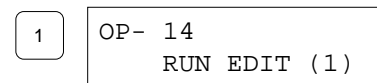

To change the mode to PROGRAM EDIT Mode, press **0** key.
The display will be changed to “PRG EDIT (0)”.

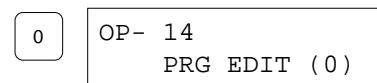

5. Press **WRT** key. The programmable controller will go to the edit mode you selected.

A rectangular button with rounded corners containing the text "WRT".

6. Press **ACLR** key to end the OP-14 operation.
The FP Programmer II will return to its initial status.

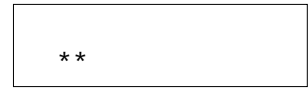
A rectangular button with rounded corners containing the text "ACLR".

Note:

- The setting will valid until you change the mode again while the FP Programmer II is ON. When you turn OFF the FP Programmer II, the setting will be cleared.

5.11 Specifying the Link Unit Number

OP-20

You can operate a remote programmable controller linked with the Link Units as shown in the figure below. (Remote Programming Function)

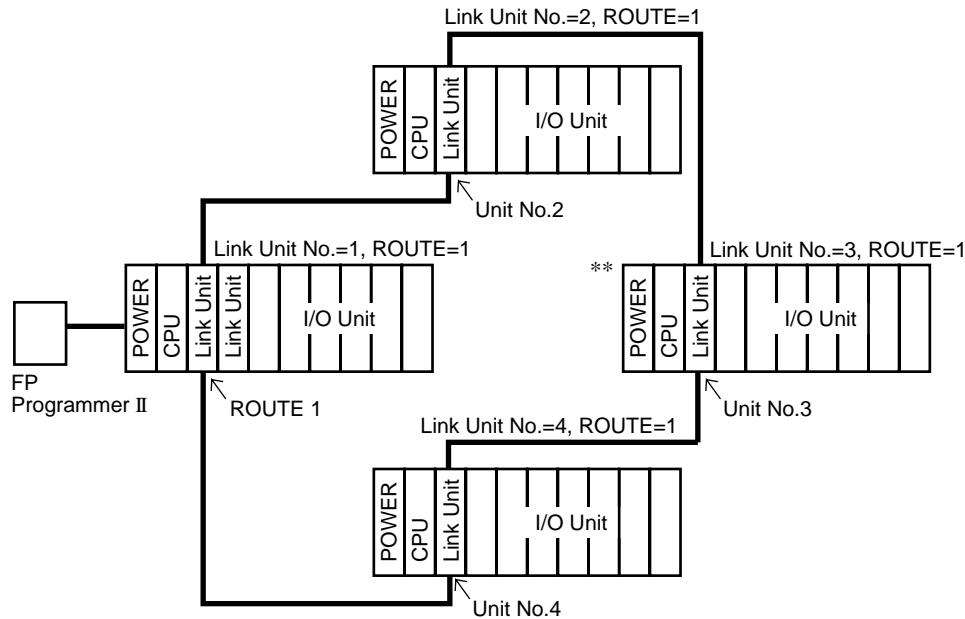

To operate a remote programmable controller, you must specify the route number which the programmable controller belongs and the Link Unit number. From the programmable controller where the FP Programmer II is connected, the programmable controller marked ** belongs the network of route 1 and its Link Unit number is 3. Each Link Unit number in the same network must be unique, so from the programmable controller (Link Unit number 1) with which the programmer connected, the data at the remote programmable controller will be edited.

With the OP-20, you can specify the Link Unit number.

Specify “0” when you do not configure a network, nor operate the remote programming.

The Link Unit number “0” is specified as the default settings, if you don’t configure a network using Link Units, you don not have to operate OP-20.

Before the OP-20 operation, first operate OP-21 to specify the route number.

Refer to “5.12 Specifying the Route Number” for operation details.

Procedure

1. Clear the LCD by pressing the **ACLR** key.
The FP Programmer II will become its initial status.

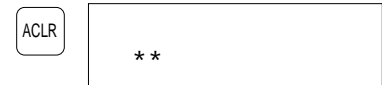

2. Press the **OP**, **2**, **0** and **ENT** keys in that order to operate the OP-20.

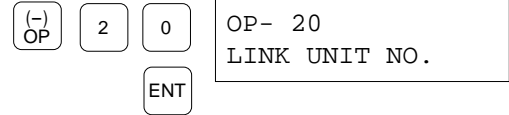

3. Press the **READ** key. The Link Unit number currently specified will be displayed on the LCD.

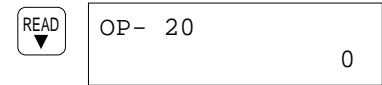

4. Enter the Link Unit number using numeric keys.
For example, press **3** to specify the Link Unit number 3.

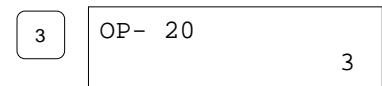

5. Press the **WRT** key. The Link Unit number specified will be set to the programmable controller, and the FP Programmer II will return to its initial status.

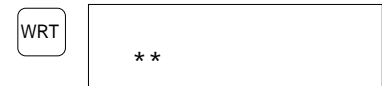

If you have specified the number other than 0, even though you do not configure a network, the error message "NO LINK NO. !50" will be displayed on the LCD with beep sounds. To stop sounding alarm, press the **CLR** key. The FP Programmer II will be return the status at step 2. The Link Unit number setting stays the one before operation.

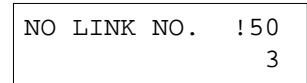

Note:

- The setting will valid until you change the unit number again while the FP Programmer II is ON. When you turn OFF the FP Programmer II, the setting will be cleared.

5.12 Specifying the Route Number

OP-21

You can operate a remote programmable controller linked with the Link Units.

To operate a remote programmable controller, you must specify the route number which the programmable controller belongs and the Link Unit number. With the OP-21, you can specify the route number.

Specify “0” when you do not configure a network nor operate the remote programming. As the default setting, the route number “0” is specified.

Form the closest to the CPU, it is called route 1, route 2 and route 3.

Note:

- Refer to “5.11 Specifying the Link Unit Number” to specify the Link Unit number.

Procedure

- Clear the LCD by pressing the **ACLR** key.
The FP Programmer II will become its initial status.
- Press the **OP**, **2**, **1** and **ENT** keys in that order to operate the OP-21.
- Press the **READ** key. The Route number currently specified will be displayed on the LCD.
- Enter the Route number using numeric keys.
For example, press **1** to specify the route number 1.
- Press the **WRT** key. The route number specified will be set to the programmable controller, and the FP Programmer II will return to its initial status.

ACLR

**

(-) OP 2 1 ENT

OP -21
ROUTE NO

READ ▼

OP -21 0

1

OP -21 1

WRT

**

DATA ERR !61
1

If you have specified a number which is not applicable, the error message “DATA ERR !61” will be displayed on the LCD with beep sounds. To stop beeping, press the **CLR** key.

The FP Programmer II will be return the status at step 2.

The Link Unit number setting stays the one before operation.

Note:

- The setting will valid until you change the route number again unless you change the programmable controller with which the FP Programmer II is connected.
The route number information will be saved in the programmable controller connected with the FP Programmer II.

5.13 Changing the Mode of Programmable Controller

OP-30, OP-31, OP-32

Note:

- The OP-30, OP-31 and OP-32 perform the same function. There is no difference between them.

Using the OP-30, OP-31 or OP-32, you can change the mode of programmable controller from the FP Programmer II.

The programmable controller has three modes, PROG Mode, RUN Mode and REMOTE Mode, and the mode can be set with the Mode Selector Switch on the front panel of the CPU. If the mode of programmable controller is set to the REMOTE Mode on the CPU, you can change the mode from the FP Programmer II to the RUN Mode (REMOTE RUN) or PROG. (REMOTE PROG.) Mode, using the OP-30, OP-31 or OP-32.

Note:

- For details of mode of programmable controller, refer to the Hardware Manual of your programmable controller.

Procedure

On the procedure, it is assumed that you change the mode of programmable controller with the OP-30.

1. Clear the LCD by pressing the **ACLR** key.

The FP Programmer II will become its initial status.

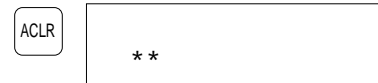

2. Press the **OP, 3, 0** and **ENT** keys in that order to operate the OP-30.

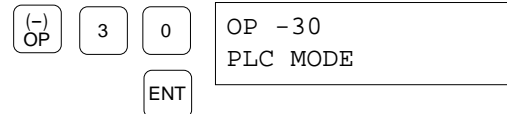

3. Press the **READ** key. The mode of programmable controller which the programmable controller is currently in will be displayed on the LCD.

Refer to the table to see which mode the programmable controller is currently in.

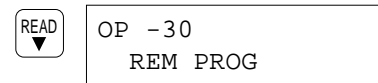

Mode of programmable controller	Indication
REMOTE PROG. Mode	REM PROG
REMOTE RUN Mode	REM RUN
PROG. Mode	PROG
RUN Mode	RUN

4. Press the **0** key to change the mode of programmable controller to **PROG.** Mode from **RUN** Mode.

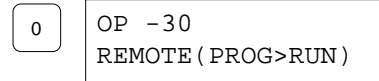

Press the **1** key to change the mode of programmable controller to **RUN** Mode from **PROG.** Mode.

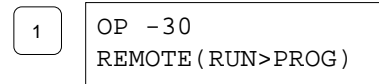

Note:

- You can change the mode of programmable controller only when the programmable controller is in the **REMOTE** Mode. So, when “**PROG**” or “**RUN**” is displayed on the programmable controller, you cannot change the mode from the **FP Programmer II**.

5. Press the **WRT** key. The mode of programmable controller will be changed to the one you specified.



If the programmable controller is not in the **REMOTE** Mode, the error message “**PLC MODE ERR !63**” will be displayed on the **LCD** with beep sounds. To stop beeping press the **CLR** key. The **FP Programmer II** will be return the status at step 2. The mode of programmable controller stays the one before operation.

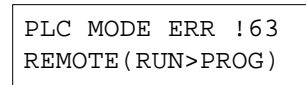

6. Press the **▼** key to check if the mode is changed the one specified.

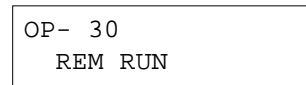

7. Press the **ACLR** key to end the **OP-30** operation. The **FP Programmer II** will return to its initial status.



5.14 Monitoring and Changing the System Registers OP-50

You can monitor the system registers values, and if you want, you can change the values using the OP-50.

You can monitor/change the system register value in decimal or hexadecimal. As the default, the value will be displayed in decimal.

If you want to monitor/change more than one register value, you can increase/decrease the system register number using the ▼ / ▲ keys. Every time you press the key, the number will increase/decrease by one.

To change the system register value, the programmable controller must be in the PROG. Mode. To check the mode of programmable controller currently set, operate OP-30, OP-31 or OP-32. You can also change the mode of programmable controller with them. Refer to “6-13 Changing the PLC Mode” for operation details.

Note:

- For details of system registers, refer to the Hardware Manual or Programming Manual of your programmable controller.

Monitoring System Register Values

Procedure

On the procedure, it is assumed that you monitor the system register No.5.

1. Clear the LCD by pressing the **ACLR** key.

The FP Programmer II will become its initial status.

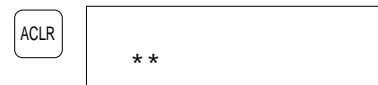

2. Press the **OP**, **5**, **0** and **ENT** keys in that order to operate the OP-50.

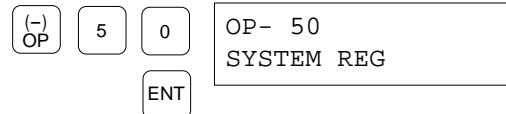

3. Enter the system register number.

Press the **5** to monitor system register No.5.

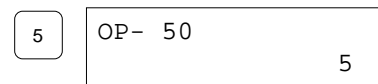

4. Press the **READ** key.

The register value will be displayed in decimal at the lower line of the LCD.

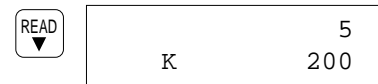

To display the value in the hexadecimal, press the **K/H** key. The **K/H** key toggles the value representation to decimal and hexadecimal.

To change the value, refer to “Changing the System Register Value” section on the next page.

To monitor/change the another system register value, refer to “Continuously Monitoring Other System Register Values” section on the next page.

5. Press the **ACLR** key to end the OP-50 operation.

The FP Programmer II will return to its initial status.

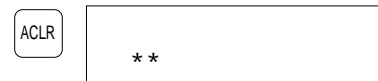

Continuously Monitoring Other System Register Values

Press the ▼ key to increase the register number.

Press the ▲ key to decrease the register number.

Every time you press the key, the system register number will increase/decrease by one.

Pressing the **CLR** key twice, you can clear the LCD.

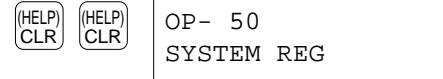

Then repeat from the step 3 to monitor another system registers.

Changing the System Register Value

Caution:

- Before the operation, make sure that the operation result does not affect the program execution nor any other devices. The program will be executed under the conditions set in system registers.

Procedure

On the procedure, it is assumed that you change the value of system register number 5 to 110 in decimal representation.

1. By following the procedure described in “Monitoring System Register Values” section, display the register value you want to change.



2. Press the **CLR** key to clear the value.



3. Select in which representation you enter the value.

Press **K/H** key once to enter the value in decimal. “K” is displayed on the lower line of the LCD.

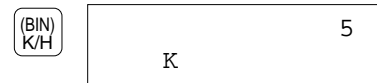

Press **K/H** key again to enter the value in hexadecimal. “H” is displayed on the lower line of the LCD.

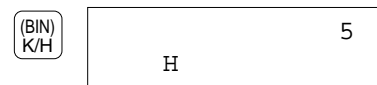

4. Enter the value in the representation you have selected in step 7.

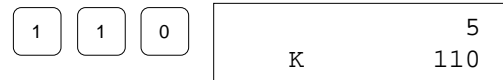

When you have selected the decimal representation, press **1**, **1** and **0** keys in that order to enter “110”.

When you have selected the hexadecimal representation, press **6** and **E** keys in that order to enter “6E”.

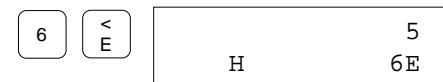

5. Press the **WRT** key to write the value you entered to the programmable controller. Monitoring the system register values will start again.



5.15 Initializing System Registers Settings

OP-51

The OP-51 performs initialization of system registers; sets the default values. The I/O Map, and the Remote I/O Map if you are configuring the Remote I/O System, are also initialized with the OP-51.

Note:

- For details of default values of system registers, refer to the Hardware Manual of your programmable controller.

Procedure

1. Clear the LCD by pressing the **ACLR** key.
The FP Programmer II will become its initial status.



2. Press the **OP**, **5**, **1** and **ENT** keys in that order to operate the OP-51.

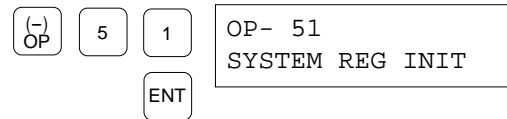

3. Press the **WRT** key.
System registers values will be initialized.
When the system registers are successfully initialized, the LCD will return to its initial status.

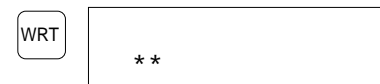

5.16 Allocating I/O Numbers

OP-52

You can register I/O Map on the programmable controller (RAM) with the OP-52. This function is valid for FP3, FP5, FP10S, FP10 and FP-C. The FP1 and FP-M does not have the I/O Map. The FP Programmer II will read how the I/Os are actually allocated, then register it as the I/O Map on the programmable controller.

When you are configuring the Remote I/O System with Master and Slave Units, the FP Programmer II will also read how the I/Os are actually allocated on the Slave Stations, then register it as the Remote I/O Map on the programmable controller.

Notes:

- For details of I/O Map and Remote I/O Map, refer to the Hardware Manual of your programmable controller. For details of Remote I/O Map, also refer to your Remote I/O System Manual.
- With the OP-52, the I/O numbers are allocated based on the actual installation of Units. So, if you want to allocate them arbitrary, use the NPST-GR software.

Procedure

1. Clear the LCD by pressing the **ACLR** key.
The FP Programmer II will become its initial status.

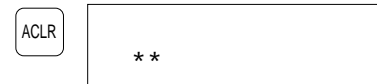

2. Press the **OP**, **5**, **2** and **ENT** keys in that order to operate the OP-52.

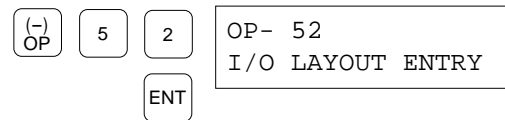

3. Press the **WRT** key.
The I/O Map will be registered on the programmable controller.
If your system includes the Remote I/O System, the Remote I/O Map will be also registered on the programmable controller.
When they are registered successfully, the LCD will return to its initial status.

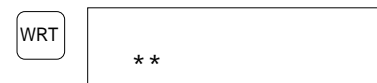

5.17 Selecting the Display Language

OP-70

You can display messages displayed on the LCD in English, German, Italian, French, Spanish or Japanese. With the OP-70, you can select the one from these languages.

As the default settings, English has been selected. The setting you did is valid during the FP Programmer II is ON. Once it is turned OFF, the setting will return to the default setting.

Procedure

1. Clear the LCD by pressing the **ACLR** key.
The FP Programmer II will become its initial status.
2. Press the **OP**, **7**, **0** and **ENT** keys in that order to operate the OP-70.
3. Press the **READ** key.
The language currently selected will be displayed on the LCD.
The number enclosed with the parentheses indicates the key to be pressed to select the language.
4. Select the language in which you want to display messages.
Refer to the table below to select the language you want.
For example, press the **4** key to select French.

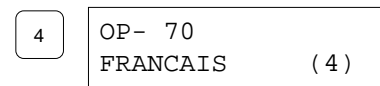
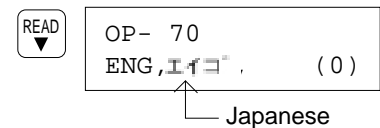
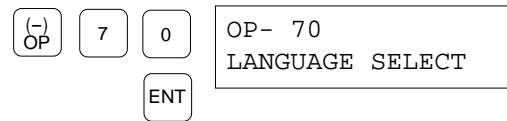
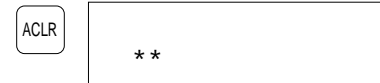

Press	To select	LCD display
0	English	ENG, エイゴ (0)
1	Japanese.	JPN, ニホンゴ (1)
2	Germany.	DEUTSCH (2)
3	Italian.	ITALIANO (3)
4	French	FRANCAIS (4)
5	Spanish	ESPANOL (5)

5. Press the **WRT** key to display messages with the language you selected.
6. Press the **ACLR** key to end the OP-70 operation.

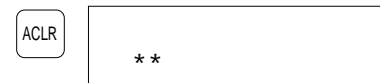

From now, messages will be displayed in the language you selected.

5.18 Adjusting the LCD Contrast

OP-71

The OP-71 adjusts the LCD contrast. The FP Programmer II provides two different contrast (brighter one and darker one).

Procedure

1. Clear the LCD by pressing the **ACLR** key.
The FP Programmer II will become its initial status.



2. Press the **OP**, **7**, **1** and **ENT** keys in that order to operate the OP-71.

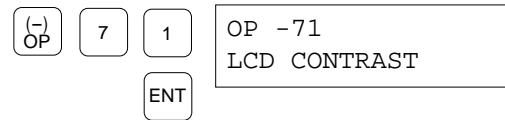

3. Press the **WRT** key. This key toggles the contrast.
When the contrast had been set to the brighter one, it will change to the darker one.
When the contrast had been set to the darker one, it will change to the brighter one.



You can check the contrast on the LCD during the operation.
So, adjust the contrast by pressing the **WRT** key.

4. After the setting, press the **ACLR** key to end the OP-71 operation.

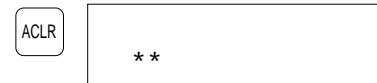

5.19 Entering the Registration Open/Closed State for the Password

OP-72

Caution:

- This function is valid when you have registered a password using the OP-73, while you can operate the OP-72.

With the OP-72, you can set the programmable controller to the Registration Open State and to the Registration Close State. When you registered a password for the programmable controller, you must set the programmable controller to the Registration Open State to edit the program or system registers, then when you finish editing them, set the programmable controller to the Registration Close State to protect them from being edit by other persons.

Procedure

1. Clear the LCD by pressing the **ACLR** key.
The FP Programmer II will become its initial status.

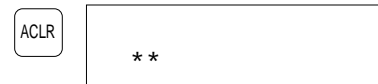

2. Press the **OP**, **7**, **2** and **ENT** keys in that order to operate the OP-72.

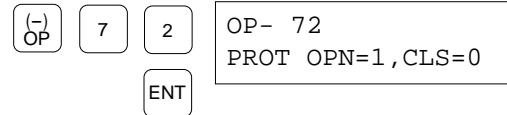

Note:

- “PROT” on the LCD is abbreviation of PROTECT, “OPN” is of OPEN, and “CLS” is of CLOSE.

3. Press the **1** key to set the programmable controller to the Registration Open State. Then, the FP Programmer II prompt to enter the password you set with the OP-73. Go to the step 4.

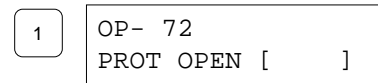

Press the **0** key to set the programmable controller to the Registration Close State. Go to the step 5.

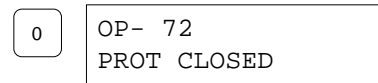

4. Enter the password you registered with the OP-73 operation.

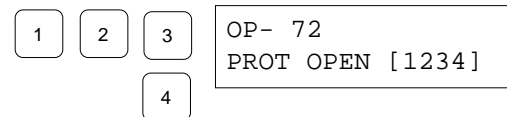

5. Press the **WRT** key. The programmable controller will go to the state you specified on the step 3. The FP Programmer II will return to its initial status.

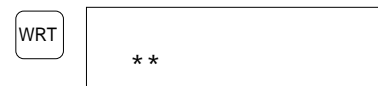

If you have entered a wrong password on the step 4, the FP Programmer II will display the error message, “PARAMETER ERR!60” on the LCD. Press the **CLR** key to clear the LCD, then repeat from step 4 with the correct password.

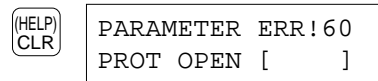

5.20 Registering and Cancel the Password OP-73

Caution:

- When the programmable controller is under the ROM operation, the OP-73 operation is invalid.

With the OP-73 operation, you can register a password to the programmable controller, and cancel the password registered on the programmable controller.

You can register a password in hexadecimal with a maximum of 4 digits.

After the registration, you must set the programmable controller to the registration close state to protect program from being read or edited. When you want to edit the program, you must set the programmable controller to the registration open state. These settings can be done with the OP-72. Refer to “5.19 Specifying the Registration Open/Close State for the Password” for operation details.

When you get the password unnecessary, you can cancel the password any time with the OP-73. If you have forgotten the password, you can cancel the password forcibly with the OP-74. However, if you operate the OP-74, the program will be cleared and also system register settings will be initialized.

Registering a Password

Procedure

1. Clear the LCD by pressing the **ACLR** key.
The FP Programmer II will become its initial status.

ACLR	**
------	----
2. Press the **OP**, **7**, **3** and **ENT** keys in that order to operate the OP-73.

(-) OP	7	3	OP- 73 PASSWORD
		ENT	
3. Press the **0** key to register a password. The message shown on the right will be displayed on the LCD.

0	PASSWORD SETTING []
---	----------------------------
4. Enter a password in hexadecimal.
You can enter a maximum of 4 digits for the password.
For example, press **1**, **2**, **3** and **4** keys to enter the password, “1234”.
Please note the password you set so that you will not forget it.

1	2	3	PASSWORD SETTING [1234]
		4	
5. Press the **WRT** key.
The confirmation message will appear on the LCD.

WRT	YES=0 , NO=1 [1234]
-----	--------------------------

Note:

- If you press the **ENT** key again after the step 2, you can display the options as shown on the right, then you can know the key to be pressed.

ENT	PASSWORD SET=0 , CANCELL=1
-----	-------------------------------

6. When the password you set is OK, press the **0** key.
The password will be registered to the programmable controller,
then the FP Programmer II will return to its original status.

0 * *

If no, press the **1** key. The FP Programmer II will be return
to the status at the step 3. Repeat from the step 3, or if you
want to quit the operation, press the **ACLR** key.

1 PASSWORD SETTING
[0000]

Note:

- Never forget the password you registered. When you make the programmable controller to the registration open/close state, or you cancel the password, you must enter the password you registered. If you forgot the password, you can cancel the password using the OP-74. However, if you operate OP-74, the program and system register settings are all erased.

Cancelling the Password

To cancel the password set on the programmable controller, first you must set the programmable controller to the registration open state. Refer to “5.19 Specifying the Registration Open/Close State for the Password” for operation details.

Procedure

- Clear the LCD by pressing the **ACLR** key.
The FP Programmer II will become its initial status.
- Press the **OP**, **7**, **3** and **ENT** keys in that order to operate the OP-73.
- Press the **1** key to register a password. The following message will be displayed on the LCD.
- Press the **WRT** key to cancel the password.
When the password is successfully cancelled, the FP Programmer II will return to its initial status.

ACLR * *

(-) OP 7 3 OP- 73
PASSWORD
ENT

1 PASSWORD CANCEL

WRT * *

If the programmable controller has not been in the registration open state, the error message “PROTECT ERR !65” will be displayed on the LCD.

PROTECT ERR !65

Press the **ACLR** key, then operate the OP-72 to make the programmable controller registration open state.

Note:

- If you press the **ENT** key again after the step 2, you can display the options as shown on the right, then you can know the key to be pressed.

ENT PASSWORD
SET=0 , CANCEL=1

5.21 Cancelling the Password (Forced Cancel)

OP-74

If you forget the password set for a programmable controller, you can cancel the password using OP-74. However if you operate the OP-74, the program stored in the programmable controller will be erased and system register values stored in the programmable controller will be initialized.

Before the operation, make sure that the programmable controller is in the PROG. Mode.

Procedure

1. Clear the LCD by pressing the **ACLR** key.
The FP Programmer II will become its initial status.

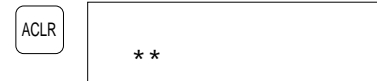

2. Press the **OP**, **7**, **4** and **ENT** keys in that order to operate the OP-74.

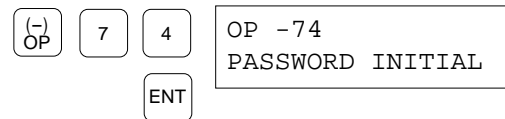

3. Press the **0** key to cancel the password forcedly.
When the password is successfully cleared, the screen will return to its initial status.

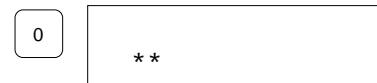

If you quit the operation, press the **1** key. The FP Programmer II will return to the previous status shown on the step 2.

If the password had not been registered, or the programmable controller is in the RUN Mode, the error message, "PLC MODE ERR !63" will be displayed on the LCD.

PLC MODE ERR !63

If the programmable controller is under the ROM operation, the error message, "PROTECT ERR !65" will be displayed on the LCD

PROTECT ERR !65

Notes:

- To cancel the password forcedly, the FP Programmer II will verify the password you set with password starting from "0000". So, if you have set the password to "FFFF", it will take about 80 minutes with 9600 bps.
- If you press the **ENT** key again after the step 2, you can display the options as shown on the right, then you can know the key to be pressed.

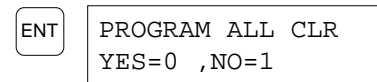

5.22 Transferring a Program to RAM from ROM

OP-90

The program stored in the Memory Unit/Master Memory Unit (in case of the FP1), ROM (in case of the FP3, FP5, FP-M and FP-C), or IC Memory Card (in case of the FP10S and FP10) can be transferred to the RAM in the programmable controller using OP-90.

Note:

- If you use the FP1, the program will be automatically transferred to the RAM from the Master Unit/Master Memory Unit when you make the mode of programmable controller to RUN Mode after installing the Master Unit/Master Memory Unit.

Procedure

1. Clear the LCD by pressing the **ACLR** key.
The FP Programmer II will become its initial status.

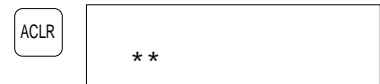

2. Press the **OP, 9, 0** and **ENT** keys in that order to operate the OP-90.

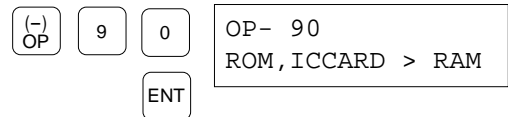

3. Press the **WRT** key to start transferring data from ROM or IC Memory Card to RAM.
When the transfer has been completed successfully, the FP Programmer II will return to its initial status.

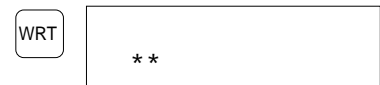

5.23 Transferring a Program between the Programmable Controller and the FP Programmer II OP-91

With the OP-91, you can transfer a program from the FP Programmer II to the programmable controller, or from the programmable controller to the FP Programmer II.

You can also verify the two programs and system register values stored in the FP Programmer II and in the programmable controller.

Together with the program, system register values are also transferred or verified.

You can transfer a maximum of 12 kilo steps together with the system register data (512 steps) and a program. To back up the data stored in the FP Programmer II, the bulk condenser is applied. So, it can maintain the data about three days with one-hour charge, and about 30 minutes with one-minute charge, while the period will vary depending the ambient conditions or the period how long the programmer has been used.

Note:

- When you transfer them which was uploaded from a programmable controller to the FP Programmer II, to the another programmable controller, you can transfer them to the only the same type of programmable controller.

Procedure

1. Clear the LCD by pressing the **ACLR** key.
The FP Programmer II will become its initial status.

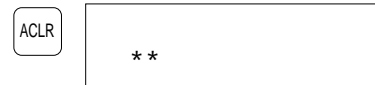

2. Press the **OP**, **9**, **1** and **ENT** keys in that order to operate the OP-91.

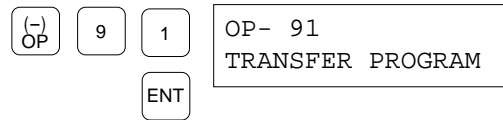

3. Press the **0** key to transfer the program from a programmable controller to the FP Programmer II.

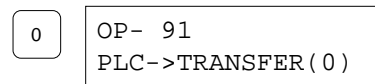

Press the **1** key to transfer a program from the FP Programmer II to a programmable controller.

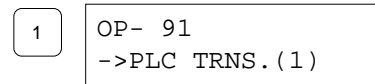

Press the **2** key to verify the two programs stored in the FP Programmer II and in a programmable controller.

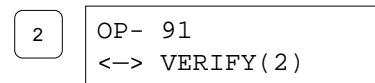

4. Press the **WRT** key to start processing. While processing, the asterisk(*) at the lower right of the LCD will keep flashing.

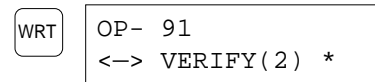

After completing the processing, the FP Programmer II will return to its initial status.



Note:

- If you press the **ENT** key again after the step 2, you can display the option as shown on the right.

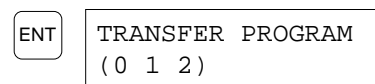

5.24 Transferring System Register Values between the Programmable Controller and the FP Programmer II OP-92

With the OP-92, you can transfer only the system register values from the FP Programmer II to the programmable controller and from the programmable controller to the FP Programmer II. You can also verify the system register settings stored in the FP Programmer II and in the programmable controller.

To back up the data stored in the FP Programmer II, the bulk condenser is applied. So, it can maintain the data about three days with one-hour charge, and about 30 minutes with one-minute charge, while the period will vary depending the ambient conditions or the period how long the programmer has been used.

Note:

- When you transfer them which was uploaded from a programmable controller to the FP Programmer II, to the another programmable controller, you can transfer them to the only the same type of programmable controller.

Procedure

1. Clear the LCD by pressing the **ACLR** key.
The FP Programmer II will become its initial status.

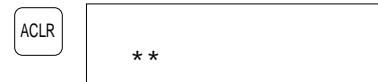

2. Press the **OP**, **9**, **2** and **ENT** keys in that order to operate the OP-92.

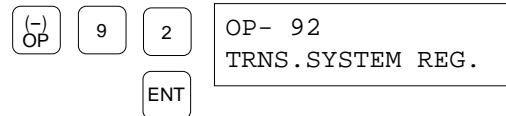

3. Press the **0** key to transfer the system register values from a programmable controller to the FP Programmer II.

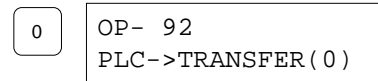

Press the **1** key to transfer system register values from the FP Programmer II to a programmable controller.

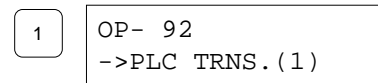

Press the **2** key to verify the system register values stored in the FP Programmer II and in a programmable controller.

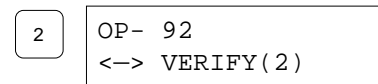

4. Press the **WRT** key to start processing. While processing, the asterisk(*) at the lower right of the LCD will keep flashing.

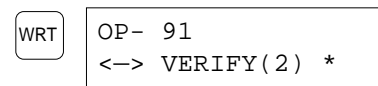

After completing the processing the FP Programmer II will return to its initial status.



Note:

- If you press the **ENT** key again after the step 2, you can display the options as shown on the right.

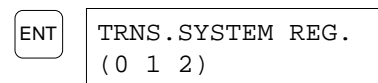

5.25 Transferring a Program to ROM from Internal RAM OP-99

The program stored in the internal RAM can be transferred to the Memory Unit/Master Memory Unit (in case of the FP1), ROM (in case of the FP3, FP5, FP-M and FP-C), or IC Memory Card (in case of the FP10S and FP10) using OP-99.

Note:

- If you use the FP1, the program will be automatically transferred to the RAM from the Master Unit/Master Memory Unit when you make the mode of programmable controller to RUN Mode after installing the Master Unit/Master Memory Unit. So, before the operation, make sure the programmable controller is in the PROG. Mode.

Procedure

1. Clear the LCD by pressing the **ACLR** key.
The FP Programmer II will become its initial status.

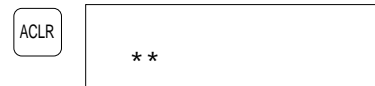

2. Press the **OP**, **9**, **9** and **ENT** keys in that order to operate the OP-99.

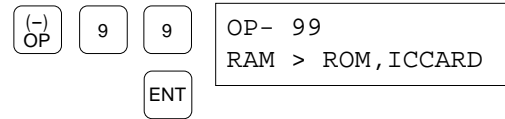

3. Press the **WRT** key to start transferring data.
When the program is successfully transferred from the internal RAM to the Master Unit/ROM/IC Memory Card, the FP Programmer II will return to its initial status.

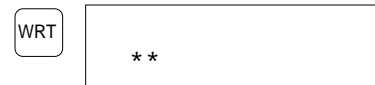

5.26 Display the Self-diagnostic Error Codes on the FP Programmer II

OP-110

On the FP Programmer II, you can display the self-diagnostic error codes detected on the programmable controller. Follow the procedure described below.

Procedure

1. Clear the LCD by pressing the **ACLR** key.
The FP Programmer II will become its initial status.



2. Press the **OP**, **1**, **1**, **0** and **ENT** keys in that order to operate the OP-110.

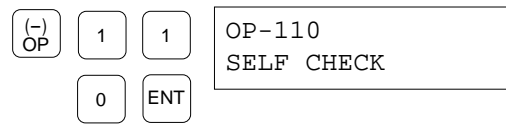

3. Press the **READ** key to display the error message.

If no error has been detected on the programmable controller, the FP Programmer II will return to its initial status.

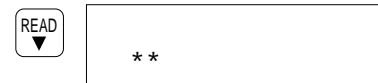

If any error has been detected on the programmable controller, the FP Programmer II will display the corresponding error code. On the figure right, the battery error whose error code is E50 has been detected.

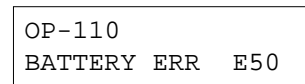

If any function error has been detected, you can display the first address where the error was detected by pressing the **READ** key.

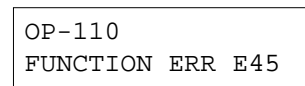

At "XXXXX" position the first address where an error was detected will be displayed.

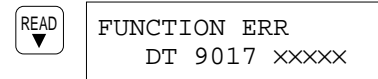

In case of the FP10 and FP10S, the error address will be stored at DT90017.

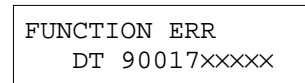

Caution

- If your programmable controller is the FP1, you can not display the error address.

5.27 Clearing Message Displayed on the FP Programmer II OP-111

When the MSG instruction (F149/P149) is executed on the programmable controller, the FP Programmer II will display message from the programmable controller. You can clear the message by following the procedure below.

Procedure

1. Clear the LCD by pressing the **ACLR** key.
The FP Programmer II will become its initial status.



2. Press the **OP**, **1**, **1**, **1** and **ENT** keys in that order to operate the OP-111.



3. Press the **SHIFT** key.
An under bar will be displayed on the next to the word "OP".

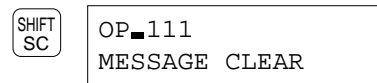

4. Press the **(DEL)** key to clear the message.
When successfully the message was cleared, the FP Programmer II will return to its initial status.

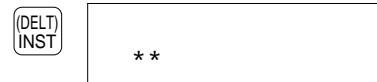

5.28 Turning OFF the ERROR LED on the CPU

OP-112

You can turn OFF the ERROR LED on the CPU from the FP Programmer II to clear the error status on the programmable controller.

Before operating the OP-112, first discriminate the cause of error. Otherwise, immediately after operating the OP-112, the LED will turn ON again.

Procedure

1. Clear the LCD by pressing the **ACLR** key.
The FP Programmer II will become its initial status.

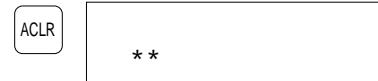

2. Press the **OP**, **1**, **1**, **2** and **ENT** keys in that order to operate the OP-112.

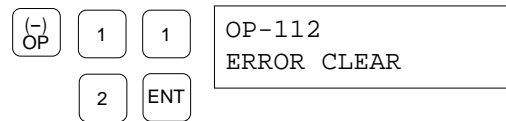

3. Press the **SHIFT** key.
An under bar will be displayed on the next to the word "OP".

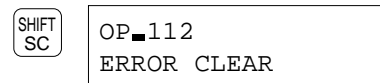

4. Press the **(DEL)** key to clear the message.
When successfully the ERROR LED was turned OFF, the FP Programmer II will return to its initial status.

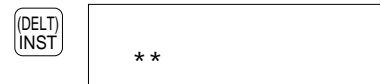

CHAPTER 6

CARRYING A PROGRAM

6.1 Carrying a Program	96
------------------------------	----

6.1 Carrying a Program

You can temporarily store a program in the FP Programmer II transferred from a programmable controller or the NPST-GR, FP series programming software and transfer it to them. While you cannot edit the program uploaded from a programmable controller or the NPST-GR, this function may be useful to carry a program between the programmable controller and the NPST-GR.

Even if the NPST-GR is activated on a remote computer, you can transfer a program to or from the NPST-GR via the modems. The NPST-GR which communicates with the FP Programmer II via the modem is called “remote NPST-GR” in this chapter.

On the FP Programmer II, you can store up to 12 k steps of program including 512 steps of system register parameters. The program stored on the FP Programmer II is maintained by the large capacity condenser (0.22F) built-in the programmer, which can be charged by connecting the programmer to the programmable controller. Charging one hour will maintain the program for about 72 hours after disconnected the FP Programmer II from the programmable controller. If you charging one minute, it will be maintained for about 30 minutes.

Note:

- Any version of the NPST-GR is available to upload or download the program from or to the NPST-GR.
- To connect the FP Programmer II with the programmable controller for charging the condenser, refer to “1.3 Setting-up the FP Programmer II”.
- The period the program will be maintained in the FP Programmer II may be shorter depending on the operation environment.
- You can neither display nor edit the program transferred from a programmable controller or the NPST-GR.

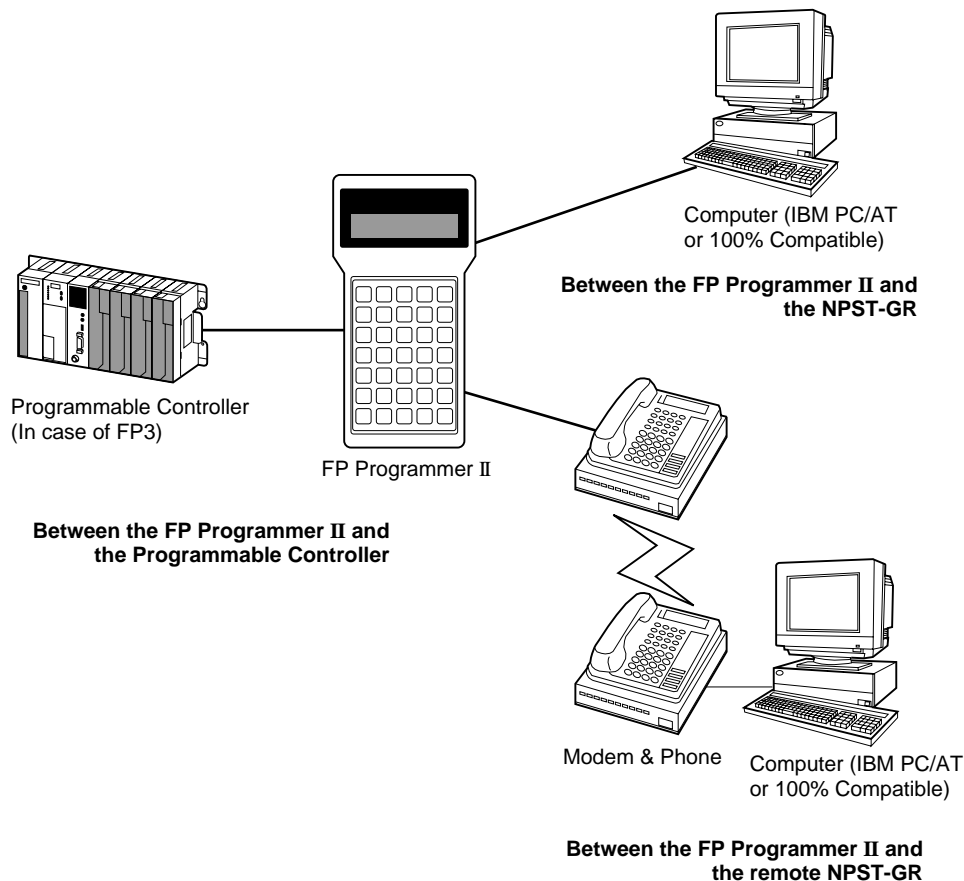

Transferring a Program between the FP Programmer II and the Programmable Controller

To transfer the program between the FP Programmer II and the programmable controller, connect the FP Programmer II with the programmable controller, then operate the OP-91 or OP-92.

Operate the OP-91 to transfer both of the program and system register parameters.

Operate the OP-92 to transfer only system register parameters.

To connect the FP Programmer II with the programmable controller, refer to “1.5 Setting-up the FP Programmer II”. Make sure the connection cable is the right one.

To operate the OP-91, refer to “5.23 Transferring a Program between the programmable controller and the FP Programmer II”.

To operate the OP-92, refer to “5.24 Transferring System Register Parameters between the programmable controller and the FP Programmer II”.

Transferring the Program between the FP Programmer II and the NPST-GR

The procedures given in this section assume that the NPST-GR has already started on the computer and that the computer is the IBM PC/AT or the 100% compatible. For the operation details for the NPST-GR, refer to the NPST-GR manual.

Note:

- All the functions of the NPST-GR, except the functions, [LOAD PROGRAM TO PLC] and the [LOAD PROGRAM FROM PLC] ([LOAD PROGRAM → PC] and [LOAD PROGRAM ← PC] in earlier version than Ver.3.0), will be invalid while the FP Programmer II is connected to the NPST-GR.

Preparing Cables

To connect the FP Programmer II with the computer, you need:

- A FP Programmer II computer cable (Part No. AFP1551)
- An electric source with the voltage DC5V±5% and 1 W or more.
- A conversion cable.

Use the one commercially available or make the one by yourself. For more information about the pin assignments of the conversion cable, refer to “Appendix E Conversion Cable”.

Connecting the FP Programmer II with the NPST-GR

1. If the NPST-GR is in the ONLINE mode, change it to the OFFLINE mode by pressing the **ESC** key while holding down the **Ctrl** key.
2. On the NPST-GR, set the communication parameters as shown below.
You can set them using the [NPST CONFIGURATION] function of the NPST-GR.

Baud rate:	9,600 bps
Data bit:	8 bits
Parity check:	Odd
Stop bit:	1 bit

If your NPST-GR software is the version 3.1, refer to the “Chapter 12 Configuring the NPST-GR” of the NPST-GR manual for the setting.

If the version is earlier than 3.0, refer to the “7.7 NPST-GR Configuration” for the setting.

6.1 Carrying a Program

3. Connect the FP Programmer II with the computer, using the FP Programmer II computer cable and the conversion cable as shown below.

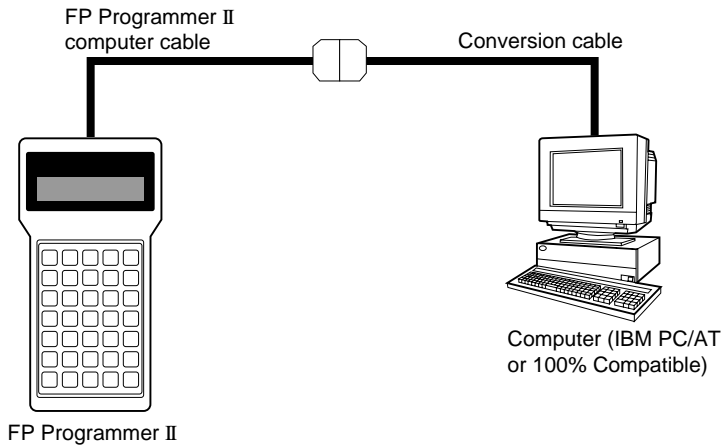

Connect the female 15-pin connector of the FP Programmer II computer cable with the FP Programmer II connector. Connect the male 25-pin connector of the FP Programmer II computer cable with the female 25-pin connector of the conversion cable. Connect the 9-pin female connector of the conversion cable with the 9-pin male connector of the computer.

4. Connect the power source with the power lines of the FP Programmer II computer cable, red(+) line and black(-) line, to supply the power to the FP Programmer II. Connect the terminal of the red line to the + terminal on the power source. Connect the terminal of the black line to the - terminal on the power source.

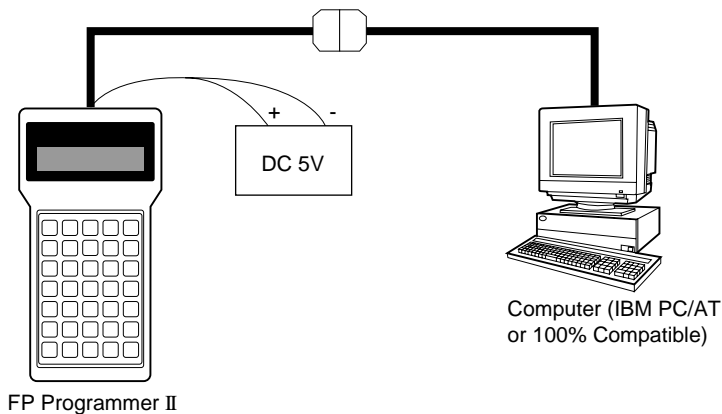

5. Make sure that the message, "PLC TYPE SELECT" is displayed on the LCD of the FP Programmer II.

PLC TYPE SELECT YES=0, NO=1

Downloading the Program from the FP Programmer II to the NPST-GR

The program stored in the FP Programmer II can be transferred to the NPST-GR. Follow the procedure described below.

Procedure

1. Make sure that the message, “PLC TYPE SELECT” is displayed on the LCD of the FP Programmer II.

```
PLC TYPE SELECT
YES=0, NO=1
```

2. Press the **1** key on the FP Programmer II not to select the PLC type.
The message “WAITING” will appear. This shows that the FP Programmer II is waiting for the program transfer.

1

```
WAITING
```

3. On the NPST-GR, change it to the ONLINE mode by pressing the **ESC** key while holding down the **Ctrl** key.
4. When your NPST-GR is version 3.1 or later, operate the **[LOAD PROGRAM FROM PLC]** function. Refer to “14.4 Uploading the Program from the Programmable Controller” in the NPST-GR manual.
When your NPST-GR version is earlier than 3.1, operate the **[LOAD PROGRAM ← PC]** function. Refer to “6.1 Loading the Program from PC” in the NPST-GR manual.

While the program is being downloaded to the NPST-GR, the message “COMMUNICATING” will be displayed and an asterisk(*) will blink on the LCD of the FP Programmer II.

```
COMMUNICATING *
```

When the program is downloaded successfully, you will get the message “WAITING” on the LCD of the FP Programmer II again.

```
WAITING
```

Uploading the Program from the NPST-GR to the FP Programmer II

The FP Programmer II can temporarily store a program transferred from the NPST-GR. Follow the procedure described below.

Caution:

- If any program has been stored to the FP Programmer II and you upload another program from the NPST-GR, the existing program will be replaced with the program uploaded this time.

Procedure

1. Make sure that the message, “PLC TYPE SELECT” is displayed on the LCD of the FP Programmer II.

```
PLC TYPE SELECT
YES=0, NO=1
```

2. Press the **0** key on the FP Programmer II to select the type of programmable controller.
The type of programmable controller will be shown on the LCD.

0

```
PLC TYPE SELECT
FP1-C14,C16 [04]
```

3. Display the type of programmable controller with which the FP Programmer II is connected, by pressing the ▲ or ▼ key.
4. Press the **WRT** key to register the type of programmable controller you selected.
The message “WAITING” will appear. This shows that the FP Programmer II is waiting for program transfer.
5. On the NPST-GR, change it to the ONLINE mode by pressing the **ESC** key while holding down the **Ctrl** key.
6. When your NPST-GR is version 3.1 or later, operate the **[LOAD PROGRAM TO PLC]** function. Refer to “14.5 Downloading the Program to the Programmable Controller” in the NPST-GR manual.
When your NPST-GR version is earlier than version 3.1, operate the **[LOAD PROGRAM → PC]** function. Refer to “6.2 Saving the Program to PC” in the NPST-GR manual.



While the program is being downloaded to the NPST-GR, the message “COMMUNICATING” will be displayed and an asterisk(*) will blink on the LCD of the FP Programmer II.



When the program is downloaded successfully, you will get the message “WAITING” on the LCD of the FP Programmer II again.



Transferring the Program between the FP Programmer II and the Remote NPST-GR

The procedures given in this section assume that the NPST-GR has already started on the computer (IBM PC/AT or the 100% compatible), and the computer is connected with a HAYES modem. For the connection and operation details for the NPST-GR, refer to the NPST-GR manual.

Note:

- All the functions of the NPST-GR, except the functions **[LOAD PROGRAM TO PLC]** and the **[LOAD PROGRAM FROM PLC]** (**[LOAD PROGRAM → PC]** and **[LOAD PROGRAM ← PC]** in earlier version than Ver.3.1) will be invalid while the FP Programmer II is connected to the NPST-GR.

Preparing Modem and Cables

Modem

- Use the modem which supports the Hayes AT commands.

Cables

To connect the FP Programmer II with the remote computer, you need:

- the FP Programmer II computer cable
- the electric source with the voltage $DC5V \pm 5\%$ and 1 W or more.
- the cross cable or the adapter for connecting the modem. You can use the one commercially available or make the cable by yourself. For more information about the wiring, refer to “Appendix F Cross Cable”.

Connecting the FP Programmer II to the Remote NPST-GR

1. If the NPST-GR is in the ONLINE mode, change it to the OFFLINE mode by holding down the **Ctrl** key and press the **ESC** key.
2. On the NPST-GR, set the communication parameters as shown below.
You can set them using the **[NPST CONFIGURATION]** function of the NPST-GR.

Baud rate: 2,400 bps
 Data bit: 8 bits
 Parity check: None
 Stop bit: 1 bit

If your NPST-GR is the version 3.1 or later, refer to the “Chapter 12 Configuring the NPST-GR” of the NPST-GR manual.

If the version is earlier than 3.1, refer to the “7.7 NPST-GR Configuration.”

3. Connect the FP Programmer II with the computer via modems, as referring to the figure below.

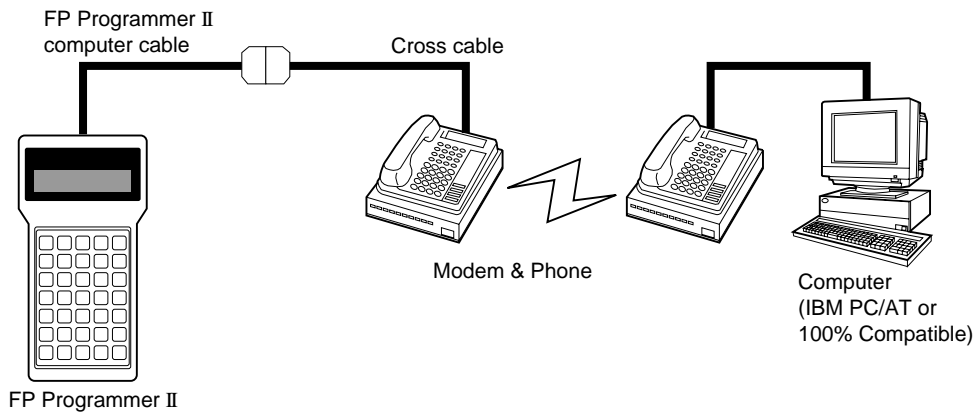

Connect the female 15-pin connector of the FP Programmer II computer cable with the FP Programmer II connector.
 Connect the male 25-pin connector of the FP Programmer II computer cable with the female 25-pin connector of the cross cable.

Connect the 25-pin male connector of the cross cable with the 25-pin female connector of the modem.

- Connect the power source with the power lines of the FP Programmer II computer cable, red(+) line and black(-) line, to supply the power to the FP Programmer II.
Connect the terminal of the red line to the + terminal on the power source.
Connect the terminal of the black line to the - terminal on the power source.

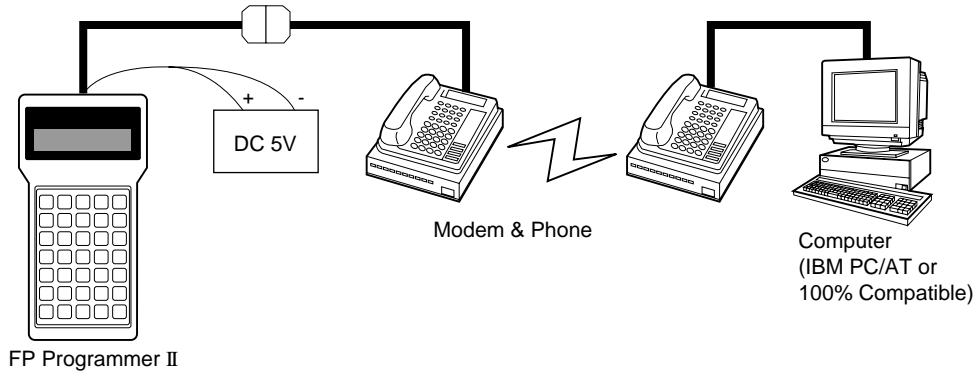

- Make sure that the message, “PLC TYPE SELECT” is displayed on the LCD of the FP Programmer II.

PLC TYPE SELECT
YES=0, NO=1

Downloading the Program from the FP Programmer II to the remote NPST-GR

The program stored in the FP Programmer II can be transferred to the remote NPST-GR via modems. Follow the procedure described below.

Procedure

- Make sure that the message, “PLC TYPE SELECT” is displayed on the LCD of the FP Programmer II.
- Press the **1** key on the FP Programmer II not to select the type of programmable controller.
The message “WAITING” will appear. This shows that the FP Programmer II is waiting for program transfer.
- Enter the Modem mode by pressing the **OP, 9, 3** and **ENT** keys in that order.
The FP Programmer II will set its communication parameters so that it can receive data from the modem, and initialize the modem.
- On the NPST-GR, connect the telephone line between the NPST-GR and the FP Programmer II.
You can connect it using the [NPST CONFIGURATION] function of the NPST-GR.
If your NPST-GR is the version 3.1, refer to the “Chapter 12 Configuring the NPST-GR” of the NPST-GR manual.
If the version is earlier than 3.1, refer to the “7.7 NPST-GR Configuration.”

PLC TYPE SELECT
YES=0, NO=1

1

WAITING

(-)
OP

9

3

ENT

OP- 93 ****

After the telephone line is connected, the message “MODEM WAITING” will appear on the LCD of the FP Programmer II.

MODEM WAITING

5. On the NPST-GR, change it to the ONLINE mode by pressing the **ESC** key while holding down the **Ctrl** key.
6. When the NPST-GR is version 3.1 or later, operate the **[LOAD PROGRAM FROM PLC]** function. Refer to “14.4 Uploading the Program from the Programmable Controller” in the NPST-GR manual for the operation details. When the NPST-GR version is earlier than 3.1, operate the **[LOAD PROGRAM ← PLC]** function. Refer to “6.1 Loading Program from PC” in the NPST-GR manual.

While the program is being downloaded to the NPST-GR, the message “COMMUNICATING” will be displayed and an asterisk(*) will blink on the LCD of the FP Programmer II.

COMMUNICATING *

When the program is downloaded successfully, you will get the message “WAITING” on the LCD of the FP Programmer II again.

MODEM WAITING

Uploading the Program from the FP Programmer II to the Remote NPST-GR

The FP Programmer II can temporarily store a program transferred from the Remote NPST-GR. Follow the procedure described below.

Caution:

- If any program has been stored to the FP Programmer II and you upload another program from the NPST-GR, the existing program will be replaced with the uploaded one.

Procedure

1. Make sure that the message, “PLC TYPE SELECT” is displayed on the LCD of the FP Programmer II.
2. Press the **0** key on the FP Programmer II to select the type of programmable controller.
The type of programmable controller will be shown on the LCD.
3. Display the type of programmable controller with which the FP Programmer II is connected, by pressing the **▲** or **▼** key.
4. Press the **WRT** key to register the type of programmable controller you selected.
The message “WAITING” will appear. This shows that the FP Programmer II is waiting for program transfer.

PLC TYPE SELECT
YES=0, NO=1

0

PLC TYPE SELECT
FP1-C14,C16 [04]

WRT

WAITING

6.1 Carrying a Program

5. Enter the Modem mode by pressing the **OP**, **9**, **3** and **ENT** keys in that order.
The FP Programmer II will set its communication parameters so that it can receive data from the modem, and initialize the modem.

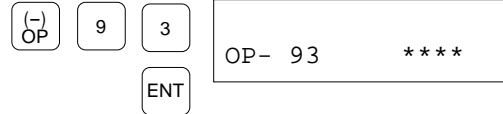

6. On the NPST-GR, connect the telephone line between the NPST-GR and the FP Programmer II.
You can connect it using the **[NPST CONFIGURATION]** function of the NPST-GR.
If your NPST-GR is the version 3.1, refer to the “Chapter 12 Configuring the NPST-GR” of the NPST-GR manual.
If the version is earlier than 3.1, refer to the “7.7 NPST-GR Configuration.”

After the telephone line is connected, the message “MODEM WAITING” will appear on the LCD of the FP Programmer II.

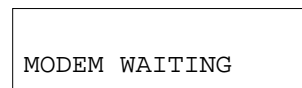

7. On the NPST-GR, change it to the ONLINE mode by pressing the **ESC** key while holding down the **Ctrl** key.
8. When the NPST-GR is version 3.0 or later, operate the **[LOAD PROGRAM FROM PLC]** function. Refer to “??” in the NPST-GR manual for the operation details.
When the NPST-GR version is earlier than 3.0, operate the **[LOAD PROGRAM ← PLC]** function. Refer to “6.1 Loading Program from PC” in the NPST-GR manual.

While the program is being downloaded to the NPST-GR, the message “COMMUNICATING” will be displayed and an asterisk(*) will blink on the LCD of the FP Programmer II.

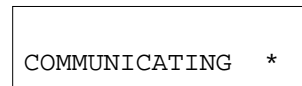

When the program is downloaded successfully, you will get the message “WAITING” on the LCD of the FP Programmer II again.

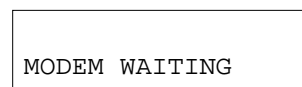

APPENDIXES

Appendix A	Error Messages	106
Appendix B	List of Instructions	123
Appendix C	Key Operations	138
Appendix D	General Specifications	160
Appendix E	Conversion Cable.....	161
Appendix F	Cross Cable	162
Appendix G	FP Programmer II Coding Sheet.....	163
Appendix H	FP Programmer I/O List	164
Appendix I	Differences between the FP Programmer Series	165
Index		167

Appendix A Error Messages

When an error message is displayed on the LCD, refer to the tables shown below to get correct action for the message. The tables are classified with when error message appear.

On the “A-2 Self-diagnostic Error Codes”, the error codes, displayed when you operate the OP-110, self-diagnostic check, will be listed.

Note:

- Note that the self-diagnostic codes E100 to E299 are the codes which are set with the F148(ERR) or P148(PERR)(self-diagnostic error set instruction). They are not listed in the “A-2 Self-diagnostic Error Codes.” If the error occurs, the corresponding code will be displayed like “E100” on the LCD. For more information about the F148 and P148, refer to the Programming Manual for your programmable controller.

Beep Sound

When you press a key, the FP Programmer II always beeps once. This is not an error. But beeping twice or beeping continuously indicates that you operated it incorrectly.

Beeping twice tells you that you pressed the wrong key. You can continue the operation by pressing the correct key.

When the FP Programmer II beeps continuously, an error message will be displayed at the upper line of the LCD. Press the **CLR** key to stop beeping, then correct the error. If you do not know how to continue the operation, refer to “A-1 Error Messages” which list the error messages and the action you should take.

A-1 Error Messages

The messages will be displayed in the language you have previously selected with the OP-70. In the tables, the messages are listed in English, German, Italian, French, Spanish and Japanese in that order.

When Entering the Instruction

Error Message		Action
SYNTAX ERR	1	You entered the instruction incorrectly. Referring to the Programming Manual for your programmable controller, enter the correct instruction.
SYNTAXFEHLER	1	
ERR SINTASSI	1	
ERR SYNTAXE	1	
ERR SINTAXIS	1	
ブ`ンボ`ウエラー	1	
SYNTAX ERR	4	The operand you entered is out of the range with you have set in the system registers. Check the system register values by operating the OP-50. Enter the correct operand, or change the system register parameter.
SYNTAXFEHLER	4	
ERR SINTASSI	4	
ERR SYNTAXE	4	
ERR SINTAXIS	4	
ブ`ンボ`ウエラー	4	
SYNTAX ERR	8	You entered a wrong operand. Enter the correct operand for the instruction referring to the Programming Manual for your programmable controller.
SYNTAXFEHLER	8	
ERR SINTASSI	8	
ERR SYNTAXE	8	
ERR SINTAXIS	8	
ブ`ンボ`ウエラー	8	
SYNTAX ERR	9	You entered the instruction which your programmable controller does not support. Use the valid instruction referring to the Programming Manual for your programmable controller.
SYNTAXFEHLER	9	
ERR SINTASSI	9	
ERR SYNTAXE	9	
ERR SINTAXIS	9	
ブ`ンボ`ウエラー	9	

When Reading the Instruction from the Programmable Controller

Note:

- When reading the instruction from the programmable controller, the FP Programmer II will not beep exceptionally even if any error message appears.

Error Message	Action
SYNTAX 1	The instruction you read has the syntax error. Enter the instruction correctly or delete the wrong instruction.
SYNTAX 1	
SINTASSI 1	
SYNTAXE 1	
SINTAXIS 1	
フンボウエラー 1	
SYNTAX 4	Any operand for the instruction you read is out of the range which you have set in the system registers. Check the system register values by operating the OP-50. Enter the correct operand, or delete that instruction. Or, change the system register values.
SYNTAX 4	
SINTASSI 4	
SYNTAXE 4	
SINTAXIS 4	
フンボウエラー 4	
SYNTAX 8	Any operand for the instruction you read is incorrect. Enter the correct instruction referring to the Programming Manual for your programmable controller. Or, delete that instruction.
SYNTAX 8	
SINTASSI 8	
SYNTAXE 8	
SINTAXIS 8	
フンボウエラー 8	

When Operating OP-9 or OP-30 When Operating FP Programmer II in TEST Mode

When you operate the OP-9 to check the program, and any error is found, the address where the error exists and the corresponding error message will be displayed.

When you change the mode of programmable controller from the PROG. mode to the RUN mode with the OP-30, the programmable controller will automatically check the program before executing it. When any error is found at that time, the mode of programmable controller will not be changed and the corresponding error message will appear. The address where the error exists will not be displayed. If you want to know the address, operate the OP-9.

In the TEST mode, it is possible that only the error message "PROGRAM ERR" listed at the end of the following table will be displayed.

Error Message	Action
SYNTAX	Syntax error. Enter the instruction correctly referring to the Programming Manual for your programmable controller, or delete the instruction.
SYNTAX	
SINTASSI	
SYNTAXE	
SINTAXIS	
フンホウ	
DUP USE	Duplicated output error. You are using the two or more same output instructions in the program. Modify the program not to use the same output instruction. Or, you can enable the duplicated output instructions by changing the parameter of the system register No.20 with the OP-50.
DOPP. BELEG.	
DOPIO USO	
DBL. EMPLOI	
USO DOBLE	
ダブリエラ	
PAIR	Not paired error. One of the instructions which must be paired is missing. For example, JP(jump) and LBL(label) instructions must be entered together. Enter the missing instruction. Otherwise, the paired instructions may have been entered in the opposite positions. Enter these instructions at the correct positions referring to the Programming Manual for your programmable controller.
PAAR	
COPPIA	
APPAIRAGE.	
SIN PAREJA	
ペア-	
MISMATCH	System register parameter error. The operand for the instruction is out of range which you have set at the system registers. Check the system register parameter by operating the OP-50. Correct the instruction or change the corresponding system register values.
VERWECHSLUNG	
NON COERENTE	
COHERENCE	
NO COHERENTE	
ミスマッチ	
PROG AREA	An instruction exists where it must not exist. Enter the instruction at the correct position, referring to the Programming Manual for your programmable controller.
PROG. BEREICH	
AREA PROG	
EMPLAC. INST	
AREA DE PROG	
PROG エラ	

Error Message	Action
COMPILE FULL	Not entire program could be compiled. You have to modify the program so that the number of steps for the program is smaller than the program capacity. (This message will appear only when the programmable controller is FP10S or FP10.)
COMPILE FULL	
COMPILE FULL	
COMPILE FULL	
COMPILE FULL	
コンパイル フル	
OPCD COMBI	High level instruction type error. Both scan execution type instructions and pulse execution type instructions exist in the program. Unify the instruction type.
OPCD COMBI	
OPCD COMBI	
OPCD COMBI	
OPCD COMBI	
OPCD 高レベル	
OPR COMBI	Operand error. Incorrect operands have been entered for the instruction. Enter the correct operand, referring to the Programming Manual for your programmable controller.
OPR COMBI	
OPR COMBI	
OPR COMBI	
OPR COMBI	
OPR 演算子	
PROGRAM ERR	The CPU has not been formatted yet. The program stored on the programmable controller may be broken because the battery gets low. In either case, operate the OP-0 to format the CPU and try to write the program to the programmable controller again. (This message will appear only when the programmable controller is the FP10S or FP10.)
PROGRAM ERR	
PROGRAM ERR	
PROGRAM ERR	
PROGRAM ERR	
プログラム エラー	

Communication Error

Link Error

The following error messages will appear when you operate remote programming using the Link Units. Errors are detected at the Link Unit installed on the programmable controller with which the FP Programmer II is connected.

Notes:

- The Link Unit described in the table below indicates that the Link Unit which is installed on the programmable controller with which the FP Programmer II is trying to communicate via the Link Unit.

Error Message	Action
LINK ERR !21	NACK error. The Link Unit does not recognize the data correctly. Refer to the Link Unit Manual for details.
LINK ERR !21	
LINK ERR !21	
LINK ERR !21	
LINK ERR !21	
リンクエラー !21	
LINK ERR !22	WACK error. The Receive Buffer of the Link Unit is full. Refer to the Link Unit Manual for details.
LINK ERR !22	
LINK ERR !22	
LINK ERR !22	
LINK ERR !22	
リンクエラー !22	
LINK ERR !23	Duplicate board error. The Link Unit number is duplicated with other Link Unit. The Link Unit number must be unique in a network. Assign the unique number for each Link Unit.
LINK ERR !23	
LINK ERR !23	
LINK ERR !23	
LINK ERR !23	
リンクエラー !23	
LINK ERR !24	Transmission format error. The data you are going to send is not corresponding to the transmission format. Refer to the Link Unit Manual for details.
LINK ERR !24	
LINK ERR !24	
LINK ERR !24	
LINK ERR !24	
リンクエラー !24	
LINK ERR !25	Hardware error. Any error occurred on the communication hardware. Refer to the Link Unit Manual for details.
LINK ERR !25	
LINK ERR !25	
LINK ERR !25	
LINK ERR !25	
リンクエラー !25	

Appendix A Error Messages

Error Message	Action
LINK ERR !26	Unit No. error. When your Link Unit is MEWNET-P Link Unit, assign the unit number in the range of 1 to 63. When it is MEWNET-W Link, assign it in the range of 1 to 32. When it is the MEWNET-H Link, set the unit number in the range of 1 to 64.
LINK ERR !26	
LINK ERR !26	
LINK ERR !26	
LINK ERR !26	
リンク エラー !26	
LINK ERR !27	Not support error. You specified the command or the unit which the Link Unit does not support. Refer to the Link Unit Manual for details.
LINK ERR !27	
LINK ERR !27	
LINK ERR !27	
LINK ERR !27	
リンク エラー !27	
LINK ERR !28	No answer error(time out). The unit which you are going to send data does not exist. Refer to the Link Unit Manual for details.
LINK ERR !28	
LINK ERR !28	
LINK ERR !28	
LINK ERR !28	
リンク エラー !28	
LINK ERR !29	Buffer close error. You tried to send or receive data with the buffer closed. Refer to the Link Unit Manual for details.
LINK ERR !29	
LINK ERR !29	
LINK ERR !29	
LINK ERR !29	
リンク エラー !29	
LINK ERR !30	Time out error. You cannot send any data. Check if the optical fiber cable is connected correctly.
LINK ERR !30	
LINK ERR !30	
LINK ERR !30	
LINK ERR !30	
リンク エラー !30	

When the FP Programmer II is Communicating with the Programmable Controller

Error Message	Action
COM. ERROR !40	BCC error. Transmission error occurred in command data. Check the cable connection. Clear the error by pressing the CLR key or the ACLR key. You can continue the operation. If the error often occurs, check the communication cable and contact your dealer.
COM. ERROR !40	
COM. ERROR !40	
COM. ERROR !40	
コマン ドエラー	
COM. ERROR !41	Format error. The command message does not fit to the transmission format. Check the cable connection. Clear the error by pressing the CLR key or the ACLR key. You can continue the operation. If the error often occurs, check the communication cable and contact your dealer.
COM. ERROR !41	
COM. ERROR !41	
COM. ERROR !41	
COM. ERROR !41	
コマン ドエラー	
CANT SUPPORT !42	Not support error. You specified the command or the unit which your programmable controller does not support. Check the version of the programmable controller.
UNMOEGELICH !42	
NON SUPPORTA !42	
NON SUPPORTE !42	
NO SOPORTE !42	
サポ ート シテイマセ	
COM. ERROR !43	Procedure error. Another command is sent while the programmable controller is in the wait state. Clear the error by pressing the CLR key or the ACLR key. You can continue the operation. If the error often occurs, check the communication cable and contact your dealer.
COM. ERROR !43	
COM. ERROR !43	
COM. ERROR !43	
COM. ERROR !43	
コマン ドエラー	
COM. ERROR	Communication error. Clear the error by pressing the CLR key or the ACLR key. You can continue the operation. If the error often occurs, check the communication cable and contact your dealer.
COM. ERROR	
COM. ERROR	
COM. ERROR	
COM. ERROR	
コマン ドエラー	
CANT SEND	Send disable error. Clear the error by pressing the CLR key or the ACLR key. You can continue the operation. If the error often occurs, check the communication cable and contact your dealer.
CANT SEND	
CANT SEND	
CANT SEND	
CANT SEND	
コマン ドエラー	
NO RESPONSE	No response error (time up). Clear the error by pressing the CLR key or the ACLR key. You can continue the operation. If the error often occurs, check the communication cable and contact your dealer. For the FP10S and FP10, this message will appear when you turn on the programmable controller in the RUN mode or when you change the mode of programmable controller from PROG. mode to RUN mode. This is not an error and the message will be cleared after a few minutes.
KEINE ANTWORT	
NO RISPOSTA	
NON REPONSSE	
NO RESPUESTA	
オウオウ ナシ エラー	

When Communicating with the Linked Station

Error Message	Action
NO LINK NO. !50	No link error. You specified the Link Unit number which does not exist in the network. Specify the correct Link Unit number.
NO LINK NO. !50	
NO LINK NO. !50	
NO LINK NO. !50	
NO LINK NO. !50	
リンク NO. ナシ !50	
CANT TRANSMIT !51	Simultaneous operation error. The Send Buffer is full and you cannot send the data to the other Link Unit. Try the operation again. If the same message appears even if you tried several times, contact your dealer.
KEIN SENDEN !51	
TX NON POSS !51	
TRANS. IMPOSS !51	
TX NO POSSIBLE !51	
送信機が送信不能 !51	
CANT TRANSMIT !52	Sending disable error. You cannot send the data to the other Link Unit. The reason is not clear. Try the operation again. If the same message appears even if you tried several times, contact your dealer.
KEIN SENDEN !52	
TX NON POSS !52	
TRANS. IMPOSS !52	
TX NO POSSIBLE !52	
送信機が送信不能 !52	
BUSY ERR !53	Busy error. The programmable controller is now processing a command and cannot receive the data. Wait for the programmable controller to complete that command, and try the operation again.
SYS.UEBERLAST !53	
ERR OCCUPATO !53	
SYS OCCUPE !53	
ERR OCUPADO !53	
ヒューズエラー !53	

When Operating FP Programmer II

Error Message	Action
PARAMETER ERR !60	You entered the wrong parameter. You specified the function which is not supported. If you were entering the password, you might enter a wrong one. Specify the correct parameter, function or password.
PARAM.FEHLER !60	
ERR PARAMETRO !60	
PARAMETRE ERR !60	
ERR PARAMETRO !60	
パラメータエラー !60	
DATA ERR !61	Data error. The relay(contact) or register you entered is invalid. The relay number or the register number you entered is out of the applicable range. Enter the relay or register correctly referring to the Programming Manual for your programmable controller.
DATA ERR !61	
DATA ERR !61	
DATA ERR !61	
DATA ERR !61	
データエラー !61	
ENTRY ERR !62	Registration error. You tried to register too much data. You cannot register any more. You have not registered the required data. Enter the data.
ENTRY ERR !62	
ENTRY ERR !62	
ENTRY ERR !62	
ENTRY ERR !62	
エントリーエラー !62	
PLC MODE ERR !63	Mode error of programmable controller. You cannot execute the operation in the current mode of programmable controller. Change to the correct mode of programmable controller for that operation and try it again. When you are going to edit the program while the programmable controller is in the RUN mode, operate the OP-14 so that you can access to the running program. This message will be also displayed when you try to operate the OP-74(cancel the password) though you have not set the password yet.
SPS MODEFEHLE !63	
ERR MODE PLC !63	
MODE PLC ERR !63	
ERR MODE PLC !63	
モードエラー !63	
MEMR UNIT ERR !64	No ROM/RAM error. The user ROM or the comment RAM is not mounted on the programmable controller. Mount it on the programmable controller and try it again.
FEHLSPEICHER !64	
ERR UNITA MEM !64	
UNITE MEM DEF !64	
ERR MEMORIA !64	
メモリユニットエラー !64	
PROTECT ERR !65	Protect error. The programmable controller is write-protected with the memory protect switch on the CPU. Cancel the protection using the switch. For more information about the memory protection switch, refer to "Installing the ROM" section in the Technical Manual for your programmable controller. The password has been set to the programmable controller. Operate the OP-72 to make the programmable controller registration open state.
SCHUTZFEHLER !65	
ERR PROTEZ !65	
ERR PROTECT !65	
ERR PROTEGIDO !65	
プロテクトエラー !65	
ADDRESS ERR !66	Address error. You specified an address which is out of the program area. Enter an address number correctly, referring to the Programming Manual for your programmable controller.
ADRESSEFEHLER !66	
ERR INDIRIZZO !66	
ADRESSE ERR !66	
ERR DIRECCION !66	
アドレスエラー !66	

Appendix A Error Messages

Error Message	Action
NO DATA ERR !67	Missing data error. The data you want to read from the programmable controller does not exist.
KEINE DATEN !67	
ERR NO DATO !67	
DONNEE ABSC !67	
ERR NO DATOS !67	
データなしエラー !67	
RUN EDIT ERR !68	You cannot edit the program in the RUN mode. To change the instruction stored on the programmable controller, change the mode of programmable controller to the PROG. mode.
FUN-ING.FEHL !68	
ERR RUN EDIT !68	
EDIT RUN ERR !68	
ERR EDIT RUN !68	
ランエディットエラー !68	
PROGRAM FULL !70	The program size exceeds the maximum. Modify the program so that the program size becomes smaller.
PROGRAM FULL !70	
PROGRAM FULL !70	
PROGRAM FULL !70	
PROGRAM FULL !70	
プログラムフル !70	
BUSY ERR !71	The CPU is processing other command and cannot receive the data. Try the operation again.
SYS.VEBERLAST !71	
ERR OCCUPATO !71	
SYS OCCUPE !71	
ERR OCCUPADO !71	
ビジー エラー !71	
PLC TYPE ERROR	The program and the system register parameters stored in the FP Programmer II is not supported by the programmable controller to which the FP Programmer II is now connected. So, you cannot write them to the programmable controller. You can store only the program and the system register values which is made or set for that type of programmable controller.
FALSCHER SPS TYP	
ERRORE TIPO PLC	
ERREUR TYPE PLC	
ERROR TIPO PLC	
キシュチカ'イ エラー	
CAPACITY OVER	The program you tried to upload from the programmable controller is more than 12 kilosteps. The total steps of the program and the system registers to be uploaded from the programmable controller to the FP Programmer II must be 12 kilosteps or less.
PROG.IST ZU LANG	
OLTRE CAPACITA	
DEPASSE CAPACITE	
MEMORIA SATURADA	
プログラムヨウリョウ エラー	
BACKUP POWER ERR	The program or the system register values you uploaded was lost because the battery gets low. Charge the FP Programmer II and upload the program again. You tried to write the data which does not exists in the FP Programmer II. For example, you read only the program from the programmable controller and write the system register values.
BATTERIE-ALARM	
ERR ALIM. BACKUP	
ERREUR ALIM SECO	
BATERIA DESCARG.	
バックアップ' パワー'キレ	

Error Message	Action
PLC MODE ERR	You operated in the wrong mode of programmable controller. For example, you tried to download the program while the programmable controller is in the RUN mode. Change the mode of programmable controller to the correct mode.
SPS MODEFEHLE	
ERR MODE PLC	
MODE PLC ERR	
ERR MODE PLC	
PC モードエラー	
VERIFY ERROR	The data in the FP Programmer II and the one in the programmable controller does not match.
FALSCHER TEST	
ERRORE VERIFICA	
ERREUR VERIF	
ERROR VERIFECA	
データ不一致エラー	

A-2 Self-diagnostic Error Codes

When the OP-110 is executed, and the FP Programmer II detects an error, it will display the corresponding self-diagnostic error code. To identify the error code with the contents of the error and action you should take, refer to the table below.

Note that the self-diagnostic codes E100 to E299 is the codes which is set with the F148(ERR) or P148(PERR) (self-diagnostic error set instruction). They are not listed in the following tables.

If the corresponding error occurs, the message will be displayed like "E100." For more information about the F148 and P148, refer to the Programming Manual for your programmable controller.

The messages will be displayed in the language you have previously selected with the OP-70. In the tables, the messages are listed in English, German, Italian, French, Spanish and Japanese in that order.

Self-diagnostic Code	Action
ERR E20	BPU error. Contact your dealer.
ERR E20	
ERR E20	
ERR E20	
ERR E20	
ERR E20	
ERR E21	RAM error 1. Contact your dealer.
ERR E21	
ERR E21	
ERR E21	
ERR E21	
ERR E21	
ERR E22	RAM error 2. Contact your dealer.
ERR E22	
ERR E22	
ERR E22	
ERR E22	
ERR E22	
ERR E23	RAM error 3. Contact your dealer.
ERR E23	
ERR E23	
ERR E23	
ERR E23	
ERR E23	
ERR E24	RAM error 4. Contact your dealer.
ERR E24	
ERR E24	
ERR E24	
ERR E24	
ERR E24	

Self-diagnostic Code	Action
ERR E25	RAM error 5. Contact your dealer.
ERR E25	
ERR E25	
ERR E25	
ERR E25	
ERR E25	
USER ROM ERR E26	User ROM summation check error. Check the contents in the ROM.
USER ROM ERR E26	
USER ROM ERR E26	
USER ROM ERR E26	
USER ROM ERR E26	
ユーザROMエラー E26	
SP UNIT LAY E27	The number of Intelligent Units mounted on the programmable controller exceeds the maximum. Refer to the manual for the Intelligent Unit to check the maximum number of the Intelligent Units you can mount on one programmable controller.
SOND.MOD.SET E27	
SP UNIT LAY E27	
EXC. UNIT SP E27	
SP UNIT LAY E27	
SP ユニット LAY E27	
SYSTEM REG. E28	The system register error. A value set in the system registers is incorrect. Check the system registers and correct them.
SYSTEM REG. E28	
REG SISTEMA E28	
REG. SYSTEM E28	
REG SISTEMA E28	
システムレジスタ E28	
ERR E29	System bus time out occurs. Contact your dealer.
ERR E29	
ERR E29	
ERR E29	
ERR E29	
ERR E29	
INT ERR 0 E30	Interruption error 0. Contact your dealer.
INT ERR 0 E30	
INT ERR 0 E30	
INT ERR 0 E30	
INT ERR 0 E30	
割りこみエラー 0 E30	
INT ERR 1 E31	Interruption error 1. An interruption occurred though the Interrupt Unit did not request the interruption. An error was generated on other unit, or a other unit might be under the malfunction due to the noise. Check each unit on the programmable controller and make sure if the noise is generated.
INT ERR 1 E31	
INT ERR 1 E31	
INT ERR 1 E31	
INT ERR 1 E31	
割りこみエラー 1 E31	

Self-diagnostic Code	Action
INT ERR 2 E32	Interruption error 2. Create the program which supports the interruption.
INT ERR 2 E32	
INT ERR 2 E32	
INT ERR 2 E32	
INT ERR 2 E32	
INT ERR 2 E32	
ERR E33	Multi-CPU system register error. The parameters of the system registers No.420 and No.443 for the CPU 1 does not match those for the CPU 2. Set the same data for the CPU 1 and CPU2.
ERR E33	
ERR E33	
ERR E33	
ERR E33	
ERR E33	
ERR E34	I/O Unit status error. Any of the units on the programmable controller malfunctions. To know the slot number on which the error was generated, operate the OP-8 to see the contents of DT9036 (for the FP10S and FP10, DT90036). Replace the malfunctioning unit with the new one.
ERR E34	
ERR E34	
ERR E34	
ERR E34	
ERR E34	
REMOTE I/O E35	The unit which cannot be mounted on the slave station is mounted on the slave station. Remove it.
REMOTE I/O E35	
REMOTE I/O E35	
REMOTE I/O E35	
REMOTE I/O E35	
リモート I/O E35	
REMOTE I/O E36	The number of slots or the number of I/Os on the slave station exceeds the maximum. Check the maximum number of the slots and the I/Os for the slave station referring to the remote I/O system manual. Use the slots and the I/Os in the range which the slave station supports.
REMOTE I/O E36	
REMOTE I/O E36	
REMOTE I/O E36	
REMOTE I/O E36	
リモート I/O E36	
REMOTE I/O E37	The I/O numbers in the remote I/O system are duplicated. Allocate the I/O map for the remote I/O system so that no I/O number is duplicated.
REMOTE I/O E37	
REMOTE I/O E37	
REMOTE I/O E37	
REMOTE I/O E37	
リモート I/O E37	
REMOTE I/O E38	The number of I/O points for the I/O terminal board is assigned incorrectly on the I/O map. Referring to the remote I/O system manual and allocate the I/O map correctly.
REMOTE I/O E38	
REMOTE I/O E38	
REMOTE I/O E38	
REMOTE I/O E38	
リモート I/O E38	

Self-diagnostic Code	Action
ERR E39	The IC Memory Card is not installed on the programmable controller. Install one correctly. The data in the IC Memory Card may be broken. Store the data to the IC Memory Card again.
ERR E39	
ERR E39	
ERR E39	
ERR E39	
ERR E39	
I/O FUSE CUT E40	The fuse on the Output Unit was blown. Replace the fuse with the new one.
SICHERUNGDEF E40	
FUSE ROTTO E40	
FUSIBLE DEF E40	
FUSIBLE ROTO E40	
I/O ヒューズ切れ E40	
SP UNIT CPU E41	The Intelligent Unit hangs. An error occurs on that Intelligent Unit. You can make sure on which Intelligent Unit the error occurs by checking the DT9006 and DT9007 (for the FP10S and FP10, DT 90006 and 90007) using the OP-8 function. For details of the error, refer to the manual for the Intelligent Unit.
SOND.MOD.CPU E41	
SP UNITA CPU E41	
DEF. UNITE SP E41	
SP UNIT CPU E41	
SP ユニット CPU E41	
I/O VERIFY E42	I/O verify error. The actual I/O units location does not match the I/O map on the programmable controller. You might remove or install units with the programmable controller turned ON. Turn OFF the programmable controller once and turn it ON again. Then, the new I/O map will be read to the CPU and you will be able to operate again.
EIN/AUS TEST E42	
VERIFICA I/O E42	
VERIF E/S E42	
VERIFICA I/O E42	
I/O 検証エラー E42	
WDT TIME UP E43	The scan time of the program is too long. Modify the program so that it is processed in the shorter time.
WDT VERGEHEN E43	
TEMPO TRASC E43	
WDT DEPASSE E43	
RETRASO WDT E43	
WDT タイムアップ E43	
FUNCTION ERR E45	The program is coded illogically. For example, the register value overflowed as the result of the calculation with the index register (IX or IY). Modify the program so that it is coded logically. To know the address where the error exists, check the DT9017 and DT9018 (for the FP10S and FP10, DT90017 and DT90018) by operating the OP-8.
FUNK.FEHLER E45	
ERR FUNZIONE E45	
FONCTION ERR E45	
ERR FUNCION E45	
ファンクションエラー E45	
REMOTE I/O E46	Any station in the remote I/O system may be still turned OFF. The communication cable may not be connected correctly. For the details of that error, check the DT9131 to DT9137 (for the FP10S and FP10, DT90131 to DT90137) by operating the OP-8. To set the programmable controller so that you can check the slave station errors, refer to Remote I/O System Manual.
REMOTE I/O E46	
REMOTE I/O E46	
REMOTE I/O E46	
REMOTE I/O E46	
リモート I/O E46	

Self-diagnostic Code	Action
REMOTE I/O E47	The I/O Units mounted on the programmable controller does not match the I/O map. The fuse on any unit blew or any intelligent unit malfunctions. Check all the units on the programmable controller.
REMOTE I/O E47	
REMOTE I/O E47	
REMOTE I/O E47	
REMOTE I/O E47	
リモート I/O E47	
BATTERY ERR E50	The voltage of the battery is getting low. Replace it with the new one.
BATT. FEHLER E50	
ERR BATTERIA E50	
DEFAUT PILE E50	
ERR BATERIA E50	
バッテリーエラー E50	
REMOTE I/O E51	Remote I/O terminator error. Terminator is set incorrectly. Correct it referring to the Remote I/O System Manual.
REMOTE I/O E51	
REMOTE I/O E51	
REMOTE I/O E51	
REMOTE I/O E51	
リモート I/O E51	
REMOTE I/O E52	Remote I/O refresh synchronization error. Contact your dealer.
REMOTE I/O E52	
REMOTE I/O E52	
REMOTE I/O E52	
REMOTE I/O E52	
リモート I/O E52	
ERR E53	In the multi-CPU system, the I/O map stored to the CPU 1 does not match the one stored to the CPU 2. The same I/O maps must exist both on the CPU 1 and CPU 2. You can store the I/O map using the OP-52.
ERR E53	
ERR E53	
ERR E53	
ERR E53	
ERR E53	
ERR E54	IC card battery error. The main battery in the IC Memory Card gets low. The data in the IC Memory Card will not be lost because it is still kept by the sub battery. But you must replace the main battery with the new one as soon as possible, or you will lost the data.
ERR E54	
ERR E54	
ERR E54	
ERR E54	
ERR E54	
ERR E55	IC card battery error. Both the main battery and the sub battery in the IC Memory Card get low. The data in the IC Memory Card will be lost. Replace both battery with the new ones.
ERR E55	
ERR E55	
ERR E55	
ERR E55	
ERR E55	

Appendix B List of Instructions

B-1 Basic Instructions

B-1-1 Basic Sequence Instructions

Instruction Names		Descriptions	Type of programmable controller							
			FP1 C14 C16	C24 C40	C56 C72	FP3	FP5	FP10S FP10	FP-M	FP-C
ST	Start	Begins a logic operation with a Form A(normally open) contact.								
ST/	Start not	Begins a logic operation with a Form B(normally closed) contact.								
OT	Out	Outputs the operated result.								
/	Not	Inverts the operated condition.								
AN	AND	Connects a Form A(normally open) contact in series.								
AN/	AND not	Connects a Form B(normally closed) contact in series.								
OR	OR	Connects a Form A(normally open) contact in parallel.								
OR/	OR not	Connects a Form B(normally closed) contact in parallel.								
ANS	AND stack	Connects instruction blocks in series.								
ORS	OR stack	Connects instruction blocks in parallel.								
PSHS	Push stack	Stores the operated condition before this instruction.								
RDS	Read stack	Reads the operated condition stored by the push stack instruction (PSHS).								
POPS	Pop stack	Reads and resets the operated condition stored by the push stack instruction(PSHS).								
KP	Keep	Turns ON the output and maintains its condition.								
NOP	Not operation	Not operation								
DF	Leading edge differential	Turns ON the contact only when the leading edge of the trigger is detected.								
DF/	Trailing edge differential	Turns ON the contact only when the trailing edge of the trigger is detected.								
SET	Set	Turns output ON when the executing condition is satisfied.				*	N/A			
RST	Reset	Turns output OFF when the executing condition is satisfied.				*	N/A			

* : The FP3 whose part number has the suffix C.

Null: Available
N/A: Not available

B-1-2 Basic Function Instructions

Instruction Names		Descriptions	Type of programmable controller							
			FP1 C14 C16	C24 C40	C56 C72	FP3	FP5	FP10S FP10	FP-M	FP-C
TM	Timer	Sets the ON-delay timer (for 0.01s unit/0.1s unit/1s unit)								
F137(STMR)	Auxiliary timer	Sets the 0.01s units timer.	N/A	N/A			N/A			
CT	Counter	Sets the Preset(Set) counter (DOWN counter).								
F118(UDC)	UP/DOWN counter	Sets the UP/DOWN counter.								
SR	Shift register (left shift)	Shifts one bit of 16-bit data to the left.								
F119(LRSR)	Left/right shift register	Shifts one bit of 16-bit data range to the left/right.								

Null: Available
N/A: Not available

B-1-3 Control Instructions

Instruction Names		Descriptions	Type of programmable controller							
			FP1 C14 C16	C24 C40	C56 C72	FP3	FP5	FP10S FP10	FP-M	FP-C
MC	Master control relay	Executes the program between the master control relay(MC) and master control relay end(MCE) instructions when the trigger turns ON.								
MCE	Master control relay end									
JP	Jump	Jumps steps to the specified label with the same number when the trigger turns on.								
F19(SJP)	Auxiliary jump	Jumps steps to the label specified by the data area of auxiliary instruction[F19(SJP)] when the trigger turns on.	N/A	N/A	N/A		N/A		N/A	
LOOP	Loop	Jumps steps to the specified label with the same number and repeats the same operation until the set value in the data area becomes "0".								
LBL	Label	Label used for execution of JP and LOOP instruction.								
BRK	Break	Stops the execution during the test run mode.	N/A	N/A	N/A				N/A	
ED	End	Indicates the end of main program.								
CNDE	Conditional end	Ends the scan when the trigger turns ON.								
NSTP	Next step (pulse execution)	Opens the process of the step ladder and resets the process including the instruction itself.								
NSTL	Next step (level execution)	Opens the process of the step ladder and resets the process including the instruction itself.	*	*		*	N/A			
SSTP	Start step	Indicates the start step ladder process.								
CSTP	Clear step	Resets the specified process.								
STPE	Step end	Ends the step ladder area and returns to the normal scan area.								
CALL	Subroutine call	Jumps steps to the specified subroutine.								
SUB	Subroutine entry	Indicates the start of subroutine program.								
RET	Return	Ends the subroutine program and returns to the main program.								
INT	Interrupt	Indicates the start of interrupt program.	N/A							
IRET	Interrupt return	Ends the interrupt program and returns to the normal scan area.	N/A							
ICTL	Interrupt control	Specifies the condition of the interrupt instruction(INT).	N/A							

* : The FP1 whose part number has the suffix A or B.
The FP3 whose part number has the suffix C.

Null: Available
N/A: Not available

B-1-4 Comparison Instructions

Instruction Names		Descriptions	Type of programmable controller								
			FP1 C14 C16	C24 C40	C56 C72	FP3	FP5	FP10S FP10	FP-M	FP-C	
ST =	word start equal	Performs start, AND or OR operation by comparing two word-data in the following condition. ON: when S1 = S2 OFF: when S1 ≠ S2	N/A	*	*	*	N/A	*	*	*	
AN =	word AND equal										
OR =	word OR equal										
ST <>	word start equal not	Performs start, AND of OR operation by comparing two word-data in the following condition. ON: when S1 ≠ S2 OFF: when S1 = S2	N/A	*	*	*	N/A	*	*	*	
AN <>	word AND equal not										
OR <>	word OR equal not										
ST >	word start larger	Performs start, AND or OR operation by comparing two word-data in the following condition. ON: when S1 > S2 OFF: when S1 ≤ S2	N/A	*	*	*	N/A	*	*	*	
AN >	word AND larger										
OR >	word OR larger										
ST >=	word start equal or larger	Performs start, AND or OR operation by comparing two word-data in the following condition. ON: when S1 ≥ S2 OFF: when S1 < S2	N/A	*	*	*	N/A	*	*	*	
AN >=	word AND equal or larger										
OR >=	word OR equal or larger										
ST <	word start smaller	Performs start, AND or OR operation by comparing two word-data in the following condition. ON: when S1 < S2 OFF: when S1 ≥ S2	N/A	*	*	*	N/A	*	*	*	
AN <	word AND smaller										
OR <	word OR smaller										
ST <=	word start equal or smaller	Performs start, AND or OR operation by comparing two word-data in the following condition. ON: when S1 ≤ S2 OFF: when S1 > S2	N/A	*	*	*	N/A	*	*	*	
AN <=	word AND equal or smaller										
OR <=	word OR equal or smaller										
STD =	double word start equal	Performs start, AND or OR operation by comparing two double word-data in the following condition. ON: when (S1+1, S1) = (S2+1, S2) OFF: when (S1+1, S1) ≠ (S2+1, S2)	N/A	*	*	*	N/A	*	*	*	
AND =	double word AND equal										
ORD =	double word OR equal										

* : Available from the version shown below.

FP1: Ver 2.7
 FP3: Ver 4.4
 FP10S: Ver 0.7
 FP10: Ver 0.7
 FP-M: Ver 2.7
 FP-C: Ver 4.4

Null: Available
N/A: Not available

Instruction Names		Descriptions	Type of programmable controller							
			FP1 C14 C16	C24 C40	C56 C72	FP3	FP5	FP10S FP10	FP-M	FP-C
STD <>	double word start equal not	Performs start, AND or OR operation by comparing two double word-data in the following condition. ON: when (S1+1, S1) ≠ (S2+1, S2) OFF:when (S1+1, S1) = (S2+1, S2)	N/A	*	*	*	N/A	*	*	*
AND <>	double word AND equal not									
ORD <>	double word OR equal not									
STD >	double word start larger	Performs start, AND or OR operation by comparing two double word-data in the following condition. ON: when (S1+1, S1) > (S2+1, S2) OFF:when (S1+1, S1) ≤ (S2+1, S2)	N/A	*	*	*	N/A	*	*	*
AND >	double word AND larger									
ORD >	double word OR larger									
STD >=	double word start equal or larger	Performs start, AND or OR operation by comparing two double word-data in the following condition. ON: when (S1+1, S1) ≥ (S2+1, S2) OFF:when (S1+1, S1) < (S2+1, S2)	N/A	*	*	*	N/A	*	*	*
AND >=	double word AND equal or larger									
ORD >=	double word OR equal or larger									
STD <	double word start smaller	Performs start, AND or OR operation by comparing two double word-data in the following condition. ON: when (S1+1, S1) < (S2+1, S2) OFF:when (S1+1, S1) ≥ (S2+1, S2)	N/A	*	*	*	N/A	*	*	*
AND <	double word AND smaller									
ORD <	double word OR smaller									
STD <=	double word start equal or smaller	Performs start, AND or OR operation by comparing two double word-data in the following condition. ON: when (S1+1, S1) ≤ (S2+1, S2) OFF:when (S1+1, S1) > (S2+1, S2)	N/A	*	*	*	N/A	*	*	*
AND <=	double word AND equal or smaller									
ORD <=	double word OR equal or smaller									

* : Available from the version shown below.

FP1: Ver 2.7
 FP3: Ver 4.4
 FP10S: Ver 0.7
 FP10: Ver 0.7
 FP-M: Ver 2.7
 FP-C: Ver 4.4

Null: Available
N/A: Not available

B-2 High Level Instructions

Note:

- Pulse execution type instructions are not available on the FP1.

B-2-1 Data Transfer Instructions

Instruction Names		Descriptions	Type of programmable controller							
			FP1 C14 C16	C24 C40	C56 C72	FP3	FP5	FP10S FP10	FP-M	FP-C
F0(MV) P0(PMV)	16-bit data Move	Copies the specified 16-bit data to another area.								
F1(DMV) P1(PDMV)	32-bit data Move	Copies the specified 32-bit data to another area.								
F2(MV/) P2(PMV/)	16-bit data Invert and move	Inverts the specified 16-bit data and write the inverted result to another area.								
F3(DMV/) P3(PDMV/)	32-bit data Invert and move	Inverts the specified 32-bit data and write the inverted result to another area.								
F5(BTM) P5(PBTM)	Bit data Move	Copies a bit of the specified 16-bit data to one of another 16-bit area.								
F6(DGT) P6(PDGT)	Hexadecimal digit Move	Copies the hexadecimal digits from one 16-bit data area to another.								
F10(BKMV) P10(PBKMV)	Block Move	Copies the data block to the specified area.								
F11(COPY) P11(PCOPY)	Block Copy	Copies the specified 16-bit data to the block with one or more 16-bit area.								
F12(ICRD) P12(PICRD)	Data Read from IC Memory Card	Reads data from the IC memory card.	N/A	N/A	N/A	N/A	N/A		N/A	N/A
F13(ICWT) P13(PICWT)	Data Write to IC Memory Card	Writes data from the IC memory card.	N/A	N/A	N/A	N/A	N/A		N/A	N/A
F14(PGRD) P14(PPGRD)	Program Read from IC Memory Card	Reads program from the IC memory card.	N/A	N/A	N/A	N/A	N/A		N/A	N/A
F15(XCH) P15(PXCH)	16-bit data Exchange	Exchanges two 16-bit data.								
F16(DXCH) P16(PDXCH)	32-bit data Exchange	Exchanges two 32-bit data.								
F17(SWAP) P17(PSWAP)	High/low bytes Exchange	Exchanges high and low order bytes of the specified 16-bit data.								

Null: Available
N/A: Not available

B-2-2 BIN Arithmetic Instructions

Instruction Names		Descriptions	Type of programmable controller							
			FP1 C14 C16	C24 C40	C56 C72	FP3	FP5	FP10S FP10	FP-M	FP-C
F20(+) P20(P+)	16-bit data [D+S→D]	Adds two 16-bit data and stores the result into the augend area.								
F21(D+) P21(PD+)	32-bit data [(D+1,D)+(S+1,S) →(D+1,D)]	Adds two 32-bit data and stores the result into the augend area.								
F22(+) P22(P+)	16-bit data [S1+S2→D]	Adds two 16-bit data and stores the result into the specified area.								
F23(D+) P23(PD+)	32-bit data [(S1+1,S1)+ (S2+1,S2)→(D+1,D)]	Adds two 32-bit data and stores the result into the specified area.								
F25(-) P25(P-)	16-bit data [D-S→D]	Subtracts the 16-bit data from the minuend and stores the result into the minuend area.								
F26(D-) P26(PD-)	32-bit data [(D+1,D)-(S+1,S) →(D+1,D)]	Subtracts the 32-bit data from the minuend and stores the result into the minuend area.								
F27(-) P27(P-)	16-bit data [S1-S2→D]	Subtracts the 16-bit data from the minuend and stores the result into the specified area.								
F28(D-) P28(PD-)	32-bit data [(S1+1,S1)-(S2+1,S2) →(D+1,D)]	Subtracts the 32-bit data from the minuend and stores the result into the specified area.								
F30(*) P30(P*)	16-bit data [S1×S2→(D+1,D)]	Multiplies two 16-bit data and stores the result into the specified 32-bit area.								
F31(D*) P31(PD*)	32-bit data [(S1+1,S1)×(S2+1,S2) →(D+3,D+2,D+1,D)]	Multiplies two 32-bit data and stores the result into the specified 64-bit area.	N/A							
F32(%) P32(P%)	16-bit data [S1/S2→D... (DT9015)]	Divides the 16-bit data by the divisor and stores the result and remainder into the specified areas.								
F33(D%) P33(PD%)	32-bit data [(S1+1,S1)/(S2+1,S2) →(D+1,D)... (DT9016,DT9015)]	Divides the 32-bit data by the divisor and stores the result and remainder into the specified areas.	N/A							
F35(+1) P35(P+1)	16-bit data increment [D+1→D]	Adds 1 to the 16-bit data and stores the result into the augend area.								
F36(D+1) P36(PD+1)	32-bit data increment [(D+1,D)+1 →(D+1,D)]	Adds 1 to the 32-bit data and stores the result into the augend area.								
F37(-1) P37(P-1)	16-bit data decrement [D-1→D]	Subtracts 1 from the 16-bit data and stores the result into the minuend area.								
F38(D-1) P38(PD-1)	32-bit data decrement [(D+1,D)-1 →(D+1,D)]	Subtracts 1 from the 32-bit data and stores the result into the minuend area.								
F160(DSQR) P160(PDSQR)	32-bit data square root [$\sqrt{S+1,S}$ →(D+1,D)]	Finds the square root of the 32-bit data and stores the specified 32-bit area.	N/A	N/A	N/A					N/A

Null: Available
N/A: Not available

B-2-3 BCD Arithmetic Instructions

Instruction Names		Descriptions	Type of programmable controller							
			FP1 C14 C16	C24 C40	C56 C72	FP3	FP5	FP10S FP10	FP-M	FP-C
F40(B+) P40(PB+)	4-digit BCD [D+S→D]	Adds two 4-digit BCD data and stores the result into the augend area.								
F41(DB+) P41(PDB+)	8-digit BCD [(D+1,D)+(S+1,S) →(D+1,D)]	Adds two 8-digit BCD data and stores the result into the augend area.								
F42(B+) P42(PB+)	4-digit BCD [S1+S2→D]	Adds two 4-digit BCD data and stores the result into the specified area.								
F43(DB+) P43(PDB+)	8-digit BCD [(S1+1,S1)+(S2+1,S2) →(D+1,D)]	Adds two 8-digit BCD data and stores the result into the specified area.								
F45(B-) P45(PB-)	4-digit BCD [D-S→D]	Subtracts the 4-digit BCD data from the minuend and stores the result into the minuend area.								
F46(DB-) P46(PDB-)	8-digit BCD [(D+1,D)-(S+1,S) →(D+1,D)]	Subtracts the 8-digit BCD data from the minuend and stores the result into the minuend area.								
F47(B-) P47(PB-)	4-digit BCD [S1-S2→D]	Subtracts the 4-digit BCD data from the minuend and stores the result into the specified area.								
F48(DB-) P48(PDB-)	8-digit BCD [(S1+1,S1)-(S2+1,S2) →(D+1,D)]	Subtracts the 8-digit BCD data from the minuend and stores the result into the specified area.								
F50(B*) P50(PB*)	4-digit BCD [S1×S2→(D+1,D)]	Multiplies two 4-digit BCD data and stores the result into the specified 8-digit BCD area.								
F51(DB*) P51(PDB*)	8-digit BCD [(S1+1,S1)×(S2+1,S2) →(D+3,D+2,D+1,D)]	Multiplies two 8-digit BCD data and stores the result into the specified 16-digit BCD area.	N/A							
F52(B%) P52(PB%)	4-digit BCD [S1/S2→D... (DT9015)]	Divides the 4-digit BCD data by the divisor and stores the result and remainder into the specified areas.								
F53(DB%) P53(PDB%)	8-digit BCD [(S1+1,S1)/(S2+1,S2) →(D+1,D)... (DT9016,DT9015)]	Divides the 8-digit BCD data by the divisor and stores the result and remainder into the specified areas.	N/A							
F55(B+1) P55(PB+1)	4-digit BCD increment [D+1→D]	Adds 1 to the 4-digit BCD data and stores the result into the augend area.								
F56(DB+1) P56(PDB+1)	8-digit BCD increment [(D+1,D)+1 →(D+1,D)]	Adds 1 to the 8-digit BCD data and stores the result into the augend area.								
F57(B-1) P57(PB-1)	4-digit BCD decrement [D-1→D]	Subtracts 1 from the 4-digit BCD data and stores the result into the minuend area.								
F58(DB-1) P58(PDB-1)	8-digit BCD decrement [(D+1,D)-1 →(D+1,D)]	Subtracts 1 from the 8-digit BCD data and stores the result into the minuend area.								

Null: Available
N/A: Not available

B-2-4 Data Comparison Instructions

Instruction Names		Descriptions	Type of programmable controller							
			FP1 C14 C16	C24 C40	C56 C72	FP3	FP5	FP10S FP10	FP-M	FP-C
F60(CMP) P60(PCMP)	16-bit data Compare	Compares one 16-bit data with another one.								
F61(DCMP) P61(PDCMP)	32-bit data Compare	Compares one 32-bit data with another one.								
F62(WIN) P62(PWIN)	16-bit data range Compare	Compares one 16-bit data with the range specified by two other 16-bit data.								
F63(DWIN) P63(PDWIN)	32-bit data range Compare	Compares one 32-bit data with the range specified by two other 32-bit data.								
F64(BCMP) P64(PBCMP)	Same block Detect	Detects the same block.	*	*		*	N/A			

* : The FP1 whose part number has the suffix A.
The FP3 whose part number has the suffix C.

Null: Available
N/A: Not available

B-2-5 Logic Operation Instructions

Instruction Names		Descriptions	Type of programmable controller							
			FP1 C14 C16	C24 C40	C56 C72	FP3	FP5	FP10S FP10	FP-M	FP-C
F65(WAN) P65(PWAN)	16-bit data AND	Executes AND operation of each bit in two 16-bit data.								
F66(WOR) P66(PWOR)	16-bit data OR	Executes OR operation of each bit in two 16-bit data.								
F67(XOR) P67(PXOR)	16-bit data Exclusive OR	Executes exclusive OR operation of each bit in two 16-bit data.								
F68(XNR) P68(PXNR)	16-bit data Exclusive NOR	Executes exclusive NOR operation of each bit in two 16-bit data.								

Null: Available
N/A: Not available

B-2-6 Data Conversion Instructions

Instruction Names		Descriptions	Type of programmable controller							
			FP1 C14 C16	C24 C40	C56 C72	FP3	FP5	FP10S FP10	FP-M	FP-C
F70(BCC) P70(PBCC)	Block check code calculation	Calculates block check codes (ADD,SUB,XOR)	N/A			*	N/A			
F71(HEXA) P71(PHEXA)	HEX to HEX ASCII conversion	Converts hexadecimal data to hexadecimal ASCII codes.	N/A			*	N/A			
F72(AHEX) P72(PAHEX)	HEX ASCII to HEX conversion	Converts hexadecimal ASCII codes to hexadecimal data.	N/A			*	N/A			
F73(BCDA) P73(PBCDA)	BCD to DEC ASCII conversion	Converts the specified BCD data to decimal ASCII codes.	N/A			*	N/A			
F74(ABCD) P74(PABCD)	DEC ASCII to BCD conversion	Converts the specified decimal ASCII codes to BCD data.	N/A			*	N/A			
F75(BINA) P75(PBINA)	BIN to DEC ASCII conversion	Converts 16-bit binary data to decimal ASCII codes.	N/A			*	N/A			
F76(ABIN) P76(PABIN)	DEC ASCII to BIN conversion	Converts the specified decimal ASCII codes to 16-bit binary data.	N/A			*	N/A			
F77(DBIA) P77(PDBIA)	BIN to DEC ASCII conversion	Converts the specified 32-bit binary data to decimal ASCII codes.	N/A			*	N/A			
F78(DABI) P78(PDABI)	DEC ASCII to BIN conversion	Converts the specified decimal ASCII codes to 32-bit binary data.	N/A			*	N/A			
F80(BCD) P80(PBCD)	16-bit data →4-digit BCD	Converts the 16-bit binary data to 4-digit BCD data.								
F81(BIN) P81(PBIN)	4-digit BCD →16-bit data	Converts the 4-digit BCD data to 16-bit binary data.								
F82(DBCD) P82(PDBCD)	32-bit data →8-digit BCD	Converts the 32-bit binary data to 8-digit BCD data.								
F83(DBIN) P83(PDBIN)	8-digit BCD →32-bit data	Converts the 8-digit BCD data to 32-bit binary data.								
F84(INV) P84(PINV)	16-bit data Invert	Inverts the 16-bit data.								
F85(NEG) P85(PNEG)	16-bit data Two's complement	Gets two's complement of 16-bit data.								
F86(DNEG) P86(PDNEG)	32-bit data Two's complement	Gets two's complement of 32-bit data.								
F87(ABS) P87(PABS)	16-bit data Absolute	Gets absolute value of 16-bit data.								
F88(DABS) P88(PDABS)	32-bit data Absolute	Gets absolute value of 32-bit data.								
F89(EXT) P89(PEXT)	16-bit data Sign extension	Copies the sign bit of the specified 16-bit data to all the bits of the 16-bit area with one higher area No.								
F90(DECO) P90(PDECO)	Decode	Decodes the specified data.								
F91(SEGT) P91(PSEGT)	16-bit data 7-segment decode	Converts 16-bit data to 4-digit data for 7-segment indication.								
F92(ENCO) P92(PENCO)	Encode	Encodes the specified data.								

* : The FP3 whose part number has the suffix C.

Null: Available
N/A: Not available

Instruction Names		Descriptions	Type of programmable controller							
			FP1 C14 C16	C24 C40	C56 C72	FP3	FP5	FP10S FP10	FP-M	FP-C
F93(UNIT) P93(PUNIT)	16-bit data Combine	Combines lower 4 bits of 16-bit data(up to 4 data) and stores the result as 16-bit data.								
F94(DIST) P94(PDIST)	16-bit data Distribute	Divides 16-bit data by 4-bit units and stores each 4-bit into the lower 4-bit of the specified 16-bit data.								
F95(ASC) P95(PASC)	Character →ASCII code	Converts characters into the ASCII code.								
F96(SRC) P96(PSRC)	Table data Search	Searches the specified 16-bit data from the specified block.								

Null: Available
N/A: Not available

B-2-7 Data Shift Instructions

Instruction Names		Descriptions	Type of programmable controller							
			FP1 C14 C16	C24 C40	C56 C72	FP3	FP5	FP10S FP10	FP-M	FP-C
F98(CMPR) P98(PCMPR)	Compressed and shifted 16-bit data read	Reads a compressed and shifted 16-bit data.	N/A	N/A	N/A	*	N/A		N/A	
F99(CMPW) P99(PCMPW)	Compressed and shifted 16-bit data write	Writes a compressed and shifted 16-bit data.	N/A	N/A	N/A	*	N/A		N/A	
F100(SHR) P100(PSHR)	16-bit data Right shift	Shifts the specified number of bits to the right in the 16-bit data.								
F101(SHL) P101(PSHL)	16-bit data Left shift	Shifts the specified number of bits to the left in the 16-bit data.								
F105(BSR) P105(PBSR)	16-bit data 1-digit right shift	Shifts one digit(4 bits) of the specified 16-bit data to the right.								
F106(BSL) P106(PBSL)	16-bit data 1-digit left shift	Shifts one digit(4 bits) of the specified 16-bit data to the left.								
F110(WSHR) P110(PWSHR)	Block 1-word right shift	Shifts one word(16-bit) of the specified block to the right.								
F111(WSHL) P111(PWSHL)	Block 1-word left shift	Shifts one word(16-bit) of the specified block to the left.								
F112(WBSR) P112(PWBSR)	Block 1-digit right shift	Shifts one digit(4-bit) of the specified block to the right.								
F113(WBSL) P113(PWBSL)	Block 1-digit left shift	Shifts one digit(4-bit) of the specified block to the left.								

* : The FP3 whose part number has the suffix C.

Null: Available
N/A: Not available

B-2-8 FIFO(First-In-First-Out) Instructions

Instruction Names		Descriptions	Type of programmable controller								
			FP1 C14 C16	C24 C40	C56 C72	FP3	FP5	FP10S FP10	FP-M	FP-C	
F115(FIFT) F115(PFIFT)	FIFO buffer Define	Defines the buffer of FIFO (First-In-First-Out) condition.	N/A	N/A	N/A					N/A	
F116(FIFR) F116(PFIFR)	Data read from FIFO buffer	Reads the data from the FIFO (First-In-First-Out) buffer and stores the data into the specified area.	N/A	N/A	N/A					N/A	
F117(FIFW) F117(PFIFW)	Data write into FIFO buffer	Writes the data into the FIFO (First-In-First-Out) buffer.	N/A	N/A	N/A					N/A	

Null: Available
N/A: Not available

B-2-9 Data Rotate Instructions

Instruction Names		Descriptions	Type of programmable controller								
			FP1 C14 C16	C24 C40	C56 C72	FP3	FP5	FP10S FP10	FP-M	FP-C	
F120(ROR) P120(PROR)	16-bit data Right rotate	Rotates the specified number of bits without carry flag to the right in the 16-bit data.									
F121(ROL) P121(PROL)	16-bit data Left rotate	Rotates the specified number of bits without carry flag to the left in the 16-bit data.									
F122(RCR) P122(PRCR)	16-bit data Right rotate with carry flag	Rotates the specified number of bits with carry flag to the right in the 16-bit data.									
F123(RCL) P123(PRCL)	16-bit data Left rotate with carry flag	Rotates the specified number of bits with carry flag to the left in the 16-bit data.									

Null: Available
N/A: Not available

B-2-10 Bit Manipulation Instructions

Instruction Names		Descriptions	Type of programmable controller								
			FP1 C14 C16	C24 C40	C56 C72	FP3	FP5	FP10S FP10	FP-M	FP-C	
F130(BTS) P130(PBTS)	16-bit data Bit set	Sets the specified bit of 16-bit data.									
F131(BTR) P131(PBTR)	16-bit data Bit reset	Resets the specified bit of 16-bit data.									
F132(BTI) P132(PBTI)	16-bit data Bit invert	Inverts the specified bit of 16-bit data.									
F133(BTT) P133(PBTT)	16-bit data Bit test	Checks the specified bit of 16-bit data.									
F135(BCU) P135(PBCU)	16-bit data Total 1's number	Counts 1's numbers of the specified 16-bit data.									
F136(DBCU) P136(PDBCU)	32-bit data Total 1's number	Counts 1's numbers of the specified 32-bit data.									

Null: Available
N/A: Not available

B-2-11 Special Instructions

Instruction Names		Descriptions	Type of programmable controller							
			FP1 C14 C16	C24 C40	C56 C72	FP3	FP5	FP10S FP10	FP-M	FP-C
F138(HMSS) P138(PHMSS)	Hours/minutes/seconds data to seconds data conversion	Converts hours, minutes and seconds data to seconds data.	N/A			*	N/A			
F139(SHNS) P139(PSHNS)	Seconds to hours/ minutes/seconds data conversion	Converts seconds data to hours, minutes and seconds.	N/A			*	N/A			
F140(STC) P140(PSTC)	Carry flag(R9009) Set	Sets carry flags(R9009).	N/A							
F141(CLC) P141(PCLC)	Carry flag(R9009) Reset	Resets carry flags(R9009).	N/A							
F142(WDT) P142(PWDT)	Watchdog timer Update	Updates the watchdog timer of FP5.	N/A	N/A	N/A	N/A		N/A	N/A	N/A
F143(IORF) P143(PIORF)	Partial I/O Update	Partially updates the I/O points.	N/A							
F145(SEND) P145(PSEND)	Link data Send	Sends the data to the linked Programmable Controller(PC).	N/A	N/A	N/A				N/A	
F146(RECV) P146(PRECV)	Link data Receive	Receives the data from the linked Programmable Controller(PC).	N/A	N/A	N/A				N/A	
F147(PR)	Print out	Outputs 12 characters stored in 6-word data areato the outputs.	N/A							
F148(ERR) P148(PERR)	Self-diagnostic error Set	Sets the specified error code to the special register DT9000.	N/A							
F149(MSG) P149(PMSG)	Message display	Displays the specified characters on the programming tools (FP Programmer/NPST-GR).	N/A							
F150(READ) P150(PREAD)	Data read from advanced units	Reads the data from the specified advanced unit.	N/A	N/A	N/A				N/A	
F151(WRT) P151(PWRT)	Data write into advanced units	Writes the data into the specified advanced unit.	N/A	N/A	N/A				N/A	
F152(RMRD) P152(PRMRD)	Data read from the slave station	Reads the data from the specified advanced unit of the slave station.	N/A	N/A	N/A				N/A	
F153(RMWT) P153(PRMWT)	Data write into the slave station	Writes the data into the specified advanced unit of the slave station.	N/A	N/A	N/A				N/A	
F154(MCAL) P154(PMCAL)	Machine language call	Calls program area of the machine language.	N/A	N/A	N/A				N/A	
F155(SMPL) P155(PSMPL)	Sampling Start	Transfers the sampling data specified by NPST-GR into the sampling memory.	N/A	N/A	N/A				N/A	
F156(STRG) P156(PSTRG)	Sampling Stop	Stops transferring the sampling data to the sampling memory.	N/A	N/A	N/A				N/A	
F157(CADD) P157(PCADD)	Time Add	Adds the time.	N/A	*		*	N/A			
F158(CSUB) P158(PCSUB)	Time Add	Subtracts the time.	N/A	*		*	N/A			

* : The FP1 whose part number has the suffix A or B.
The FP3 whose part number has the suffix C.

Null: Available
N/A: Not available

B-2-12 Special Instructions(High Speed Counter)



Instruction Names		Descriptions	Type of programmable controller							
			FP1 C14 C16	C24 C40	C56 C72	FP3	FP5	FP10S FP10	FP-M	FP-C
F144(TRNS)	Transmission to serial port	Transmits the specified bytes at the sequent area to the specified one from RS-232-C port.	N/A			N/A	N/A	N/A		N/A
F162(HC0S)	ON when the target value agrees	Turns the specified output ON when the elapsed value of HSC agrees with the target value.				N/A	N/A	N/A		N/A
F163(HC0R)	OFF when the target value agrees	Turns the specified output OFF when the elapsed value of HSC agrees with the target value.				N/A	N/A	N/A		N/A
F164(SPD0)	Speed control instruction	Outputs the pattern or the pulse corresponding to the elapsed value of HSC.				N/A	N/A	N/A		N/A
F165(CAM0)	Cam control	Converts ON/OFF of output specified on the table corresponding to the elapsed value of HSC.				N/A	N/A	N/A		N/A

Null: Available
N/A: Not available























































Appendix C Key Operations

This section lists basic key operation for creating/editing a program, for operating functions which the FP Programmer II provides, and for entering instructions name.

Conventions in the tables

- To operate each function, press the keys listed in the table from the left to the right in order, or follow the direction which the arrow shows.
-  shows any of the alphanumeric keys.
-  shows any of the relay/instruction keys.
-  Key which is enclosed with dashed lines indicates an option.

C-1 Basic Key Operations for Creating/Editing a Program

To:	Press:	Refer to:
Read an instruction	  	2. 1
Search for a relay(contact)	    ... 	Reading the instruction 3. 1
Search for a register	     ... 	Reading the instruction 3. 2
Search for an instruction	      ... 	Reading the instruction 3. 3
Write a basic instruction listed on the key	   	4. 1
Write a basic instruction not listed on the key	    	
Write a basic instruction not listed on the key with help function	      	
Write a high level instruction	         Can be repeated twice	
Delete an instruction	 	4. 4
Delete instructions	      	

To:	Press:	Refer to:
Delete an instruction without shifting the addresses	SHIFT SC 1 SHIFT SC WRT	4. 4
Delete an instructions without shifting the addresses	ACLR NO. ENT NO. WRT (HELP) CLR WRT	
Select the OP function	ACLR (-) OP NO. ENT	5. 2
Select the OP function with help function	ACLR (-) OP SHIFT SC (HELP) CLR SRC ▲ ENT READ ▼	

C-2 Basic Key Operation for Operating OP Functions

OP Function Number	Description	Press:	Refer to:
OP-0	Clears Program Area and Hold Areas.	ACLR (-) OP 0 ENT SHIFT SC (DEL) INST	5.3
OP-1	Deletes NOP instructions in the program.	ACLR (-) OP 1 ENT SHIFT SC (DEL) INST	5.4
OP-2, 3, 8	Monitors and changes word data (register values). WX, WY, WR, WL, DT, FL and LD	<p>Monitoring word data</p> <p>ACLR (-) OP 2 ENT SHIFT SC I•R NO. READ</p> <p style="margin-left: 150px;">in decimal</p> <p style="margin-left: 150px;">3</p> <p style="margin-left: 150px;">(BIN) K/H</p> <p style="margin-left: 150px;">in hexadecimal</p> <p style="margin-left: 150px;">8</p> <p style="margin-left: 150px;">SHIFT SC (BIN) K/H</p> <p style="margin-left: 150px;">in binary</p> <hr/> <p>Changing word data</p> <p>(HELP) CLR (BIN) K/H NO. READ</p> <p style="margin-left: 150px;">in decimal</p> <p style="margin-left: 150px;">(BIN) K/H NO. READ</p> <p style="margin-left: 150px;">in hexadecimal</p> <hr/> <p>Clear LCD</p> <p>(HELP) CLR (HELP) CLR</p>	5.5
OP-7	Monitors relays (1 to 4 points). X, Y, R, L, T and C	<p>Monitoring relay</p> <p>ACLR (-) OP 7 ENT I•R NO. ENT I•R NO. READ</p> <p style="margin-left: 150px;">↑</p> <p style="margin-left: 150px;">Can be repeated twice</p> <hr/> <p>Changing a relay</p> <p>SRC (HELP) CLR I•R NO. ENT</p> <hr/> <p>Clear LCD</p> <p>(HELP) CLR (HELP) CLR</p>	5.6
OP-9	Totally checks a program.	ACLR (-) OP 9 ENT READ	5.7
OP-10,11	Forcing the Relays ON/OFF. PROG. Mode: Y, R, L RUN Mode: X, Y, R, L, C and T	<p>ACLR (-) OP 1 0 ENT I•R NO. ENT 0</p> <p style="margin-left: 150px;">OFF</p> <p style="margin-left: 150px;">1</p> <p style="margin-left: 150px;">ON</p> <hr/> <p>Changing only relay number</p> <p>SRC ENT 0</p> <p style="margin-left: 150px;">OFF</p> <p>READ 1</p> <p style="margin-left: 150px;">ON</p> <hr/> <p>Changing relay name</p> <p>(HELP) CLR I•R NO. ENT 0</p> <p style="margin-left: 150px;">OFF</p> <p style="margin-left: 150px;">1</p> <p style="margin-left: 150px;">ON</p> <hr/> <p>Clear LCD</p> <p>(HELP) CLR (HELP) CLR</p>	5.8

OP Function Number	Description	Press:	Refer to:
OP-12	Monitors and changes double-word data (two register values) WX, WY, WR, WL, DT, FL and LD	Monitoring double-word data ACLR (-)OP 1 2 ENT I•R NO. READ ▼ (BIN) K/H SHIFT SC (BIN) K/H	5. 9 in decimal in hexadecimal in binary
		Changing double-word data (HELP) CLR (BIN) K/H NO. WRT (BIN) K/H NO. WRT	in decimal in hexadecimal
		Clear LCD (HELP) CLR (HELP) CLR	
OP-14	Changes the Program EDIT Mode; RUN EDIT Mode PROG. EDIT Mode Operate when editing a program in the RUN Mode.	ACLR (-)OP 1 4 ENT READ ▼ 0 WRT 1 WRT	5. 10 Monitoring PROG. EDIT Mode RUN EDIT Mode
		ACLR (-)OP 2 0 ENT READ ▼ NO. WRT READ ▼ (HELP) CLR NO. WRT	5. 11 Monitoring Setting Setting after monitoring
		Clear LCD (HELP) CLR (HELP) CLR	
OP-21	Specifies the Route number. Operate when you conduct the remote programming.	ACLR (-)OP 2 1 ENT READ ▼ NO. WRT READ ▼ (HELP) CLR NO. WRT	5. 12 Monitoring Setting Setting after monitoring
		Clear LCD (HELP) CLR (HELP) CLR	
		ACLR (-)OP 3 0 ENT READ ▼ 1 0 WRT 2 1 WRT	5. 13 Monitoring RUN Mode PROG. Mode

OP Function Number	Description	Press:	Refer to:
OP-50	Monitors/Sets System Register values	Monitoring system register values	5. 14
		<div style="display: flex; align-items: center; gap: 5px;"> ACLR (-) OP 5 0 ENT NO. READ </div>	in decimal
		<div style="display: flex; align-items: center; gap: 5px;"> (BIN) K/H </div>	in hexadecimal
		<div style="display: flex; align-items: center; gap: 5px;"> SHIFT SC (BIN) K/H </div>	in binary
		Changing system register values	
		<div style="display: flex; align-items: center; gap: 5px;"> (HELP) CLR (BIN) K/H NO. WRT </div>	in decimal
		<div style="display: flex; align-items: center; gap: 5px;"> (BIN) K/H NO. WRT </div>	in hexadecimal
		Clear LCD	
		<div style="display: flex; align-items: center; gap: 5px;"> (HELP) CLR (HELP) CLR </div>	
OP-51	Initializes System Registers	<div style="display: flex; align-items: center; gap: 5px;"> ACLR (-) OP 5 1 ENT WRT </div>	5. 15
OP-52	Allocates I/O Map	<div style="display: flex; align-items: center; gap: 5px;"> ACLR (-) OP 5 2 ENT WRT </div>	5. 16
OP-70	Selects the display language	<div style="display: flex; align-items: center; gap: 5px;"> ACLR (-) OP 7 0 ENT WRT 0 WRT </div>	English
		<div style="display: flex; align-items: center; gap: 5px;"> 1 </div>	Japanese
		<div style="display: flex; align-items: center; gap: 5px;"> 2 </div>	German
		<div style="display: flex; align-items: center; gap: 5px;"> 3 </div>	Italian
		<div style="display: flex; align-items: center; gap: 5px;"> 4 </div>	French
		<div style="display: flex; align-items: center; gap: 5px;"> 5 </div>	Spanish
OP-71	Adjusts the LCD Contrast	<div style="display: flex; align-items: center; gap: 5px;"> ACLR (-) OP 7 1 ENT WRT </div>	5. 18
OP-72	Set the programmable controller to the Registration Open/Close State (Password function)	<div style="display: flex; align-items: center; gap: 5px;"> ACLR (-) OP 7 2 0 WRT </div>	Close state
		<div style="display: flex; align-items: center; gap: 5px;"> 1 Pass word WRT </div>	Open state
OP-73	Registers/ Cancels the password	<div style="display: flex; align-items: center; gap: 5px;"> ACLR (-) OP 7 3 ENT ENT 0 Pass word WRT 0 </div>	Registration
		<div style="display: flex; align-items: center; gap: 5px;"> 1 </div>	Password reentry
		<div style="display: flex; align-items: center; gap: 5px;"> 1 WRT </div>	Cancellation
OP-74	Cancels the password forcibly.	<div style="display: flex; align-items: center; gap: 5px;"> ACLR (-) OP 7 4 ENT ENT 0 </div>	Cancellation
		<div style="display: flex; align-items: center; gap: 5px;"> 1 </div>	* Program is also cleared. Quitting cancellation

OP Function Number	Description	Press:	Refer to:
OP-90	Transfers a program from Memory Unit/ROM/IC memory card to internal RAM.		5. 22
OP-91	Transfers a program between the FP Programmer II and the programmable controller.	 	5. 23 Programmable controller to FP Programmer II FP Programmer II to programmable controller Program verification
OP-92	Transfers System Register settings between the FP Programmer II and the programmable controller.	 	5. 24 Programmable controller to FP Programmer II FP Programmer II to programmable controller Program verification
OP-99	Transfers a program from internal RAM to the Memory Unit/ROM/IC memory card.		5. 25
OP-110	Displays the self-diagnostic error codes.		5. 26
OP-111	Clears messages		5. 27
OP-112	Turn OFF the ERROR LED on the programmable controller (CPU).		5. 28

C-3 Key Operation for Entering the Instructions









The following tables shows which keys you should press to enter the instruction name and how the instruction name is displayed on the LCD. To enter each instruction, press the keys listed in the table from the left to the right in order. For example, to enter the ST/(start not) instruction, press the **ST** key and the **NOT** key in that order.

Note:

- Depending on the instructions you can use will vary. To know which instructions your programmable controller supports, refer to “Appendix A List of Instructions.”

Basic Instructions

Basic Sequence Instructions

Instructions	Keys to press	LCD display
ST Start		ST
ST/ Start not	 	ST /
OT Out		OT
/ Not		/
AN AND		AN
AN/ AND not	 	AN /
OR OR		OR
OR/ OR not	 	OR /
ANS AND stack	 	ANS
ORS OR stack	 	ORS
PSHS Push stack	  	PSHS
RDS Read stack	  	RDS
POPS Pop stack	  	POPS
KP Keep	  	KP
NOP Not operation	  	NOP
DF Leading edge differential	  	DF
DF/ Trailing edge differential	   	DF /
SET Set	   	SET
RST Reset	   	RST

Basic Function Instructions

Instructions		Keys to press	LCD display
TM	Timer		TM
F137(STMR)	Auxiliary timer	1	F137 STMR
CT	Counter		CT
F118(UDC)	UP/DOWN counter	1	F118 UDC
SR	Shift register(left shift)	3	SR
F119(LRSR)	Left/right shift register	1	F119 LRSR

Control Instructions

Instructions		Keys to press	LCD display
MC	Master control relay	4	MC
MCE	Master control relay end	5	MCE
JP	Jump	6	JP
F19(SJP)	Auxiliary jump	1	F 19 SJP
LBL	Label	7	LBL
LOOP	Loop	8	LOOP
BRK	Break	1	BRK
ED	End	1	ED
CNDE	Conditional end	1	CNDE
NSTP	Next step(pulse execution)	D	NSTP
NSTL	Next step(scan execution)	1	NSTL
SSTP	Start step	=	SSTP
CSTP	Clear step	<	CSTP
STPE	Step end	>	STPE
CALL	Subroutine call	1	CALL
SUB	Subroutine entry	1	SUB
RET	Return	1	RET

Instructions		Keys to press	LCD display
INT	Interrupt	SHIFT SC 1 6 SHIFT SC	INT
IRET	Interrupt return	SHIFT SC 1 7 SHIFT SC	IRET
ICTL	Interrupt control	SHIFT SC 1 5 SHIFT SC	ICTL









































































Data Comparison Instructions

Instructions		Keys to press	LCD display
ST =	word start equal	ST X*WX = C	ST =
AN =	word AND equal	AN Y*WY = C	AN =
OR =	word OR equal	OR R*WR = C	OR =
ST <>	word start equal not	ST X*WX < E > F	ST <>
AN <>	word AND equal not	AN Y*WY < E > F	AN <>
OR <>	word OR equal not	OR R*WR < E > F	OR <>
ST >	word start larger	ST X*WX > F	ST >
AN >	word AND larger	AN Y*WY > F	AN >
OR >	word OR larger	OR R*WR > F	OR >
ST >=	word start equal or larger	ST X*WX > F = C	ST >=
AN >=	word AND equal or larger	AN Y*WY > F = C	AN >=
OR >=	word OR equal or larger	OR R*WR > F = C	OR >=
ST <	word start smaller	ST X*WX < E	ST <
AN <	word AND smaller	AN Y*WY < E	AN <
OR <	word OR smaller	OR R*WR < E	OR <
ST <=	word start equal or smaller	ST X*WX < E = C	ST <=
AN <=	word AND equal or smaller	AN Y*WY < E = C	AN <=
OR <=	word OR equal or smaller	OR R*WR < E = C	OR <=

Instructions	Keys to press	LCD display
STD = double word start equal	$\begin{matrix} \text{ST} \\ \text{X}\cdot\text{WX} \end{matrix}$ $\begin{matrix} \text{D} \\ \text{D} \end{matrix}$ $\begin{matrix} = \\ \text{C} \end{matrix}$	STD =
AND = double word AND equal	$\begin{matrix} \text{AN} \\ \text{Y}\cdot\text{WY} \end{matrix}$ $\begin{matrix} \text{D} \\ \text{D} \end{matrix}$ $\begin{matrix} = \\ \text{C} \end{matrix}$	AND =
ORD = double word OR equal	$\begin{matrix} \text{OR} \\ \text{R}\cdot\text{WR} \end{matrix}$ $\begin{matrix} \text{D} \\ \text{D} \end{matrix}$ $\begin{matrix} = \\ \text{C} \end{matrix}$	ORD =
STD <> double word start equal not	$\begin{matrix} \text{ST} \\ \text{X}\cdot\text{WX} \end{matrix}$ $\begin{matrix} \text{D} \\ \text{D} \end{matrix}$ $\begin{matrix} < \\ \text{E} \end{matrix}$ $\begin{matrix} > \\ \text{F} \end{matrix}$	STD <>
AND <> double word AND equal not	$\begin{matrix} \text{AN} \\ \text{Y}\cdot\text{WY} \end{matrix}$ $\begin{matrix} \text{D} \\ \text{D} \end{matrix}$ $\begin{matrix} < \\ \text{E} \end{matrix}$ $\begin{matrix} > \\ \text{F} \end{matrix}$	AND <>
ORD <> double word OR equal not	$\begin{matrix} \text{OR} \\ \text{R}\cdot\text{WR} \end{matrix}$ $\begin{matrix} \text{D} \\ \text{D} \end{matrix}$ $\begin{matrix} < \\ \text{E} \end{matrix}$ $\begin{matrix} > \\ \text{F} \end{matrix}$	ORD <>
STD > double word start larger	$\begin{matrix} \text{ST} \\ \text{X}\cdot\text{WX} \end{matrix}$ $\begin{matrix} \text{D} \\ \text{D} \end{matrix}$ $\begin{matrix} > \\ \text{F} \end{matrix}$	STD >
AND > double word AND larger	$\begin{matrix} \text{AN} \\ \text{Y}\cdot\text{WY} \end{matrix}$ $\begin{matrix} \text{D} \\ \text{D} \end{matrix}$ $\begin{matrix} > \\ \text{F} \end{matrix}$	AND >
ORD > double word OR larger	$\begin{matrix} \text{OR} \\ \text{R}\cdot\text{WR} \end{matrix}$ $\begin{matrix} \text{D} \\ \text{D} \end{matrix}$ $\begin{matrix} > \\ \text{F} \end{matrix}$	ORD >
STD >= double word start equal or larger	$\begin{matrix} \text{ST} \\ \text{X}\cdot\text{WX} \end{matrix}$ $\begin{matrix} \text{D} \\ \text{D} \end{matrix}$ $\begin{matrix} > \\ \text{F} \end{matrix}$ $\begin{matrix} = \\ \text{C} \end{matrix}$	STD >=
AND >= double word AND equal or larger	$\begin{matrix} \text{AN} \\ \text{Y}\cdot\text{WY} \end{matrix}$ $\begin{matrix} \text{D} \\ \text{D} \end{matrix}$ $\begin{matrix} > \\ \text{F} \end{matrix}$ $\begin{matrix} = \\ \text{C} \end{matrix}$	AND >=
ORD >= double word OR equal or larger	$\begin{matrix} \text{OR} \\ \text{R}\cdot\text{WR} \end{matrix}$ $\begin{matrix} \text{D} \\ \text{D} \end{matrix}$ $\begin{matrix} > \\ \text{F} \end{matrix}$ $\begin{matrix} = \\ \text{C} \end{matrix}$	ORD >=
STD < double word start smaller	$\begin{matrix} \text{ST} \\ \text{X}\cdot\text{WX} \end{matrix}$ $\begin{matrix} \text{D} \\ \text{D} \end{matrix}$ $\begin{matrix} < \\ \text{E} \end{matrix}$	STD <
AND < double word AND smaller	$\begin{matrix} \text{AN} \\ \text{Y}\cdot\text{WY} \end{matrix}$ $\begin{matrix} \text{D} \\ \text{D} \end{matrix}$ $\begin{matrix} < \\ \text{E} \end{matrix}$	AND <
ORD < double word OR smaller	$\begin{matrix} \text{OR} \\ \text{R}\cdot\text{WR} \end{matrix}$ $\begin{matrix} \text{D} \\ \text{D} \end{matrix}$ $\begin{matrix} < \\ \text{E} \end{matrix}$	ORD <
STD <= double word start equal or smaller	$\begin{matrix} \text{ST} \\ \text{X}\cdot\text{WX} \end{matrix}$ $\begin{matrix} \text{D} \\ \text{D} \end{matrix}$ $\begin{matrix} < \\ \text{E} \end{matrix}$ $\begin{matrix} = \\ \text{C} \end{matrix}$	STD <=
AND <= double word AND equal or smaller	$\begin{matrix} \text{AN} \\ \text{Y}\cdot\text{WY} \end{matrix}$ $\begin{matrix} \text{D} \\ \text{D} \end{matrix}$ $\begin{matrix} < \\ \text{E} \end{matrix}$ $\begin{matrix} = \\ \text{C} \end{matrix}$	AND <=
ORD <= double word OR equal or smaller	$\begin{matrix} \text{OR} \\ \text{R}\cdot\text{WR} \end{matrix}$ $\begin{matrix} \text{D} \\ \text{D} \end{matrix}$ $\begin{matrix} < \\ \text{E} \end{matrix}$ $\begin{matrix} = \\ \text{C} \end{matrix}$	ORD <=

High Level Instructions

Data Transfer Instructions

Instructions	Keys to press	LCD display
F0(MV) 16-bit data Move	 	F 0 MV
P0(PMV)	  	P 0 PMV
F1(DMV) 32-bit data Move	 	F 1 DMV
P1(PDMV)	  	P 1 PDMV
F2(MV/) 16-bit data Invert and move	 	F 2 MV/
P2(PMV/)	  	P 2 PMV/
F3(DMV/) 32-bit data Invert and move	 	F 3 DMV/
P3(PDMV/)	  	P 3 PDMV/
F5(BTM) Bit data Move	 	F 5 BTM
P5(PBTM)	  	P 5 PBTM
F6(DGT) Hexadecimal digit Move	 	F 6 DGT
P6(PDGT)	  	P 6 PDGT
F10(BKMV) Block Move	  	F 10 BKMV
P10(PBKMV)	   	P 10 PBKMV
F11(COPY) Block Copy	  	F 11 COPY
P11(PCOPY)	   	P 11 PCOPY
F12(ICRD) Data Read from IC Memory Card	  	F 12 ICRD
P12(PICRD)	   	P 12 PICRD
F13(ICWT) Data Write to IC Memory Card	  	F 13 ICWT
P13(PICWT)	   	P 13 PICWT
F14(PGRD) Program Read from IC Memory Card	  	F 14 PGRD
P14(PPGRD)	   	P 14 PPGRD
F15(XCH) 16-bit data Exchange	  	F 15 XCH
P15(PXCH)	   	P 15 PXCH

Instructions	Keys to press	LCD display
F16(DXCH) 32-bit data Exchange		F 16 DXCH
P16(PDXCH)		P 16 PDXCH
F17(SWAP) High/low bytes Exchange		F 17 SWAP
P17(PSWAP)		P 17 PSWAP

BIN Arithmetic Instructions

Instructions	Keys to press	LCD display
F20(+) 16-bit data [D+S→D]		F 20 +
P20(P+)		P 20 P+
F21(D+) 32-bit data [(D+1,D)+(S+1,S)→(D+1,D)]		F 21 D+
P21(PD+)		P 21 PD+
F22(+) 16-bit data [S1+S2→D]		F 22 +
P22(P+)		P 22 P+
F23(D+) 32-bit data [(S1+1,S1)+(S2+1,S2)→(D+1,D)]		F 23 D+
P23(PD+)		P 23 PD+
F25(-) 16-bit data [D-S→D]		F 25 -
P25(P-)		P 25 P-
F26(D-) 32-bit data [(D+1,D)-(S+1,S)→(D+1,D)]		F 26 D-
P26(PD-)		P 26 PD-
F27(-) 16-bit data [S1-S2→D]		F 27 -
P27(P-)		P 27 P-
F28(D-) 32-bit data [(S1+1,S1)-(S2+1,S2)→(D+1,D)]		F 28 D-
P28(PD-)		P 28 PD-
F30(*) 16-bit data [S1×S2→(D+1,D)]		F 30 *
P30(P*)		P 30 P*



































Instructions		Keys to press	LCD display
F31(D*)	32-bit data [(S1+1,S1)×(S2+1,S2)→ (D+3,D+2,D+1,D)]	$\begin{matrix} \text{FN/P} \\ \text{FL} \end{matrix}$ 3 1	F 31 D*
P31(PD*)		$\begin{matrix} \text{FN/P} \\ \text{FL} \end{matrix}$ $\begin{matrix} \text{FN/P} \\ \text{FL} \end{matrix}$ 3 1	P 31 PD*
F32(%)	16-bit data [S1/S2→D...(DT9015)]	$\begin{matrix} \text{FN/P} \\ \text{FL} \end{matrix}$ 3 2	F 32 %
P32(P%)		$\begin{matrix} \text{FN/P} \\ \text{FL} \end{matrix}$ $\begin{matrix} \text{FN/P} \\ \text{FL} \end{matrix}$ 3 2	P 32 P%
F33(D%)	32-bit data [(S1+1,S1)/(S2+1,S2)→ (D+1,D)...(DT9016,DT9015)]	$\begin{matrix} \text{FN/P} \\ \text{FL} \end{matrix}$ 3 3	F 33 D%
P33(PD%)		$\begin{matrix} \text{FN/P} \\ \text{FL} \end{matrix}$ $\begin{matrix} \text{FN/P} \\ \text{FL} \end{matrix}$ 3 3	P 33 PD%
F35(+1)	16-bit data increment [D+1→D]	$\begin{matrix} \text{FN/P} \\ \text{FL} \end{matrix}$ 3 5	F 35 +1
P35(P+1)		$\begin{matrix} \text{FN/P} \\ \text{FL} \end{matrix}$ $\begin{matrix} \text{FN/P} \\ \text{FL} \end{matrix}$ 3 5	P 35 P+1
F36(D+1)	32-bit data increment [(D+1,D)+1→(D+1,D)]	$\begin{matrix} \text{FN/P} \\ \text{FL} \end{matrix}$ 3 6	F 36 D+1
P36(PD+1)		$\begin{matrix} \text{FN/P} \\ \text{FL} \end{matrix}$ $\begin{matrix} \text{FN/P} \\ \text{FL} \end{matrix}$ 3 6	P 36 PD+1
F37(-1)	16-bit data decrement [D-1→D]	$\begin{matrix} \text{FN/P} \\ \text{FL} \end{matrix}$ 3 7	F 37 -1
P37(P-1)		$\begin{matrix} \text{FN/P} \\ \text{FL} \end{matrix}$ $\begin{matrix} \text{FN/P} \\ \text{FL} \end{matrix}$ 3 7	P 37 P-1
F38(D-1)	32-bit data decrement [(D+1,D)-1→(D+1,D)]	$\begin{matrix} \text{FN/P} \\ \text{FL} \end{matrix}$ 3 8	F 38 D-1
P38(PD-1)		$\begin{matrix} \text{FN/P} \\ \text{FL} \end{matrix}$ $\begin{matrix} \text{FN/P} \\ \text{FL} \end{matrix}$ 3 8	P 38 PD-1
F160(DSQR)	32-bit data square root [(S+1,S)→(D+1,D)]	$\begin{matrix} \text{FN/P} \\ \text{FL} \end{matrix}$ 1 6 0	F160 DSQR
P160(PDSQR)		$\begin{matrix} \text{FN/P} \\ \text{FL} \end{matrix}$ $\begin{matrix} \text{FN/P} \\ \text{FL} \end{matrix}$ 1 6 0	P160 PDSQR

BCD Arithmetic Instructions





























Instructions		Keys to press	LCD display
F40(B+)	4-digit BCD [D+S→D]	$\begin{matrix} \text{FN/P} \\ \text{FL} \end{matrix}$ 4 0	F 40 B+
P40(PB+)		$\begin{matrix} \text{FN/P} \\ \text{FL} \end{matrix}$ $\begin{matrix} \text{FN/P} \\ \text{FL} \end{matrix}$ 4 0	P 40 PB+
F41(DB+)	8-digit BCD [(D+1,D)+(S+1,S)→(D+1,D)]	$\begin{matrix} \text{FN/P} \\ \text{FL} \end{matrix}$ 4 1	F 41 DB+
P41(PDB+)		$\begin{matrix} \text{FN/P} \\ \text{FL} \end{matrix}$ $\begin{matrix} \text{FN/P} \\ \text{FL} \end{matrix}$ 4 1	P 41 PDB+
F42(B+)	4-digit BCD [S1+S2→D]	$\begin{matrix} \text{FN/P} \\ \text{FL} \end{matrix}$ 4 2	F 42 B+
P42(PB+)		$\begin{matrix} \text{FN/P} \\ \text{FL} \end{matrix}$ $\begin{matrix} \text{FN/P} \\ \text{FL} \end{matrix}$ 4 2	P 42 PB+
F43(DB+)	8-digit BCD [(S1+1,S1)+(S2+1,S2)→(D+1,D)]	$\begin{matrix} \text{FN/P} \\ \text{FL} \end{matrix}$ 4 3	F 43 DB+
P43(PDB+)		$\begin{matrix} \text{FN/P} \\ \text{FL} \end{matrix}$ $\begin{matrix} \text{FN/P} \\ \text{FL} \end{matrix}$ 4 3	P 43 PDB+

Instructions		Keys to press			LCD display
F45(B-)	4-digit BCD [D-S→D]				F 45 B-
P45(PB-)				 	P 45 PB-
F46(DB-)	8-digit BCD [(D+1,D)-(S+1,S)→(D+1,D)]				F 46 DB-
P46(PDB-)				 	P 46 PDB-
F47(B-)	4-digit BCD [S1-S2→D]				F 47 B-
P47(PB-)				 	P 47 PB-
F48(DB-)	8-digit BCD [(S1+1,S1)-(S2+1,S2)→(D+1,D)]				F 48 DB-
P48(PDB-)				 	P 48 PDB-
F50(B*)	4-digit BCD [S1×S2→(D+1,D)]				F 50 B*
P50(PB*)				 	P 50 PB*
F51(DB*)	8-digit BCD [(S1+1,S1)×(S2+1,S2)→ (D+3,D+2,D+1,D)]				F 51 DB*
P51(PDB*)				 	P 51 PDB*
F52(B%)	4-digit BCD [S1/S2→D...(DT9015)]				F 52 B%
P52(PB%)				 	P 52 PB%
F53(DB%)	8-digit BCD [(S1+1,S1)/(S2+1,S2)→ (D+1,D)...(DT9016,DT9015)]				F 53 DB%
P53(PDB%)				 	P 53 PDB%
F55(B+1)	4-digit BCD increment [D+1→D]				F 55 B+1
P55(PB+1)				 	P 55 PB+1
F56(DB+1)	8-digit BCD increment [(D+1,D)+1→(D+1,D)]				F 56 DB+1
P56(PDB+1)				 	P 56 PDB+1
F57(B-1)	4-digit BCD decrement [D-1→D]				F 57 B-1
P57(PB-1)				 	P 57 PB-1
F58(DB-1)	8-digit BCD decrement [(D+1,D)-1→(D+1,D)]				F 58 DB-1
P58(PDB-1)				 	P 58 PDB-1



















































































Data Comparison Instructions



























































































Instructions	Keys to press	LCD display
F60(CMP) 16-bit data Compare	  	F 60 CMP
P60(PCMP)	   	P 60 PCMP
F61(DCMP) 32-bit data Compare	  	F 61 DCMP
P61(PDCMP)	   	P 61 PDCMP
F62(WIN) 16-bit data range Compare	  	F 62 WIN
P62(PWIN)	   	P 62 PWIN
F63(DWIN) 32-bit data range Compare	  	F 63 DWIN
P63(PDWIN)	   	P 63 PDWIN
F64(BCMP) Same block Detect	  	F 64 BCMP
P64(PBCMP)	   	P 64 PBCMP

Logic Operation Instructions

Instructions	Keys to press	LCD display
F65(WAN) 16-bit data AND	  	F 65 WAN
P65(PWAN)	   	P 65 PWAN
F66(WOR) 16-bit data OR	  	F 66 WOR
P66(PWOR)	   	P 66 PWOR
F67(XOR) 16-bit data Exclusive OR	  	F 67 XOR
P67(PXOR)	   	P 67 PXOR
F68(XNR) 16-bit data Exclusive NOR	  	F 68 XNR
P68(PXNR)	   	P 68 PXNR

Data Conversion Instructions

Instructions	Keys to press	LCD display
F70(BCC) — Block check code calculation	  	F 70 BCC
P70(PBCC)	   	P 70 PBCC
F71(HEXA) — HEX to HEX ASCII conversion	  	F 71 HEXA
P71(PHEXA)	   	P 71 PHEXA
F72(AHEX) — HEX ASCII to HEX conversion	  	F 72 AHEX
P72(PAHEX)	   	P 72 PAHEX
F73(BCDA) — BCD to DEC ASCII conversion	  	F 73 BCDA
P73(PBCDA)	   	P 73 PBCDA
F74(ABCD) — DEC ASCII to BCD conversion	  	F 74 ABCD
P74(PABCD)	   	P 74 PABCD
F75(BINA) — BIN to DEC ASCII conversion	  	F 75 BINA
P75(PBINA)	   	P 75 PBINA
F76(ABIN) — DEC ASCII to BIN conversion	  	F 76 ABIN
P76(PABIN)	   	P 76 PABIN
F77(DBIA) — BIN to DEC ASCII conversion	  	F 77 DBIA
P77(PDBIA)	   	P 77 PDBIA
F78(DABI) — DEC ASCII to BIN conversion	  	F 78 DABI
P78(PDABI)	   	P 78 PDABI
F80(BCD) — 16-bit data → 4-digit BCD	  	F 80 BCD
P80(PBCD)	   	P 80 PBCD
F81(BIN) — 4-digit BCD → 16-bit data	  	F 81 BIN
P81(PBIN)	   	P 81 PBIN
F82(DBCD) — 32-bit data → 8-digit BCD	  	F 82 DBCD
P82(PDBCD)	   	P 82 PDBCD



























Instructions	Keys to press	LCD display
F83(DBIN) — 8-digit BCD → 32-bit data	  	F 83 DBIN
P83(PDBIN)	   	P 83 PDBIN
F84(INV) — 16-bit data Invert	  	F 84 INV
P84(PINV)	   	P 84 PINV
F85(NEG) — 16-bit data Two's complement	  	F 85 NEG
P85(PNEG)	   	P 85 PNEG
F86(DNEG) — 32-bit data Two's complement	  	F 86 DNEG
P86(PDNEG)	   	P 86 PDNEG
F87(ABS) — 16-bit data Absolute	  	F 87 ABS
P87(PABS)	   	P 87 PABS
F88(DABS) — 32-bit data Absolute	  	F 88 DABS
P88(PDABS)	   	P 88 PDABS
F89(EXT) — 16-bit Sign extension	  	F 89 EXT
P89(PEXT)	   	P 89 PEXT
F90(DECO) — Decode	  	F 90 DECO
P90(PDECO)	   	P 90 PDECO
F91(SEGT) — 16-bit data 7-segment decode	  	F 91 SEGT
P91(PSEGT)	   	P 91 PSEGT
F92(ENCO) — Encode	  	F 92 ENCO
P92(PENCO)	   	P 92 PENCO
F93(UNIT) — 16-bit data Combine	  	F 93 UNIT
P93(PUNIT)	   	P 93 PUNIT
F94(DIST) — 16-bit data Distribute	  	F 94 DIST
P94(PDIST)	   	P 94 PDIST
F95(ASC) — Character → ASCII code	  	F 95 ASC
P95(PASC)	   	P 95 PASC

Instructions	Keys to press	LCD display
F96(SRC) Table data Search		F 96 SRC
P96(PSRC)		P 96 PSRC
F98(CMPR) Word data Comparison		F 98 CMPR
P98(PCMPR)		P 98 PCMPR
F99(CMPW) Double word data Comparison		F 99 CMPW
P99(PCMPW)		P 99 PCMPW





































Data Shift Instructions

Instructions	Keys to press	LCD display
F100(SHR) 16-bit data Right shift		F100 SHR
P100(PSHR)		P100 PSHR
F101(SHL) 16-bit data Left shift		F101 SHL
P101(PSHL)		P101 PSHL
F105(BSR) 16-bit data 1-digit right shift		F105 BSR
P105(PBSR)		P105 PBSR
F106(BSL) 16-bit data 1-digit left shift		F106 BSL
P106(PBSL)		P106 PBSL
F110(WSHR) Block 1-word right shift		F110 WSHR
P110(PWSHR)		P110 PWSHR
F111(WSHL) Block 1-word left shift		F111 WSHL
P111(PWSHL)		P111 PWSHL
F112(WBSR) Block 1-digit right shift		F112 WBSR
P112(PWBSR)		P112 PWBSR
F113(WBSL) Block 1-digit left shift		F113 WBSL
P113(PWBSL)		P113 PWBSL























































FIFO(First-In-First-Out) Instructions

Instructions	Keys to press	LCD display
F115(FIFT) — FIFO buffer Define	   	F115 FIFT
P115(PFIFT)	    	P115 PFIFT
F116(FIFR) — Data read from FIFO buffer	   	F116 FIFR
P116(PFIFR)	    	P116 PFIFR
F117(FIFW) — Data write into FIFO buffer	   	F117 FIFW
P117(PFIFW)	    	P117 PFIFW













































Data Rotate Instructions

Instructions	Keys to press	LCD display
F120(ROR) — 16-bit data Right rotate	   	F120 ROR
P120(PROR)	    	P120 PROR
F121(ROL) — 16-bit data Left rotate	   	F121 ROL
P121(PROL)	    	P121 PROL
F122(RCR) — 16-bit data Right rotate with carry flag	   	F122 RCR
P122(PRCR)	    	P122 PRCR
F123(RCL) — 16-bit data Left rotate with carry flag	   	F123 RCL
P123(PRCL)	    	P123 PRCL











































BIT Manipulation Instructions

Instructions	Keys to press	LCD display
F130(BTS) 16-bit data Bit set	   	F130 BTS
P130(PBTS)	    	P130 PBTS
F131(BTR) 16-bit data Bit reset	   	F131 BTR
P131(PBTR)	    	P131 PBTR
F132(BTI) 16-bit data Bit invert	   	F132 BTI
P132(PBTI)	    	P132 PBTI
F133(BTT) 16-bit data Bit test	   	F133 BTT
P133(PBTT)	    	P133 PBTT
F135(BCU) 16-bit data Total 1's number	   	F135 BCU
P135(PBCU)	    	P135 PBCU
F136(DBCU) 32-bit data Total 1's number	   	F136 DBCU
P136(PDBCUC)	    	P136 PDBCUC

Special Instructions

Instructions	Keys to press	LCD display
F138(HMSS) Hours/minutes/seconds data to second data conversion	   	F138 HMSS
P138(PHMSS)	    	P138 PHMSS
F139(SHMS) Seconds to hours/nimutes/seconds data conversion	   	F139 SHMS
P139(PSHMS)	    	P139 PSHMS
F140(STC) Carry flag (R9009)	   	F139 STC
P140(PSTC)	    	P140 PSTC
F141(CTC) Carry flag (R9009) Reset	   	F141 CTC
P141(PCTC)	    	P141 PCTC
F142(WDT) Watchdog timer Update (only for FP5)	   	F142 WDT
P142(PWDT)	    	P142 PWDT

Instructions	Keys to press	LCD display
F143(IORF) — Partial I/O Update		F143 IORF
P143(PIORF)		P143 PIORF
P144(TRNS) — Transmission to serial port		P144 TRNS
F145(SEND) — Link data Send		F145 SEND
P145(PSEND)		P145 PSEND
F146(RECV) — Link data Receive		F146 RECV
P146(PRECV)		P146 PRECV
P147(PR) — Print out		P147 PR
F148(ERR) — Self-diagnostic error Set		F148 ERR
P148(PERR)		P148 PERR
F149(MSG) — Message display		F149 MSG
P149(PMSG)		P149 PMSG
F150(READ) — Data read from advanced units		F150 READ
P150(PREAD)		P150 PREAD
F151(WRT) — Data write into advanced units		F151 WRT
P151(PWRT)		P151 PWRT
F152(RMRD) — Data read from the slave station		F152 RMRD
P152(PRMRD)		P152 PRMRD
F153(RMWT) — Data write into the slave station		F153 RMWT
P153(PRMWT)		P153 PRMWT
F154(MCAL) — Machine language call		F154 MCAL
P154(PMCAL)		P154 PMCAL
F155(SMPL) — Sampling Start		F155 SMPL
P155(PSMPL)		P155 PSMPL

Instructions	Keys to press	LCD display
F156(STRG) Sampling Stop	   	F156 STRG
P156(PSTRG)	    	P156 PSTRG
F157(CADD) Time Add	   	F157 CADD
P157(PCADD)	    	P157 PCADD
F158(CSUB) Time Subtract	   	F158 CSUB
P158(PCSUB)	    	P158 PCSUB
P162(HC0S) ON when the target value agrees	   	P162 HC0S
P163(HC0R) OFF when the target value agrees	   	P163 HC0R
P164(SPD0) Speed control instruction	   	P164 SPD0
P165(CAM0) Cam control	   	P165 CAM0

Appendix D General Specifications

Current Consumption	130 mA max.
Vibration resistance	10 to 55 Hz 0.75 mm on 3 axes, 20 min for each
Shock resistance	10G on 3 axes, four times each
Ambient temperature	0 °C to 50 °C (0 °F to 130 °F)
Ambient humidity	30% to 85% RH (no dew-condensing)
Storage temperature	-20 °C to 60 °C (-52 °F to 156 °F)
Weight	Approx. 230 g
Backup battery	Electrical double layer capacitor

Appendix E Conversion Cable

The “conversion cable” is used when you connect the FP Programmer II with the personal computer(IBM PC/AT or the 100% compatible).

Make the conversion cable, as referring to the following wiring diagram:

To the FP Programmer II computer cable

To the personal computer

D-sub female 25-pin connector

D-sub male 9-pin connector

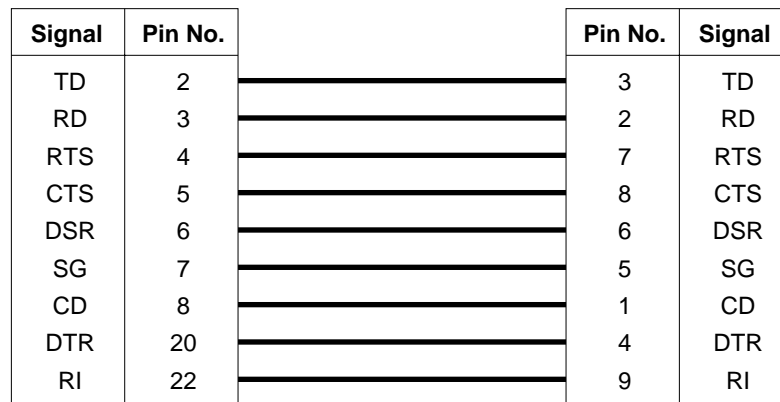

Appendix F Cross Cable

The cable which connects the FP Programmer II and the modem must be the straight cable. But the FP Programmer II computer cable(Part No.1551) which connects the FP Programmer II and the personal computer is the cross cable. So, by connecting another cross cable to the FP Programmer II computer cable, make the connection between these devices the straight cable connection.

Make the cross cable, as referring to the following wiring diagram:

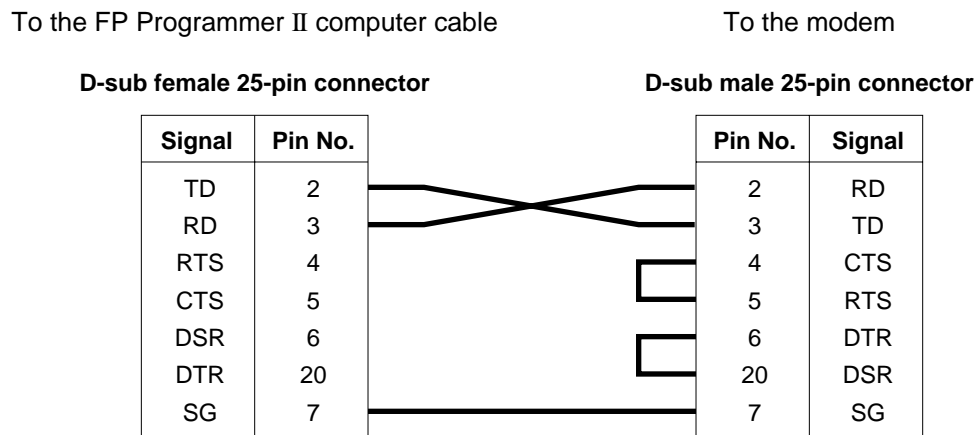

Appendix G FP Programmer II Coding Sheet

Make a copy and use the sheet for your convenient.

Machine Number: _____ Date: _____

Program Name: _____ Page: _____

Customer: _____

Address	Instruction	Remarks	Address	Instruction	Remarks
0			0		
1			1		
2			2		
3			3		
4			4		
5			5		
6			6		
7			7		
8			8		
9			9		
0			0		
1			1		
2			2		
3			3		
4			4		
5			5		
6			6		
7			7		
8			8		
9			9		
0			0		
1			1		
2			2		
3			3		
4			4		
5			5		
6			6		
7			7		
8			8		
9			9		

Approved by: _____ Checked by: _____ Created by: _____

Appendix I Differences between the FP Programmer Series

The following table shows the differences of abilities between the FP Programmers (Part No1112 and AFP1112A) and the FP Programmer II (Part No. AFP1114).

Item	AFP1112	AFP1112A	AFP1114
Programmable controller supported	FP1 FP3 FP5	FP1 FP3 FP5	FP1 FP3 FP5 FP10S FP10 FP-M FP-C
Communication Parameters	Baud rate: 19,200 bps Data bits: 8 bits Parity: Odd Stop bit: 1 bit Set the communication parameters of programmable controller as shown above.	The FP Programmer (AFP1112A) will automatically set its communication parameters to fit those of programmable controller with which the FP Programmer is connected. You do not have to set the parameters for communication between the FP Programmer and programmable controller. For more information, refer to "1.5 Setting-up the FP Programmer II."	The FP Programmer II (AFP1114) will automatically set its communication parameters to fit those of programmable controller with which the FP Programmer II is connected. You do not have to set the parameters for communication between the FP Programmer II and programmable controller. For more information, refer to "1.5 Setting-up the FP Programmer II."
Instructions			
Comparison instructions ("ST=", etc.)	Cannot be read/written from/to the programmable controller.	Cannot be read/written from/to the programmable controller.	Can be read/written from/to the programmable controller. Be sure to check the version of programmable controller (CPU).
NSTL	Cannot be read/written from/to the programmable controller.	Can be read/written on the FP3 whose suffix is C Can be read/written on the FP1 whose suffix is A or B	Can be read/written on the FP3 whose suffix is C Can be read/written on the FP1 whose suffix is A or B
F64(BCMP) F98(CMPR) F99(CMPW) F157(CADD) F158(CSUB)	Cannot be written to the programmable controller. However, you can read them from the programmable controller.	Can be read/written on the FP3 whose suffix is C Can be read/written on the FP1 whose suffix is A or B (F98 and F99 instructions are only for FP3.)	Can be read/written on the FP3 whose suffix is C Can be read/written on the FP1 whose suffix is A or B (F98 and F99 instructions are only for FP3.)
F12(BCMP) F13(ICWT) f14(RGRD)	Cannot be read/written from/to the programmable controller.	Cannot be read/written from/to the programmable controller.	Can be read/written from/to only the FP10 and FP10S. For other type of programmable controllers, these instructions cannot be used.

Item	AFP1112	AFP1112A	AFP1114
OP Functions			
OP-21	You can select the route number only from 1 to 3. The AFP1112 does not support the MEWNET-H Link System, so you cannot specify the route number from No.4 to No.6.	You can specify the route number from 1 to 6. MEWNET-H Link System is supported on the FP1112A FP Programmer.	You can specify the route number from 1 to 6. MEWNET-H Link System is supported on the FP1114 FP Programmer II.
OP-72	Cannot be operated. You cannot set the programmable controller to the “registration open state” or the “registration close state” for the password using the AFP1112 FP Programmer.	Can be operated. You can set the programmable controller to the “registration open state” or the “registration close state” for the password using the AFP1112A FP Programmer.	Can be operated. You can set the programmable controller to the “registration open state” or the “registration close state” for the password using the FP Programmer II.
OP-73	Cannot be operated. You cannot register the password to the programmable controller nor cancel it with the FP Programmer.	Can be operated. You can register the password to the programmable controller and also cancel it by operating the OP-73.	Can be operated. You can register the password to the programmable controller and also cancel it by operating the OP-73.
OP-74	Cannot be operated. Once you forget the password, you cannot cancel the password with the AFP1112 FP Programmer.	Can be operated. You can cancel the password forcedly by operating the OP 74. Note that operating the OP-74 will clear the program stored on the programmable controller.	Can be operated. You can cancel the password forcedly by operating the OP 74. Note that operating the OP-74 will clear the program stored on the programmable controller.
OP-99	The error message “BCC ERR(BCC error)” may be displayed when you transfer more than 11 kilo steps of program, even if your programmable controller is the FP3, FP-C or FP-M with the EEP-ROM or the FP1 with the master memory unit. The transfer will complete successfully.	The error message “BCC ERR” may not appear even if you transfer more than 11 kilo steps of program. The OP-99 operation will complete successfully if your programmable controller is the FP3 with the EEP-ROM or the FP1 with the master memory unit.	The error message “BCC ERR” may not appear even if you transfer more than 11 kilo steps of program. The OP-99 operation will complete successfully if your programmable controller is the FP3, FP-C or FP-M with the EEP-ROM or the FP1 with the master memory unit
Program carrier function	You cannot carry the program between the NPST-GR and the programmable controller with the AFP1112 FP Programmer.	You cannot carry the program between the NPST-GR and the programmable controller with the AFP1112A FP Programmer II.	You can carry the program between the NPST-GR and the programmable controller with the FP programmer II.

INDEX

A

- Adjust
 - LCD contrast82
- Allocate
 - I/O number80
- Alphanumeric keys5

B

- Basic instruction code.....32
- Beep4

C

- Cancel
 - password85, 86
- Carry
 - program96
- Change
 - basic instruction38
 - double-word data69
 - high level instruction.....41
 - edit mode of programmable controller ..70
 - mode of programmable controller75
 - system register value.....78
 - word data.....59
- Check
 - program62
- Clear
 - hold area.....55
 - message92
 - program area55
- Connector.....3
- Conversion cable161
- Cross cable.....162

D

- Delete
 - instruction with shifting address46
 - instruction without shifting address48
 - NOP instructions.....56
- Display language81
- Display
 - self-diagnostic error91
- Double-word data66

E

- Enter
 - basic instruction26
 - high level instruction.....35
- Enter to
 - registration close state.....83
 - registration open state83
- ERROR LED93
- Error message106

F

- Forced I/O operation.....63
- FP peripheral cable8
- FP Programmer cable M5 type8
- FP1 peripheral cable8

I

- I/O map80
- I/O number80
- Initialize
 - system register79
- Insert
 - instruction44

L

LCD	3
LCD Contrast.....	82
Link Unit number	72

M

Monitor	
double-word data	67
relay.....	60
system register	77
word data.....	57

O

OP Functions	52
Operation keys.....	3, 4
OP-0.....	55
OP-1.....	56
OP-2.....	57
OP-3.....	57
OP-7.....	60
OP-8.....	57
OP-9.....	62
OP-10.....	63
OP-11.....	63
OP-12.....	66
OP-14.....	70
OP-20.....	72
OP-21.....	74
OP-30.....	75
OP-31.....	75
OP-32.....	75
OP-50.....	77
OP-51.....	79
OP-52.....	80

OP-70.....	81
OP-71.....	82
OP-72.....	83
OP-73.....	84
OP-74.....	86
OP-90.....	87
OP-91.....	88
OP-92.....	89
OP-99.....	90
OP-110.....	91
OP-111.....	92
OP-112.....	96

P

Password.....	83, 84, 86
PLC EDIT MODE	70
PLC MODE	75
PROG EDIT MODE.....	70

R

Read	
instruction	10
Register.....	18, 57, 66
Register	
password	84
Registration close state	83
Registration open state.....	83
Relay	16, 60, 63
Relay/Instruction keys	5
Remote I/O map.....	80
Remote programming	100
Route number	74
RUN EDIT mode.....	70

S

Search	
instruction	20
register.....	18
relay.....	16
Select	
basic instruction code.....	32
display language.....	81
OP Function	53
Self-diagnostic error	91
Set-up	
FP Programmer II.....	7
Specify	
Link Unit number.....	72
route number	74
System register	77

T

Transfer	
program	
(FP Programmer II - NPST-GR)	97
program	
(FP Programmer II - PLC).....	88, 97
program (FP Programmer II -	
remote NPST-GR).....	100
program (RAM to ROM)	90
program (ROM to RAM)	87
system register values	
(FP Programmer II - PLC)	89
Turn off	
ERROR LED	93
Turn	
on/off relay	63

W

Word data	57
-----------------	----