

Altivar 32 variable speed drives

For 3-phase motors from 0.18 to 15 kW/0.25 to 20 HP

Catalog

April **2015**



How can you fit a 6000-page catalog in your pocket ?

Schneider Electric provides you with the complete set of industrial automation catalogs all on a handy USB key for PC or in an application for tablets



Digi-Cat, a handy USB key for PC



- > Convenient to carry
- > Always up-to-date
- > Environmentally friendly
- > Easy-to-share format

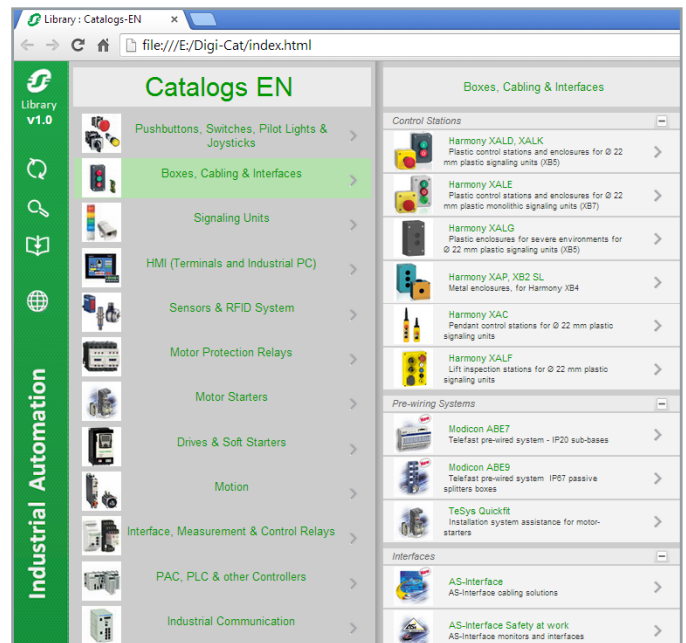

Contact your local representative to get your own Digi-Cat



e-Library, the app for tablets

If you have an iPad®:

- > Go to the App Store and search for e-Library
- > or scan the QR code



If you have an Android tablet:

- > Go to the Google Play Store™ and search for eLibrary
- > or scan the QR code



General contents

Altivar 32 variable speed drives

Offer for complex machines page 2

■ **Variable speed drives** page 4

□ Presentation page 4

□ References page 10

■ **Options** page 11

□ Variants, accessories page 11

□ Dialog tools, configuration tools page 12

□ Braking resistors page 15

□ Line chokes page 16

□ Motor chokes page 17

□ Integrated EMC filters and additional EMC input filters page 18

□ Speed monitoring card page 19

□ Communication buses and networks page 20

■ **Motor starters** page 26

■ **Product reference index** page 30

Altivar 32 variable speed drives and Lexium 32 motion control

Application areas	General Specific
Technology type	

Printing, material handling, conveying, transfer machines, packaging, textiles, etc. Hoisting, wood-working or metal processing machines, etc.
Altivar 32 variable speed drives without sensor (velocity control)



Power range for 50...60 Hz (kW) line supply	
Single-phase 100...120 V (kW)	0.18...15 kW/0.25...20 HP
Single-phase 200...240 V (kW)	–
Three-phase 208...480 V (kW)	0.18...2.2 kW/0.25...3 HP
Three-phase 380...500 V (kW)	–

0.18...15 kW/0.25...20 HP	–
0.18...2.2 kW/0.25...3 HP	–
0.37...15 kW/0.5...20 HP	–

Drive	Motor speed	0.1...599 Hz
	Type of control	Asynchronous motor
		Synchronous motor
	Motor sensor	Integrated Available as an option
	Transient overtorque	170...200% of the nominal motor torque
	Peak current	–

0.1...599 Hz	Voltage/frequency ratios: U/f and 5-point U/f Sensorless flux vector control ratio Kn ² quadratic ratio (pump/fan) Energy saving ratio
–	Ratio for synchronous motor without sensor
–	–
170...200% of the nominal motor torque	–

Number of functions	150
Safety functions	Integrated Available as an option

150	4: STO (Safe Torque Off), SLS (Safe Limited Speed), SDI (Safe Direction Information), SS1 (Safe Stop 1)
–	–

Number of I/O	Inputs	Analog Logic	3 6
	Outputs	Analog Logic	1: configurable as voltage (0-10 V) or current (0-20 mA) 1
	Relay outputs		2

3	6
1: configurable as voltage (0-10 V) or current (0-20 mA)	1
2	–

Communication	Integrated Available as an option Bluetooth link®
---------------	---

Modbus, CANopen	DeviceNet, PROFIBUS DP V1, EtherNet/IP, Modbus TCP, EtherCat, ProfiNet, POWERLINK
–	Available with ATV32H●●●●437 references

Options	SoMove setup software Simple Loader and Multi-Loader configuration tools IP 54 or IP 65 remote display terminal and remote graphic display terminal Filters, braking resistors, line chokes, speed monitoring card
---------	---

SoMove setup software Simple Loader and Multi-Loader configuration tools IP 54 or IP 65 remote display terminal and remote graphic display terminal Filters, braking resistors, line chokes, speed monitoring card

Standards and certifications	IEC 61800-5-1, IEC 61800-3 (environments 1 and 2, category C2), UL 508C, EN 954-1 category 3, ISO/EN 13849-1/- 2 category 3 (PL e), IEC 61508 (parts 1 & 2) SIL 3 level, draft standard EN 50495E, IEC 60721-3-3, classes 3C3 and 3S2 CE, UL, CSA, C-Tick, NOM, GOST
------------------------------	---

IEC 61800-5-1, IEC 61800-3 (environments 1 and 2, category C2), UL 508C, EN 954-1 category 3, ISO/EN 13849-1/- 2 category 3 (PL e), IEC 61508 (parts 1 & 2) SIL 3 level, draft standard EN 50495E, IEC 60721-3-3, classes 3C3 and 3S2 CE, UL, CSA, C-Tick, NOM, GOST

References	ATV 32
Pages	10

ATV 32
10

Printing, material handling, conveying, transfer machines, packaging, textiles, etc. Clamping, cutting, cutting to length, flying shear, rotary knife, Pick & Place, winding, marking, etc.
Lexium 32 servo drives with sensor feedback (position control)

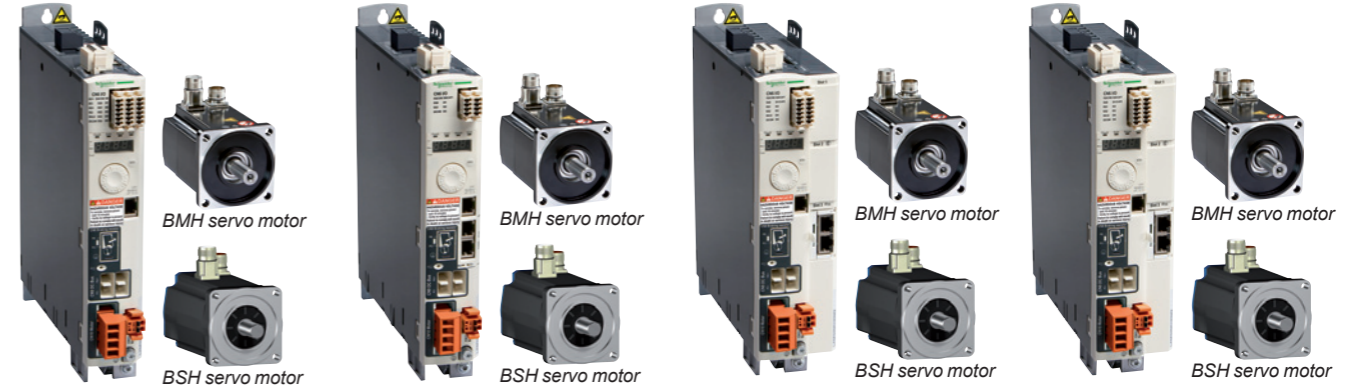

0.15...11 kW/0.25...15 HP	0.15...0.8 kW/0.25...1 HP
0.3...1.6 kW/0.5...2 HP	0.35...11 kW/0.5...15 HP
–	–

Nominal speed:	–
■ BMH servo motors: continuous stall torque range of 1.2...88 Nm for nominal speeds from 1,200 to 5,000 rpm	–
■ BSH servo motors: continuous stall torque range of 0.5...33.4 Nm for nominal speeds from 2,500 to 6,000 rpm	–

Synchronous motor with sensor feedback for BMH and BSH servo motors	Resolver encoder Analog encoder Digital encoder
SinCos Hiperface® sensor	–

–	Peak current, up to 4 times the drive direct current for 1 second
–	1: STO (Safe Torque Off)
–	4: SLS (Safe Limited Speed), SS1 (Safe Stop 1), SS2 (Safe Stop 2), SOS (Safe Operating Stop)

2	–
6, reassignable	4, reassignable
2	–
5, reassignable	2, reassignable
–	3, reassignable

Modbus Serial Link, Pulse train, ± 10V	Modbus Serial Link, CANopen, CANmotion	Modbus Serial Link, Pulse train	Modbus Serial Link, sercos III
–	–	CANopen, CANmotion, DeviceNet, EtherNet/IP, PROFIBUS DP V1, EtherCAT	–

Available as an option	SoMove setup software Multi-Loader configuration tool Graphic display terminal Filters, braking resistors, line chokes
------------------------	---

IEC 61800-5-1, IEC 61800-3 (environments 1 and 2, categories C2 and C3), IEC 61000-4-2/4-3/4-4/4-5, ISO/EN 13849-1 (PL e), IEC 61508 SIL 3 level
CE, UL, CSA, TÜV

LXM 32C	LXM 32A	LXM 32M	LXM 32S
Please refer to the "Lexium 32 motion control" catalog			



Example with six 45 mm wide drives mounted side-by-side



Synergy between Altivar 32 drive and Lexium 32 servo drive (1)

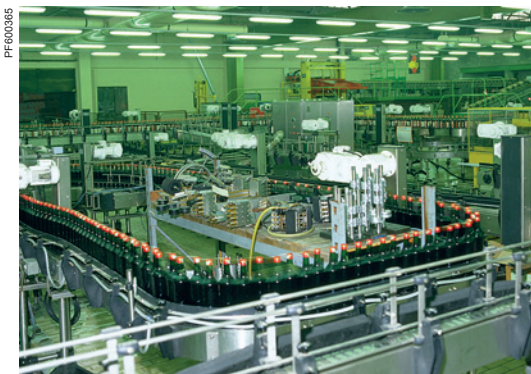

Application: conveying

Presentation

The Altivar 32 drive is a frequency inverter for 200...500 V three-phase asynchronous and synchronous motors rated from 0.18 to 15 kW/0.25 to 20 HP.

The Altivar 32 drive includes various motor control profiles for three-phase asynchronous and synchronous motors.

In combination with synchronous motors, Altivar 32 variable speed drives offer optimized energy efficiency. Their high dynamic response optimizes application performance. The Altivar 32 variable speed drive/synchronous motor combination is very compact, and thus helps to reduce the size of the equipment as well as its cost.

By taking account of constraints on product setup and use right from the design stage, we have been able to simplify integration of the Altivar 32 drive into industrial machines. It features more than 150 functions. It is robust, compact, and easy to install.

Up to 4 kW/5 HP, the Altivar 32 drive is 45 or 60 mm/1.77 or 2.36 in. wide, saving a considerable amount of space in an installation. It has also been designed to be mounted side-by-side or on its side in densely-packed or shallow enclosures.

Altivar 32 drives provide safety functions and control system functions to meet the requirements of the most specialized applications.

They offer various optional communication cards enabling seamless integration into the main control system architectures. The numerous configurable I/O available as standard facilitate customization to specific applications.

Simplified setup and use

Examples of solutions to simplify setup and use:

- Compatible HMI and configuration tools for Altivar 32 variable speed drives and Lexium 32 servo drives (SoMove setup software, SoMove Mobile software for cell phones, remote display terminals, and the Simple Loader and Multi-Loader configuration tools)
- Embedded Bluetooth® link available with **ATV32H●●●●●437** references (see page 10)
- Easy-fit communication cards in cassette format
- Option for connection to the CANopen machine bus
- Different mounting options depending on the machine (vertical, horizontal, with the option to offset the control module when the drive is mounted on its side (to save space depthwise), side-by-side)
- Quick connect for a TeSys GV2L magnetic circuit-breaker (can be equipped with numerous TeSys accessories)
- Labeled terminals
- Synergy with Lexium 32 servo drives for controlling applications involving asynchronous and synchronous motors (common tools and options, same shape and dimensions, etc.)

Altivar 32 drives are also compatible with SoMachine, the software solution for OEMs. This solution can be used to develop, configure, and set up an entire machine in a single software environment.

Applications

Altivar 32 drives incorporate functions suitable for the most common applications, including:

- Material handling (small conveyors, hoists, etc.)
- Packing and packaging machines (small bagging machines, labeling machines, etc.)
- Special machines (mixers, kneaders, transfer machines, textile machines, etc.)
- Pumps, compressors, fans
- Hoisting
- Wood-working machinery (saws, gummers, planers, etc.)
- Metal processing (bending presses, welding machines, cutting machines, etc.)

(1) Please refer to the Lexium 32 motion control offer on our website www.schneider-electric.com.

Innovative functions (1)



Example of an application requiring the use of safety functions

Safety functions

The Altivar 32 range of variable speed drives provides safety functions (SIL 3 according to standard IEC 61508) comparable with performance level “e” (PL e) according to standard ISO/EN 13849-1-2.

The Altivar 32 drive software includes three safety functions that help machines meet safety requirements, whether or not they are used in conjunction with a Preventa safety module (2):

- STO: Safe Torque Off
- SLS: Safely Limited Speed
- SS1: Safe Stop 1

These safety functions are configured via the SoMove setup software.

For more information, please refer to the SoMove catalog available on our website www.schneider-electric.com.

Note: To set up the safety functions, please refer to the “Altivar 32 Safety Functions Manual”, available on our website www.schneider-electric.com.

ATV Logic

ATV Logic is used to adapt Altivar 32 variable speed drives to specific applications by means of customizable integrated control system functions.

The integrated control system functions featuring ATV Logic can be used to perform simple operations without adding further devices, which reduces costs.

ATV Logic is programmed via the SoMove setup software (refer to the SoMove catalog available on our website www.schneider-electric.com) and provides access to the following functions:

- Arithmetical operations, Boolean operators, counters, timers, etc.
- Programming of up to 50 functions by an automated sequence
- Access to the drive’s internal variables

Functions dedicated to synchronous motors

Altivar 32 variable speed drives integrate new functions for synchronous motors that are suitable for the majority of commercially-available motors.

- Simplified setting due to the reduced number of configuration parameters (4 maximum)
- Autotuning of the drive/motor combination
- High frequency injection for high performance in open loop mode

Application functions

Altivar 32 drives include 150 functions for handling, such as:

- Configurations: standard or customizable
- Settings: factory or OEM
- Application-specific functions (conveying, cutting, hoisting, etc.)
- Adjustable switching frequency for optimizing servo control (adjusted motor current, reduced motor noise and temperature rise, etc.)
- Multiple Human-Machine Interfaces (HMIs) and dialog or configuration tools
- Menu parameter setting, using the “My Menu” function to obtain an application-specific HMI
- Uploads and downloads of application and drive software, with the power on or off



Example of an application (scrolling billboard) requiring a typical ATV Logic sequence

Examples of use (functions/applications)

Functions	Applications				
	Handling	Conveying	Packing	Wood-working machinery	Metal processing
Safety functions	■	■	■	■	■
Communication buses and networks	■	■	■	■	■
Fast response time	■	■	■	■	■
Control profile for synchronous motors	■	■	■	■	■
Application-specific functions	■	■	■	■	■
	Typical use			Not applicable	

(1) Non-exhaustive list; please consult our website www.schneider-electric.com.

(2) Please refer to the “Safety functions and solutions using Preventa” catalog.



ATV32H018M2...H075M2
ATV32H037N4...HU15N4



ATV32HU11M2...HU22M2
ATV32HU22N4...HU40N4

The offer

The Altivar 32 range of variable speed drives covers motor power ratings from 0.18 kW/0.25 HP to 15 kW/20 HP with two types of power supply:

- 200 V...240 V single-phase, 0.18 kW/0.25 HP to 2.2 kW/3 HP (ATV32H●●●M2)
 - 380 V...500 V three-phase, 0.37 kW/0.50 HP to 15 kW/20 HP (ATV32H●●●N4)
- Several drives can be mounted side-by-side to save space.

Altivar 32 drives integrate the Modbus and CANopen communication protocols as standard. Both can be accessed via the RJ45 connector on the front of the drive. To simplify connection of the Altivar 32 drive to the CANopen machine bus, three dedicated communication cards are available with different connectors:

- CANopen daisy chain card with two RJ 45 connectors
- CANopen card with 9-way SUB-D connector
- CANopen card with 5-way terminal block

See pages 22 and 23.

In addition to the Modbus and CANopen standard protocols, Altivar 32 drives can be connected to the main industrial communication buses and networks by adding one of the following optional communication cards:

- Modbus/TCP - Ethernet/IP
- PROFIBUS DP V1
- DeviceNet
- EtherCAT
- POWERLINK
- ProfiNet

See page 20.

Electromagnetic compatibility (EMC)

The built-in EMC filters in ATV32H●●●M2 and ATV32H●●●N4 drives and compliance with EMC requirements simplify installation and provide an economical means of helping to ensure devices meet the criteria for the CE mark. This enables compliance with standard IEC 61800-3, category C2 for a maximum motor cable length of 10 m/32.80 ft for ATV32●●●M2 variable speed drives and 5 m/16.40 ft for ATV32●●●N4 variable speed drives.

This filter can be disconnected via a jumper.

Other filters are available as an option and can be installed by the customer to reduce the level of emissions from Altivar 32 drives.

In particular, they allow a maximum motor cable length of 100 m/328.08 ft.

See page 18.

External accessories and options

External accessories and options are available with Altivar 32 drives. The type of external accessories and options depends on the drive rating.

Accessories

- Bracket for direct mounting of GV2/ATV32 circuit-breaker (see page 26)
 - Adapter for mounting the control module at 90°, for mounting the power module on its side, keeping the control module visible and accessible
 - Daisy chain DC bus cordsets for daisy chain connection of the DC bus
- See page 11.

External options

- Braking resistors
 - Line chokes
 - Motor chokes
 - Additional EMC filters
 - Speed monitoring card
- See pages 15 to 19.



CANopen communication card with RJ 45 connectors



CANopen communication card with SUB-D connector



CANopen communication card with connection via terminals



GV2/ATV 32 direct mounting



The offer (continued)

Dialog and configuration tools

Human-Machine interface

The 4-digit display **1** displays drive states, detected faults, and parameter values. The navigation button **2** is used to navigate through the menus, modify values, and change the motor speed in local mode.

HMI terminals

Altivar 32 drives can be connected to a remote display terminal **4** or a remote graphic display terminal **3**, which are available as options.

The remote display terminal can be mounted on an enclosure door with IP 54 or IP 65 degree of protection. It provides access to the same functions as the Human-Machine interface.

The remote graphic display terminal, with its text display in the user's language, provides a user-friendly interface for configuration, debugging, or maintenance. It can also be mounted on an enclosure door with IP 54 or IP 65 degree of protection. See page 12.

SoMove setup software

SoMove setup software is used to configure, adjust, debug (using the Oscilloscope function), and maintain Altivar 32 drives in the same way as for other Schneider Electric drives and starters.

It can be used with a direct cable connection or a Bluetooth® wireless connection (1). For more information, please refer to the SoMove catalog available on our website www.schneider-electric.com.

SoMove Mobile software for cell phones

For the product ranges with the Bluetooth® Link embedded (ATV32H●●●●●437), SoMove Mobile software can be used to edit the drive parameters from a cell phone via a Bluetooth® wireless connection (1).

It can also be used to save configurations. These configurations can be imported or exported from a PC via a Bluetooth® wireless connection (1).

See page 14.

Simple Loader and Multi-Loader configuration tools

The Simple Loader tool **6** enables the configuration from one powered-up drive to be duplicated on another powered-up drive.

The Multi-Loader tool **5** enables configurations from a PC or drive to be copied and duplicated on another drive; the drives do not need to be powered up.

See page 14.

(1) For the product ranges with the Bluetooth® link embedded (ATV32H●●●●●437), see page 10.

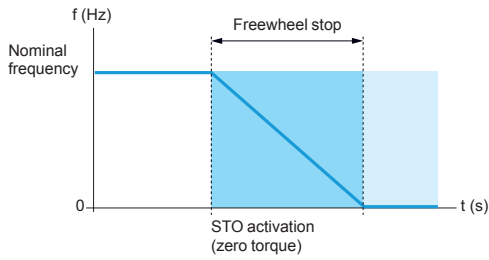

Activation of the STO safety function

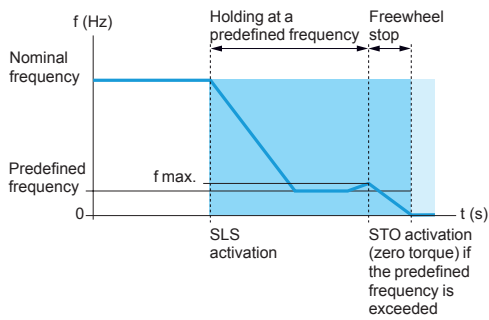

Activation of the SLS safety function

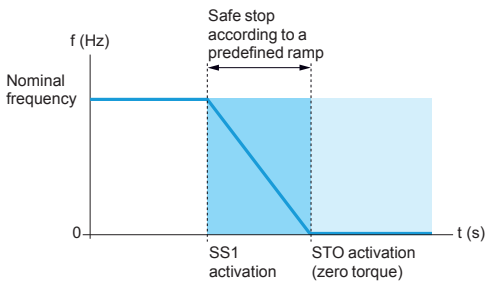

Activation of the SS1 safety function

Integrated safety functions (1)

Altivar 32 drives include three safety functions:

- STO: Safe Torque Off
- SLS: Safely Limited Speed
- SS1: Safe Stop 1

These three functions are certified in accordance with IEC 61800-5-2 Ed.1 “Adjustable speed electrical power drive systems - Part 5-2: Safety requirements - Functional”.

These integrated functions make it possible to:

- Simplify setup of machines that require a complex safety device
- Improve performance during maintenance by reducing machine or installation downtime

Note: Some applications may require the addition of external Preventa safety modules (2).

Safe Torque Off (STO) safety function (1)

The STO integrated safety function causes a motor freewheel stop by helping to eliminate the torque on the motor shaft.

Safely Limited Speed (SLS) safety function (1)

The SLS integrated safety function slows down then holds the motor at a predefined frequency. If this predefined frequency cannot be held above a certain value, for example in the case of a driving load, the STO function is activated.

Safe Stop 1 (SS1) safety function (1)

The SS1 integrated safety function causes a category 1 safe stop.

This stop occurs in the following sequence:

- The motor is stopped according to a predefined deceleration ramp.
- The deceleration is monitored to check that the motor has stopped or that the frequency has been reached.
- The STO function is activated.

Setting up the integrated safety functions (1)

Setting up the integrated safety functions in the Altivar 32 drive does not require any options or additional accessories.

The functions are connected directly to the drive’s logic inputs and can be configured using the SoMove setup software.

For more information, please refer to the SoMove catalog available on our website www.schneider-electric.com.

(1) Please refer to the “Altivar 32 Safety Functions Manual”, available on our website www.schneider-electric.com.

(2) Please refer to the “Safety functions and solutions using Preventa” catalog.

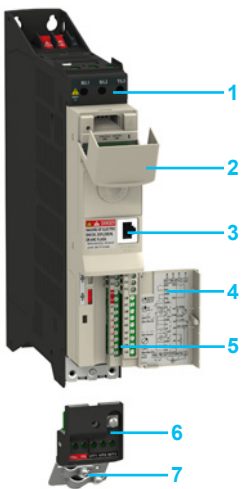

Description

- 1 Power terminals
- 2 Protective cover to prevent access to the power terminals 7 when closed
- 3 RJ 45 communication port for access to integrated protocols: Modbus serial link and CANopen machine bus
- 4 Protective cover for access to the control terminals (also includes a label with a wiring diagram)
- 5 Control terminals for I/O connection:
 - 6 logic inputs:
 - 1 positive logic input (Sink)
 - 1 negative logic input (Source)
 - 1 input configurable as a PTC probe input
 - 1 x 20 kHz pulse control input
 - 1 logic output:
 - 24 V $\overline{\text{---}}$, impedance 3.5 K Ω , sampling time 8 ms
 - 3 analog inputs:
 - 1 current analog input, by programming X and Y from 0 to 20 mA, impedance 250 Ω
 - 1 bipolar differential analog input ± 10 V, impedance 30 Ω
 - 1 voltage analog input ± 10 V, impedance 30 Ω
 - 1 analog output configurable for current and voltage:
 - Voltage analog output 0...10 V $\overline{\text{---}}$, minimum load impedance 470 Ω
 - Current analog output 0...20 mA, maximum load impedance 800 Ω
 - 2 relay outputs:
 - 1 NC contact and 1 NO contact with common point
 - Minimum switching capacity 5 mA for 24 V $\overline{\text{---}}$, maximum switching capacity 3 A on resistive load, 2 A on inductive load for 250 V \sim or 30 V $\overline{\text{---}}$
 - 1 NC contact, maximum switching capacity 5 A on resistive load
- 6 Removable motor power terminal block (allows quick disconnect and re-connect of motor cables during maintenance operations)
- 7 EMC mounting plate (integral part of the motor power terminal block 6). This plate is supplied with a cable guide support, which can be used if required.

Standards and certifications (1)

- Altivar 32 drives have been developed to conform to the strictest international standards and recommendations relating to industrial electrical control devices (IEC), in particular:
- IEC 61800-5-1
 - IEC 61800-3:
 - EMC immunity: IEC 61800-3, Environments 1 and 2
 - Conducted and radiated EMC emissions: IEC 61800-3, category C2
 - ISO/EN 13849-1/-2 category 3 (PL d)
 - IEC 61508 (parts 1 & 2)
 - IEC 60721-3-3 classes 3C3 and 3S2, environments 3C3 and 3S3

Altivar 32 drives are certified:

- UL 508c
- CSA
- NOM
- GOST
- C-Tick

They are CE marked according to the European low voltage (2006/95/EC) and EMC (2004/108/EC) directives.

They also comply with environmental directives (RoHS).

(1) Complete list of certifications and characteristics available on our website www.schneider-electric.com.

Variable speed drives

Altivar 32

Drives



ATV32H018M2...H075M2
ATV32H037N4...HU15N4



ATV32HU11M2...HU22M2
ATV32HU22N4...HU40N4



ATV32HU55N4, HU75N4
EMC plate not mounted



ATV32HD11N4, HD15N4
EMC plate not mounted

Drives (frequency range from 0.1 to 599 Hz)											
Motor Power indicated on rating plate	Line supply					Altivar 32				Reference	Weight
	Max. line current (1), (2)		Apparent power	Max. prospective line Isc (3)		Max. continuous output current (In) (4)	Max. transient current for 60 s	Power dissipated at maximum output current (In) (4)			
	at U1	at U2	at U2			at U2	60 s	W			

kW	HP	A	A	kVA	kA	A	A	W		kg/lb
Single-phase supply voltage: 200...240 V 50/60 Hz, with integrated EMC filter (2) (5) (6)										
0.18	1/4	3.4	2.8	0.7	1	1.5	2.3	25	ATV32H018M2	2.400/ 5.291
0.37	1/2	6	5	1.2	1	3.3	5	38	ATV32H037M2	2.400/ 5.291
0.55	3/4	7.9	6.7	1.6	1	3.7	5.6	42	ATV32H055M2	2.400/ 5.291
0.75	1	10.1	8.5	2	1	4.8	7.2	51	ATV32H075M2	2.400/ 5.291
1.1	1 1/2	13.6	11.5	2.8	1	6.9	10.4	64	ATV32HU11M2	2.900/ 6.393
1.5	2	17.6	14.8	3.6	1	8	12	81	ATV32HU15M2	2.900/ 6.393
2.2	3	23.9	20.1	4.8	1	11	16.5	102	ATV32HU22M2	2.900/ 6.393

Three-phase supply voltage: 380...500 V 50/60 Hz, with integrated EMC filter (2) (5) (6)										
0.37	1/2	2.1	1.6	1.4	5	1.5	2.3	27	ATV32H037N4	2.500/ 5.511
0.55	3/4	2.8	2.2	1.9	5	1.9	2.9	31	ATV32H055N4	2.500/ 5.511
0.75	1	3.6	2.7	2.3	5	2.3	3.5	37	ATV32H075N4	2.500/ 5.511
1.1	1 1/2	5	3.8	3.3	5	3	4.5	50	ATV32HU11N4	2.500/ 5.511
1.5	2	6.5	4.9	4.2	5	4.1	6.2	63	ATV32HU15N4	2.500/ 5.511
2.2	3	8.7	6.6	5.7	5	5.5	8.3	78	ATV32HU22N4	3.000/ 6.613
3	–	11.1	8.4	7.3	5	7.1	10.7	100	ATV32HU30N4	3.000/ 6.613
4	5	13.7	10.5	9.1	5	9.5	14.3	125	ATV32HU40N4	3.000/ 6.613
5.5	7 1/2	20.7	14.5	17.9	22	14.3	21.5	233	ATV32HU55N4	7.500/ 16.535
7.5	10	26.5	18.7	22.9	22	17	25.5	263	ATV32HU75N4	7.500/ 16.535
11	15	36.6	25.6	31.7	22	27.7	41.6	403	ATV32HD11N4	8.700/ 19.180
15	20	47.3	33.3	41	22	33	49.5	480	ATV32HD15N4	8.800/ 19.401

Dimensions (overall)		
Drives	W x H x D	
	EMC plate mounted	EMC plate not mounted
	mm/in.	mm/in.
ATV32H018M2...H075M2, ATV32H037N4...HU15N4	45 x 317 x 245/1.77 x 12.5 x 9.65	– (6)
ATV32HU11M2...HU22M2, ATV32HU22N4...HU40N4	60 x 317 x 245/2.36 x 12.5 x 9.65	– (6)
ATV32HU55N4, HU75N4	150 x 308 x 232/5.91 x 12.1 x 9.13	150 x 232 x 232/5.91 x 9.13 x 9.13
ATV32HD11N4, HD15N4	180 x 404 x 232/7.09 x 15.9 x 9.13	180 x 330 x 232/7.09 x 13.0 x 9.13

(1) Typical value for a 4-pole motor and a maximum switching frequency of 4 kHz, with no line choke for maximum prospective line Isc (3).
 (2) Nominal supply voltage, min. U1, max. U2: 200 (U1)...240 V (U2), 380 (U1)...500 V (U2).
 (3) If line Isc is greater than the values in the table, add line chokes (see page 16).
 (4) These values are given for a nominal switching frequency of 4 kHz, for use in continuous operation. The switching frequency is adjustable from 2 to 16 kHz. Above 4 kHz, derate the nominal drive current. The nominal motor current should not exceed this value. See the derating curves on our website www.schneider-electric.com.
 (5) Drives supplied with category C2 integrated EMC filter. This filter can be disconnected.
 (6) Connection in compliance with EMC standards:
 - ATV32H●●M2, ATV32H037N4...HU40N4 drives are supplied with an EMC plate. This is an integral part of the power terminals; these 2 components cannot be separated.
 - ATV32HU55N4...HD15N4 drives are supplied with an EMC plate, for assembly by the customer.

PF065123



ATV32HU15N4 with control module mounted at 90°

Variants

Variable Speed Drive with Integrated Bluetooth®

The drives with integrated Bluetooth® communication can be ordered via adding 437 suffix at the end of all the standard product reference.

For example: ATV32HU40N4 becomes ATV32HU40N4437.

The variant product with Bluetooth® Link embedded is supplied with the identical characters of the standard offer, and the combinations of variant drives with the accessories and options are required to be under the same principle as the corresponding standard drives.

Accessories

Components for mounting GV2 circuit-breaker directly on ATV32 drive

Description	For drives	Sold in lots of	Unit reference	Weight kg/lb
Bracket for GV2/ATV32 direct mounting Mechanical bracket for holding the GV2 circuit-breaker in place when directly mounted on ATV32 drive. Requires a GV2AF4 adapter plate for electrical connection, to be ordered separately.	ATV32H●●●M2 ATV32H037N4...HU40N4	10	VW3A9921	0.075/ 0.165
Adapter plate Provides the electrical link between the GV2 circuit-breaker and ATV32 drive when GV2/ATV32 directly mounted. Requires a VW3A9921 bracket for direct mounting, to be ordered separately.	ATV32H●●●M2 ATV32H037N4...HU40N4	10	GV2AF4	0.016/ 0.035

Mounting the control module at 90°

Description	For drives	Reference	Weight kg/lb
Adapter for mounting the control module at 90° This is used to mount the power module on the side, keeping the control module visible and accessible	ATV32H●●●M2 ATV32H037N4...HU40N4	VW3A9920	0.125/ 0.276

Daisy chain connection of the DC bus (1)

The DC bus is connected in a daisy chain in the following cases:

- Drives powered by the AC supply with parallel connection of the DC bus in order to balance the loads during braking phases between the drives; used in addition to braking resistors (see page 15)
- Drives powered by the DC bus only

Requires the connection accessories listed below:

Description (1)	Use		Length m/ft	Sold in lots of	Reference	Weight kg/lb
	From	To				
Cordset (1) equipped with 2 connectors	ATV32H●●●M2 ATV32H●●●N4	ATV32H●●●M2 ATV32H●●●N4	0.1/ 0.33	5	VW3M7101R01	—
Shielded cable	ATV32H●●●M2 ATV32H●●●N4 ATV32H●●●M2 ATV32H●●●N4	ATV32H●●●M2 ATV32H●●●N4 LXM 32●●●●M2 (2) LXM32●●●●N4 (2)	15/ 49.21	1	VW3M7102R150	—
Connection kit for VW3M7102R150 cable	—	—	—	10	VW3M2207	—

(1) Setting up several devices on the DC bus requires special precautions; please refer to the installation manual available on our website www.schneider-electric.com.

(2) Lexium 32 motion control offer. See page 2 and visit our website www.schneider-electric.com.

PF065121



ATV32H●●●M2 connected with a daisy chain DC bus cordset



Remote display terminal with cover open



Remote display terminal with cover closed



Remote graphic display terminal

Remote display terminal

This terminal is used to locate the Human-Machine Interface of the Altivar 32 drive remotely on the door of an enclosure with IP 54 or IP 65 protection.

It is used to:

- Control, adjust, and configure the drive remotely
 - Display the drive status and detected faults remotely
- Its maximum operating temperature is 50°C/122°F.

Description

- 1 4-digit display
- 2 Navigation ▲, ▼ and selection ENT, ESC keys
- 3 Motor local control keys:
 - RUN: Starts the motor
 - FWD/REV: Reverses the direction of rotation of the motor
 - STOP/RESET: Stops the motor/clears detected faults
- 4 Operating mode selection key MODE
- 5 Cover controlling access to the motor local control keys

References

Description	Degree of protection	Length	Reference	Weight
		m/ft		
Remote display terminals A remote-mounting cordset, VW3A1104R●●, is also required	IP 54	–	VW3A1006	0.250/ 0.551
	IP 65	–	VW3A1007	0.275/ 0.606
Remote-mounting cordsets equipped with 2 RJ45 connectors	–	1.0/ 3.28	VW3A1104R10	0.050/ 0.110
		3.0/ 9.84	VW3A1104R30	0.150/ 0.331

Remote graphic display terminal

This remote graphic display terminal, common across Schneider Electric's variable speed drive ranges, provides a user-friendly interface for configuration, debugging, and maintenance. In particular, it is possible to transfer and store up to 4 configurations.

For portable use or mounted on an enclosure door, it can also be connected to multiple drives (see page 13).

Its main functions are as follows:

- The graphic screen displays 8 lines of 24 characters of plain text.
- The navigation button provides quick and easy access to the drop-down menus.
- It is supplied with 6 languages installed (Chinese, English, French, German, Italian and Spanish). The available languages can be modified using the Multi-Loader configuration tool (VW3A8121).

Its maximum operating temperature is 60°C/140°F, and it features IP 54 protection; this can be increased to IP 65 when mounted on an enclosure door.

Description

- 6 Graphic display:
 - 8 lines of 24 characters, 240 x 160 pixels, large digit display
- 7 Function keys (not operational on the Altivar 32)
- 8 Navigation button:
 - Rotate ±: Goes to the next/previous line, increases/decreases the value
 - Press: Saves the current value (ENT)

ESC key: Aborts a value, parameter, or menu to return to the previous selection
- 9 Motor local control keys:
 - RUN: Starts the motor
 - STOP/RESET: Stops the motor/clears detected drive faults
 - FWD/REV: Reverses the direction of rotation of the motor



Portable use of the remote graphic display terminal:
1 + 2 + 3



Using the remote graphic display terminal on
enclosure door:
1 + 2 + 4 (+ 5, if IP 65)

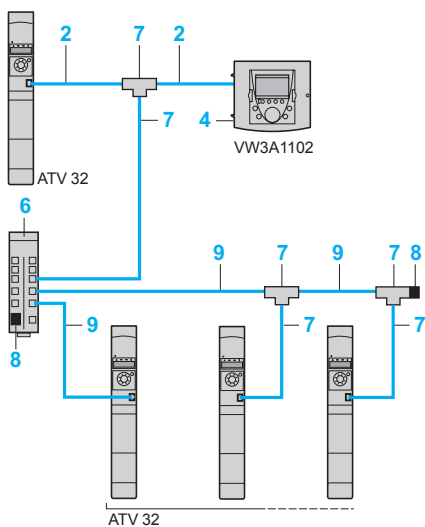

Example of connection via multidrop link

Remote graphic display terminal (continued)

Remote mounting accessories for the graphic display terminal

Description	Item no.	Length m/ft	Reference	Weight kg/lb
Remote graphic display terminal A remote-mounting cordset, VW3A1104R●●●, and an RJ45 adapter, VW3A1105, are required	1	–	VW3A1101	0.180/ 0.396
Remote-mounting cordsets equipped with 2 RJ45 connectors Remote operation of the Altivar 32 and the remote graphic display terminal VW3A1101	2	1.0/ 3.28 3.0/ 9.84 5.0/ 16.40 10/ 32.81	VW3A1104R10 VW3A1104R30 VW3A1104R50 VW3A1104R100	0.050/ 0.110 0.150/ 0.331 0.250/ 0.551 0.500/ 1.102
Female/female RJ45 adapter	3	–	VW3A1105	0.010/ 0.022
Remote mounting kit For mounting on enclosure door IP 54 degree of protection	4	–	VW3A1102	0.150/ 0.331
Door Used to increase the degree of protection for remote mounting kit VW3A1102 to IP 65 To be mounted on remote mounting kit VW3A1102	5	–	VW3A1103	0.040/ 0.088

Additional accessories for multidrop connection

Description	Item no.	Order in lots of	Unit reference	Weight kg/lb
Modbus splitter box 10 RJ45 connectors and 1 screw terminal block	6	–	LU9GC3	0.500/ 1.102
Modbus T-junction boxes With integrated cable (0.3 m/0.98 ft)	7	–	VW3A8306TF03	–
With integrated cable (1.0 m/3.28 ft)	7	–	VW3A8306TF10	–
Modbus line terminator For RJ45 connector R = 120 Ω, C = 1 nf	8	2	VW3A8306RC	0.010/ 0.022

Description	Item no.	Length m/ft	Reference	Weight kg/lb
Cordsets for Modbus serial link equipped with 2 RJ45 connectors	9	0.3/ 0.98 1.0/ 3.28 3.0/ 9.84	VW3A8306R03 VW3A8306R10 VW3A8306R30	0.025/ 0.055 0.060/ 0.132 0.130/ 0.287

Example of connection via multidrop link

All the components described on this page enable a remote graphic display terminal to be connected to several drives via a multidrop link. This multidrop link is connected to the RJ45 port on the Modbus/CANopen communication port. See the example opposite.



Configuration with SoMove Mobile software for cell phones via Bluetooth®



VW3A8121



VW3A8120



Configuring an Altivar 32 in its packaging:
VW3A8121 + VW3A8126 cordset

SoMove Mobile software for cell phones (1)

SoMove Mobile software “transforms” any compatible cell phone (1) into a remote graphic display terminal that can be used for a Human-Machine Interface (see page 12).

Particularly suitable for on-site or remote maintenance operations, SoMove Mobile software can be used to print out and save configurations, import them from a PC, and export them to a PC or drive equipped with Bluetooth® (2).

The SoMove Mobile software and drive configuration files can be downloaded from our website www.schneider-electric.com.

References

Description	For drives	Reference	Weight kg/lb
SoMove Mobile software for cell phones (1) Can be downloaded from our website www.schneider-electric.com .	ATV32H●●●●●437	–	–

SoMove setup software

SoMove lite setup software for PC is used to prepare drive configuration files.

For more information, please refer to the SoMove catalog available on our website www.schneider-electric.com.

Simple Loader and Multi-Loader configuration tools

The Simple Loader tool enables one drive’s configuration to be duplicated and transferred to another drive (both drives must be powered up). It is connected to the drive’s RJ45 communication port.

The Multi-Loader tool enables a number of configurations from a PC or drive to be copied and loaded onto other drives (Altivar 32 drives do not need to be powered up when using the Multi-Loader tool).

References

Designation	Reference	Weight kg/lb
Simple Loader configuration tool Supplied with a cordset equipped with 2 RJ45 connectors	ATV32H●●●●● VW3A8120	–
Multi-Loader configuration tool Supplied with: - 1 cordset equipped with 2 RJ45 connectors - 1 cordset equipped with one type A USB connector and one mini B USB connector - 1 SD memory card - 1 female/female RJ 45 adapter - 4 AA/LR6 1.5 V batteries - 1 anti-shock protector - 1 carrying handle	ATV32H●●●●● VW3A8121	–
Cordset for Multi-Loader tool For connecting the Multi-Loader tool to the Altivar 32 drive in its packaging. Equipped with a non-locking RJ45 connector with special mechanical catch on the drive end and an RJ45 connector on the Multi-Loader end.	ATV32H●●●●● in its packaging VW3A8126	–

(1) SoMove Mobile software requires a cell phone with minimum features; please consult our website www.schneider-electric.com.

(2) For the product ranges with the Bluetooth® link embedded (ATV32H●●●●●437), see page 10.

Presentation

Braking resistors allow Altivar 32 drives to operate while braking to a standstill or during slowdown braking, by dissipating the braking energy. They enable maximum transient braking torque.

Depending on the drive rating, two types of resistor are available:

- Enclosed model (IP 20 casing) designed to comply with the EMC standard and protected by a temperature-controlled switch or thermal overload relay
- Enclosed model (IP 65 casing) with cordset, for ATV32H●●●M2 and ATV32H037N4...HU75N4 drives

Note: To optimize the size of the braking resistor, the DC buses on Altivar 32 drives in the same application can be connected in parallel (see page 11).

Applications

Machines with high inertia, driving loads, and machines with fast cycles.

References

For drives	Minimum value of the resistor to be connected	Ohmic value	Average power available at 50°C/122°F (1)	Length of connection cable	Reference	Weight
	Ω	Ω	W	m/ft		
IP 65 braking resistors						
ATV32H018M2...H075M2	40	100	25	0.75/ 2.46	VW3A7608R07	0.410/ 0.904
ATV32H037...H075N4	80			3.0/ 9.84	VW3A7608R30	0.760/ 1.675
ATV32HU11N4...HU22N4	54					
ATV32HU11M2, HU15M2	27	72	25	0.75/ 2.46	VW3A7605R07	0.620/ 1.367
				3.0/ 9.84	VW3A7605R30	0.850/ 1.874
ATV32HU22M2	25	27	50	0.75/ 2.46	VW3A7603R07	0.930/ 2.050
				3.0/ 9.84	VW3A7603R30	1.200/ 2.645
ATV32HU30N4	54	72	50	0.75/ 2.46	VW3A7606R07	0.930/ 2.050
ATV32HU40N4	36			3.0/ 9.84	VW3A7606R30	1.200/ 2.645
ATV32HU55N4, HU75N4	27	27	100	0.75/ 2.46	VW3A7604R07	1.420/ 3.131
				3.0/ 9.84	VW3A7604R30	1.620/ 3.571
IP 20 braking resistors						
ATV32H018M2...H075M2	40	100	50	–	VW3A7701	2.000/ 4.409
ATV32HU11M2, HU15M2	27					
ATV32H037N4...H075N4	80					
ATV32HU11N4...HU30N4	54					
ATV32HU40N4	36					
ATV32HU22M2	25	60	100	–	VW3A7702	2.400/ 5.291
ATV32HU55N4, HU75N4	27					
ATV32HD11N4, HD15N4	16	28	200	–	VW3A7703	3.500/ 7.716

(1) Load factor for resistors: the value of the average power that can be dissipated at 50°C/122°F from the resistor into the casing is determined for a load factor during braking that corresponds to the majority of normal applications:

- 2 s braking with a 0.6 Tn braking torque for a 40 s cycle
- 0.8 s braking with a 1.5 Tn braking torque for a 40 s cycle



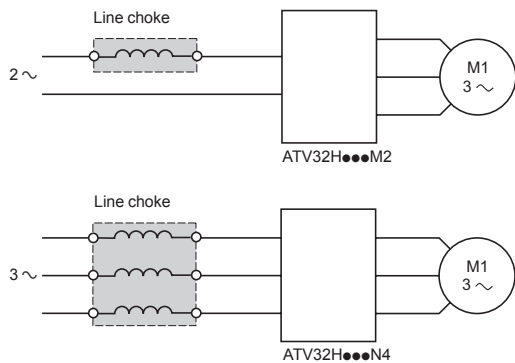

Presentation

Line chokes, also known as line reactors, provide improved protection against overvoltages on the line supply and can reduce harmonic distortion of the current produced by the drive.

The recommended chokes limit the line current. They have been developed in line with standard IEC 61800-5-1 (VDE 0160 level 1 high-energy overvoltages on the line supply).

The inductance values are defined for a voltage drop between 3% and 5% of the nominal line voltage. Values higher than this will cause loss of torque.

The use of line chokes is recommended in particular under the following circumstances:

- Line supply with significant disturbance from other equipment (interference, overvoltages)
- Line supply with voltage imbalance between phases > 1.8% of nominal voltage
- Drive supplied by a line with very low impedance (in the vicinity of a power transformer 10 times more powerful than the drive rating)
- Installation of a large number of frequency inverters on the same line
- Reduction of overloads on the $\cos \varphi$ correction capacitors, if the installation includes a power factor correction unit

The prospective short-circuit current at the point of connection of the drive must not exceed the maximum value indicated in the reference tables (see page 10). The use of chokes allows connection to the following line supplies:

- Max. I_{sc} 22 kA for 200/240 V
- Max. I_{sc} 65 kA for 380/500 V

References

Drive		Choke				Reference	Weight
Reference	Line current without choke		Line current with choke				
	U min. (1)	U max. (1)	U min. (1)	U max. (1)			
	A	A	A	A		kg/lb	
Single-phase supply voltage: 200...240 V 50/60 Hz							
ATV32H018M2	3.0	2.5	2.1	1.8	VZ1L004M010	0.630/ 1.389	
ATV32H037M2	5.3	4.4	3.9	3.3			
ATV32H055M2	6.8	5.8	5.2	4.3	VZ1L007UM50	0.880/ 1.940	
ATV32H075M2	8.9	7.5	7.0	5.9			
ATV32HU11M2	12.1	10.2	10.2	8.6	VZ1L018UM20	1.990/ 4.387	
ATV32HU15M2	15.8	13.3	13.4	11.4			
ATV32HU22M2	21.9	18.4	19.2	16.1			
Three-phase supply voltage: 380...500 V 50/60 Hz							
ATV32H037N4	2.2	1.7	1.1	0.9	VW3A4551	1.500/ 3.307	
ATV32H055N4	2.8	2.2	1.4	1.2			
ATV32H075N4	3.6	2.7	1.8	1.5			
ATV32HU11N4	4.9	3.7	2.6	2			
ATV32HU15N4	6.4	4.8	3.4	2.6			
ATV32HU22N4	8.9	6.7	5	4.1	VW3A4552	3.000/ 6.613	
ATV32HU30N4	10.9	8.3	6.5	5.2			
ATV32HU40N4	13.9	10.6	8.5	6.6			
ATV32HU55N4	21.9	16.5	11.7	9.3	VW3A4553	3.500/ 7.716	
ATV32HU75N4	27.7	21	15.4	12.1			
ATV32HD11N4	37.2	28.4	22.5	18.1	VW3A4554	6.000/ 13.228	
ATV32HD15N4	48.2	36.8	29.6	23.3			

(1) Nominal supply voltage:

For drives	Nominal voltage	
	U min.	U max.
ATV32H...M2	200	240
ATV32H...N4	380	500

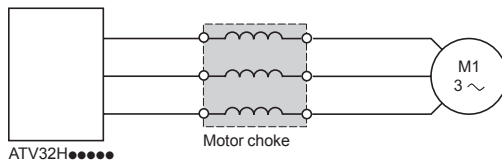

Presentation

Motor chokes, also known as load reactors, can be inserted between the Altivar 32 drive and the motor to:

- Limit the dv/dt at the motor terminals (500 to 1500 V/μs), for cables longer than 50 m/164.04 ft
- Filter interference caused by the opening of a contactor placed between the filter and the motor
- Reduce the motor ground leakage current
- Smooth the motor current wave form to reduce motor noise

References (1)

For drives	Losses	Cable length (2)		Nominal current	Reference	Weight
		Shielded cable	Unshielded cable			
	W	m/ft	m/ft	A		kg/lb
Single-phase supply voltage: 200...240 V 50/60 Hz						
ATV32HU22M2	75	≤ 100/ 328.08	≤ 200/ 656.17	16	VW3A4553	3.500/ 7.716
Three-phase supply voltage: 380...500 V 50/60 Hz						
ATV32HU22N4... HU40N4	65	≤ 100/ 328.08	≤ 200/ 656.17	10	VW3A4552	3.000/ 6.613
ATV32HU55N4	75	≤ 100/ 328.08	≤ 200/ 656.17	16	VW3A4553	3.500/ 7.716
ATV32HU75N4, HD11N4	90	≤ 100/ 328.08	≤ 200/ 656.17	30	VW3A4554	6.000/ 13.228
ATV32HD15N4	80	≤ 100/ 328.08	≤ 200/ 656.17	60	VW3A4555	11.000/ 24.251

(1) For ATV32H018M2...HU15M2 and ATV32H037N4...HU15N4 drives, please contact our Customer Care Centre.

(2) For an application with several motors connected in parallel, the total motor cable lengths must be added together. If a cable longer than that recommended is used, the filters may overheat.



VW3A4422 + ATV32HU11N4

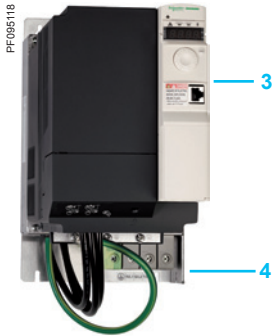

VW3A4424 + ATV32HU55N4



VW3A4422



VW3A4424

Presentation

Integrated filters

Altivar 32 drives have integrated radio interference input filters to comply with the EMC (Electromagnetic Compatibility) standard for variable speed electrical power drive products IEC 61800-3 category C2 and the European EMC Directive. The integrated EMC filters comply with standard IEC 61800-3 for a maximum motor cable length of 10 m/32.81 ft for ATV32●●●M2 variable speed drives and 5 m/16.40 ft for ATV32●●●N4 variable speed drives.

Additional EMC input filters

The additional EMC input filters enable the drives to meet more stringent requirements; they are designed to reduce conducted emissions on the line supply below the limits of standard IEC 61800-3 category C1 or C2 (see page 19).

Mounting

Depending on the model, the additional EMC filters can be mounted beside or underneath the drive. They act as a support for the drives and are attached to them via tapped holes.

Mounting the filter on the side of the drive:

- 1 ATV32H●●●M2, ATV32H037N4...HU40N4 drives
- 2 Additional EMC input filters

Mounting the filter underneath the drive:

- 3 ATV32HU55N4...HD15N4 drives
- 4 Additional EMC input filters

Use according to the type of line supply

Additional EMC filters can only be used on TN (neutral connection) and TT (grounded neutral) type systems.

Standard IEC 61800-3, appendix D2.1, states that on IT systems (isolated or impedance grounded neutral), filters can cause permanent insulation monitors to operate in a random manner.

The effectiveness of additional filters on this type of system depends on the type of impedance between neutral and ground, and therefore cannot be predicted.

If a machine has to be installed on an IT system, one solution is to insert an isolation transformer and connect the machine locally on a TN or TT system.

The radio interference input filters integrated in Altivar 32 drives can easily be disconnected by means of a selector switch without removing the drive.

Additional EMC input filters

For drives	Additional EMC input filter				Mounting the filter/ATV32	Reference	Weight
Reference	Maximum length of shielded cable (1) (2)		In (3)	Losses (4)			
	IEC 61800-3 (5)						
	Category C2	Category C1	A	W			kg/lb
Single-phase supply voltage: 200...240 V 50/60 Hz							
ATV32H018M2	50/ 164.04	20/ 65.61	10.1	3.7	On the side	VW3A4420	0.600/ 1.323
ATV32H037M2							
ATV32H055M2							
ATV32H075M2							
ATV32HU11M2	50/ 164.04	20/ 65.61	17.6	6.9	On the side	VW3A4421	0.775/ 1.709
ATV32HU15M2							
ATV32HU22M2	50/ 164.04	20/ 65.61	23.9	7.5	On the side	VW3A4426	1.130/ 2.491
Three-phase supply voltage: 380...500 V 50/60 Hz							
ATV32H037N4	50/ 164.04	20/ 65.61	15	9.9	On the side	VW3A4422	0.900/ 1.984
ATV32H055N4							
ATV32H075N4							
ATV32HU11N4							
ATV32HU15N4							
ATV32HU22N4							
ATV32HU30N4							
ATV32HU40N4							
ATV32HU55N4	100/ 328.08	10/ 32.81	47	19.3	Underneath	VW3A4424	3.150/ 6.944
ATV32HU75N4							
ATV32HD11N4	100/ 328.08	10/ 32.81	49	27.4	Underneath	VW3A4425	4.750/ 10.472
ATV32HD15N4							

(1) The filter selection tables give the maximum lengths for shielded cables connecting motors to drives. These maximum lengths are given as examples only, as they vary depending on the stray capacitance of the motors and the cables used. If motors are connected in parallel, it is the total length of all cables that should be taken into account.

(2) These values are given for a nominal switching frequency of 4 kHz.

(3) In: nominal filter current.

(4) Via heat dissipation, at the nominal filter current (In).

(5) Standard IEC 61800-3: EMC immunity and conducted and radiated EMC emissions:

- category C1: public power supply (residential)

- category C2: industrial power supply



VW3A3620

Presentation

The VW3A3620 speed monitoring card is recommended for hoisting applications. It is able to detect a problem with the load in a hoisting application such as a crane thanks to its load slip detection function. When a problem is detected, the speed monitoring card activates the brake.

Additional functions

A fault is triggered by a comparison between the ramp output and the encoder speed feedback. If a fault is detected, the drive will switch to a freewheel stop. If the brake logic control function has been configured, the brake command will be deactivated.

Faults are detected when:

- The difference between the feedback speed and the output frequency is more than a certain percentage of the nominal motor frequency. Only positive differences can be controlled. In a downward direction (negative speed) the load cannot be moved faster than the reference speed.
- The direction of the encoder is different from the reference direction.

Speed monitoring card

Description	Reference	Weight kg/lb
Speed monitoring card	VW3A3620	0.300/ 0.660
Port: One 6-way screw connector		
■ RS422		
■ Tension nominale d'entrée : 5 V		

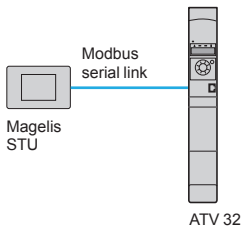

Example of configuration on Modbus serial link

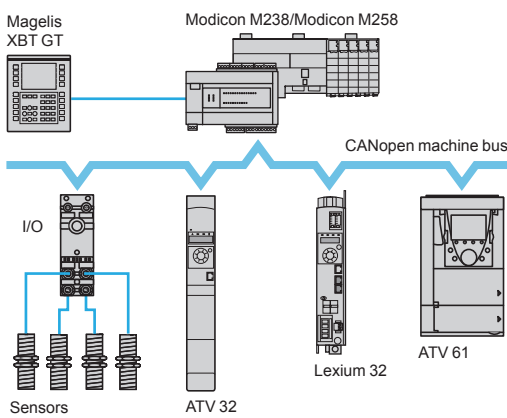

Example of configuration on CANopen machine bus

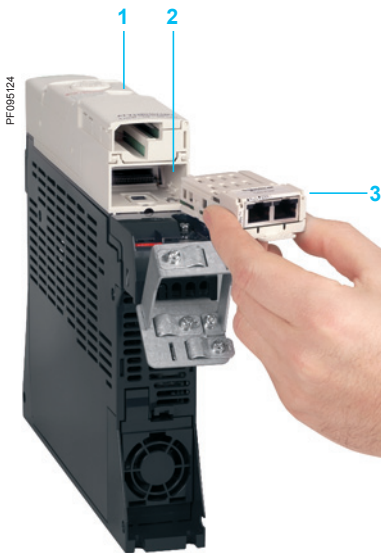

Example of installing a communication card 3 (view of underside)

Presentation

Altivar 32 drives are designed to meet the configuration requirements found in the main industrial communication installations. The Modbus and CANopen communication protocols are integrated as standard and can be accessed directly via the RJ45 communication port located on the front. Altivar 32 drives can also be connected to other industrial communication buses and networks by using one of the communication cards available as an option. Communication cards are supplied in "cassette" format for ease of mounting/removal.

Modbus serial link (1)

The Modbus serial link is used for connecting the following HMI and configuration tools:

- Magelis HMI terminal
- Remote display terminal, remote graphic display terminal
- SoMove setup software, Simple Loader and Multi-loader configuration tools

CANopen machine bus (1) (2) (3)

The CANopen machine bus is used for integration into control system architectures, especially when combined with Modicon M238 and M258 logic controllers or Lexium 32 motion controllers.

Optimized solutions for connection to the CANopen machine bus

To simplify setting up the Altivar 32 drive, three dedicated CANopen communication cards (2) are available depending on the connection and connector types:

- CANopen daisy chain card with 2 RJ45 connectors offering an optimized solution for daisy chain connection to the CANopen machine bus (see page 22)
- CANopen card for connection to the bus via 9-way SUB-D connector (see page 22)
- CANopen card for connection to the bus via terminals (see page 23)

Using one of the CANopen communication cards also reduces the installation dimensions compared to using VW3CANTAP2 and TSXCANTDM4 junction boxes.

Communication cards for industrial applications (3)

The following communication cards are available:

- Modbus TCP and EtherNet/IP
- PROFIBUS DP V1
- DeviceNet
- EtherCAT
- POWERLINK
- ProfiNet

Description

Altivar 32 drives have been designed to simplify connections to communication buses and networks with:

- 1 Integrated RJ45 communication port for Modbus/CANopen on the front
- 2 Slot for the communication card
- 3 Communication card

(1) The Modbus serial link always uses the RJ45 communication port located on the front. If simultaneous use of the Modbus serial link and the CANopen machine bus is required, a CANopen communication card is needed.

(2) When one of the CANopen communication cards is inserted in the Altivar 32 drive, CANopen communication via the RJ45 communication port on the front is disabled.

(3) The Altivar 32 drive can only take one communication card.

Functions

All Altivar 32 drive functions can be accessed via the communication buses and networks:

- Control
- Monitoring
- Adjustment
- Configuration

The speed reference and command may come from different sources:

- Logic input or analog I/O terminals
- Communication bus or network
- Remote display terminals

The Altivar 32 drive's advanced functions can be used to manage switching of these drive control sources according to the application requirements.

The communication periodic I/O data assignment can be selected using the network configuration software.

The Altivar 32 drive can be controlled:

- According to the CiA 402 native profile
- According to the I/O profile

Communication is monitored according to criteria specific to each protocol.

Regardless of protocol type, the reaction of the drive to a detected communication fault can be configured as follows:

- Freewheel stop, stop on ramp, fast stop, or braked stop
- Maintain the last command received
- Fallback position at a predefined speed
- Ignore the detected fault

Modbus serial link (1)

Connection accessories for remote Human-Machine Interface (2)

Description	Item no.	Length m/ft	Reference	Weight kg/lb
Cordsets for Modbus serial link equipped with 2 RJ45 connectors	1	0.3/0.98	VW3A8306R03	0.025/ 0.055
		1.0/3.28	VW3A8306R10	0.060/ 0.132
		3.0/9.84	VW3A8306R30	0.130/ 0.287

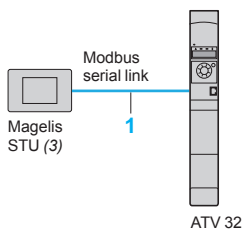

Example of connection of an Altivar 32 drive and a Magelis STU HMI terminal via the Modbus serial link

(1) The Modbus serial link always uses the RJ45 communication port located on the front. If simultaneous use of the Modbus serial link and the CANopen machine bus is required, a CANopen communication card is needed.

(2) See page 12 for connection of a remote display terminal or remote graphic display terminal.

(3) Requires a 24 V $\bar{\text{V}}$ power supply. Please refer to the "Human/Machine interfaces" catalog.

Variable speed drives

Altivar 32

Communication buses and networks



VW3A3608

Modicon M238/Modicon M258 (7)

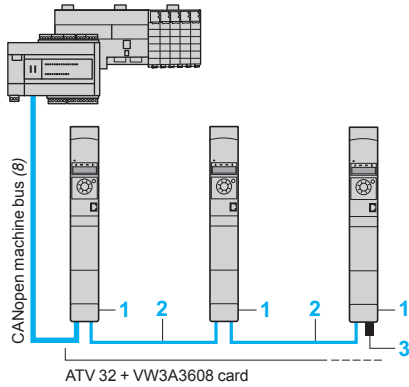

Optimized solution for daisy chain connection to the CANopen machine bus

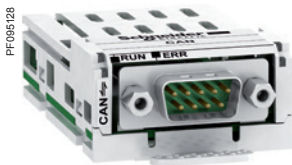

VW3A3618

Modicon M238/Modicon M258 (7)

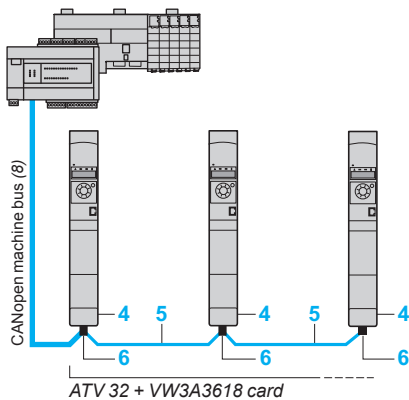

Example of connection to the CANopen machine bus via SUB-D connector

CANopen machine bus (1)

Description	Item no.	Length m/ft	Unit reference	Weight kg/lb
-------------	----------	-------------	----------------	--------------

Connection with VW3A3608 CANopen daisy chain card (optimized solution for daisy chain connection to the CANopen machine bus)

CANopen daisy chain communication card (2) (3)	1	–	VW3A3608	–
---	----------	---	-----------------	---

Ports: 2 RJ45 connectors

CANopen cordsets equipped with 2 RJ45 connectors	2	0.3/ 0.98	VW3CANCARR03	0.050/ 0.110
		1.0/ 3.28	VW3CANCARR1	0.500/ 1.102

CANopen line terminator for RJ45 connector (4)	3	–	TCSCAR013M120	–
---	----------	---	----------------------	---

Connection via SUB-D connector with VWA3618 CANopen card

CANopen communication card (2) (3)	4	–	VW3A3618	–
---	----------	---	-----------------	---

Port: 1 x 9-way male SUB-D connector

CANopen cable Standard cable, CE marking Low smoke zero halogen Flame retardant (IEC 60332-1)	5	50/ 164.04	TSXCANCA50	4.930/ 10.869
		100/ 328.08	TSXCANCA100	8.800/ 19.401
		300/ 984.25	TSXCANCA300	24.560/ 54.145

CANopen cable Standard cable, UL certification, CE marking Flame retardant (IEC 60332-2)	5	50/ 164.04	TSXCANCB50	3.580/ 7.892
		100/ 328.08	TSXCANCB100	7.840/ 17.284
		300/ 984.25	TSXCANCB300	21.870/ 48.215

CANopen cable Cable for harsh environments (5) or mobile installations, CE marking Low smoke zero halogen Flame retardant (IEC 60332-1)	5	50/ 164.04	TSXCANCD50	3.510/ 7.738
		100/ 328.08	TSXCANCD100	7.770/ 17.130
		300/ 984.25	TSXCANCD300	21.700/ 47.840

CANopen IP 20 straight connector 9-way female SUB-D with line terminator that can be deactivated	6	–	TSXCANKCDF180T	0.049/ 0.108
---	----------	---	-----------------------	-----------------

IP 20 CANopen right angle connector (6) 9-way female SUB-D with line terminator that can be deactivated	6	–	TSXCANKCDF90T	0.046/ 0.101
--	----------	---	----------------------	-----------------

- (1) The Modbus serial link always uses the RJ45 communication port located on the front. If simultaneous use of the Modbus serial link and the CANopen machine bus is required, a CANopen communication card is needed.
- (2) The Altivar 32 drive can only take one communication card.
- (3) When one of the CANopen communication cards is inserted in the Altivar 32 drive, CANopen communication via the RJ45 communication port on the front is disabled.
- (4) Sold in lots of of 2.
- (5) Standard environment:
 - No particular environmental constraints
 - Operating temperature between + 5 and + 60°C/41 and 140°F
 - Fixed installation
 Harsh environment:
 - Resistance to hydrocarbons, industrial oils, detergents, solder splashes
 - Relative humidity up to 100%
 - Saline atmosphere
 - Operating temperature between - 10 and + 70°C/14 and 158°F
 - Significant temperature variations
- (6) Incompatible with side-by-side mounting.
- (7) Please refer to the "Modicon M238 logic controller" and "Modicon M258 logic controller" catalogs.
- (8) Cable dependent on the type of controller or PLC; please refer to the corresponding catalog.



VW3A3628

Modicon M238/Modicon M258 (5)

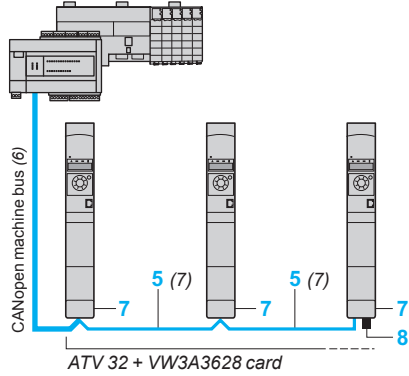

Example of connection to the CANopen machine bus via screw terminals

CANopen machine bus (continued) (1)

Description	Item no.	Length m/ft	Unit reference	Weight kg/lb
Connection via terminals with VW3A3628 CANopen card				
CANopen communication card (2) (3) Port: 1 x 5-way screw terminal block	7	–	VW3A3628	–
CANopen line terminator for screw terminal connector (4)	8	–	TCSCAR01NM120	–

Other connection accessories and cordsets

IP 20 CANopen cordsets equipped with 2 x 9-way female SUB-D connectors. Standard cable, CE marking Low smoke zero halogen Flame retardant (IEC 60332-1)	–	0.3/ 0.98	TSXCANCADD03	0.091/ 0.201
	1.0/ 3.28	TSXCANCADD1	0.143/ 0.315	
	3.0/ 9.84	TSXCANCADD3	0.295/ 0.650	
	5.0/ 16.40	TSXCANCADD5	0.440/ 0.970	
	–	–	–	–
IP 20 CANopen cordsets equipped with 2 x 9-way female SUB-D connectors. Standard cable, UL certification, CE marking Flame retardant (IEC 60332-2)	–	0.3/ 0.98	TSXCANCBDD03	0.086/ 0.190
	1.0/ 3.28	TSXCANCBDD1	0.131/ 0.289	
	3.0/ 9.84	TSXCANCBDD3	0.268/ 0.591	
	5.0/ 16.40	TSXCANCBDD5	0.400/ 0.882	
	–	–	–	–
IP 20 CANopen junction boxes equipped with: ■ 4 x 9-way male SUB-D connectors + screw terminal block for trunk cable tap link ■ Line terminator	–	–	TSXCANTDM4	0.196/ 0.432
IP 20 CANopen junction boxes equipped with: ■ 2 screw terminal blocks for trunk cable tap link ■ 2 RJ45 connectors for connecting drives ■ 1 RJ45 connector for connecting a PC	–	–	VW3CANTAP2	0.480/ 1.058

(1) The Modbus serial link always uses the RJ45 communication port located on the front. If simultaneous use of the Modbus serial link and the CANopen machine bus is required, a CANopen communication card is needed.
 (2) The Altivar 32 drive can only take one communication card.
 (3) When one of the CANopen communication cards is inserted in the Altivar 32 drive, CANopen communication via the RJ45 communication port on the front is disabled.
 (4) Sold in lots of 2.
 (5) Please refer to the "Modicon M238 logic controller" and "Modicon M258 logic controller" catalogs.
 (6) Cable dependent on the type of controller or PLC; please refer to the corresponding catalog.
 (7) See page 22 for item "5".



VW3A3616

Modicon M340 (4)

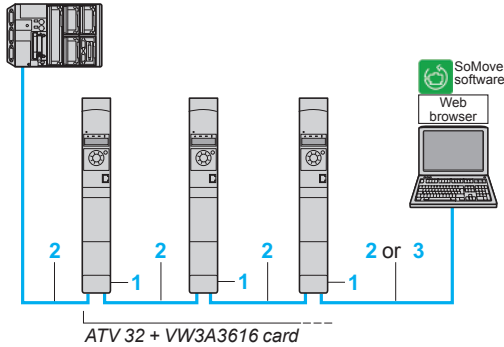

Example of connection on an EtherNet/IP network

Modbus TCP network and EtherNet/IP network (1)

Description	Item no.	Length m/ft (3)	Reference	Weight kg/lb
-------------	----------	-----------------	-----------	--------------

Communication card

Modbus TCP and EtherNet/IP network card	1	–	VW3A3616	0.300/ 0.661
--	----------	---	-----------------	-----------------

For connection to the Modbus TCP network or EtherNet/IP network
 Ports: 2 RJ45 connectors
 ■ 10/100 Mbps, half duplex and full duplex
 ■ Embedded Web server

Requires cordsets
 490NTW000●●/●●U or
 490NTC000●●/●●U

ConneXium cordsets (2) (3)

Straight shielded twisted pair cordsets	2	2.0/ 6.56	490NTW00002	–
equipped with 2 RJ45 connectors		5.0/ 16.40	490NTW00005	–
Conforming to EIA/TIA-568 category 5 and IEC 11801/EN 50173-1, class D standards		12/ 39.37	490NTW00012	–

Crossed shielded twisted pair cordsets	3	5.0/ 16.40	490NTC00005	–
equipped with 2 RJ45 connectors		15/ 49.21	490NTC00015	–
Conforming to EIA/TIA-568 category 5 and IEC 11801/EN 50173-1, class D standards				

Straight shielded twisted pair cables	2	2.0/ 6.56	490NTW00002U	–
equipped with 2 RJ45 connectors		5.0/ 16.40	490NTW00005U	–
Conforming to UL and CSA 22.1 standards		12/ 39.37	490NTW00012U	–

Crossed shielded twisted pair cordsets	3	5.0/ 16.40	490NTC00005U	–
equipped with 2 RJ45 connectors		15/ 49.21	490NTC00015U	–
Conforming to UL and CSA 22.1 standards				

(1) The Altivar 32 drive can only take one communication card.
 (2) For other ConneXium connection accessories, please refer to our website www.schneider-electric.com.
 (3) Also available in 40 m/131.23 ft and 80 m/262.46 ft lengths (2).
 (4) Please refer to the "M340 Automation platform" catalog.

PF095130



VW3A3607

PROFIBUS DP V1 bus (1)

Description	Reference	Weight kg/lb
PROFIBUS DP V1 communication card Port: 1 x 9-way female SUB-D connector Conforming to PROFIBUS DP V1 Profiles supported: ■ CiA 402 drive ■ Profidrive Offers several message handling modes based on DP V1	VW3A3607	0.140/ 0.308

PF095140

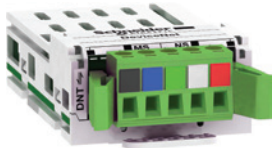

VW3A3609

DeviceNet bus (1)

Description	Reference	Weight kg/lb
DeviceNet communication card Port: 1 removable 5-way screw connector Profiles supported: ■ CIP AC DRIVE ■ CiA 402 drive	VW3A3609	—

PF102822



VW3A3601

EtherCAT bus (1)

Description	Reference	Weight kg/lb
EtherCAT communication card Port: 2 RJ45 connectors	VW3A3601	—

PF095144



VW3A3619

POWERLINK network (1)

Description	Reference	Weight kg/lb
Ethernet POWERLINK communication card Port: 2 RJ45 connectors	VW3A3619	0.300/ 0.660

PF130913



VW3A3627

ProfiNet network (1)

Description	Reference	Weight kg/lb
ProfiNet communication card Port: 2 RJ45 connectors	VW3A3627	0.300/ 0.660

(1) The Altivar 32 drive can only take one communication card.

Variable speed drives

Altivar 32

Motor starters: circuit-breaker + drive

Applications

The proposed combinations can help protect people and equipment when a short-circuit occurs on the power stage.

Two types of combination are possible:

- Drive + circuit-breaker: minimum combination
The circuit-breaker can be mounted directly on ATV32H●●●M2 and ATV32H037N4...HU40N4 drives using the bracket for GV2/ATV32 direct mounting (VW3A9921) and the adapter plate (GV2AF4) (see page 11).
- Drive + circuit-breaker + contactor: minimum combination with contactor when a control circuit is needed.

The circuit-breaker provides protection against accidental short-circuits, disconnection and, if necessary, isolation.

The contactor controls and manages any protection functions. A contactor can be used downstream of the drive to help ensure the motor is isolated on stopping. In this case, the contactor size should be category AC-3 depending on the associated motor, only for operation between 25 Hz and 500 Hz.

The Altivar 32 drive is protected electronically against short-circuits between phases and between phase and ground. It therefore provides continuity of service and thermal protection of the motor.

PF09511



GV2/ATV32 direct mounting:
GV2L08 + (VW3A9921 + GV2AF4) (3)
+
ATV32H075N4

Motor starters: circuit-breaker + drive

Standard power ratings of three-phase 4-pole 50/60 Hz motors (2)		Variable speed drive Reference	Circuit-breaker (1)	
kW	HP		Reference	Circuit-breaker mounted directly on ATV32
Single-phase supply voltage: 200...240 V 50/60 Hz				
0.18	1/4	ATV32H018M2	GV2L08	With accessories VW3A9921 + GV2AF4 (3)
0.37	1/2	ATV32H037M2	GV2L10	
0.55	3/4	ATV32H055M2	GV2L14	
0.75	1	ATV32H075M2	GV2L16	
1.1	1 1/2	ATV32HU11M2	GV2L16	
1.5	2	ATV32HU15M2	GV2L20	
2.2	3	ATV32HU22M2	GV2L22	
Three-phase supply voltage: 380...500 V 50/60 Hz				
0.37	1/2	ATV32H037N4	GV2L07 (4)	With accessories VW3A9921 + GV2AF4 (3)
0.55	3/4	ATV32H055N4	GV2L08 (4)	
0.75	1	ATV32H075N4	GV2L08 (4)	
1.1	1 1/2	ATV32HU11N4	GV2L10 (4)	
1.5	2	ATV32HU15N4	GV2L14 (4)	
2.2	3	ATV32HU22N4	GV2L14 (4)	
3	–	ATV32HU30N4	GV2L16 (4)	
4	5	ATV32HU40N4	GV2L16 (4)	
5.5	7 1/2	ATV32HU55N4	GV2L22	–
7.5	10	ATV32HU75N4	GV2L32	–
11	15	ATV32HD11N4	GV3L40	–
15	20	ATV32HD15N4	GV3L50	–

(1) GV2L, GV3L: TeSys magnetic motor circuit-breakers; accessories (see page 29).

(2) The HP values given are NEC-compliant (National Electrical Code).

(3) To be ordered separately (see page 11).

(4) A GV2P TeSys thermal magnetic circuit-breaker with the same rating can also be used with ATV32H037N4...HU40N4 drives. The thermal release should then be set to maximum to inhibit this function.

Variable speed drives

Altivar 32

Motor starters: circuit-breaker + contactor + drive



GV2L14
+
LC1D09
+
ATV32HU15N4

Motor starters: circuit-breaker + contactor + drive

Standard power rating of 50/60 Hz 4-pole motors (3)		Variable speed drive Reference	Circuit-breaker (1) Reference	Contactor (2) Reference (4)
kW	HP			
Single-phase supply voltage: 200...240 V 50/60 Hz				
0.18	1/4	ATV32H018M2	GV2L08	LC1D09●●
0.37	1/2	ATV32H037M2	GV2L10	LC1D09●●
0.55	3/4	ATV32H055M2	GV2L14	LC1D09●●
0.75	1	ATV32H075M2	GV2L16	LC1D09●●
1.1	1 1/2	ATV32HU11M2	GV2L16	LC1D09●●
1.5	2	ATV32HU15M2	GV2L20	LC1D09●●
2.2	3	ATV32HU22M2	GV2L22	LC1D09●●

Three-phase supply voltage: 380...500 V 50/60 Hz				
0.37	1/2	ATV32H037N4	GV2L07	LC1D09●●
0.55	3/4	ATV32H055N4	GV2L08	LC1D09●●
0.75	1	ATV32H075N4	GV2L08	LC1D09●●
1.1	1 1/2	ATV32HU11N4	GV2L10	LC1D09●●
1.5	2	ATV32HU15N4	GV2L14	LC1D09●●
2.2	3	ATV32HU22N4	GV2L14	LC1D09●●
3	–	ATV32HU30N4	GV2L16	LC1D09●●
4	5	ATV32HU40N4	GV2L16	LC1D09●●
5.5	7 1/2	ATV32HU55N4	GV2L22	LC1D09●●
7.5	10	ATV32HU75N4	GV2L32	LC1D18●●
11	15	ATV32HD11N4	GV3L40	LC1D25●●
15	20	ATV32HD15N4	GV3L50	LC1D32●●

- (1) GV2L, GV3L: TeSys magnetic motor circuit-breakers; accessories (see page 29).
- (2) Composition of TeSys contactors LC1D09/D18/D25/D32: 3 poles + 1 NO auxiliary contact + 1 NC auxiliary contact.
- (3) The HP values given are NEC-compliant (National Electrical Code).
- (4) Replace ●● with the control circuit voltage reference given in the table below:

AC control circuit		24	48	115	230	230/240
LC1D	Volts ~	B7	E7	FE7	P7	U7
	50/60 Hz					

For other voltages between 24 V and 660 V, or a DC control circuit, please refer to the "Motor starter solutions - Control and protection components" catalog or visit www.schneider-electric.com.

Accessories for TeSys circuit-breakers (1)

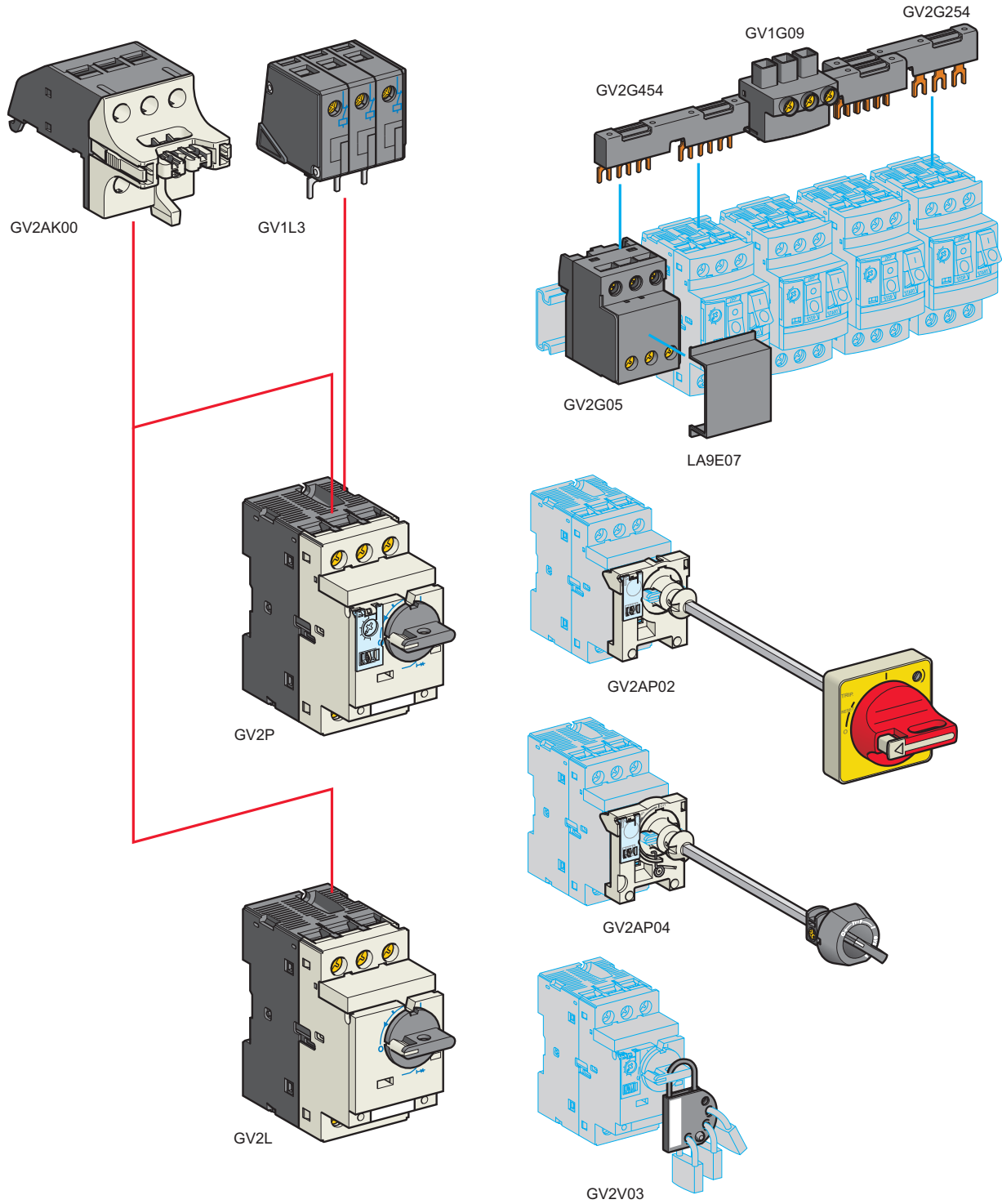

(1) Example of accessories available; see page 29 for full product references.

Variable speed drives

Altivar 32

Accessories for TeSys circuit-breakers

PF095119



Example of GV2/ATV32 direct mounting in an enclosure:
GV2L circuit-breakers + GV2454 and GV2G05 accessories
+
ATV32HU15N4 drives

Accessories for TeSys circuit-breakers (continued) (1)				
Description	For circuit-breaker	Unit reference	Weight kg/lb	
Add-on blocks				
Visible isolation block (2) Max. number: 1	Mounted on front GV2L07...L22, GV2P07...P22	GV2AK00	0.150/ 0.331	
Limiters Max. number: 1	Mounted on the top	GV1L3	0.130/ 0.287	
	Separate	LA9LB920	0.320/ 0.705	
Busbars				
3-pole busbars 63 A, 2 tap links	45 mm/1.77 in. interval	GV2L/GV2P	GV2G245	0.036/ 0.079
	54 mm/2.13 in. interval	GV2L/GV2P	GV2G254	0.038/ 0.084
	72 mm/2.83 in. interval	GV2L/GV2P	GV2G272	0.042/ 0.093
3-pole busbars 63 A, 3 tap links	45 mm/1.77 in. interval	GV2L/GV2P	GV2G345	0.058/ 0.128
	54 mm/2.13 in. interval	GV2L/GV2P	GV2G354	0.060/ 0.132
3-pole busbars 63 A, 4 tap links	45 mm/1.77 in. interval	GV2L/GV2P	GV2G445	0.077/ 0.170
	54 mm/2.13 in. interval	GV2L/GV2P	GV2G454	0.085/ 0.187
	72 mm/2.83 in. interval	GV2L/GV2P	GV2G472	0.094/ 0.207
3-pole busbars 63 A, 5 tap links	45 mm/1.77 in. interval	GV2L/GV2P	GV2G545	0.100/ 0.220
	54 mm/2.13 in. interval	GV2L/GV2P	GV2G554	0.100/ 0.220
Terminal blocks For supplying one or more busbars GV2G●●●	Connection at the top	GV2L/GV2P	GV1G09	0.040/ 0.088
	Can take the GV1L3 limiter	GV2P	GV2G05	0.115/ 0.253
Protective end cover For busbar output awaiting extension <i>(sold in lots of 5)</i>		GV2L/GV2P	GV1G10	0.005/ 0.011
Cover for terminal block For mounting in modular distribution boards <i>(sold in lots of 10)</i>		GV2L/GV2P	LA9E07	0.005/ 0.011
Adapter				
Large Spacing adapter UL 508 type E		GV2P07...P022	GV2GH7	0.040/ 0.088
External controls				
External control Max. enclosure depth 290 mm/11.41 in. Visual OFF indication Red handle, yellow front plate, IP 54 Can be locked with padlock (not supplied)		GV2L, GV2P	GV2AP02	0.200/ 0.441
External control Max. enclosure depth 290 mm/11.41 in. No visual ON/OFF indication Does not lock the door or plug-in base opening control mechanism in the ON position Colour: RAL 7016, IP 54		GV2L, GV2P	GV2AP04	0.104/ 0.229
External control Max. enclosure depth 390 mm/15.35 in. Includes: A handle LU9AP1●, a rod 260 mm/10.24 in. long maximum, a bracket and an adapter. Visual OFF indication Red handle, yellow front plate, IP 54 Can be locked with padlock (not supplied)		GV3L, GV3P	GV3AP02	0.294/ 0.648
Padlocking device				
Padlocking device Can take 4 padlocks (not supplied) ∅ 6 mm/0.24 in. max.		GV2L, GV2P GV3L, GV3P	GV2V03	0.092/ 0.203

(1) For a detailed description and other accessories for circuit-breakers, please refer to the "Motor starter solutions - Control and protection components" catalog or visit www.schneider-electric.com.

(2) 3 poles isolated upstream of GV2L and GV2P circuit-breakers.

4					
490NTC00005	24	TSXCANCA100	22	VW3A7608R07	15
490NTC00005U	24	TSXCANCA300	22	VW3A7608R30	15
490NTC00015	24	TSXCANCADD1	23	VW3A7701	15
490NTC00015U	24	TSXCANCADD03	23	VW3A7702	15
490NTW00002	24	TSXCANCADD3	23	VW3A7703	15
490NTW00002U	24	TSXCANCADD5	23	VW3A8120	14
490NTW00005	24	TSXCANCB50	22	VW3A8121	14
490NTW00005U	24	TSXCANCB100	22	VW3A8126	14
490NTW00012	24	TSXCANCB300	22	VW3A8306R03	13
490NTW00012U	24	TSXCANCBDD1	23	VW3A8306R10	13
		TSXCANCBDD03	23	VW3A8306R30	13
		TSXCANCBDD3	23		21
		TSXCANCBDD5	23	VW3A8306RC	13
A		TSXCANCD50	22	VW3A8306TF03	13
ATV32H018M2	10	TSXCANCD100	22	VW3A8306TF10	13
ATV32H037M2	10	TSXCANCD300	22	VW3A9920	11
ATV32H037N4	10	TSXCANKCDF90T	22	VW3A9921	11
ATV32H055M2	10	TSXCANKCDF180T	22	VW3CANCARR1	22
ATV32H055N4	10	TSXCANTDM4	23	VW3CANCARR03	22
ATV32H075M2	10			VW3CANTAP2	23
ATV32H075N4	10			VW3M2207	11
ATV32HD11N4	10	V		VW3M7101R01	11
ATV32HD15N4	10	VW3A1006	12	VW3M7102R150	11
ATV32HU11M2	10	VW3A1007	12	VZ1L004M010	16
ATV32HU11N4	10	VW3A1101	13	VZ1L007UM50	16
ATV32HU15M2	10	VW3A1102	13	VZ1L018UM20	16
ATV32HU15N4	10	VW3A1103	13		
ATV32HU22M2	10	VW3A1104R10	12		
ATV32HU22N4	10		13		
ATV32HU30N4	10	VW3A1104R30	12		
ATV32HU40N4	10		13		
ATV32HU55N4	10	VW3A1104R50	13		
ATV32HU75N4	10	VW3A1104R100	13		
		VW3A1105	13		
		VW3A3601	25		
G		VW3A3607	25		
GV1G09	29	VW3A3608	22		
GV1G10	29	VW3A3609	25		
GV1L3	29	VW3A3616	24		
GV2AF4	11	VW3A3618	22		
GV2AK00	29	VW3A3619	25		
GV2AP02	29	VW3A3620	19		
GV2AP04	29	VW3A3627	25		
GV2G05	29	VW3A3628	23		
GV2G245	29	VW3A4420	18		
GV2G254	29	VW3A4421	18		
GV2G272	29	VW3A4422	18		
GV2G345	29	VW3A4424	18		
GV2G354	29	VW3A4425	18		
GV2G445	29	VW3A4426	18		
GV2G454	29	VW3A4551	16		
GV2G472	29	VW3A4552	16		
GV2G554	29		17		
GV2GH7	29	VW3A4553	16		
GV2V03	29		17		
GV3AP02	29	VW3A4554	16		
			17		
		VW3A4555	17		
L		VW3A7603R07	15		
LA9E07	29	VW3A7603R30	15		
LA9LB920	29	VW3A7604R07	15		
LU9GC3	13	VW3A7604R30	15		
		VW3A7605R07	15		
		VW3A7605R30	15		
T		VW3A7606R07	15		
TCSCAR01NM120	23	VW3A7606R30	15		
TCSCAR013M120	22				
TSXCANCA50	22				

Altivar drives



Schneider Electric Industries SAS

Head Office
35, rue Joseph Monier
F-92500 Rueil-Malmaison
France

www.schneider-electric.com/drives

The information provided in this documentation contains general descriptions and/or technical characteristics of the performance of the products contained herein. This documentation is not intended as a substitute for and is not to be used for determining suitability or reliability of these products for specific user applications. It is the duty of any such user or integrator to perform the appropriate and complete risk analysis, evaluation and testing of the products with respect to the relevant specific application or use thereof. Neither Schneider Electric nor any of its affiliates or subsidiaries shall be responsible or liable for misuse of the information contained herein.

Design: Schneider Electric
Photos: Schneider Electric

DIA2ED2100401EN