

3000 Series

Temperature/Process Controllers

Improve process efficiency,
product quality and minimise waste



Eurotherm®

by **Schneider** Electric

Control Optimise Simplify

Control Optimise Simplify



Easy to use
technology so
powerful it's simple

3000 Series

Temperature/Process Controllers

Improve process efficiency, product quality and minimise waste with our high accuracy controllers. These feature-rich instruments offer versatility in application and have clear, user friendly operator interfaces. Quickstart features, help text and PC graphical wiring ensure your engineering costs are minimised even with the most sophisticated of configurations.

From the simplest needs... ...to powerful, advanced control

The latest range of controllers from Eurotherm provide our world class excellence in control with clear, user friendly operator interfaces. Quick start codes; automatic help text; custom text messages, and an auto-tune that really works ensures the 3200 range makes high performance control simple to implement and easy to operate.

With the emphasis being on simplicity and available in four standard formats, the 3200 range provides precise temperature control with a host of options. A simple 'QuickStart' code is used to configure all of the essential functions required to control your process and, if preferred, this can be preset by Eurotherm to your requirements. When accessing the controller HMI you will find that every parameter is accompanied by a scrolling text message to describe its function.

The 3200 has a host of advanced features including heater failure detection, timer, setpoint programmer and a recipe feature that is unique in this class of product. All of these features can be configured with an extremely simple to use PC wizard configuration tool. Configurations can be saved to file and reused or modified to suit other applications in the future.

The 3508 and 3504 offer much more than temperature control – advanced features and options make them capable of small machine control. They provide flexible I/O options to control and measure a multitude of processes – temperature, potential, humidity, flow, pressure, level, viscosity, additive dosing and many more. Specialist function blocks, recipe selection, setpoint programmers, maths, logic, timer functions and flexible communication options are just a few examples of what makes these instruments a key part of a total process solution.

3200 Series

Fast initial set-up using QuickStart code

- Enabling 'out of box' operation

Expert configuration by PC wizard

- On-line help explains each step

Recipes can be selected from operator interface

- Easy to adapt for differing process needs

Internal timer and setpoint programming

- Suitable for simple time based profiling applications

Communications

- Integration with PLCs and PCs using Modbus protocol



Quick and easy commissioning with one shot auto-tuning

- No need for expert control knowledge

Easy, comprehensive operator information with custom messages

- Provides clear information of plant conditions with scrolling text

Clear alarm information

- Custom alarm messages that operators understand

Heater failure detection and integral ammeter display

- Instant indication of heater faults with indication of measured current

Analogue remote setpoint

- Economical solution for multi-zone applications

3500 Series

Dual loop

- Ideal for controlling processes with two interactive variables

Precision PV measurement combined with high performance control

- Repeatable performance yielding consistently high product quality

Flexible units with input and output modularity - up to 6 I/O slots with 15 different module types

- Limited stock holding of same basic unit can be adapted to many different applications

QuickStart HMI configures simple applications in minutes

- Faster than it takes for a PC to boot-up. Ideal for replacement of older Eurotherm products such as 818 and 902

Advanced features

- A host of maths, logic and timing features along with zirconia and humidity function blocks offer the ability to develop custom solutions and small machine controllers



OEM Security protects intellectual property

- Prevent unauthorised copying of configurations

A Graphical Wiring Editor makes easy work of creating flexible solutions

- Minimum training required. Easy to document and understand applications

Easy system integration with standard industry protocols – Modbus RTU, Modbus TCP, Profibus and DeviceNet®

- Simple to integrate to SCADA and programmable logic controllers without expert knowledge of communication protocols

Simple and intuitive operation

- Customisable displays to clearly show the process information you need

Flexible Setpoint Programming with dual channel capability

- Up to 50 time based programs can be stored. Programs can be also be created using a PC tool then downloaded to the controller

Products designed to integrate

Designed to integrate seamlessly with programmable logic controllers and other supervisory control and monitoring systems the 3000 Series provides a unique level of system integration.

System integration

By devolving loop control to a 3000 Series controller a PLC is able to concentrate on providing fast and effective logic control without the burden of running complex control algorithms. The 3000 Series controllers also offer better control performance than a PLC, the comfort of single loop integrity and ease of replacement without stopping the process.

A wide range of communication options are catered for by simply plugging in the appropriate module. All units support both RS232 and 2-wire RS485 communications using the Modbus RTU network protocol. Additionally the 3508 and 3504 support 4-wire RS485 and Profibus DP, DeviceNet® and Modbus TCP network protocols.

Serial communications

Utilising one of the most common protocols used within the Industrial Automation market, the Eurotherm implementation of Modbus RTU is based on a fixed address table. Parameter addresses are fixed and do not move depending on how the unit is configured making communication to intelligent masters very easy to accomplish.

Fieldbus networks

Profibus and DeviceNet are used extensively to communicate to Siemens and Allen Bradley programmable logic controllers.

The 3500 range can easily be integrated in machines where loop controllers are required to act as slaves to a PLC.

Using a PC editor the Profibus GSD file required for the PLC can quickly be created by simply selecting parameters from a pick list.

When using DeviceNet the 3500 EDS file can be registered and the parameter input and output tables edited using Allen Bradley's RSNetWorx™ configuration tools.

Ethernet connectivity

Utilising the popular Modbus TCP network protocol the 3500 controllers can be connected to an Ethernet network. This enables plug and play connection to other Eurotherm products such as graphic recorders and third party PLCs or SCADA.

Modbus master

The 3200 provides the facility to broadcast one parameter using Modbus RTU to a number of slave units. Typically this would be used to retransmit a Setpoint to other slave zones within a furnace. The 3500 allows full read/write Modbus RTU communications with multiple slave devices.

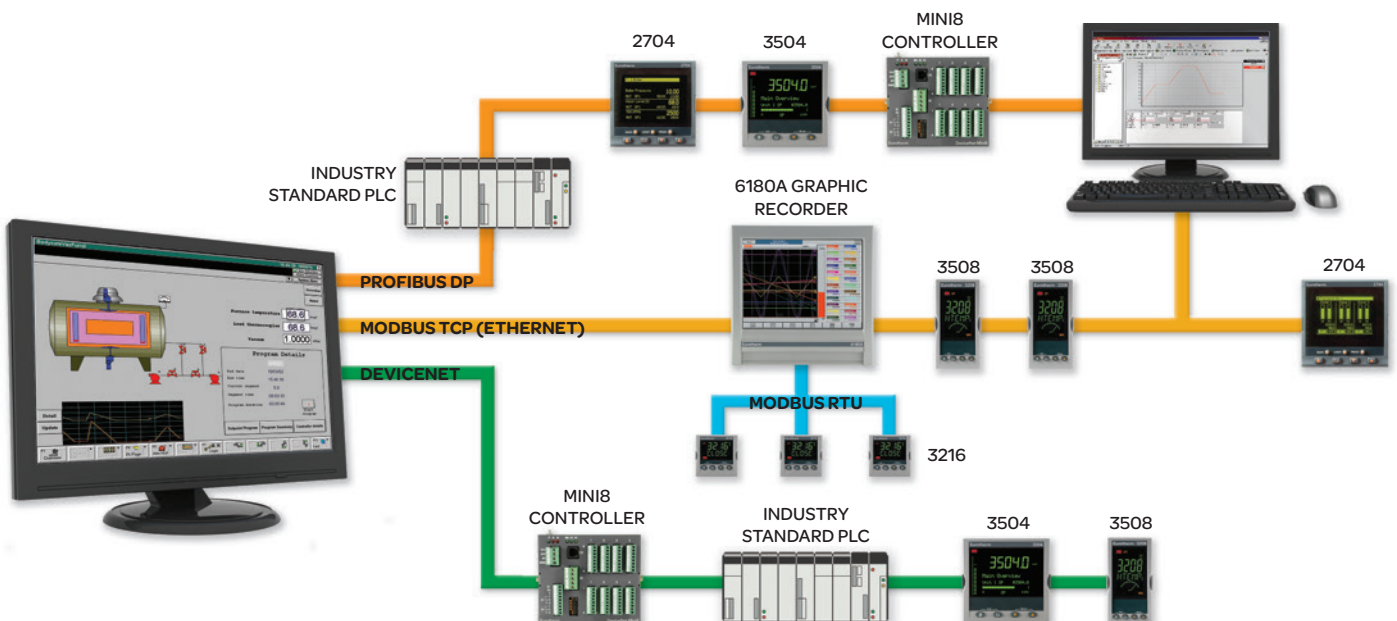

Products designed for ease of use

As well as precision PID control from the World's leading supplier, the 3000 Series controllers offer a host of features that make the units easy to use and configure to save you time and money.

QuickStart code

A simple 10 digit code can be used to set up all of the essential 3200 functions to control your process. If you specify this code at point of order your controller will arrive pre-configured.

Configuration Wizard

Within the supporting PC based software, iTools, are configuration Wizards. These Wizards will guide you through the configuration process with interactive help and graphical demonstration of configuration options.

QuickStart HMI

Eurotherm have designed a QuickStart HMI Wizard for all of the 3500 Range controllers. In just a couple of minutes the controller can be ready for use as the wizard leads the user through all of the basic set up via the instrument HMI. There is no need for additional tools, PCs or even an extensive knowledge of control.

Informative displays

All of the 3000 Series displays provide clear messages and data to ensure operators get the information they need about the plant conditions. They provide, clear, complete text information with a custom message facility – (the 3200 uses scrolling text to maximise clarity for operators) – along with help text for each controller function. The 3508 and 3504 also have user-defined displays to offer views onto the process that are best suited to the operation of the plant.

Heater failure detection

The 3200 range can accommodate a current transformer input that can be used to monitor the status of the heaters. Normally used to provide early indication of a heater fault, this input can also be used to measure the actual current flowing and indicate the value on the front HMI, provide alarm output, or make information available to a supervisory system for power usage calculations.

Easy recipe selection

Recipes can be used to change the operating parameters of the controller or even to change the full configuration - allowing one basic controller to be easily adapted to many applications. Recipes can be selected by the controller HMI using an understandable user defined name, by external hardware signals, or by digital communications.

Config adaptor

PC configuration of all 3000 Series can be achieved by using a configuration adaptor. It gives Eurotherm iTools the ability to communicate and configure devices without any power being connected. This device is ideal for distributors and OEMs who need to stock a wide range of options.

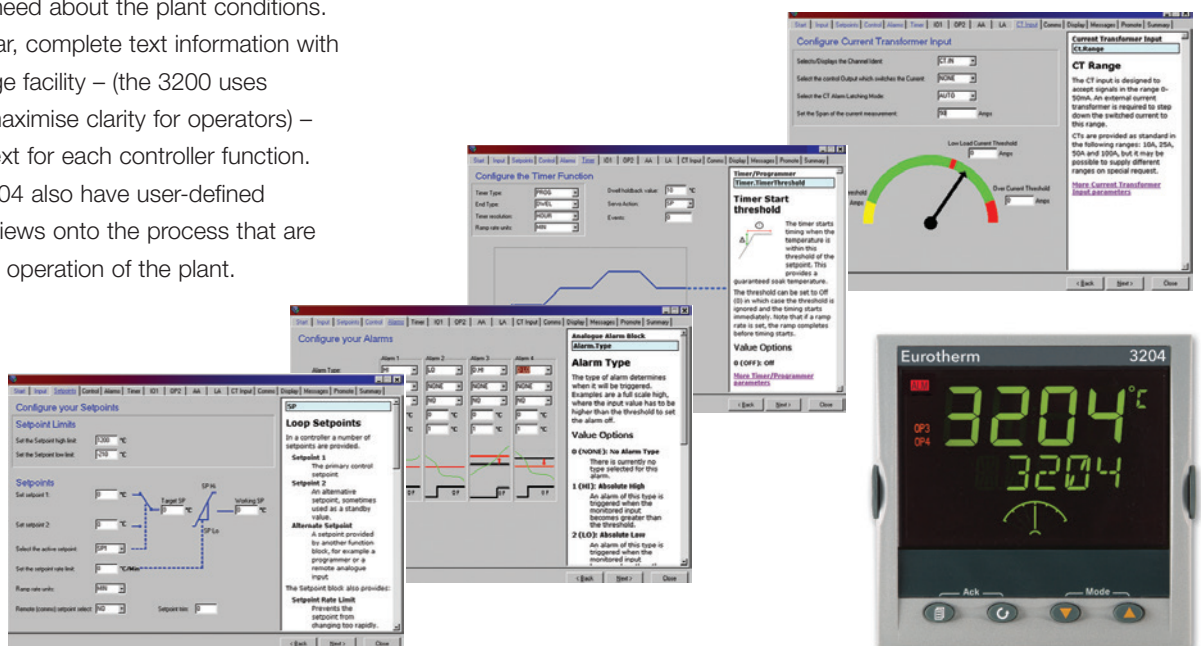

Flexible and Creative Solutions

Graphical Wiring Editor

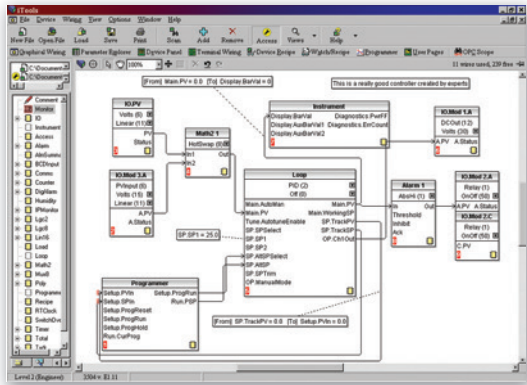

The 3500 is capable of providing simple solutions to demanding applications. Eurotherm iTools includes a Graphical Wiring Editor to quickly implement and document such applications within the controller. This flexible tool provides drag and drop wiring and function block placement to save time in configuration and to aid with plant diagnostics.

Specialist function blocks

The 3500 supports a comprehensive range of function blocks to provide solutions with simple configuration.

- Setpoint programmer for time based profiles – ideal for furnaces and test chambers
- Zirconia input for carbon potential control
- Wet/dry humidity measurement
- Transducer scaling – load cells, melt pressure etc
- Maths, logic and timer functions

A system product

The 3500 is ideal for use in systems with flexible communication options to suit the architecture and integrate with other products. Its functionality with maths, logic and timers could also negate the need for a small PLC – saving money, time and space in the system.

Setpoint programming

An impressive Ramp/Soak programmer is available in the 3500. The ability to store up to 50 different programs, each with dual channel capability makes its ideal for applications such as heat treatment furnaces, autoclaves and environmental chambers – where often more than one variable needs to be profiled. The 3500 has functionality not normally found in a product of this class and its flexibility in being able to interact with other function blocks makes it a very powerful device.

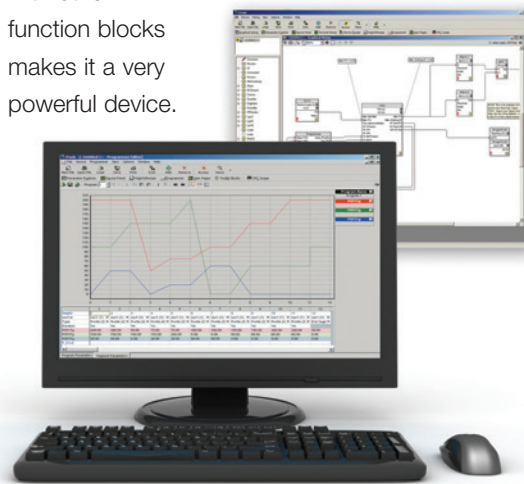

I/O expander

The I/O expander provides increased programmer functionality by increasing the digital I/O capability and expands the 3500 logic capacity by up to 40 I/O.

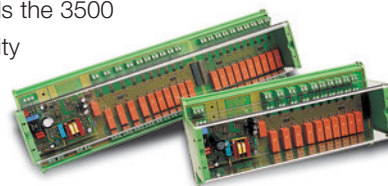

Feature packed

- 2 PID Loops
- SP Programs
- Maths Timers
- Fieldbus Comms
- Carbon
- Humidity
- Custom HMI

Real-world applications

Whether it's for excellence in control, ease of use or its flexible and creative solutions, the 3000 Series can be used in many applications to solve problems and save time and money.



Recipes

The 3000 recipe function is unique in a controller of this class. Recipes can be stored under a user-defined name to recall a number of parameter settings. These settings may include operating variables or configuration parameters, providing a very powerful means of altering the set up of a controller in a single operation. Recipes may be recalled either from the HMI, over the communications link, or using digital inputs.

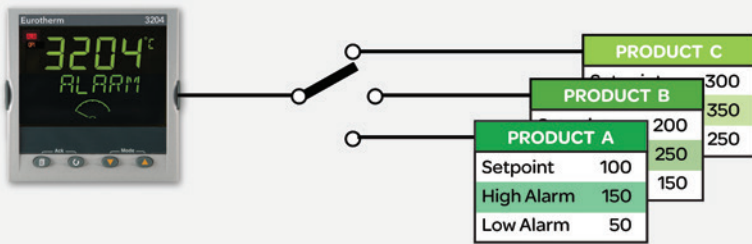

Timer

The simple timer in the 3200 may be used to control batch operations, eg. food ovens, sterilisers, fryers. Ideal for any application requiring a single dwell at the end of either a controlled ramp or natural approach to setpoint without the need for an additional timing device.

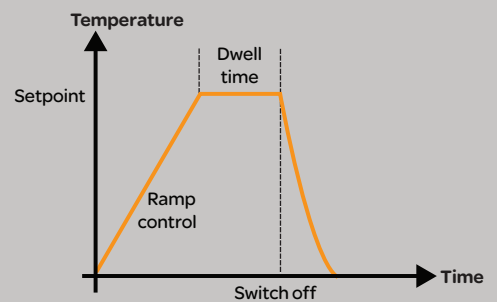

Feedforward

Feedforward is a control technique used to compensate for future disturbances or process changes. It provides an offset on the controller PID calculation to ensure that corrective action is taken to prevent the measured PV being disturbed. A typical application is additive dosing. By measuring the flow rate upstream from the dosing pump it is possible to use the feedforward feature of the 3500 to achieve an output proportional to the fluid flow rate. This means that the dosing rate immediately tracks any changes in flow rate and so prevents any possibility of dangerous over dosing.

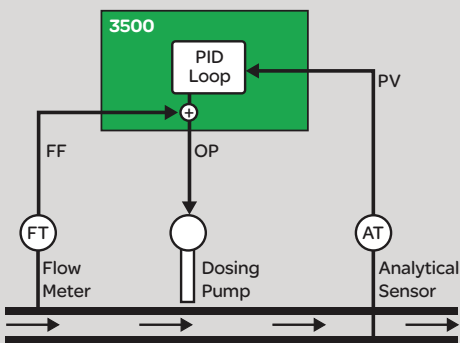

Heater failure detection

A current transformer input in the 3200 measures the current switched through the load. The measurement is filtered so that the on current and off currents can be separated. From this it is possible to diagnose several load faults including partial load failure, over current and an SSR fault. Typical applications include plastic extrusion, laboratory ovens and other applications where early indication of heater failure can save energy and rework costs.

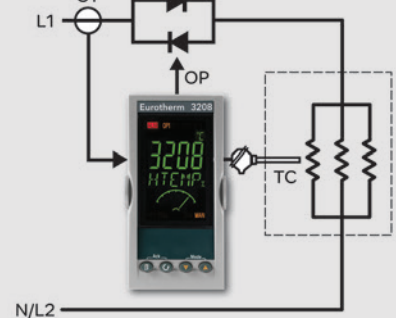

Programmer

Many applications need to vary temperature, or other process values, with time. The setpoint is varied by using a setpoint program. The program is stored as a series of 'ramp' and 'dwell' segments. All 3000 Series controllers provide this feature. The 3200 has an extremely easy to use 8 segment programmer for simple applications while the 3500 has a very flexible dual channel programmer with storage for 50 programs. The 3500 is ideal for furnace, environmental chamber and autoclave applications that require greater flexibility.

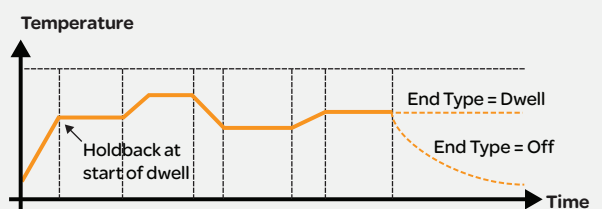

Dual loop

The Dual Loop capability in the 3500 makes it ideal for controlling interactive processes such as those found in carburising furnaces, environmental chambers, autoclaves and fermenters. All of these applications require control and often setpoint programming of two variables. By using the advanced maths and logic functions within the 3500, intelligent control strategies can be created to compensate for interactive effects between variables and maintain them at setpoint.

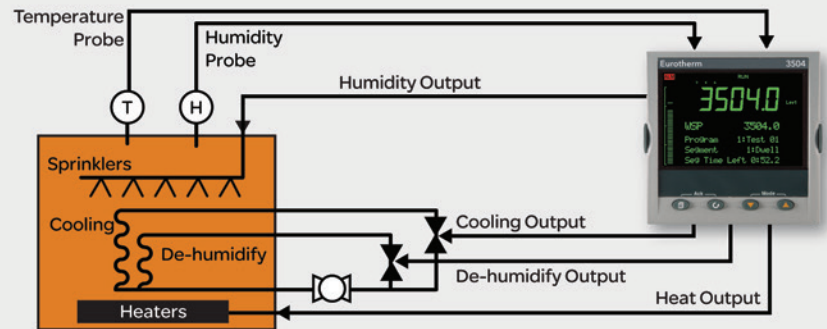

Messages

The HMI on 3000 Series controllers are customisable to show plant information in the format that is most useful for the operator. Customisable scrolling text can indicate event and alarm conditions, to trigger another function, or instruct an operator of the current state of the process. The 3500 has additional facilities to enable a user to design their own user interface.



Zirconia

The zirconia block calculates carbon potential, oxygen concentration and dew point based on the temperature and probe mV measurements from a zirconia oxygen probe. Probe burn-off sequence and diagnostic alarms are also available to help extend the life of the probe and predict impending probe failure while minimising downtime and rework. This feature enables the 3500 to be used to control carbon potential in an atmosphere furnace, an inert atmosphere in a sintering furnace and dewpoint in an endothermic generator.

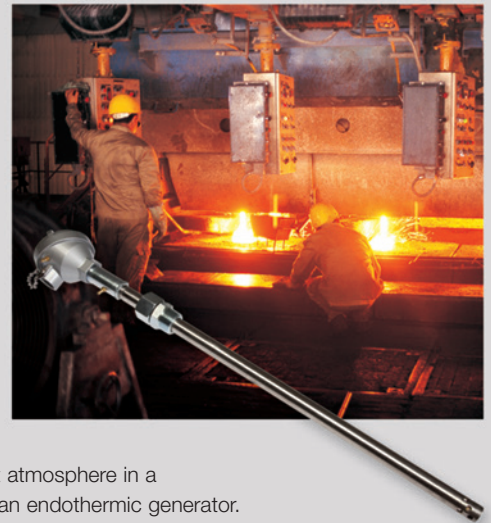

Transducer scaling

User calibration can be performed in all 3000 Series controllers.

The 3200 provides a simple two point calibration on its input and the 3500 has a comprehensive set of transducer scaling options that make it ideal for melt pressure, load cell or comparison type calibrations.

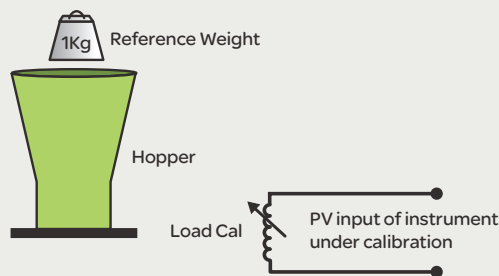

Master comms

In all 3000 Series controllers it is possible to use the Modbus RTU communication link to send a value (often setpoint) from one controller to a network of slave devices - providing the economical creation of multi-zone temperature control solutions

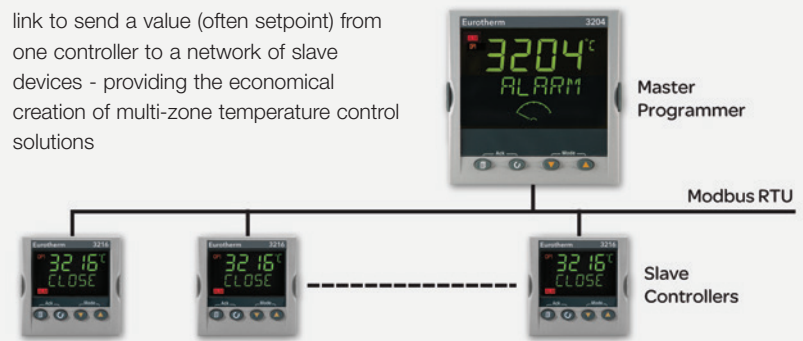

Dual valve positioning

The Dual Valve Positioning (VP) feature on the 3500 allows two motorised valves to be modulated from one controller. Typically one valve would actuate a burner or hot air inlet and the other a cooling damper. This feature removes the need to interface the controller via external positioners.

The VP feature can be used with or without a feedback potentiometer and can also be used with PID in either control channel to provide control strategies such as PID Heat/VP Cool.

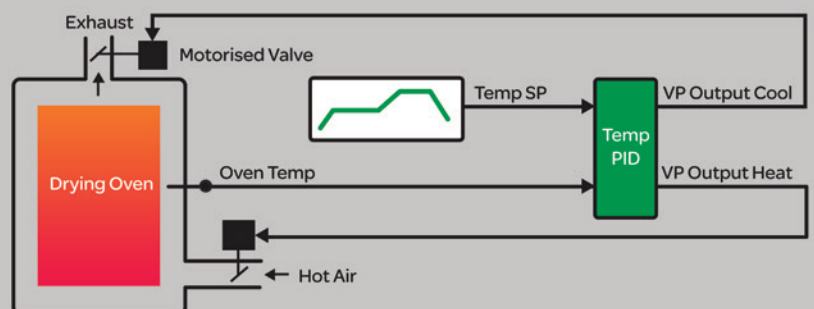

Success stories commercial benefits

CASE STUDY Accurate and Reliable when it matters most

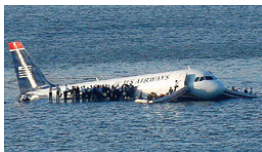

US Airways Flight 1549 - the most successful ditching in aviation history. Our customer provided the aviation tension springs inside the Ram Air Turbine (RAT). **We ensured the process control for their high tolerance springs production was accurate reliable and traceable.**

The RAT was deployed when both engines failed after striking a flock of Canada Geese shortly after take off. The RAT provided the hydraulic power for the pilot to manoeuvre the aircraft into position for a water landing in the Hudson River-subsequently known as the most successful ditching in aviation history.

Customer Challenge

Vital that production is entirely accurate predictable and traceable so the precision high tolerated springs manufactured are robust, reliable and therefore, predictable.

Solution

- 3504 advanced Temperature/Process Controller for precision Temperature Control
- AeroDAQ AMS2750E Data Management Solution for data acquisition and thermocouple monitoring

Customer Benefits

- Flexible control and measurement of multitude of variables
- True Out of the Box operation with QuickStart code
- Clear user based display
- Security of intellectual property gives peace of mind

CASE STUDY Protecting expensive injection molding equipment for years to come



The 3216 temperature controller has been successfully implemented as a Chiller controller in the USA plastic market

Customer Challenge

Our injection molding customer needed long term protection for their new process molding machinery while aiding consistent production. They wanted consolidated control over multiple chillers.

Solution

- The 3216 controller regulates the chiller's functions. The chiller will provide stable temperature, flow and pressure

Customer Benefits

Stable temperature flow and pressure means

- Protection of expensive plant machinery 24 hours a day 7 days a week for years and years to come
- Increased production
- Reduces rejected parts while increasing the number of parts produced per hour
- The 3216 controller replaces several interconnected devices to chillers
- The level of functionality, programmability and alarming allows the user to create a local custom alarm strategy for optimum operating safety
- This minimizes downtime and improves quality

CASE STUDY Life, the Universe and everything...

This is a cryostat built at the facility. It enables researchers to subject materials for microscopic study to extremely low temperatures - thermodynamic conditions - in order to study their structure and dynamics using neutron beams. Eurotherm 3504 controller monitors the liquids nitrogen and helium levels that are used to control the cryostat.

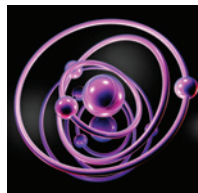

Accurate control and monitoring of Liquid Cryogen is vital in advanced Neutron science and the Eurotherm 3504 controller is the preferred choice at a world renowned research facility, combining expert measurement and control with a comprehensive and clear user interface.

At the facility, neutron beams can be tailored to probe the fundamental processes that help to explain how our universe came into being, why it looks the way it does today and how it can sustain life.

Customer Challenge

Within the institute, one of the services for advanced neutron science research; chose Eurotherm to resolve the issues of a particular type of instrument that kept breaking down, a liquid cryogen Level Monitor.

Solution

- 3504 Advanced temperature controller. Our solution accurately monitors levels of liquid Helium and Nitrogen and cold valve controllers.







Customer Benefits

- Ideal for demanding, high accuracy applications due to its precision control of melt pressure and other key variables
- It is a highly flexible solution with interconnectivity, and a totally customisable display
- Very tough and durable
- Best ongoing technical support for any issues in the future

Further information on how our products are being used by Services for Advanced Neutron Environment (SANE) can be seen at the links to the institute's website Nitrogen Level Monitors Helium Level Monitors Control Valve Monitors

For the full stories and all our successes go to www.eurotherm.com/success

Selection guide

Single Loop	3200 Series				3500 Series	
						
FEATURES	3216	3208	32h8	3204	3508	3504
Panel size (DIN)	1/16	1/8	1/8	1/4	1/8	1/4
IP Rating	IP65, NEMA12				IP65, NEMA12	
Display Type	Main: 4 digits Lower: 5 character starburst (3216/08/04) 9 character starburst (32h8)				Main PV: 5 digit plus 4 line alphanumeric	
Supply Voltage	24V dc/ac 85-264V ac				24V dc/ac, 85-264V ac	
Safety Approvals	EN14597 TR, CCC Exempt				✗	
Input Type	TC, RTD,mV, mA, CT				TC, RTD, mV, mA, Volts	
PV Accuracy	<0.25%				<0.1%	
Control Types	On/Off, PID, VP				On/Off, PID, VP	
Special Features	Recipes, Text messaging				User wiring, Master comms	
SP Programmer	4 Ramp + 4 Dwell				50 Programmes, 500 Segments max	
Analogue IP/OP	In: 2 Out: 3				In: 5 Out: 6	
Digital IP/OP	In: 3 Out: 4				In: 40 Out: 41	
Digital Comms	Modbus				Modbus, DeviceNet, Profibus, Ethernet	
Maths Equation	✗				24 Calculations	
Combinational Logic	✗				24 Operations	
Timers/Counters/Totals	✗				4 / 2 / 2	
Real Time Clock	✗				Day and Time	
Alarm Types	Hi, Lo, Dev, Heater fail Sensor break, Event				Hi, Lo, Dev, Heater fail Sensor break, Event	
PC Configuration	Wizard				Graphical Wiring	



Eurotherm Limited

Faraday Close, Durrington,
Worthing, West Sussex, BN13 3PL
Phone: +44 (01903) 268500
Fax: +44 (01903) 265982
www.eurotherm.com/worldwide



Scan for local
contacts

Eurotherm by Schneider Electric, the Eurotherm logo, Chessell, EurothermSuite, Mini8, Eycon, Eyris, EPower, EPack, nanodac, piccolo, versadac, optivis, Foxboro and Wonderware are trademarks of Schneider Electric, its subsidiaries and affiliates. All other brands may be trademarks of their respective owners.

All rights are strictly reserved. No part of this document may be reproduced, modified, or transmitted in any form by any means, nor may it be stored in a retrieval system other than for the purpose to act as an aid in operating the equipment to which the document relates, without the prior written permission of Eurotherm Limited.

Eurotherm Limited pursues a policy of continuous development and product improvement. The specifications in this document may therefore be changed without notice. The information in this document is given in good faith, but is intended for guidance only.

Eurotherm Limited will accept no responsibility for any losses arising from errors in this document.

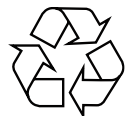

**INVESTORS
IN PEOPLE**