

3500 lm DC Flood Light Data Sheet

FD Series



IP66



P/N	FD035X-121*	FD035X-241*	FD035X-481*
Picture			
Rated Lumen**	3500 lm		
Rated Voltage	9~18 VDC	18~32 VDC	42~56 VDC
Power Factor	>0.9		
Lighting Efficacy**	140 lm/W		
Rated Power	25W		
Color Temp	5000K / 3000K		
CRI	>80, R9>0		
Beam Angle	110°		
Central lux@5000K (1M/2M/3M)	1430Lx/358Lx/158Lx		
Dimension(±2mm)	203mm(L) x 176mm(W) x 64mm(H)		
Weight(±5%)	1260g		

* X Can be replaced by C:5000K/ W:3000K.

**The value is measured at 5000K.



Content

1. Introduction	3
2. Features	3
3. Application	3
4. Dimensions	4
5. Photometry	4
6. Operation Condition	5
7. Specification	5
8. Packaging	6
9. Wiring Instruction	6
10. Installation Instruction	7
11. Out-Door Wiring for Water-Proof	8
12. Warranty	9



Introduction

【 FD035 】 3500Lm LED Out-Door DC Floodlight is a revolutionary product, its higher efficacy (140Lm/W) and powered by Meanwell(LDD/LDH) provides a better energy saving solution, longer product life time, and good stability(IP66) in out-door environment.

Features

1. Use fin-structure aluminum housing for excellent thermal dissipation and light weight.
2. Using high efficacy LED module to perform 140 steady lighting lumen per wattage.
3. Higher color rendering, CRI>80 with R9>0
4. Breather embedded to avoid glass fogging.
5. IP66 waterproof level.
6. Testing report ready by TAF lab (IP66 and light density distribution for 5000K)
7. Easy to install.
8. Meet RoHS standard.

Application

1. Outdoor lighting applies to solar powered facilities
2. Outdoor equipment or vehicle lighting
3. Outdoor lighting for the place which supplies DC power



Dimension

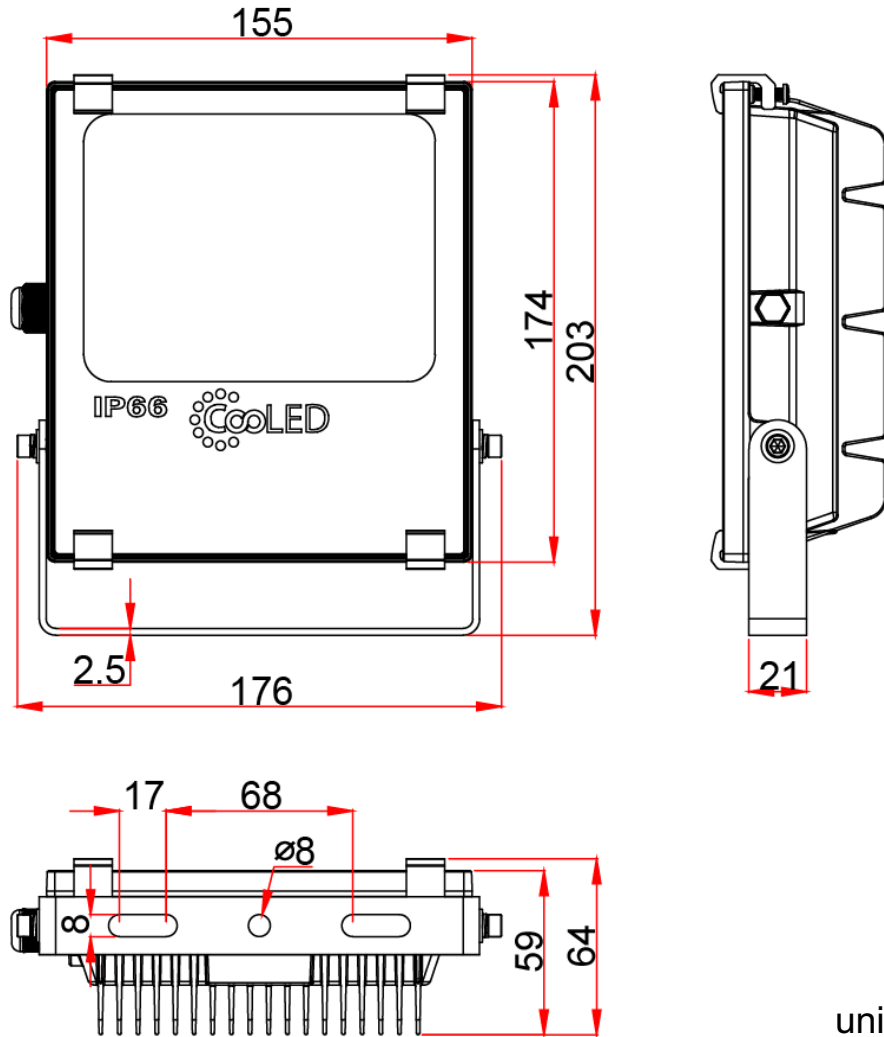

unit : mm

Photometry

Central Lux@5000K

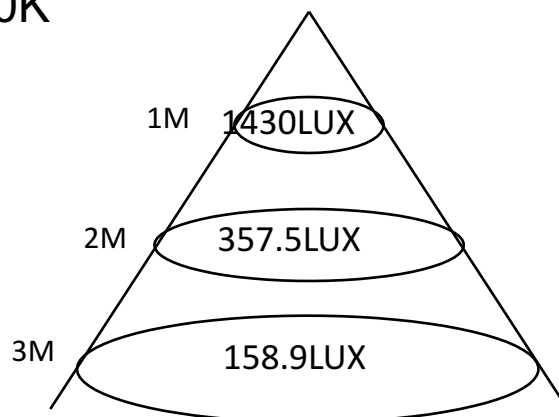

Operation Condition

Input voltage : 9~18 VDC (XX1=121)

18~32 VDC (XX1=241)

42~56 VDC (XX1=481)

Operation ambient temperature : -30°C to +40 °C

Storage temperature Range : -40°C to +60 °C

Specification

Parameter	Rating	Unit
DC Input Voltage	9~18 / 18~32 / 42~56	VDC
Operation Ambient Temperature	-30 to+40	°C
Color Temperature	5000 / 3000	K
Rated Lumen	3500	lm
Lighting Efficacy	140	lm/W
CRI	>80,R9>0	
Dimension(±2mm)	203 x 176 x 64	mm
Weight(±5%)	1260	g
Lifetime	40000	hr
Beam Angle	110	degree

- Notes:**
1. Luminous flux is measured at 5000K and with an accuracy of ±10%.
 2. Luminous flux is measured at TA= 25°C and reaches thermal equilibrium.
 3. Power unit inside.



Packaging

23.5(L)*18 (W) *7(H) / box

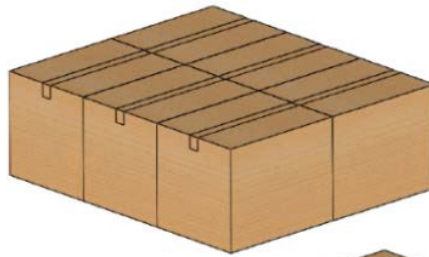
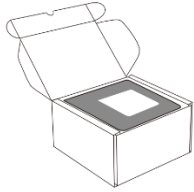

1 layer= 6 cartons= 120 ea

Total 5 layers

1 pallet= 600 ea FD035X-XX1

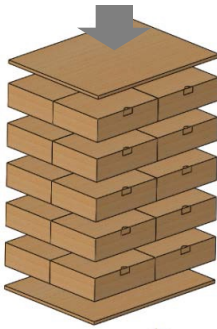

48(L)*37(W) *38(H) / carton= 20ea

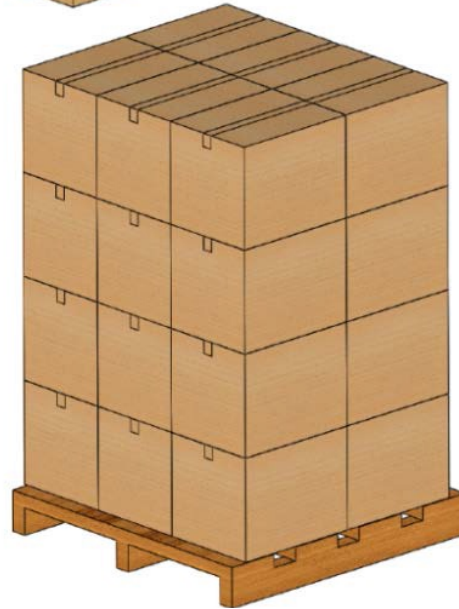

Pallet dimension: 110*110*13

unit: cm

Wiring Instruction

Brown	DC+
Blue	DC-
Yellow/Green	Ground

DC Input : 9~18 VDC (-121)
18~32 VDC (-241)
42~56 VDC (-481)

DC +
DC -
GND

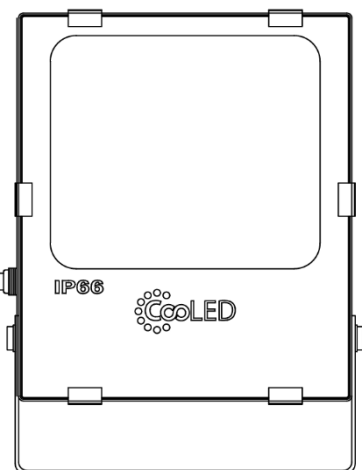









Note: Standard length of power wire is 30cm and without connector.
Extension power wire or connector can be purchased optionally.

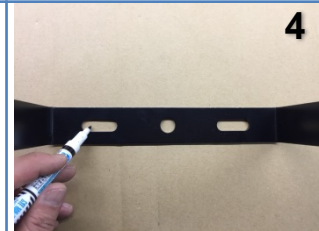

Installation Instruction

Caution:

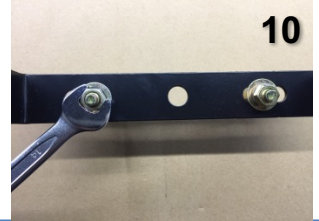
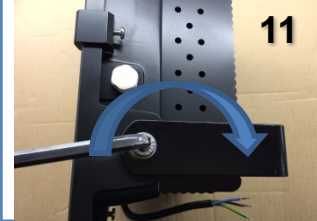
1. Read the instruction carefully before installation.
2. Make sure the power is off before installation.
3. Make sure structure is strong enough for drilling process before installation
4. Make sure no high power-consumption equipments nearby the lamp (e.g., elevator, refrigerator, air-conditioner). It will generate surge that may damage the lamp while start up.
5. Non-professional staff shall not use any tools to disassemble or repair lamps.
6. The screw sizes of each lamps are different. Please select correct size of hexagon key for installation.

			
<p>Unscrew the bracket screw by hexagon key in a counterclockwise direction.</p>	<p>Remove both sides of screws.</p>	<p>Remove the bracket and keep the related accessories carefully.</p>	<p>Put the bracket on the structure and mark the oval-hole shapes on the structure.</p>
			
<p>Finish the mark process.</p>	<p>Drill two holes at the center of the marks by electric drill.</p>	<p>Take 2 sets of anchoring screws(prepared by installer)</p>	<p>Knock anchoring screws into the holes of structure by hammer.</p>
			
<p>Remove the nuts and washers of anchoring screws.</p>	<p>Fit the bracket through the anchoring screws. Put washer and nut by sequence and screw it by wrench.</p>	<p>Align the holes of bracket with the holes of lamp, then screw it firmly by hexagon key in a clockwise direction.</p>	<p>Make sure lamp and bracket installed firmly.</p>

Note: 1. Make sure the power is off before installation. Then do wiring process after installation.

2. Make sure the screws are firm after installation. Please change the position and repeat step 4-8 once the holes of structure are loose.







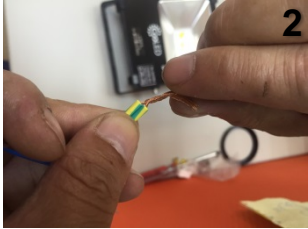
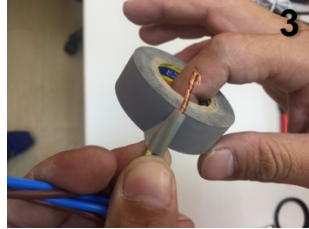
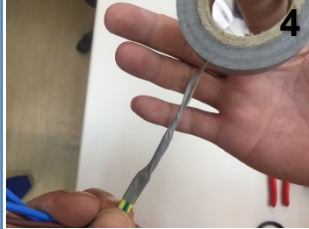
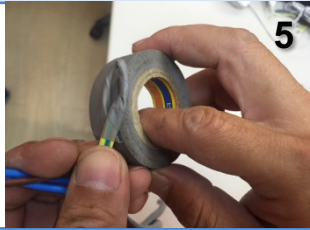

Out-Door Wiring for Water-Proof

Caution:

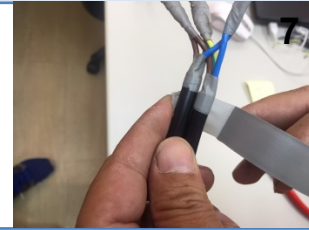
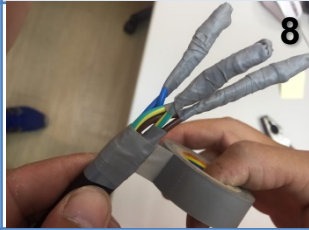
1. Read the instruction carefully before wiring.
2. Make sure the power is off before installation.
3. Make sure no high power-consumption equipments nearby the lamp (e.g., elevator, refrigerator, air-conditioner). It will generate surge that may damage the lamp while start up.
4. Non-professional staff shall not use any tools to disassemble or repair lamps.
5. Make sure DC input voltage of lamp(9~18/18~32/42~56) when purchasing. Connect DC (+) of lamp to positive (+) side of DC power and DC (-) of lamp to negative (-) side of DC power.

WARNING: Lamp will be burned out if wrong wiring.

 <p>1</p>	 <p>2</p>	 <p>3</p>	 <p>4</p>
<p>Tie the 3-core cable of lamp by insulation tape to cover all branch area for water-proof. Same as the cable of DC side.</p>	<p>Twist bare wires of lamp ground cord and DC ground cord together at the same direction. Same as DC positive (+) cords and DC negative (-) cords.</p>	<p>Fold up the front end of bare wires to prevent tape falling off. Then cover it by insulation tape.</p>	<p>Continue winding bare wires by tape. It should be over the front end of bare wires 4 to 8 cm.</p>
 <p>5</p>	 <p>6</p>	 <p>7</p>	 <p>8</p>
<p>Pull the surplus tape back to prevent bare area from getting vapor.</p>	<p>Repeat step 4 and 5 at least 3 times. Refer to Electrical Engineering Rules about winding methods and standards.</p>	<p>Make sure 3 groups of wires are covered by tape firmly, then start to wind the tape from the branch point of two main cords.</p>	<p>Keep winding the tape and ensure two main cords covered by tape firmly.</p>
 <p>9</p>	 <p>10</p>	 <p>11</p>	 <p>12</p>
<p>Continue winding 3 groups of wires by tape. It should be over the front end of bare wires 10 to 15 cm.</p>	<p>Pull the surplus tape back to prevent bare area from getting vapor.</p>	<p>Repeat step 8 and 9 at least 3 times. Refer to Electrical Engineering Rules about winding methods and standards.</p>	<p>Fold up the cords with tape and face up. The cord position has to lower than lamp, or vapor will follow the cords into the lamp when it rains.</p>

Note: Turn off the power before installation. Turn on the power after make sure the positive and negative polarity are correct and match with input power.



Warranty

We offer **two-year limited warranty** on the entire system.

1. Under normal condition with no mechanical damage or LED light module disassembly, LED lumen degradation is within 30%. (Under the environment of room temperature 25°C, the LED life maybe more than 50000 hr)
2. Warranty does not provide coverage for product damage resulting from the end user's failure to replace surge protection devices before they have reached their useful life.
3. Warranty does not provide coverage for product damage resulting from the natural disasters like typhoon, flood etc.
4. CoolLED is not responsible for the product which is transformed or dismantled without permission.

We reserve the right to modify, and/or to withdraw any part of data sheet herein.

