

## 3600 Im Flood Light Data Sheet

*F2 Series*



IP66



P/N	F2036X-001*	F2070X-001*	F2140X-001*
Picture			
Rated Lumen**	3600 Im (Measured value:3694.2 Im)	7000 Im (Measured value:6960.3 Im)	14000 Im (Measured value:14156.3 Im)
Rated Voltage	100~240V, 50/60Hz		
Power Factor	>0.9		
Lighting Efficacy**	112 lm/W	114.9 lm/W	119.3 lm/W
Rated Power	33W	60W	120W
Color Temp	6500K / 3000K		
CRI	>80, R9>0		
Beam Angle	110°		
Central lux@6500K (1M/2M/3M)	1395Lx/349Lx/155Lx	2612Lx/653Lx/290Lx	5374Lx/1344Lx/597Lx
Dimension(±2mm)	227mm(L) x 188mm(W) x 40mm(H)	310mm(L) x 245mm(W) x 50mm(H)	402mm(L) x 325mm(W) x 60mm(H)
Weight(±5%)	830g	1530g	4050g

\* X Can be replaced by C:6500K/ W:3000K.

\*\*The value is measured at 6500K.



---

# Content

---

<b>1 · Introduction</b>	<b>3</b>
<b>2 · Features</b>	<b>3</b>
<b>3 · Application</b>	<b>3</b>
<b>4 · Dimensions</b>	<b>4</b>
<b>5 · Photometry</b>	<b>4</b>
<b>6 · Operation Condition</b>	<b>6</b>
<b>7 · Specification</b>	<b>6</b>
<b>8 · Packing</b>	<b>7</b>
<b>9. Wiring Instruction</b>	<b>7</b>
<b>10. Installation Instruction</b>	<b>8</b>
<b>11. Out-Door Wiring for Water-Proof</b>	<b>9</b>
<b>12. Warranty</b>	<b>10</b>



---

# Introduction

---

【 F2036 】 3600Lm LED Out-Door Floodlight is a revolutionary product, its higher efficacy (110Lm/W) provides a better energy saving solution, longer product life time, and good stability(IP66) in out-door environment.

---

## Features

---

1. Use fin-structure aluminum housing for excellent thermal dissipation and light weight.
2. Using high efficacy LED module to perform 110 steady lighting lumen per wattage.
3. Higher color rendering, CRI>80 with R9>0
4. Breather embedded to avoid glass fogging.
5. IP66 waterproof level.
6. Testing report ready by TAF lab (IP66 and light density distribution for 6500K)
7. Easy to install.
8. Meet RoHS standard.

---

## Application

---

1. Landscape lighting
2. Decorative lighting
3. Billboard, parking lot, factory, school, hospital etc.
4. Other outdoor lighting



# Dimension

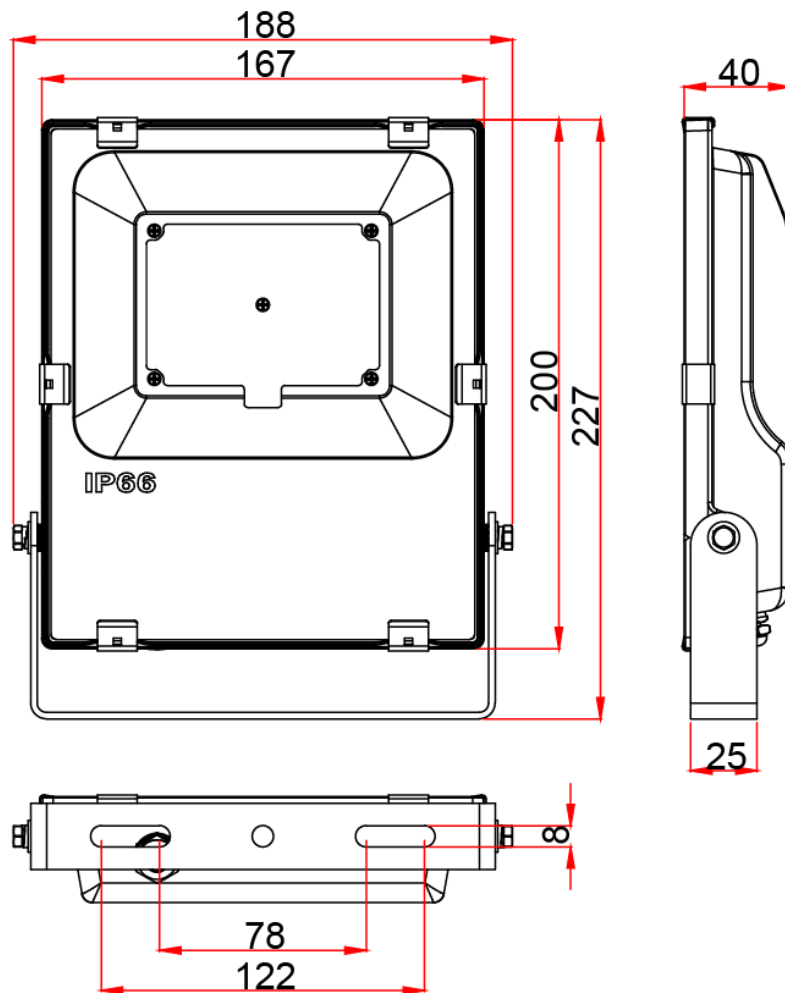

unit : mm

# Photometry

Central Lux@6500K

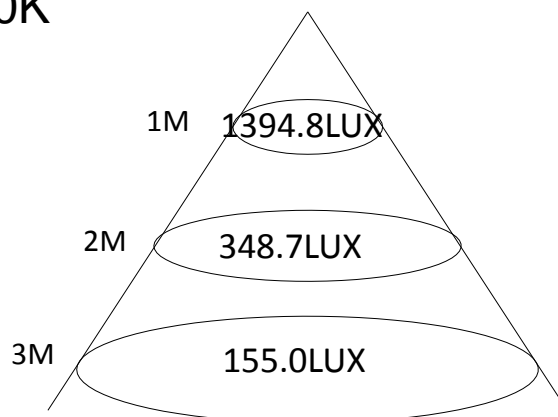

# Photometry

## F2036C-001 @220V

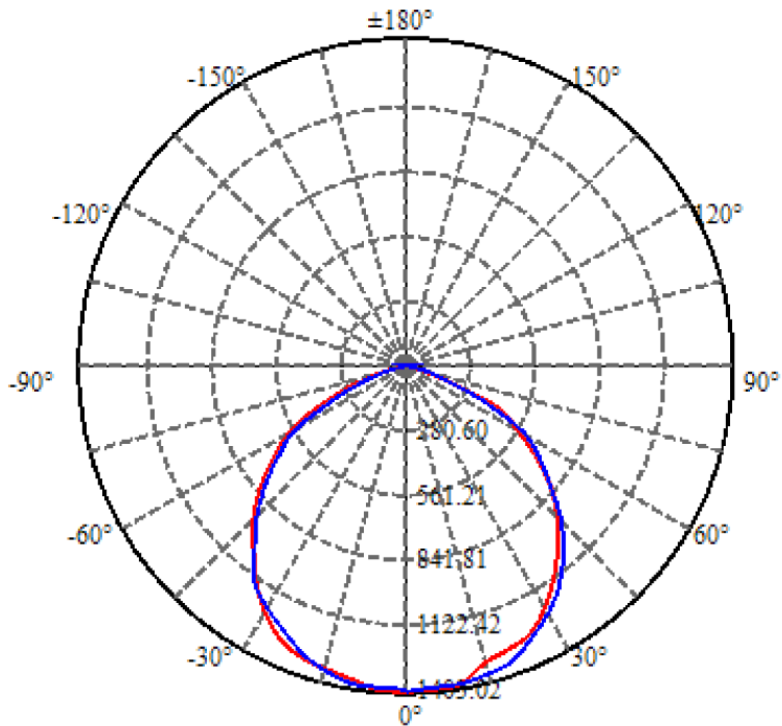

Isocandela diagram

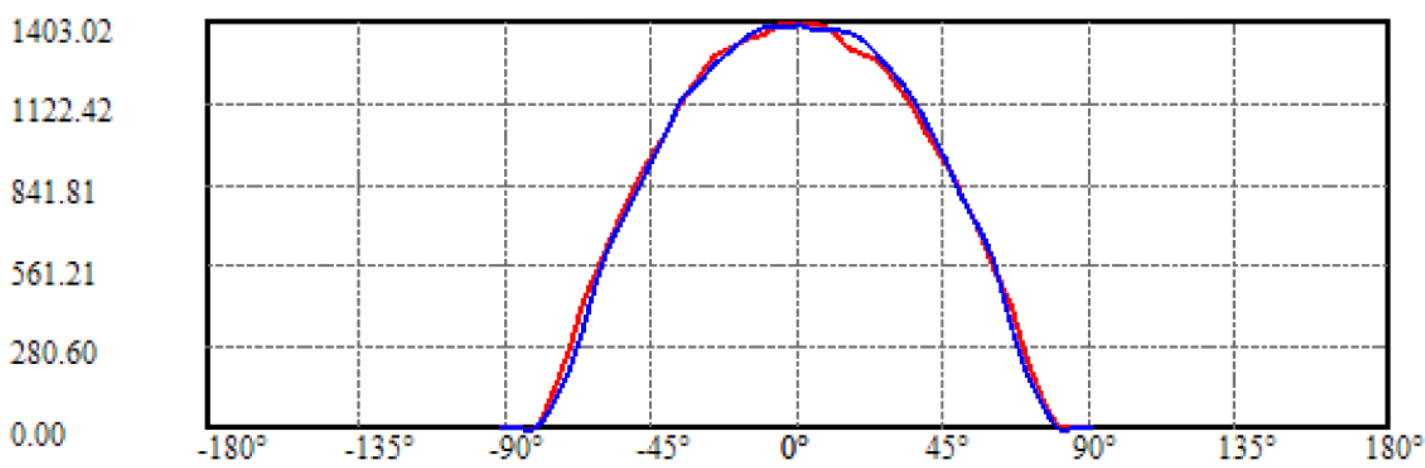
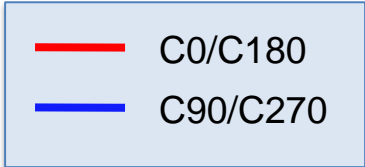

Cartesian coordinates



# Operation Condition

Input voltage : 100~240VAC, 50/60Hz

Operation ambient temperature : -30°C to +40 °C

Storage temperature Range : -40°C to +60 °C

# Specification

Parameter	Rating	Unit
AC Input Voltage	100~240	VAC
Frequency	50/60	Hz
Operation Ambient Temperature	-30 to+40	°C
Color Temperature	6500 / 3000	K
Rated Lumen	3600 (Measured value:3694.2 )	lm
Lighting Efficacy	112	lm/W
CRI	>80,R9>0	
Dimension(±2mm)	227 x 188 x 40	mm
Weight(±5%)	830	g
Lifetime	40000	hr
Beam Angle	110	degree

- Notes:**
1. Luminous flux is measured at 6500K and with an accuracy of ±10%.
  2. Luminous flux is measured at TA= 25°C and reaches thermal equilibrium.
  3. Power unit inside.



# Packing

26(L)\*19.5(W) \*4.5(H) / box

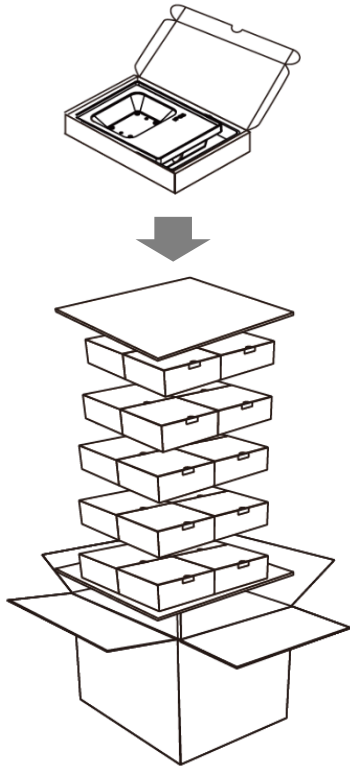

54(L)\*41(W)\*26(H) / carton = 20ea

1 layer = 4 cartons = 80 ea  
total 7 layers

1 pallet= 560 ea F2036X-001

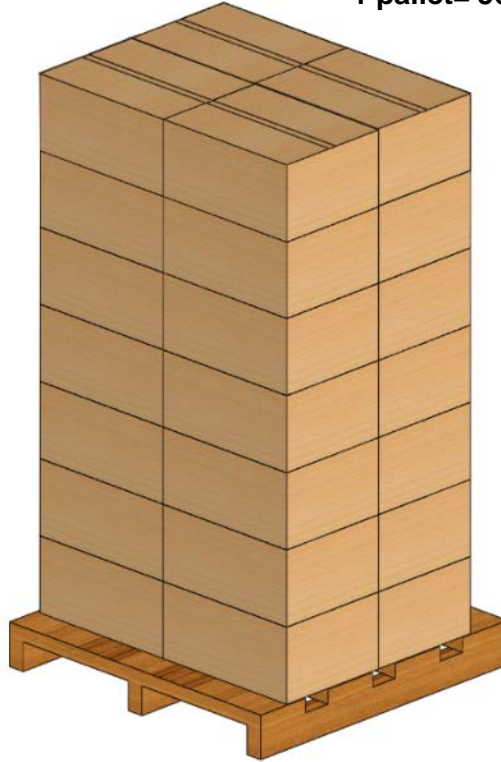

Pallet dimension: 110\*110\*13

Unit : cm

# Wiring Instruction

Brown	AC/L
Blue	AC/N
Yellow/Green	Ground

AC Input : 100~240V  
Frequency : 50/60 Hz

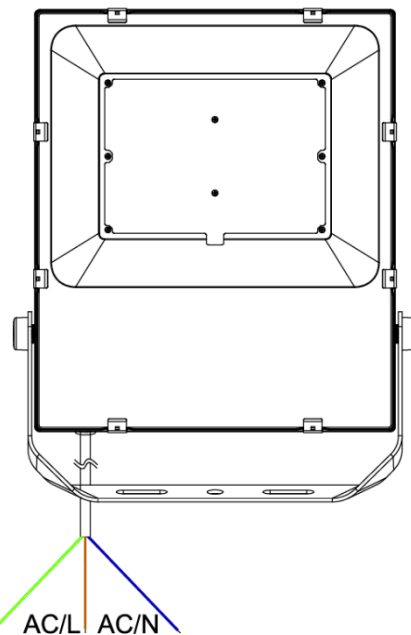

# Installation Instruction

## Caution:

1. Read the instruction carefully before installation.
2. Make sure the power is off before installation.
3. Make sure structure is strong enough for drilling process before installation.
4. Make sure no high power-consumption equipments nearby the lamp (e.g., elevator, refrigerator, air-conditioner). It will generate surge that may damage the lamp while start up.
5. Non-professional staff shall not use any tools to disassemble or repair lamps.
6. The screw sizes of each lamps are different. Please select correct size of wrench for installation.

			
<p>Unscrew the bracket screw by wrench in a counterclockwise direction.</p>	<p>Remove both sides of screws.</p>	<p>Remove the bracket and keep the related accessories carefully.</p>	<p>Put the bracket on the structure and mark the oval-hole shapes on the structure.</p>
			
<p>Finish the mark process.</p>	<p>Drill two holes at the center of the marks by electric drill.</p>	<p>Take 2 sets of anchoring screws(prepared by installer)</p>	<p>Knock anchoring screws into the holes of structure by hammer.</p>
			
<p>Remove the nuts and washers of anchoring screws.</p>	<p>Fit the bracket through the anchoring screws. Put washer and nut by sequence and screw it by wrench.</p>	<p>Align the holes of bracket with the holes of lamp, then screw it firmly by wrench in a clockwise direction.</p>	<p>Make sure lamp and bracket installed firmly.</p>

**Note: 1. Make sure the power is off before installation. Then do wiring process after installation.**

**2. Make sure the screws are firm after installation. Please change the position and repeat step 4-8 once the holes of structure are loose.**









# Out-Door Wiring for Water-Proof

## Caution:

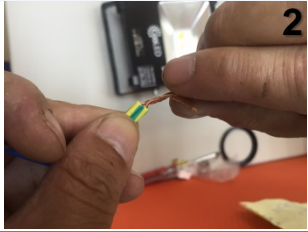
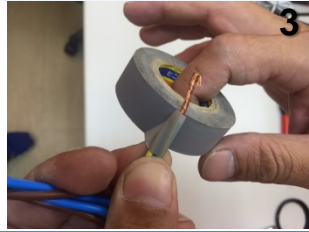
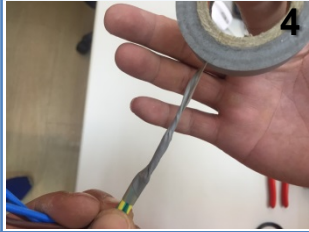
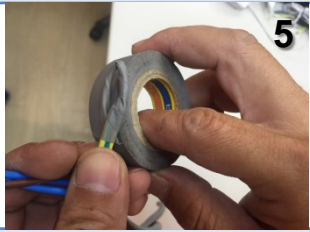
1. Read the instruction carefully before wiring.
2. Make sure the power is off before installation.
3. Make sure no high power-consumption equipments nearby the lamp (e.g., elevator, refrigerator, air-conditioner). It will generate surge that may damage the lamp while start up.
4. Non-professional staff shall not use any tools to disassemble or repair lamps.
5. Products are available for AC 100V~240V, 50/60Hz. DO NOT install lamp to the environment out of the range.

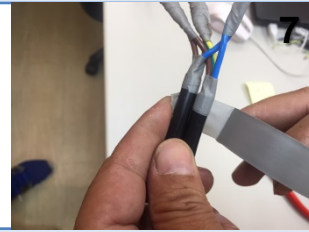
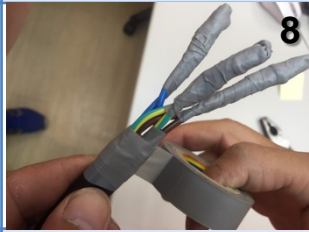
**Note: Emergency handling: Turn off the power when the lamp is abnormal.**

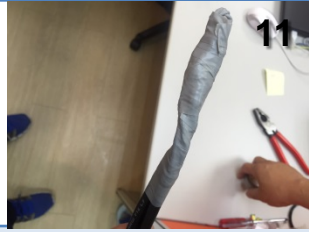
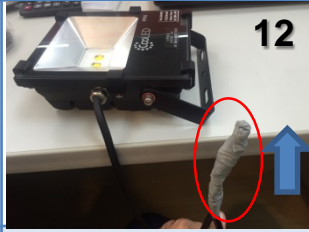
 <p>1</p>	 <p>2</p>	 <p>3</p>	 <p>4</p>
<p>Tie the 3-core cable of lamp by insulation tape to cover all branch area for water-proof. Same as the cable of AC side.</p>	<p>Twist bare wires of lamp ground cord and AC ground cord together at the same direction. Same as live cords(L) and neutral cords(N).</p>	<p>Fold up the front end of bare wires to prevent tape falling off. Then cover it by isolation tape.</p>	<p>Continue winding bare wires by tape. It should be over the front end of bare wires 4 to 8 cm.</p>
 <p>5</p>	 <p>6</p>	 <p>7</p>	 <p>8</p>
<p>Pull the surplus tape back to prevent bare area from getting vapor.</p>	<p>Repeat step 4 and 5 at least 3 times. Refer to Electrical Engineering Rules about winding methods and standards.</p>	<p>Make sure 3 groups of wires are covered by tape firmly, then start to wind the tape from the branch point of two main cords.</p>	<p>Keep winding the tape and ensure two main cords covered by tape firmly.</p>
 <p>9</p>	 <p>10</p>	 <p>11</p>	 <p>12</p>
<p>Continue winding 3 groups of wires by tape. It should be over the front end of bare wires 10 to 15 cm.</p>	<p>Pull the surplus tape back to prevent bare area from getting vapor.</p>	<p>Repeat step 8 and 9 at least 3 times. Refer to Electrical Engineering Rules about winding methods and standards.</p>	<p>Fold up the cords with tape and face up. The cord position has to lower than lamp, or vapor will follow the cords into the lamp when it rains.</p>

**Note: Turn off the power during wiring to prevent lamp damage because of abnormal wiring.**



# Warranty

---

We offer **two-year limited warranty** on the entire system.

1. Under normal condition with no mechanical damage or LED light module disassembly, LED lumen degradation is within 30%. (Under the environment of room temperature 25°C, the LED life maybe more than 50000 hr)
2. Warranty does not provide coverage for product damage resulting from the end user's failure to replace surge protection devices before they have reached their useful life.
3. Warranty does not provide coverage for product damage resulting from the natural disasters like typhoon, flood etc.
4. CoolLED is not responsible for the product which is transformed or dismantled without permission.

*We reserve the right to modify, and/or to withdraw any part of data sheet herein.*

