

SCHOOL DIGITAL AMPLIFIER

SA-60D-AS 1

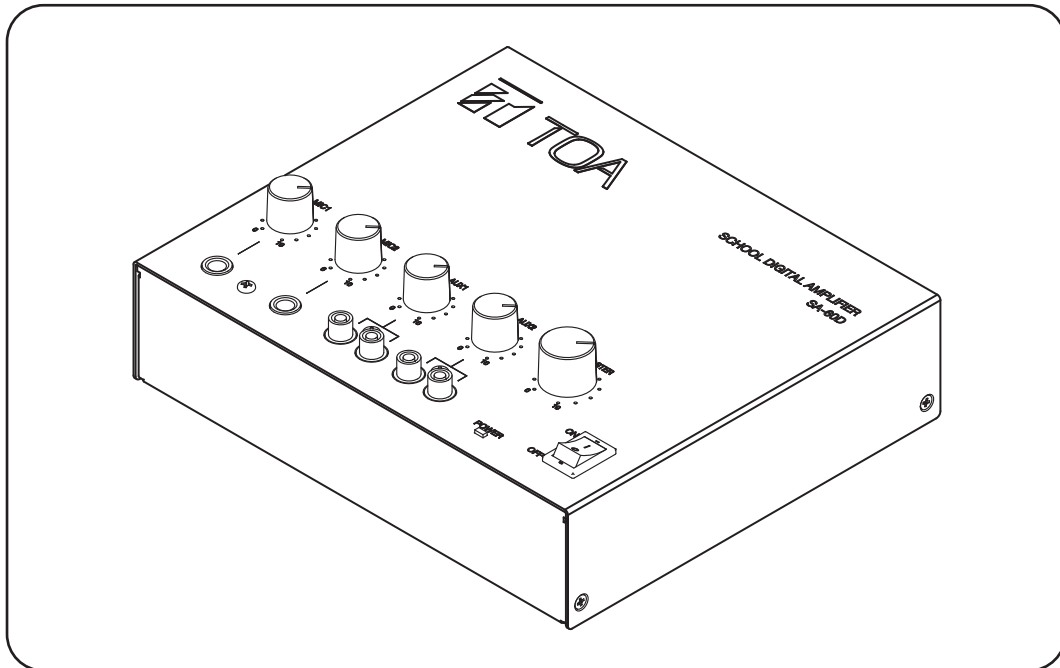

TABLE OF CONTENTS

1. SAFETY PRECAUTIONS	2	7. VOLUME CONTROL SETTINGS	6
2. GENERAL DESCRIPTION	4	8. DIMENSIONAL DIAGRAM	7
3. FEATURES	4	9. SPECIFICATIONS	7
4. NOMENCLATURE AND FUNCTIONS			
Top Panel	4		
Rear Panel	4		
5. INSTALLATION	5		
6. CONNECTION EXAMPLE	6		

Please follow the instructions in this manual to obtain the optimum results from this unit. We also recommend that you keep this manual handy for future reference.

1. SAFETY PRECAUTIONS

- Be sure to read the instructions in this section carefully before installation or use.
- Make sure to observe the instructions in this manual as the conventions of safety symbols and messages regarded as very important precautions are included.
- We also recommend you keep this instruction manual handy for future reference.

Safety Symbol and Message Conventions

Safety symbols and messages described below are used in this manual to prevent bodily injury and property damage which could result from mishandling. Before operating your product, read this manual first and understand the safety symbols and messages so you are thoroughly aware of the potential safety hazards.

 **WARNING**

Indicates a potentially hazardous situation which, if mishandled, could result in death or serious personal injury.

 **CAUTION**

Indicates a potentially hazardous situation which, if mishandled, could result in moderate or minor personal injury, and/or property damage.

 **WARNING**

■ When Installing the Unit

- Do not expose the unit to rain or an environment where it may be splashed by water or other liquids, as doing so may result in fire or electric shock.
- Use the unit only with the voltage specified on the unit. Using a voltage higher than that which is specified may result in fire or electric shock.
- Do not cut, kink, otherwise damage nor modify the power supply cord. In addition, avoid using the power cord in close proximity to heaters, and never place heavy objects -- including the unit itself -- on the power cord, as doing so may result in fire or electric shock.
- Avoid installing or mounting the unit in unstable locations, such as on a rickety table or a slanted surface. Doing so may result in the unit falling down and causing personal injury and/or property damage.
- Install the unit only in a location that can structurally support the weight of the unit. Doing otherwise may result in the unit falling down and causing personal injury and/or property damage.

■ When the Unit is in Use

- Should the following irregularity be found during use, immediately switch off the power, disconnect the power supply plug from the AC outlet and contact your nearest TOA dealer. Make no further attempt to operate the unit in this condition as this may cause fire or electric shock.
 - If you detect smoke or a strange smell coming from the unit.
 - If water or any metallic object gets into the unit
 - If the unit falls, or the unit case breaks
 - If the power supply cord is damaged (exposure of the core, disconnection, etc.)
 - If it is malfunctioning (no tone sounds.)
- To prevent a fire or electric shock, never open nor remove the unit case as there are high voltage components inside the unit. Refer all servicing to your nearest TOA dealer.
- Do not place cups, bowls, or other containers of liquid or metallic objects on top of the unit. If they accidentally spill into the unit, this may cause a fire or electric shock.
- Do not insert nor drop metallic objects or flammable materials in the ventilation slots of the unit's cover, as this may result in fire or electric shock.
- Do not touch the power supply plug during thunder and lightning, as this may result in electric shock.

⚠ CAUTION

■ When Installing the Unit

- Never plug in nor remove the power supply plug with wet hands, as doing so may cause electric shock.
- When unplugging the power supply cord, be sure to grasp the power supply plug; never pull on the cord itself. Operating the unit with a damaged power supply cord may cause a fire or electric shock.
- When moving the unit, be sure to remove its power. Supply cord from the wall outlet. Moving the unit with the power cord connected to the outlet may cause damage to the power cord, resulting in fire or electric shock. When removing the power cord, be sure to hold its plug to pull.
- Do not block the upper panel ventilation slots in the unit's cover. Doing so may cause heat to build up inside the unit and result in fire.
- Avoid installing the unit in humid or dusty locations, in locations exposed to the direct sunlight, near the heaters, or in locations generating sooty smoke or steam as doing otherwise may result in fire or electric shock.
- Keep the distance for all side of unit 5 cm (1.97") away from the object that may obstruct air flow for internal units temperature rise prevention, as show in the figure below.

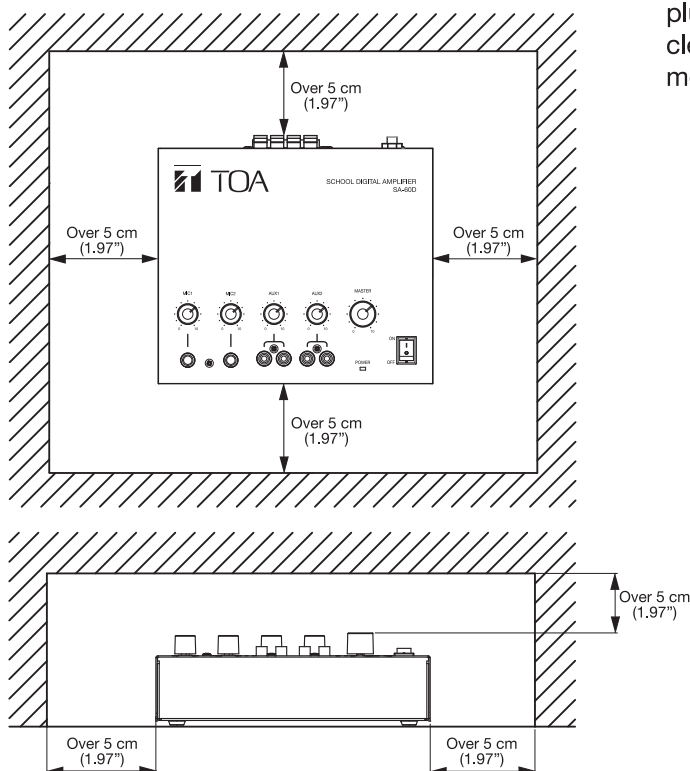

■ When the Unit is in Use

- Do not place heavy objects on the unit as this may cause it to fall or break which may result in personal injury and/or property damage. In addition, the object itself may fall off and cause injury and/or damage.
- Do not stand or sit on, nor hang down from the unit as this may cause it to fall down or drop, resulting in personal injury and/or property damage.
- Make sure that the volume control is set to minimum position before power is switched on. Loud noise produced at high volume when power is switched on can impair hearing.
- Do not operate the unit for an extended period of time with the sound distorting. This is an indication of a malfunction, which in turn can cause heat to generate and result in a fire.
- Contact your TOA dealer as to the cleaning. If dust is allowed to accumulate in the unit over a long period of time, a fire or damage to the unit may result.
- If dust accumulates on the power supply plug or in the wall AC outlet, a fire may result. Clean it periodically. In addition, insert the plug in the wall outlet securely.
- Switch off the power, and unplug the power supply plug from the AC outlet for safety purposes when cleaning or leaving the unit unused for 10 days or more. A fire or electric shock may result.

2. GENERAL DESCRIPTION

The SA-60D-AS 1 is a 60W Class-D amplifier suited for speech and background music used in classroom or training room in schools and offices. It is designed for both wall mount and desk-top installation.

3. FEATURES

- High durability, high reliability and high performance.
- Two microphone inputs and two AUX inputs.
- Cable wire push in terminal type for easy connection to speakers.
- Operates on AC power.
- Independent input volume control and master volume control.
- Excess current protection to prevent damage due to current overload.
- Excess heat protection to prevent damage due to overheat.

4. NOMENCLATURE AND FUNCTIONS

[Top Panel]

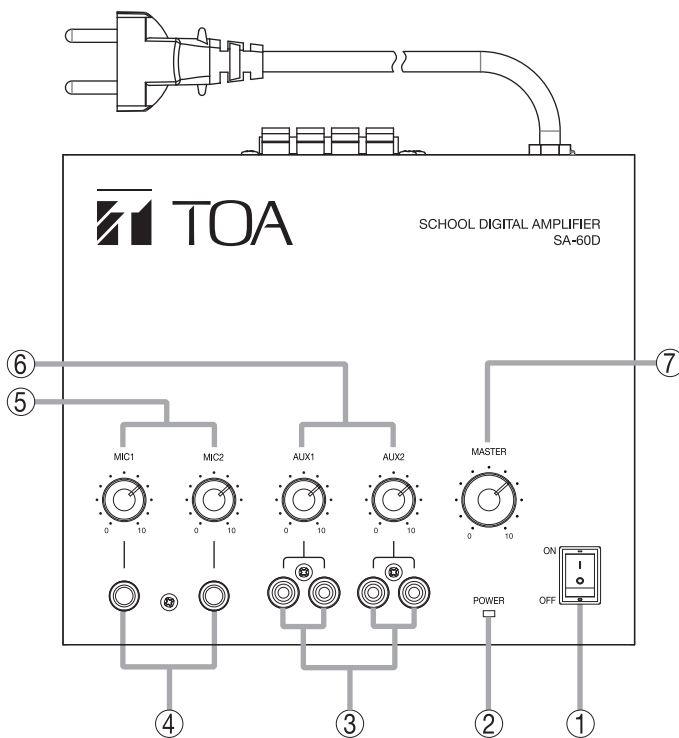

- ① **Power switch**
Setting this switch to the ON side to turn the power on. Setting it to the OFF side to turn the power off.
- ② **Power indicator lamp**
Lights blue when power is switched ON.
- ③ **AUX1 and AUX2 Input Terminals**
-20dBV, 10k Ω , unbalanced, monaural RCA pin jacks. Stereo input signals are converted into monaural signals.
- ④ **MIC1 and MIC2 Input Terminals**
-52dBV, 600 Ω , unbalanced, phone jack. Because microphone input is unbalanced type, use a single pole phone plug.

[Rear Panel]

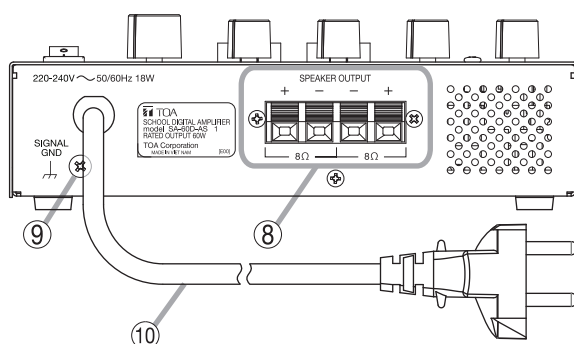

- ⑤ **MIC1 and MIC2 Volume Control**
Adjusts level of the microphone connected to microphone input ④ .
- ⑥ **AUX1 and AUX2 Volume Control**
Adjusts level of equipment connected to AUX input ③ .
- ⑦ **Master volume control**
Adjusts the overall signal level.
- ⑧ **Speaker Output Terminals**
Connects to speakers.
- ⑨ **Ground Terminal**
Connects to ground (earth) to avoid electric shock.
- ⑩ **AC Power Cord**
Connect to an AC power source.

5. INSTALLATION

- Connect the signal grounding terminal to the ground.
- Avoid installing the unit in humid, dusty or vibratory locations as well as locations where the unit is exposed to steam or oil-contaminated smoke.
- Do not block the vents on the side and rear. Allow a 50mm clearance between the unit.
- When mounting on the wall, fix securely as illustrated below.

Step1. Place the wall mounting pattern paper on the wall. Drill two guide holes on the wall 70 mm apart. Install two surface mount screws and leave approximate 7-10 mm from the wall surface.

Step2. Place the amplifier's hanging holes over the two installed screws to mount the amplifier to the wall surface.

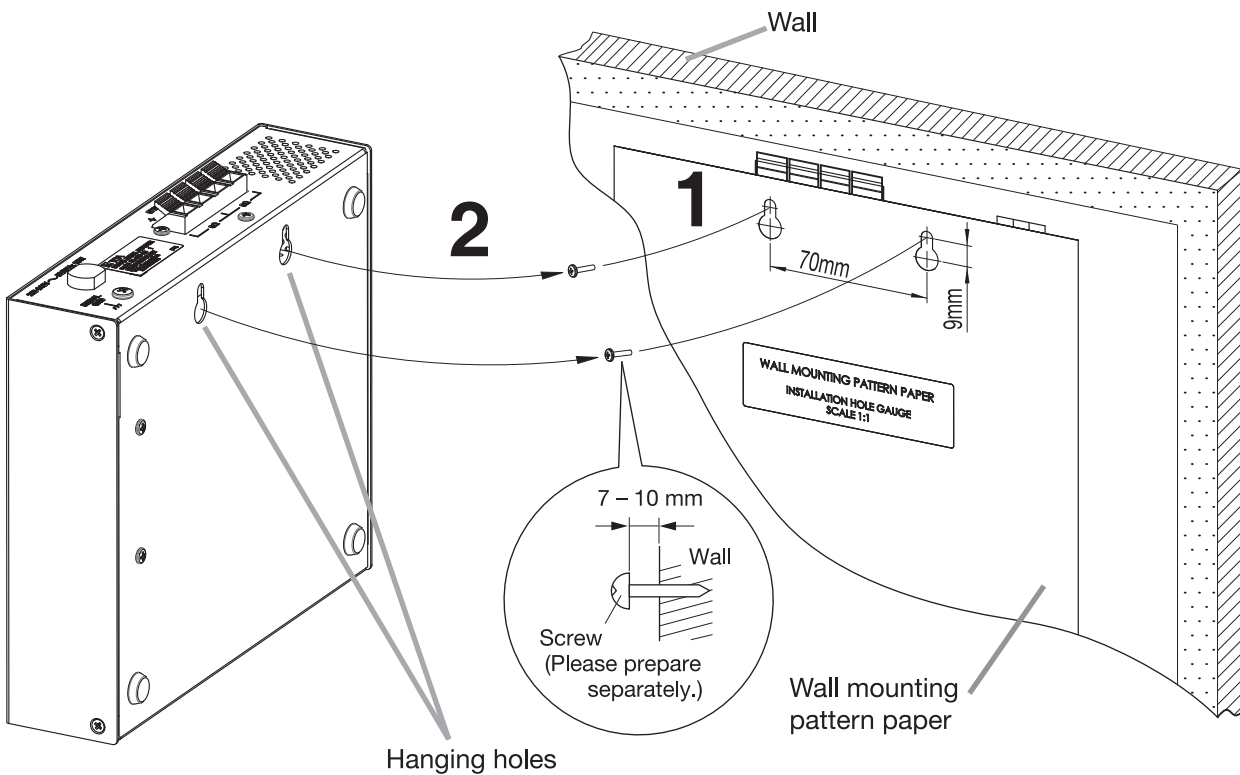

Note: The surface-mount screws are not supplied with the unit. Referring to the mounting hole's dimensional diagram below, prepare the correct type of screws appropriate to the wall material.

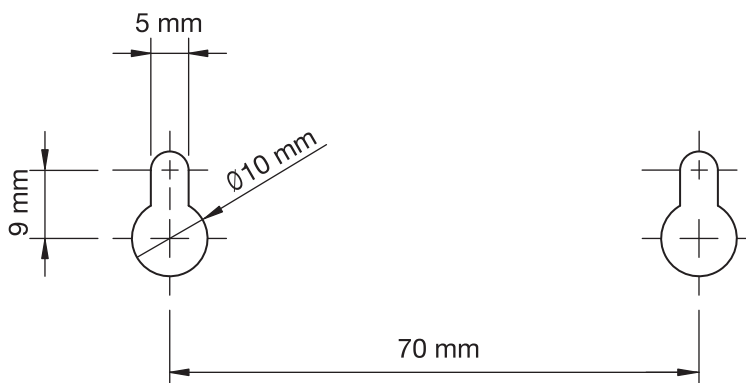

6. CONNECTION EXAMPLE

To AC Mains

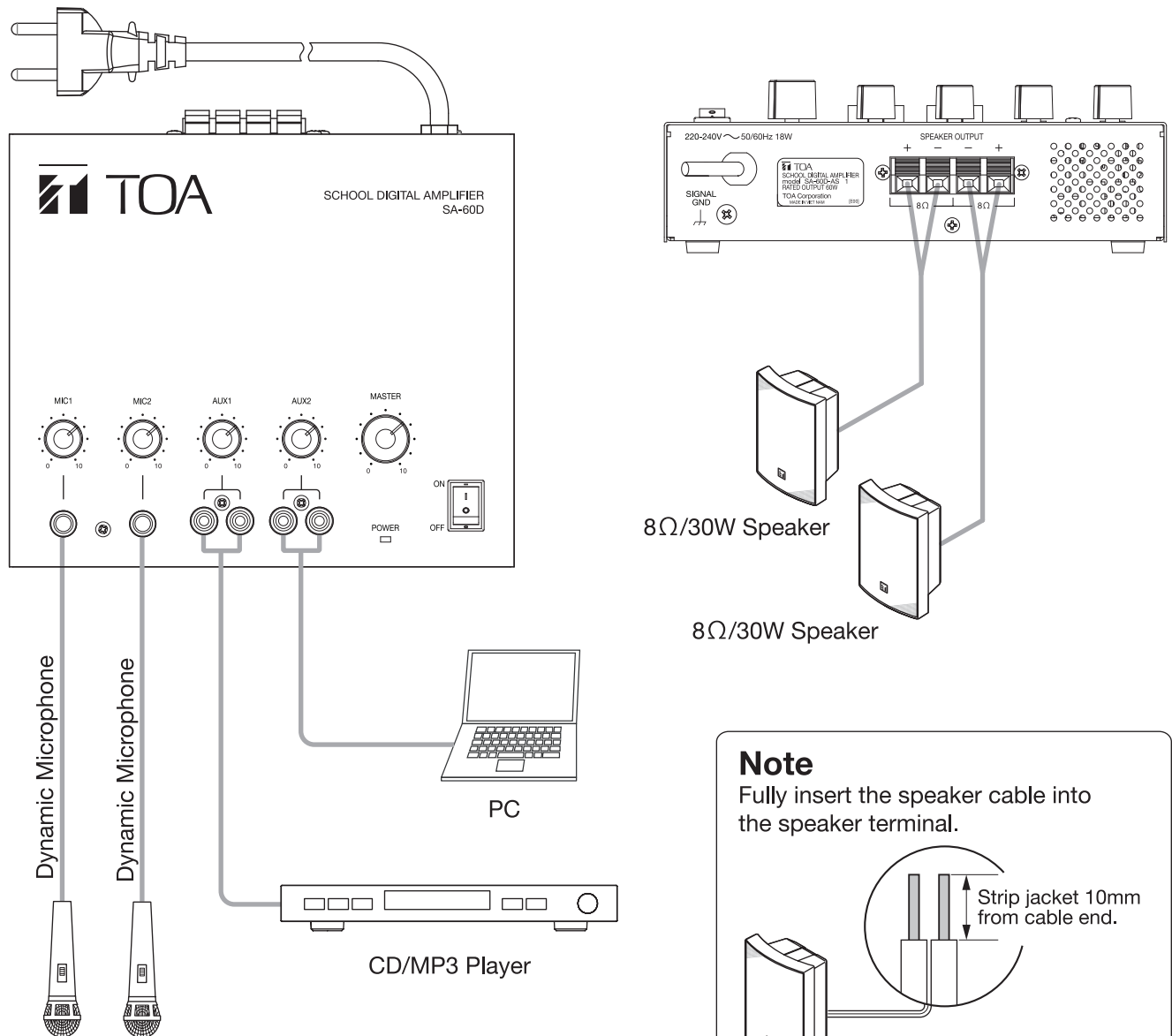

Note

Fully insert the speaker cable into the speaker terminal.

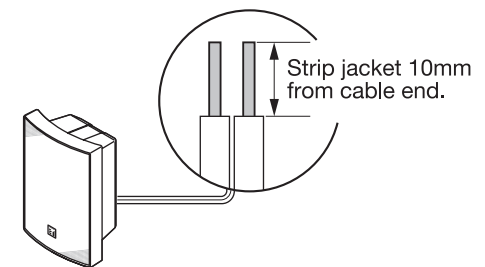

When using multiple speakers, match the speakers' polarities. The total impedance must be higher than 4Ω.

7. VOLUME CONTROL SETTINGS

Output levels are adjustable with individual volume controls. For music play or announcement, adjust the corresponding volume control so that the signal output is not distorted.

Note that the sound quality is downgraded when the output is distorted.

8. DIMENSIONAL DIAGRAM

Unit: mm

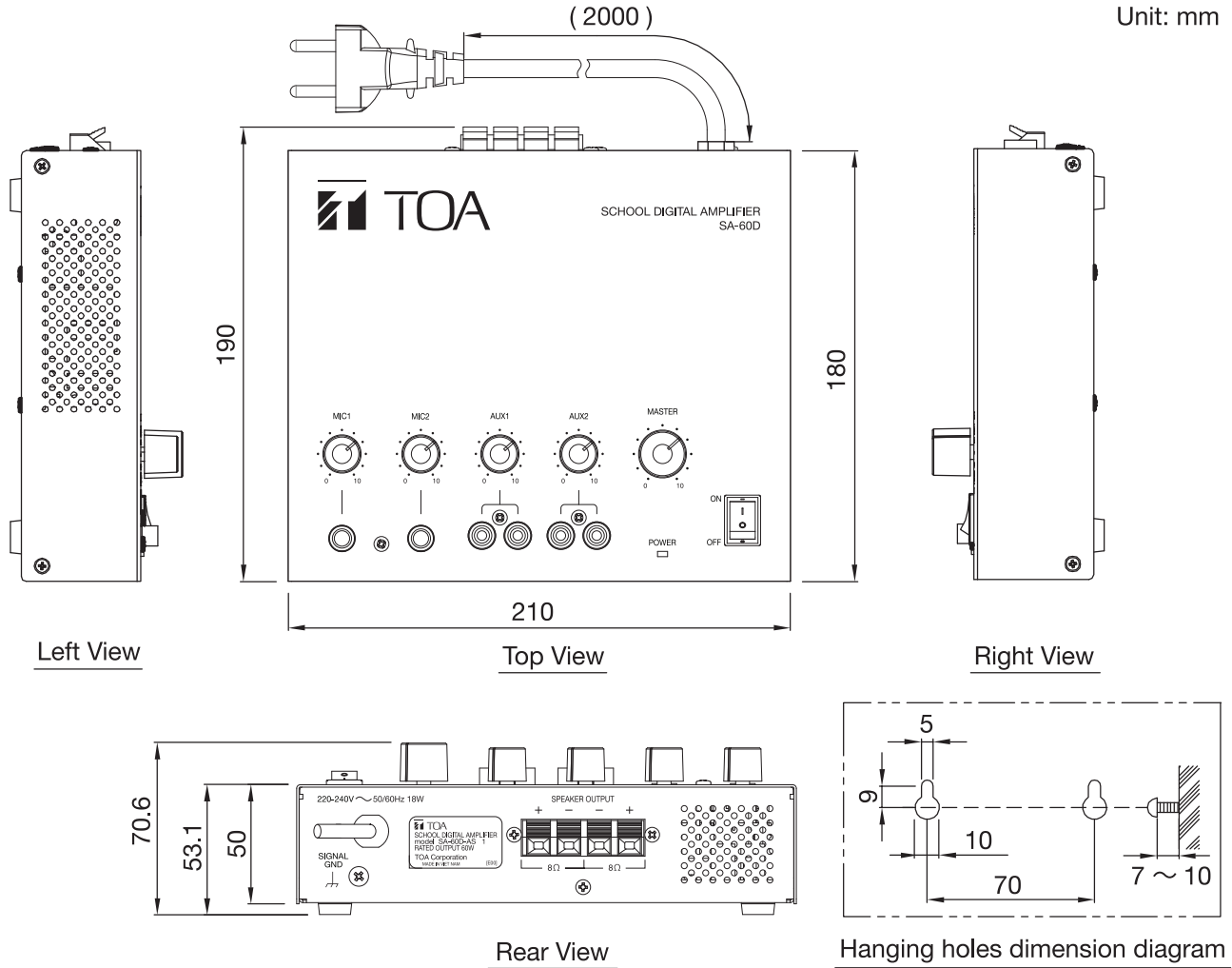

9. SPECIFICATIONS

*0 dB = 1 V

Power Source	220 - 240 V AC 50/60 Hz
Rated Output	60 W
Power Consumption	100 W (rated output), 18 W (EN60065)
Frequency Response	20 - 20,000 Hz
Distortion	1% or less
Input	MIC1, 2: -52 dB*, 600 Ω, unbalanced, φ6.3 phone jack (2P) AUX1, 2: -20 dB*, 10 kΩ, unbalanced, RCA pin jack
Output	Speaker out: Low impedance (2 x 8Ω or 1 x 4Ω), Push-in terminal
S/N Ratio	MIC1, 2: 60 dB or more AUX1, 2: 70 dB or more
Protection	Power Supply Thermal Shut down Power Amplifier Thermal Shut down Power Amplifier Over Current Each protection will be restored automatically
Indicator	Power LED (Blue)
Operating Temperature	0°C to +40°C (32°F to 104°F)
Operating Humidity	90% RH or less (no condensation)
Finish	Case: Steel plate, Off-white, paint Knob: ABS resin, black
Dimensions	210 (W) x 70.6 (H) x 180 (D) mm
Weight	1.6 kg
Accessories	Wall mounting pattern paper x 1

