



**SPECIFICATIONS**

Model	SL-350QFR	SL-350QNR
Maximum detection range	100 m/350 ft.	
Maximum arrival distance	1000 m/3500 ft.	
Detection method	Quad infrared beam interruption detection	
Selectable beam frequency	4 channels	
Interruption time	Variable between 50/100/250/500 ms (4 steps)	
Power source	Recommend: 3.6 V, 13.0Ah LSH20 lithium batteries manufactured by SAFT	
	Operating range: 3.2 V - 4.0 V lithium batteries Transmitter: 2 or 4 units, Receiver: 2 or 4 units	
Current draw	745µA	
	Transmitter: 420 µA + Receiver: 325 µA (at 25°C, 3.6 VDC)	
Battery life **	Transmitter: Approx. 4 years Receiver: Approx. 5 years	
	Alarm output Form C-Solid State Switch: 3.6 VDC, 0.01 A	
Output	Alarm period 2 sec (±1) (Nominal)	
	D.Q output Form C-Solid State Switch: 3.6 VDC, 0.01 A (Receiver only)	
	Low battery output N.C. (mechanical switch): 3.6 VDC, 0.01 A	
	Tamper output (cover, back box, main unit) N.C. (contact output): 3.6 VDC, 0.01 A Opens when cover, main unit or back box is removed.	
	Indicator	
Indicator	Alarm indicator (Receiver) Alarm: ON Light receiving: OFF	
	Level indicator (Receiver) Not Light receiving: OFF Light receiving: Flickering or OFF	
	Power indicator (Transmitter) Power ON: ON Power OFF: OFF	
	Low battery indicator Voltage reduction: Flickering	
Operating temperature	-20°C - +60°C (-40°F - 140°F)	
Operating humidity	95 % (max.)	
Alignment angle	±90° Horizontal, ±10° Vertical	
Dimension	H x W x D mm(inch): 452 (17.9) x 83 (3.3) x 138 (5.4)	
	Weight 3300 g (Total weight of Transmitter + Receiver, excluding accessories)	
International protection	IP65	

Specifications and design are subject to change without prior notice.  
\* The value is based on the condition that it is used within the ambient temperature range of 20 to 25°C. (LSH-20 x2 pcs)  
\*\* Using batteries other than those recommended may shorten the battery life.

**DIMENSIONS**

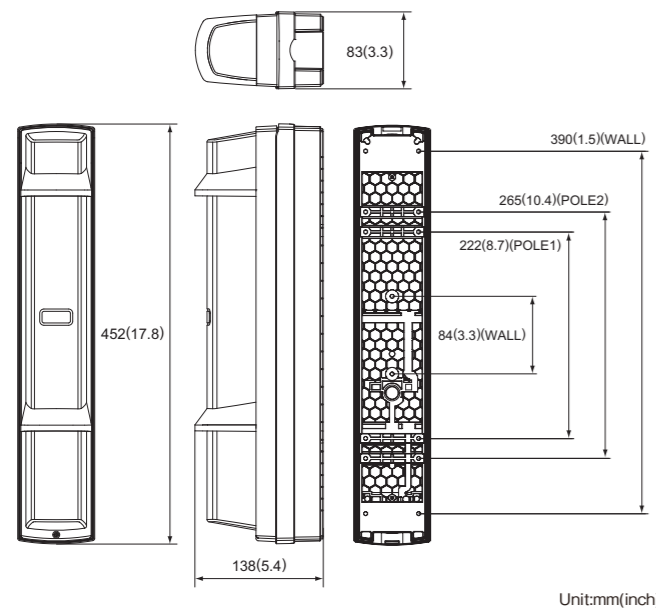

**OPTIONS**

**Anti Bird Cap ABC-4**

Keep birds and small animals off the detector to reduce false alarms. Stop rain and snow streaming in front of the detector to keep the sensitivity.



**Back Cover BC-4**

Conceal the back side of pole mounted detector.



**Pole Side Cover PSC-4**

Conceal the gap between detectors mounted back to back.



**Beam Alignment Unit BAU-4**

Align optical axis automatically. (receiver only)



**Extension Cable with Connector EC-4**

Extension cables between the back box and the main unit when installing to the beam tower.

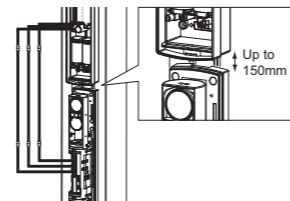

Cable length: 500 mm (19.7 inch)

**SHORT RANGE MODELS**

Battery operated photoelectric detector



**AX-100TFR** 30m / 100ft.  
**AX-200TFR** 60m / 200ft.

**Work Smart,  
"ENJOY WIRELESS"**

- **LONG DISTANCE : 100m / 350ft. -**
- **LONG BATTERY LIFE : 4 to 10 years -**
- **LONG TERM DURABILITY : IP65 -**

BATTERY OPERATED PHOTOELECTRIC DETECTOR

**Smart Line™ series**  
**SL-350 QFR**  
4ch. beam frequencies selectable model  
**SL-350 QNR**  
Standard model



**OPTEX CO., LTD.** (ISO 9001 Certified / ISO14001 Certified)  
5-8-12 Ogino, Otsu, Shiga, 520-0101 Japan  
TEL +81(0)77 579 8670 FAX +81(0)77 579 8190  
OPTEX INCORPORATED (USA) <http://www.optexamerica.com/>  
OPTEX (EUROPE) LTD. (UK) <http://www.optex-europe.com/>  
(ISO9001 Certified)  
OPTEX SECURITY SAS (FRANCE) <http://www.optex-security.com/>  
OPTEX KOREA CO., LTD. (KOREA) <http://www.optexkorea.com/>  
OPTEX SECURITY Sp. z o.o. (POLAND) <http://www.optex.com.pl/>  
OPTEX (DONGGUAN) CO., LTD. <http://www.optexchina.com/>  
SHANGHAI OFFICE (CHINA)

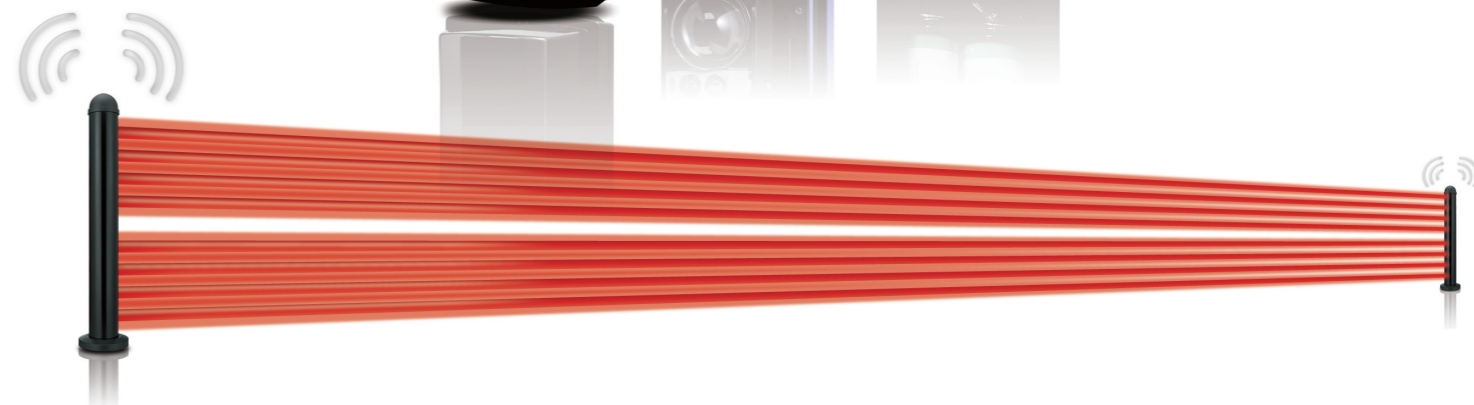

# Revolution in the perimeter security industry.

Optex offers a less expensive and more efficient solution with SL-350QFR/SL-350QNR. Typical perimeter systems require expensive trenching or much time for installation. Expensive wire conduit runs and concrete work is unnecessary, allowing installers to save time and money.

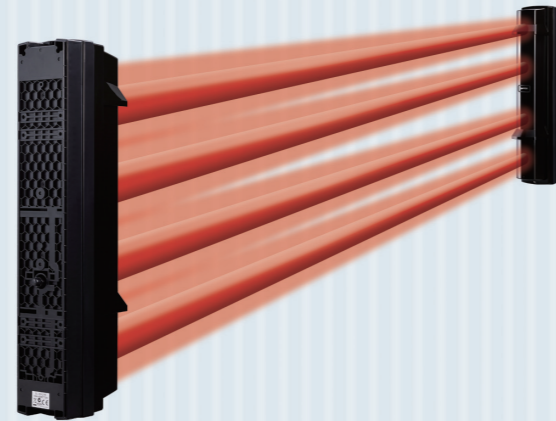

## Advantage of wireless system

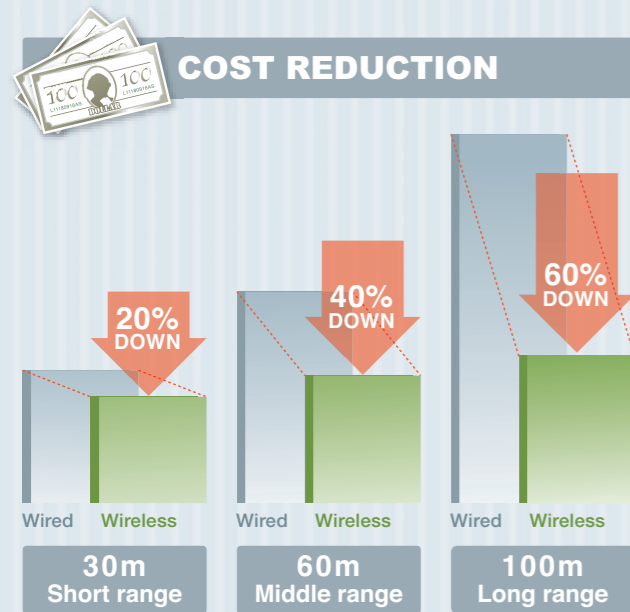

- 1 Low installation costs
- 2 Quick & easy installation
- 3 Flexible location
- 4 Wireless stylish design
- 5 Free from lightning damage

## SAVE TIME

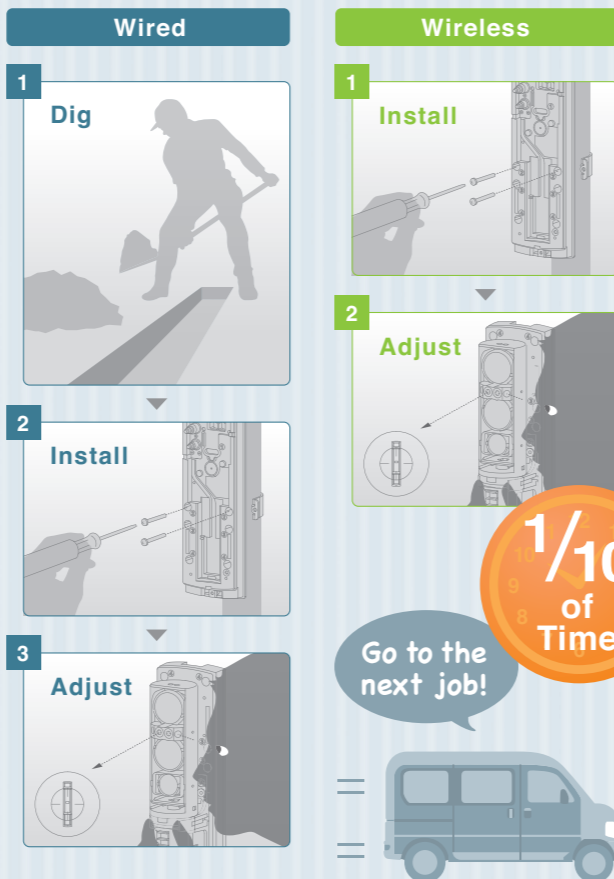

## Various mounting patterns

Please see the last page for more information on the optimal products.

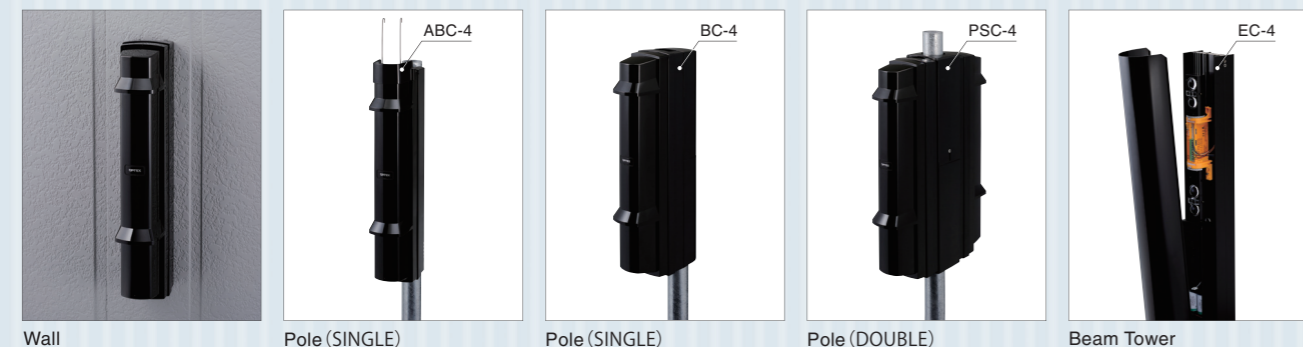

## LONG BATTERY LIFE

Approx. 4 years Max. 10 years

Low current consumption  
 Transmitter 420µA (0.42mA)  
 Receiver 325µA (0.325mA)

When using LSH (3.6V, 13Ah) batteries manufactured by SAFT.



	Transmitter	Receiver
4 pcs	Approx. 8 years	Approx. 10 years
2 pcs	Approx. 4 years	Approx. 5 years

## WIRELESS-READY

The SL-350QFR and SL-350QNR, our wireless ready, battery operated photoelectric detectors are designed to work with most manufacturer's wireless transmitters, and the back box has enough space to accommodate them. They are easy deployable and adaptable to any control systems currently installed.



## Sniper viewfinder Patent pending

False alarms would be reduced if we can make perfect alignment at the first step. This new telescopic lens has a high level of visibility for optical alignment work. Even when it is the long distance, it can make perfect installation in short period and ensure stable performance. The actual performance of product is highly dependent on not only product quality but also installation quality.

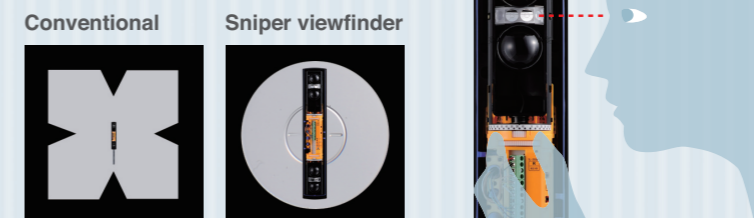

## Weather protection IP65



Smart line series are protected from interruption caused by insects, dirt sander or humidity.

## Spacious back box

The following figure shows the dimensions of the wireless transmitter installation space in the back box. Note that transmitter with greater dimensions are not applicable.

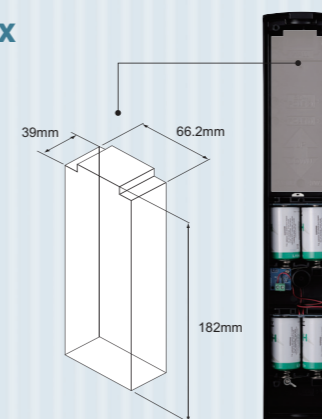

## Basic performance

- 99% beam blocking stability
- 4 selectable beam frequencies (SL-350QFR only)
- Beam interruption adjustment function
- Triple tamper function (front cover, back box and wall)
- D.Q.circuit (enviromental disqualification)
- High grade aspherical lens
- Form C(N.C./N.O.) output
- Battery saving function
- Intermittent output function
- A.G.C.(Automatic Gain Control) circuit