



The CM 561 Flush Mount Ceiling Loudspeaker is designed for low ceiling applications in a public address system. The unit consists of a dual cone full range loudspeaker driver, capable of delivering up to 98 dB of Sound Pressure Level (SPL) with a frequency response of 100 Hz ~ 20 kHz, making the unit excellent for speech and music reproduction applications.

The unit's built-in line matching transformer makes it suitable for a 70 V and 100 V distributed speaker system. Multiple power tapings on the transformer allows for outputs of 6, 3 and 1.5 W (100 V) / 3, 1.5 and 0.8 W (70 V).

The loudspeaker driver unit is mounted onto an aesthetically pleasing 200 mm circular metal grille finished with a matted surface in White. The whole unit is spring mounted to the ceiling board makes installation simple and effective without any visible screw mounting holes.

There is also a back enclosure model available (CM 561E). With the metal back enclosure, crosstalk within the ceiling cavity can be prevented while acoustic damping material lining the enclosure reduces echoing.

- 200 mm circular white epoxy coated metal grille and covered with a metal perforated mesh.
- Dual cone full range speaker driver unit, suitable for general PA applications that calls for speech and music clarity.
- Spring mounted installation to eliminate visible mounting screws.
- Ready fitted line matching transformer with multiple impedance tapings, suitable for 70 V and 100 V distributed speaker system.
- Carefully designed with simplicity in installation & finished aesthetically for ease of matching to any ceiling type and interior facade.



CM 561



CM 561E

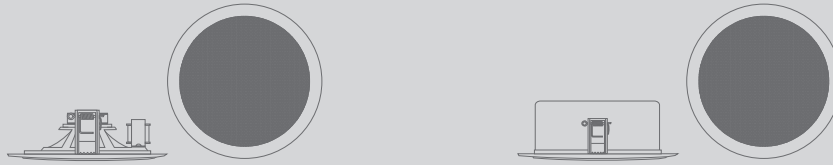

Technical Specifications

	CM 561	CM 561E
Rated Input (100 V)	100 V : 6 W (6 - 3 - 1.5 W) 70 V : 3 W (3 - 1.5 - 0.8 W)	100 V : 6 W (6 - 3 - 1.5 W) 70 V : 3 W (3 - 1.5 - 0.8 W)
Maximum Power	9 W	9 W
Rated Impedance	1.7 kΩ (1.7 - 3.3 - 6.7 kΩ)	1.7 kΩ (1.7 - 3.3 - 6.7 kΩ)
Sensitivity (1 W / rated at 1 m)	90 / 98 dB	90 / 98 dB
Coverage Angle (1 kHz, -6 dB)	180 deg.	180 deg.
Frequency Response	100 Hz ~ 20 kHz	115 Hz ~ 20 kHz
Speaker Component	130 mm Dual Cone Full Range Loudspeaker	130 mm Dual Cone Full Range Loudspeaker
Safety	Acc. to EN 60065	Acc. to EN 60065
Finish	Grille and Mesh; White	Grille and Mesh; White
Dimensions (W x H x D)	Dia 200 x 50 mm	Dia 200 x 90 mm
Weight	0.73 kg	0.93 kg

Frequency Response

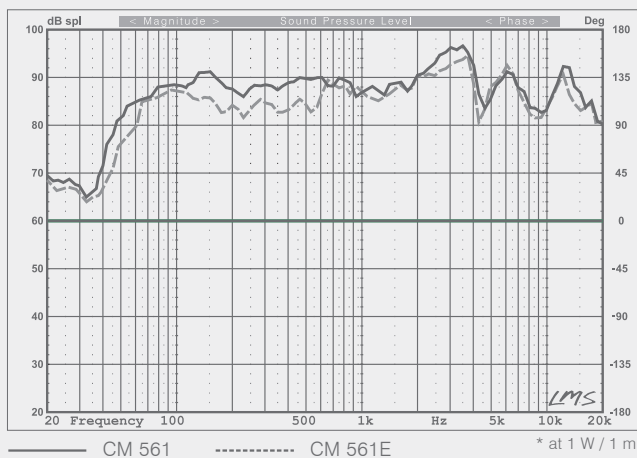

SPL Polar Plot

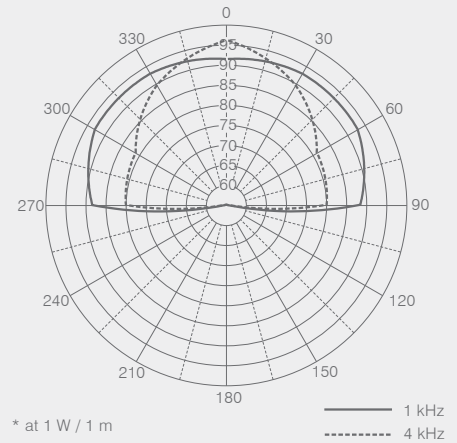

Engineers' Specifications

The flush mount ceiling loudspeaker unit shall consist of a 120 mm dual cone full range speaker driver, mounted on to a 200 mm circular white metal grille. The unit shall be spring mounted to the ceiling to avoid visible mounting screw. A line matching transformer shall be provided with multiple power tapings of 6, 3 & 1.5 W (100 V) / 3, 1.5 & 0.8 W (70 V) suitable for distributed speaker systems. The loudspeaker unit shall have a useable frequency range of 100 Hz ~ 20 kHz (CM 561) / 115 Hz ~ 20 kHz (CM 561E) with a minimum SPL

of 90 dB at 1 W / m, 1 kHz and a coverage angle of 180 deg.. The weight of the loudspeaker unit shall not exceed 0.73 kg (CM 561) / 0.93 kg (CM 561E). Dimensions shall be not more than 200 mm diameter and depth 50 mm (CM 561) / 90 mm (CM 561E).

