

H3 Series Counting Scale User Manual

© EXCELL PRECISION CO., LTD. 2015. All rights reserved worldwide.

The information contained herein is the property of EXCELL PRECISION CO., LTD. and is supplied without liability for errors or omissions. No part may be reproduced or used except as authorized by contract or other written permission. The copyright and the foregoing restriction on reproduction and use extend to all media in which the information may be embodied.



Table of Contents

Instruction for Use 3

Preparations before Using 3

Chapter 1 Display and Keypad Descriptions 5

 1-1 Display Descriptions 5

 1-2 Keypad Descriptions 6

 1-3 Error Messages 7

 1-4 Self-Test Mode 8

 1-4-1 Check Software Version Number 01 Ver 9

 1-4-2 Check Key and LCD BL Test 02 dSP 9

 1-4-3 Read AD Value 03 AdC 9

 1-4-4 Keypad Test Code 04 eEY 10

 1-4-5 EEPROM Switch Calibration Test 05 eEP 11

 1-4-6 Real Time Clock (RTC) 06 rTc 11

 1-4-7 RS-232 07 rS l 12

 1-4-8 Read free format PCB Software Version Number 08 P r t 12

 1-4-9 Read Temperature IC AD Value 10 t a P 12

 1-4-10 Read Battery AD Value 11 b a t 13

 1-4-11 ESC (leave test mode) 00 e s c 13

Chapter 2 Operation 14

 2-1 Power On 14

 2-2 Relatively Internal Value Display 14

 2-3 High and Low Resolution Shift Setting 14

 2-4 Zero Function 14

 2-5 Sampling Function 14

 2-5-1 Unknown Unit Weight of a Weighed Object 14

 2-5-2 Known Unit Weight of a Weighed Object 15

 2-5-3 Under Tare Status 15

 2-6 Tare Function Operation 16

 2-7 Pre-tare Function Operation 16

 2-8 Accumulation 17

 2-8-1 Quantity Accumulation 17

 2-8-2 Weight Accumulation 18

 2-9 Quantity Preset 18

 2-10 Weight Preset 19

 2-11 ID Input 19

 2-12 Item Input 20

 2-13 Unit Weight Preset 20



Chapter 3 External Calibration Setting..... 22

3-1 External Function Setting 0 1 F n C..... 22

3-1-1 Backlight Mode Setting F n C 0 1..... 23

3-1-2 Auto. Power-off Setting F n C 0 2..... 23

3-1-3 Stable Range Setting for Quantity Sampling F n C 0 3..... 24

3-1-4 Auto. Average Unit Weight Setting F n C 0 4..... 24

3-1-5 A/D Sampling Speed Setting F n C 0 5..... 25

3-1-6 Zero Display Range Setting F n C 0 6..... 25

3-1-7 Zero Tracking Range Setting F n C 0 7..... 26

3-1-8 Accumulation Ending Mode Setting F n C 0 8..... 26

3-1-9 Pre-tare mode setting F n C 0 9..... 27

3-1-10 “Beeper” Output Setting for Quantity Limit F n C 1 0..... 27

3-1-11 Accumulation Acceptable Condition Setting 1 F n C 1 1..... 28

3-1-12 Accumulation Acceptable Condition Setting 2 F n C 1 2..... 28

3-1-13 Combination Key Setting F n C 1 3..... 29

3-2 RS-232 and Serial Printer Setting 0 3 r 5 1..... 30

3-2-1 Baud Rate Setting r 5 1 0 1..... 30

3-2-2 Communication Protocol Setting r 5 1 0 2..... 31

3-2-3 Output Data Format Setting r 5 1 0 3..... 31

3-2-4 Output Count Setting Per-second r 5 1 0 4..... 33

3-2-5 Operation Mode Setting r 5 1 0 5..... 33

3-2-6 Continuous Transmission Output Condition Setting r 5 1 0 6..... 35

3-2-7 Zero Band Setting for Auto. Transmission r 5 1 0 7..... 36

3-2-8 Weight Band Setting for Auto. Transmission r 5 1 0 8..... 36

Appendix 1 RS-232 Full Duplex Format..... 37

Appendix 2 Fixed Format RS-232 Transmission Line Description 39

Appendix 3 ASCII Code Table..... 40

Appendix 4 7-Segment Display Characters 41



Thank you for purchasing EXCELL counting scale.
In order to operate smoothly, to last the durability
and to reduce chance of breakdown for this product,
Please read this manual carefully.

Instruction for Use

1. The scale should not be drenched by rain or water. (If it gets wet carelessly, please wipe it dry with a cloth. If its operation is abnormal, please send it to our distributor for service)
2. Please keep the scale in a cool and dry place. Do not store at high temperature or damp places.
3. Please keep the scale clean and free from insect infestation.
4. To avoid impact and it is to be used under designated pressure (the weight put on the platter can not exceed the maximum capacity of the scale)
5. If the scale is not going to be used for some time, please clean in and store it in a plastic bag with desiccative. The internal rechargeable battery should be recharged every three months. (If using dry batteries, take the dry batteries out before storing)
6. The commodity should be placed in the center of platter for accurate weighing. The dimension of the weighted commodity should not exceed the dimension of platter.
7. In order to maintain the re-chargeable battery in good condition it should be kept fully charged whenever possible. If the scale is to be stored, the battery should be fully charged before storage, and then re-charged at 3 month intervals. The number of times that the battery can be recharged will vary according to the conditions of use. However it can be maximized by re-charging the battery frequently and by avoiding conditions of total discharge. The battery cannot be overcharged.
8. Please operate or charge the scale in an open area. Do not squeeze the power cord to avoid wire on fire.
9. Operating temperature: $-10^{\circ}\text{C} \sim +40^{\circ}\text{C}$
10. Any suggestion for the product is warmly welcome.

Preparations before Using

1. Put the scale on a firm and flat surface for accurate weighing reading. Adjust the four leveling feet to get the leveling bubble at the center of the circle.
2. Scale must be used under a stable temperature and stable air flow. Avoid direct sunlight onto the scale or near the air-conditioning outlet.
3. Scale must be used under individual socket to avoid the interference of other electric appliances.
4. Remove any weight that might be on the platter before the scale is switched on.
5. The scale requires 15 ~ 20 minutes warm up before operation to ensure best accuracy.
6. When  symbol appears on the screen, the internal battery needs to be replaced.
7. Introduction of Storage Battery



Due to the storage battery adopt the advanced free-maintaining technique, customers need not to replenish electrolyte.

The scale should be recharged every 3 months to prevent failure of the internal rechargeable battery.

1. The battery should be charged for 8~10 hours.
2. The temperature of battery should below 45 .

Maintaining

1. Please do not discharge with over-current when using the battery. Please charge the battery after discharging current.
2. Please take down the battery when the scale is not used for a long time or break the connection of cathode.
3. Do not short the battery terminals to check whether there is current. Please check whether the connection point is firm to guarantee good connection.
4. The battery should be replaced by specialized person. **No reverse-battery or the product will be damaged.**
 - a) Anode of battery should be connected with Anode of product battery (usually red cable)
 - b) Cathode of battery should be connected with Cathode of product battery (usually brown cable or black cable)
 - c) See the picture following

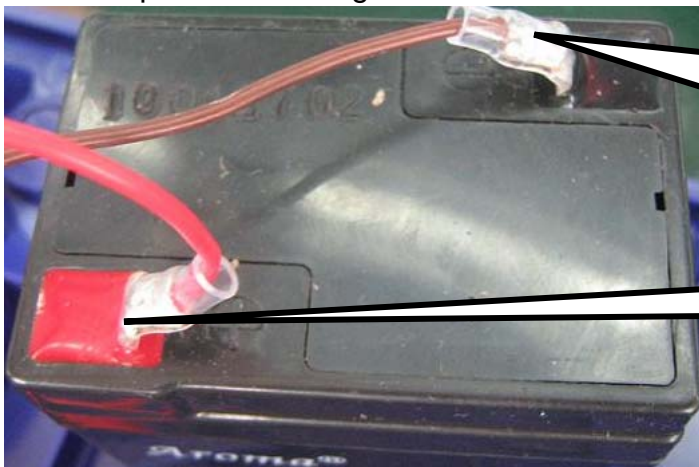

Brown cable(or black cable) connected with Cathode of battery

Red cable connected with Anode of battery

Safety warnings

1. The electrolyte of battery is caustic which causes metal, cotton, etc to corrode.
2. The hydrogen will be resolved when using or charging the battery and it will cause explosion when approaches fire.



No burning



Caution Corrosion



Warning explosion



Children faraway



Chapter 1 Display and Keypad Descriptions

1-1 Display Descriptions

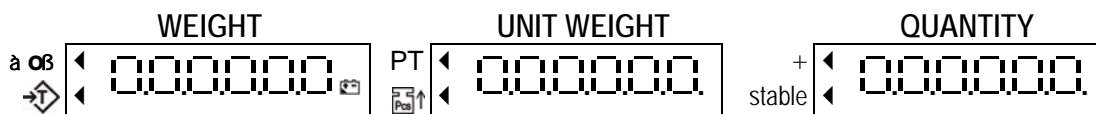

Display Column

1. WEIGHT

Total 6 digits. To display the weight on platter or the total accumulation weight; the left digit is able to display the negative symbol.

2. UNIT WEIGHT

Total 6 digits. To display the unit weight of objects on the platter or total accumulation counts.

3. QUANTITY

Total 6 digits. To display the quantity of the objects on platter or the accumulation.

Symbol Icons “ ◀ ”

1. or Net or Tare : “Tare” indication
2. or Zero : “Zero” indication
3. or M+ : “Accumulation” indication
4. : “Stable” indication
5. : “Pretare” indication (for approval models)
6. : If the unit weight of the object on the platter is less than “Minimum Unit Weight”, this symbol will display. The scale can still count the quantity even though the unit weight is too small; however, this may affect the counting inaccuracy.
Please use the scale which the division and specification are both subject to.
(If symbol displays, scale may cause some counting error even if the scale can still be used.

Brazil approval model (1/3,000 resolution)

Minimum unit weight is 0.1d (d=division)

When minimum unit weight is less than 0.1d, it will display “ - - - - - ” and can't be counted.

Other approval model (except for Brazil approval model)

Minimum unit weight is 0.1d with resolution equal to 1/3000. (d=division)

Minimum unit weight is 0.2d with resolution range from 1/6,000 to 1/3,000.

7. : When the symbol displays, the battery need to be recharged for safe use.



1-2 Keypad Descriptions

[Standard keypad]

7 ┌	8 ABC	9 DEF	SAMPL	Q'TY PST
4 GHI	5 JKL	6 MNO	UNIT W.T	PST CE
1 PQRS	2 TUV	3 WXYZ	Z	M+
0	.	CE	T	MC

[Double weighing units keypad]

7 ┌	8 ABC	9 DEF	SAMPL	Q'TY PST
4 GHI	5 JKL	6 MNO	UNIT W.T	kg/lb
1 PQRS	2 TUV	3 WXYZ	Z	M+
0	.	CE	T	MC

[10 sets of preset unit weight keypad]

7 ┌	8 ABC	9 DEF	SAMPL	Q'TY PST
4 GHI	5 JKL	6 MNO	UNIT W.T	U.W PST
1 PQRS	2 TUV	3 WXYZ	Z	M+
0	.	CE	T	MC

Key Function

, : Number key for setting the unit weight, quantity and etc.



: Clear key to clear the digits on the display.

: Unit weight key for setting the unit weight of sample.





: Press this key, the display returns to 0.

: Press this key to deduct the weight of container. Or shift the digit pointer to left.



-  : Pre-setting the upper limit of count. If the calculated count is larger than the limit, the scale sends a warning sound. Or use this key to confirm the setting.
-  : Totalizing the quantity or weight.
-  : Clear the stored totalizing memory. Or shift the digit pointer to right.

Different keys for different models:

-  : Press this key to clear preset.
-  : Press this key to switch the unit : kg or lb
-  : Press this key to preset the unit weight of sample. Or use this key to enter the setting mode.
-  : Press this key and release it within 3 seconds, then user can increase or decrease the number of decimal places. Or press this key over 3 seconds, the display resolution will change from 1/3,000 to 1/30,000 temporarily. The display resolution will return back to 1/3,000 after 5 seconds.

1-3 Error Messages

- $E \ 1$ ⇒ zero value is too high (OMIL or NTEP >10% full scale)
- $E \ 2$ ⇒ zero value is too low (OMIL or NTEP <10% full scale)
- $E \ 6$ ⇒ Internal value >700,000 (use in factory calibration)
- $E \ 7$ ⇒ Internal value <100,000 (use in factory calibration)
- $O \ L$ ⇒ The weight value is over 9d of the maximum capacity. (d = division)
- unstable E ⇒ Internal value is unstable (Unstable time is over 10 seconds after pressing **ZERO** or **TARE** key)



1-4 Self-Test Mode

Hold **ZERO** key to turn on the scale until the display show "SELF TEST". Wait till display Shows "01 0Er" to enter "Self- Test Mode".

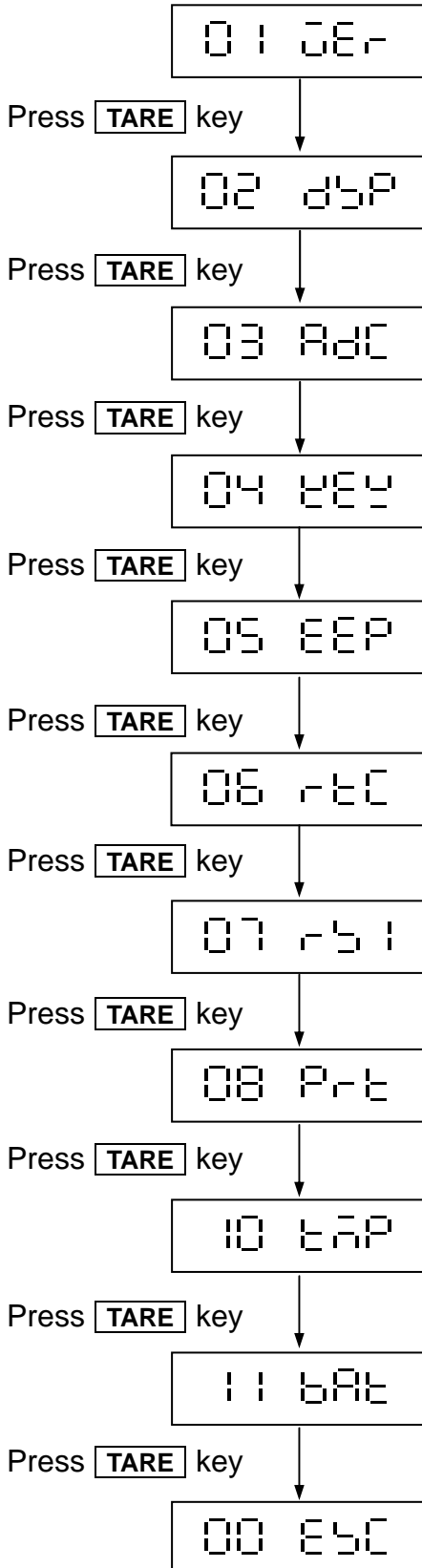

- 01 0Er ⇒ Check Software version number
- 02 d5P ⇒ Check key and LCD BL test
- 03 AdC ⇒ Read AD value
- 04 tEY ⇒ Key test code
- 05 EEP ⇒ EEPROM switch calibration test
- 06 r tC ⇒ Real Time Clock (RTC)
- 07 r 5 1 ⇒ RS-232
- 08 P r t ⇒ Read free format PCB Software version number
- 10 t r P ⇒ Read temperature IC AD value
- 11 b A t ⇒ Read AD value
- 00 E 5 C ⇒ ESC (leave test mode)

- < ⇒ Exit
- CE ⇒ Move cursor leftward
- TARE ⇒ Move cursor rightward
- MC ⇒ Enter



1-4-1 Check Software Version Number 01 0Er

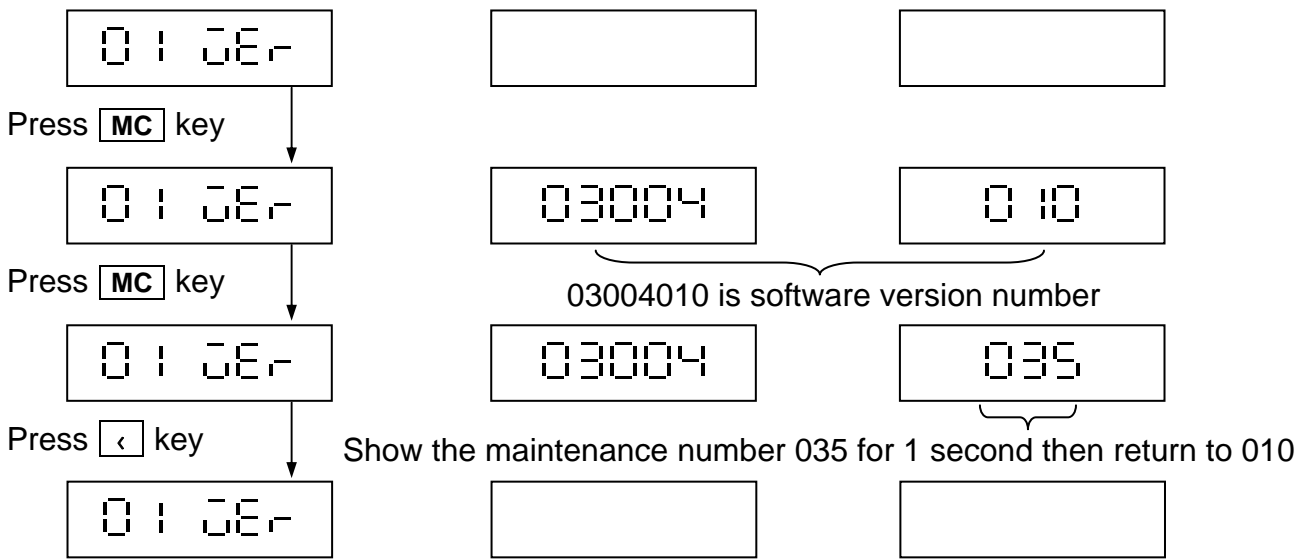

1-4-2 Check Key and LCD BL Test 02 d5P

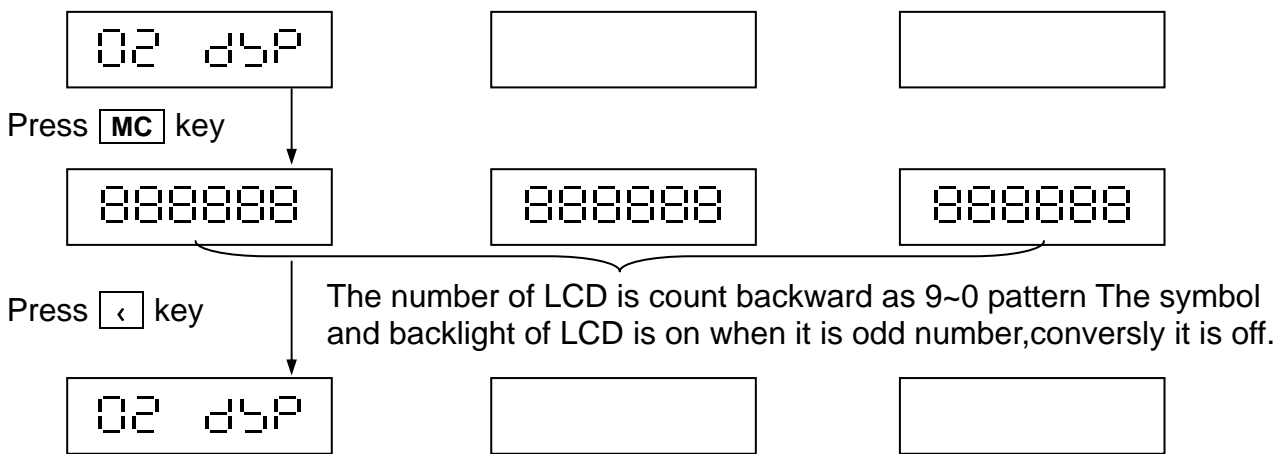

1-4-3 Read AD Value 03 AdC

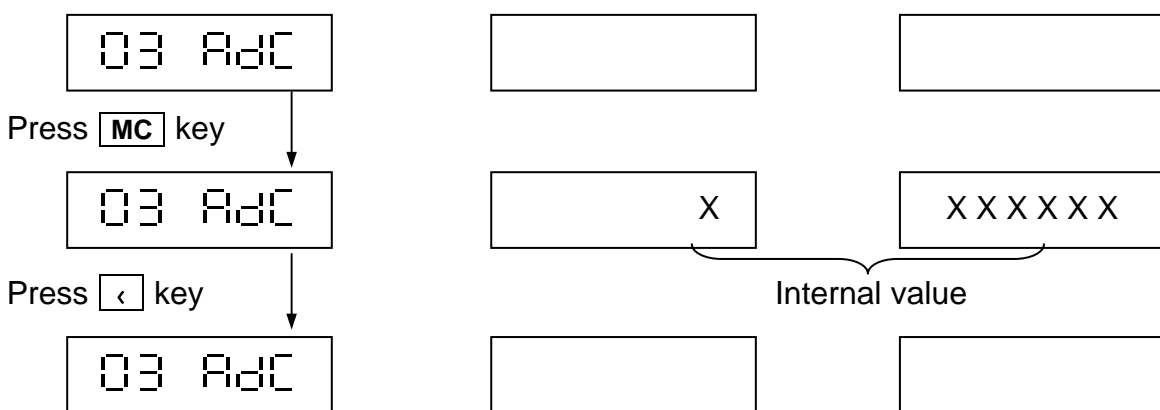

(Check if the internal value is within its normal range (Idler range: 100,000~700,000)

EE ⇒ Internal value >700,000 (S+, S- about +5 mV)

E7 ⇒ Internal value <100,000 (S+, S- about -1.3 mV)

- <** ⇒ Exit
- CE** ⇒ Move cursor leftward
- TARE** ⇒ Move cursor rightward
- MC** ⇒ Enter



1-4-4 Keypad Test Code 04 2EY

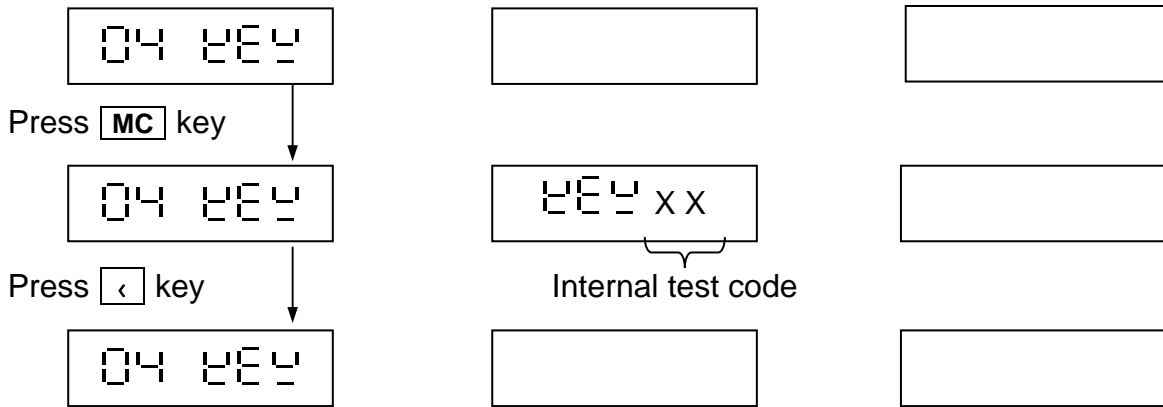

- ← ⇒ Exit
- CE ⇒ Move cursor leftward
- TARE ⇒ Move cursor rightward
- MC ⇒ Enter

Keypad ⇒ Keypad internal test code

7 ┌	8 ABC	9 DEF	SAMPL	Q'TY PST
4 GHI	5 JKL	6 MNO	UNIT W.T	PST CE
1 PQRS	2 TUV	3 WXYZ	Z	M+
0	.	CE	T	MC

⇒

00	10	20	30	40
03	13	23	33	43
01	11	21	31	41
02	ESC	22	32	42

7 ┌	8 ABC	9 DEF	SAMPL	Q'TY PST
4 GHI	5 JKL	6 MNO	UNIT W.T	kg/lb
1 PQRS	2 TUV	3 WXYZ	Z	M+
0	.	CE	T	MC

⇒

00	10	20	30	40
03	13	23	33	43
01	11	21	31	41
02	ESC	22	32	42

7 ┌	8 ABC	9 DEF	SAMPL	Q'TY PST
4 GHI	5 JKL	6 MNO	UNIT W.T	U.W PST
1 PQRS	2 TUV	3 WXYZ	Z	M+
0	.	CE	T	MC

⇒

00	10	20	30	40
03	13	23	33	43
01	11	21	31	41
02	ESC	22	32	42



1-4-5 EEPROM Switch Calibration Test 05 EEP

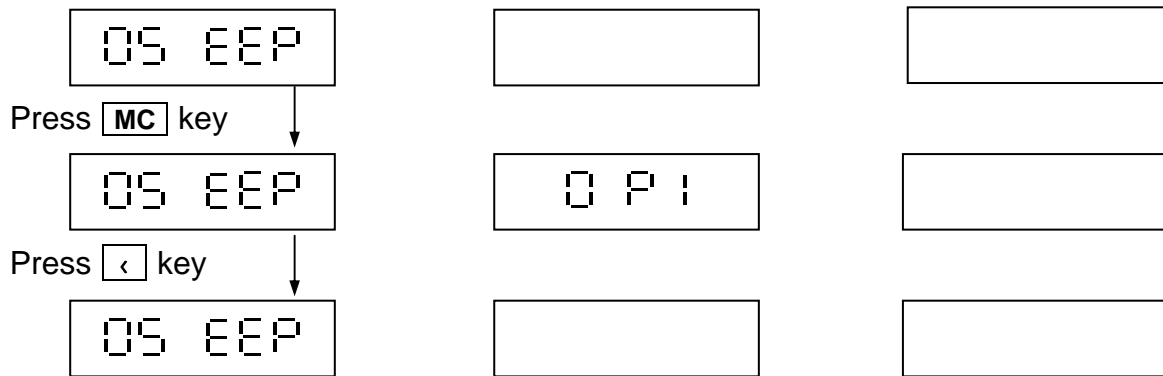

(EEPROM switch test

0 P 1

SWA1 switch test
 0: ADJ
 1: LOCK

EEPROM reading and writing test
 P 1: EEPROM reading and writing is successful
 F 1: EEPROM reading and writing fail
 (EEPROM is uninstalled or damaged)

1-4-6 Real Time Clock (RTC) 06 r t c

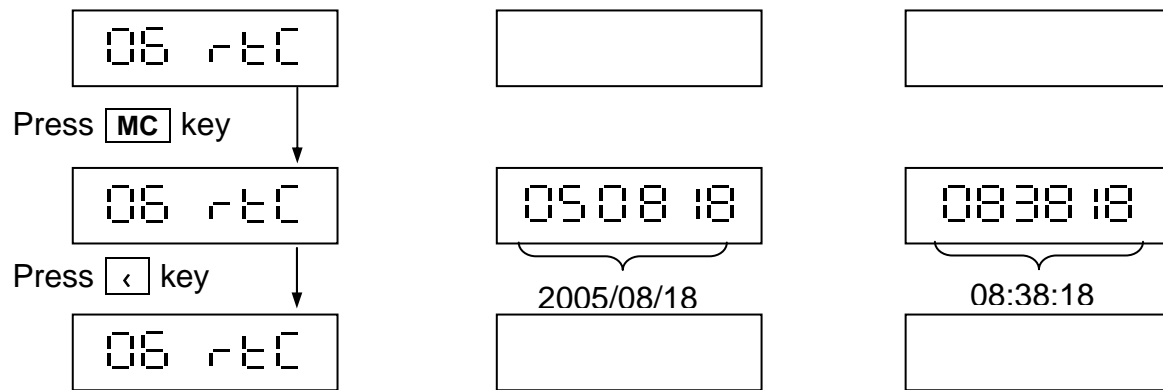

- (12 code numbers standard for: year, month, day, hour, minute, second
- (The display shows 12 zeros and not flicker, which means free format PCB is not been connected to the main board or free format PCB RTC has not been installed.
- (To use number key to set the date and time of RTC, then Press **<** key to finish setting.

< ⇒ Exit

CE ⇒ Move cursor leftward

TARE ⇒ Move cursor rightward

MC ⇒ Enter



1-4-7 RS-232 07 r51

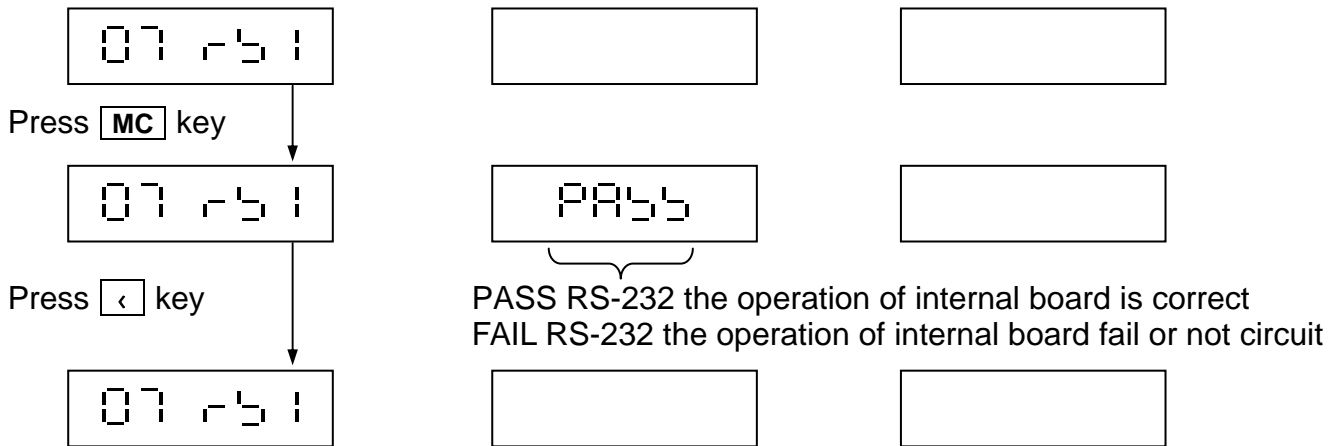

(The test can only test whether the transmission and reception operates regularly in internal software.

1-4-8 Read free format PCB Software Version Number 08 Prt

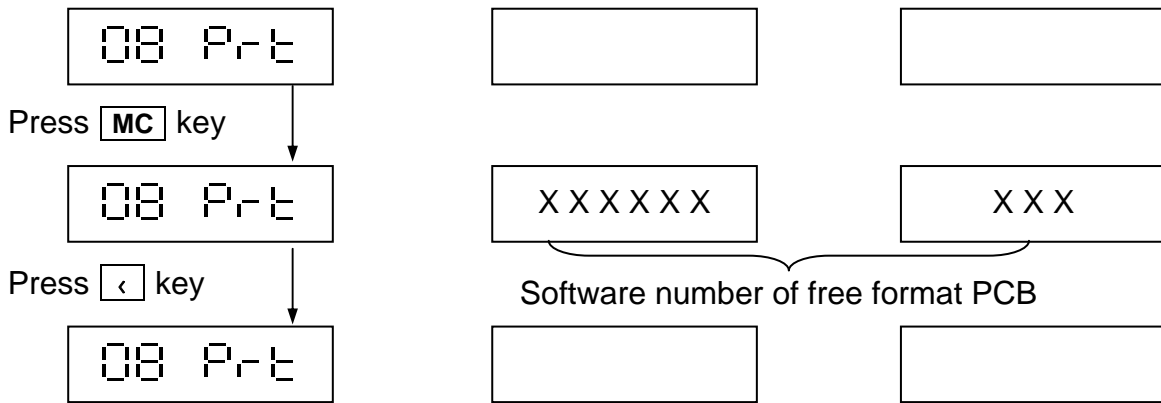

- (The main board transmit "T"+0DH+0AH (ASCII) 3 byte to free format card to read the version number of free format PCB shows on LCD
- (If free format PCB is not been connected or there is something with free format PCB, it will show FAIL.

1-4-9 Read Temperature IC AD Value 10 tAP

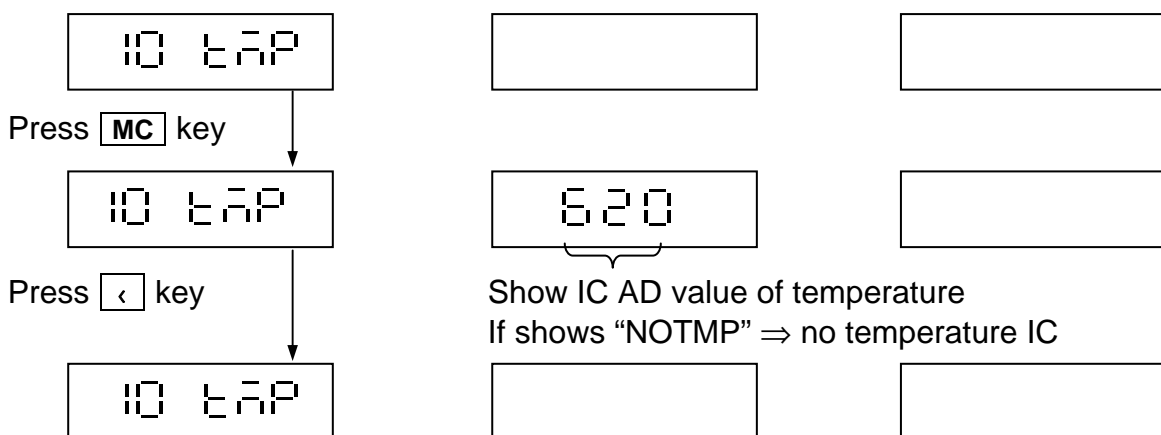



1-4-10 Read Battery AD Value 11 bAt

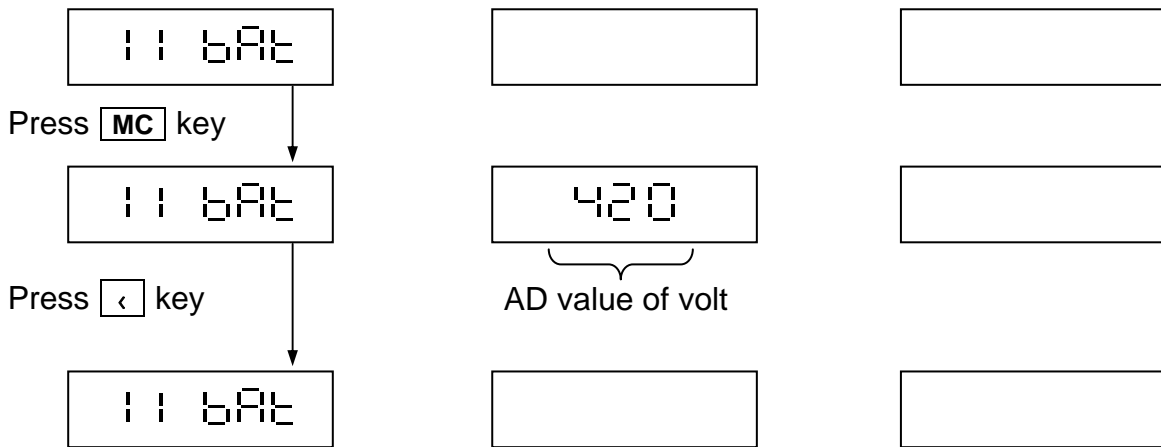

(If AD value of volt is less than 398, it will show  (about 5.8 V)

1-4-11 ESC (leave test mode) 00 E5C

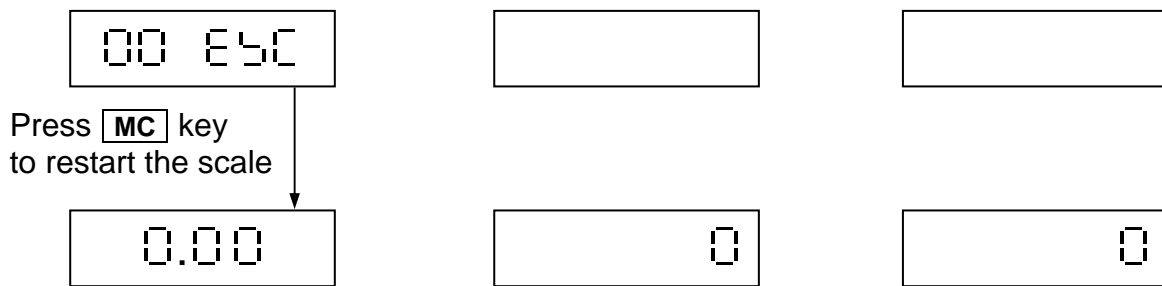

- <** ⇒ Exit
- CE** ⇒ Move cursor leftward
- TARE** ⇒ Move cursor rightward
- MC** ⇒ Enter



Chapter 2 Operation

2-1 Power On

SW switch on (Press SW to location “ ”)

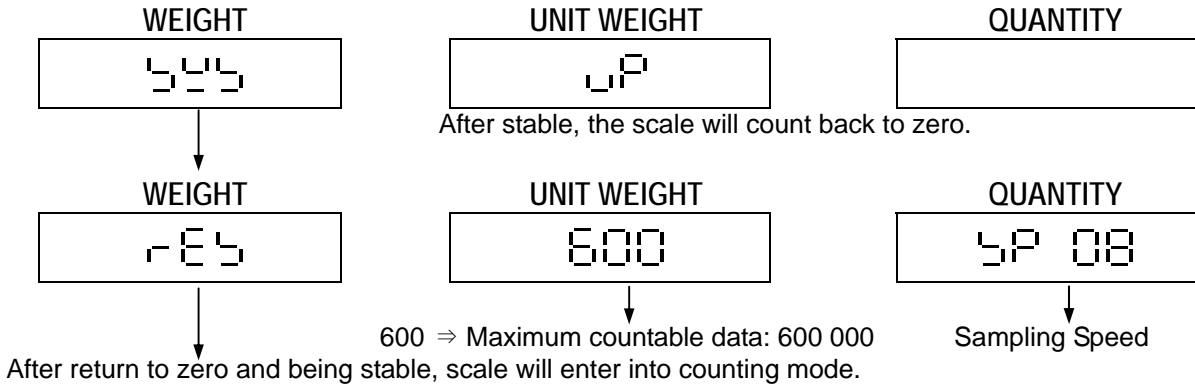

2-2 Relatively Internal Value Display

After press **ZERO** key, screen will show “ - - - - - ”. Press **CE** key.

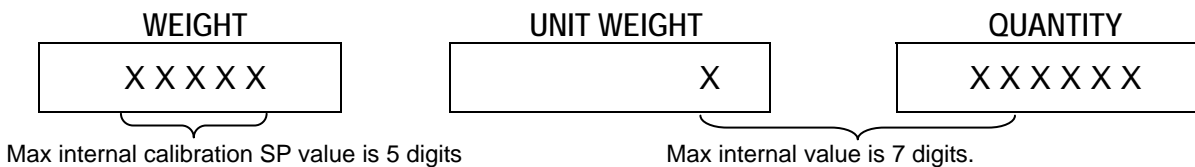

Press **0** key to return to the counting mode.

2-3 High and Low Resolution Shift Setting

- (Only for 1/3,000 resolution models
- (The function is subject to OIML and Brazil Approval models.
- (Press key and then release this key in 2.5 seconds until 3 seconds, this key has decimal function.
- (Press key and then not to release in 3 seconds, the resolution in weight column will convert to 1/30,000 and return back to 1/3,000 in 5 seconds.
- (When resolution converts to 1/30,000, key and Printer are not available.

2-4 Zero Function

While operating the scale, zero may sometimes fluctuate. (Slight weight changes happen in weight column.) Press **ZERO** key to return to zero.

2-5 Sampling Function

2-5-1 Unknown Unit Weight of a Weighed Object

1. Place the sampling object on platter

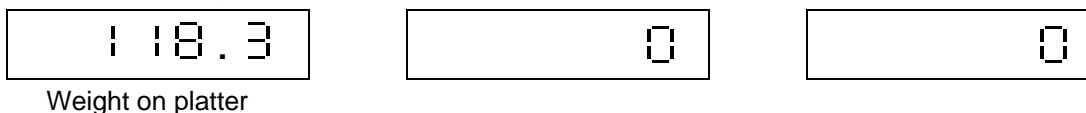



2. Enter the quantity of the sample on platter

118.3

Weight on platter

100

Enter the sampling quantity

≥ 1 ≤

(The number of quantity column will flash 6 seconds. If the user doesn't press the **SAMPLE** key before flashing is over, the scale will complete the unit weight setting procedure automatically after flashing. The scale will also take the number that inputted in unit weight column as the unit weight of object to calculate the quantity of object shown in quantity column.

3. Press **SAMPLE** key while total column number is flashing

118.3

Weight on platter

SAMPLE

4. After stable, the scale finishes sampling and enters into counting mode

118.3

Weight on platter

1.1833

Unit weight of object

stable ← 100

Enter sampling quantity

2-5-2 Known Unit Weight of a Weighed Object

1. Enter known unit weight of object intended to weigh

a ON ← 0.0

1.833

Unit weight of object intended to weigh

stable ← ≥ 0 ≤

2. Press **UNIT WEIGHT** key to complete setting and enter into counting mode

a ON ← 0.0

1.833

Unit weight of object intended to weigh

stable ← 0

2-5-3 Under Tare Status

1. Take the sample off the platter

-59.8

The weight of object on platter

0

0

2. Input the quantity of sample on the platter

-59.8

The weight of object on platter

0

Enter the quantity of sample

≥ 6 ≤

(The number of quantity column will flash 6 seconds. If the user doesn't press the **SAMPLE** key before flashing is over, the scale will complete the unit weight setting procedure automatically after flashing. The scale will also take the number that inputted in unit weight column as the unit weight of object to calculate the quantity of object shown in quantity column.

3. Press **SAMPLE** key while the number of quantity is flashing

-59.8

Weight of the object on platter

SAMPLE

4. After stable, the scale finishes sampling and enters into counting mode

-59.8

Weight of the object on platter

5.98500

Unit weight of object

stable ← 10

quantity of sample entered



- (The larger quantity of sampling, the more precise unit weight counted out.
- (When unit weight column and total quantity column both indicate 0, please press **UNIT WEIGHT** key, and the previous unit weight value will come out.
- (Use **+** and **7** keys to decide whether to display negative weight or not.

2-6 Tare Function Operation

1. Place the packaging container on platter



Weight of packaging container

2. Press **TARE** key

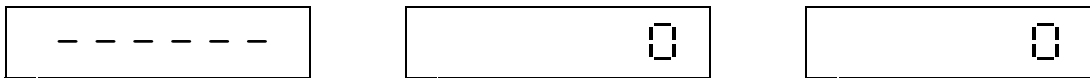

3. The scale will enter into counting mode after stable

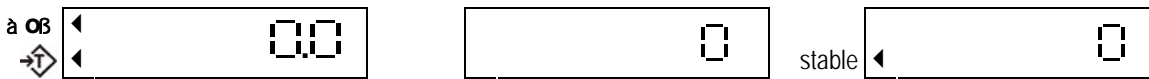

Clear off the tare value

Mode 1: After removing the object together with packaging container, weight column will display the negative value of packaging container. Press **TARE** key again to cancel the tare, and return to zero. The tare symbol “◀” will disappear.

Mode 2: After removing the object together with packaging container, weight column will display the negative value of packaging container. Press **ZERO** key again to cancel the tare, and return to zero. The tare symbol “◀” will disappear.

2-7 Pre-tare Function Operation

Func 09 (Pre-tare setting) is set up as 00. (No weight on platter)

1. No weight on platter



2. Press **TARE** key



3. Enter the known weight of packaging container

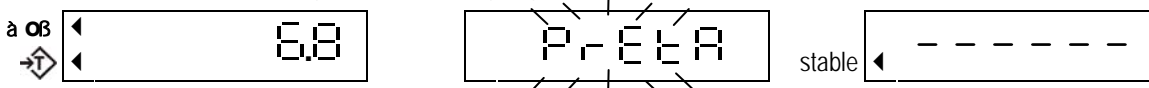

weight of packaging container entered

4. Press **TARE** key





Clear off Pre-tare value

After removing the object together with packaging container, weight column will display the negative weight value of the packaging container. Press **TARE** key once again to cancel the pre-tare value and return to zero. Then the tare and pre-tare symbol “◀” will disappear.

Recall Pre-tare value

1. Press **Q'TY PRSET** key, and then press **TARE** key

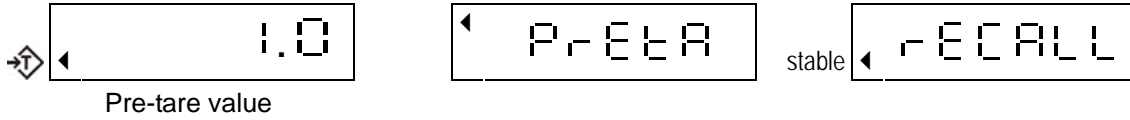

Pre-tare value

2. After displays pre-tare value about 5 seconds, it automatically returns to the weighing mode



(Recall pre-tare value function and clear function are not available for **Standard keypad models**.

2-8 Accumulation

- (The accumulation counts are up to 99 counts, but the total quantity column is at most 6 digits.
- (Users can not do positive accumulation and negative accumulation at the same time.

2-8-1 Quantity Accumulation

1. Place an object on platter

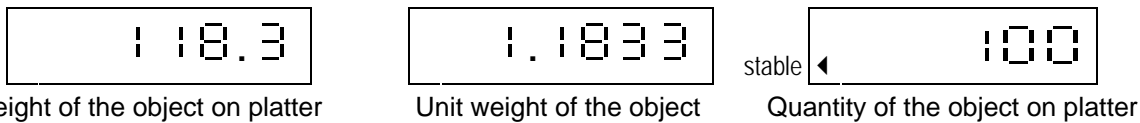

Weight of the object on platter

Unit weight of the object

Quantity of the object on platter

2. Press **M+** key

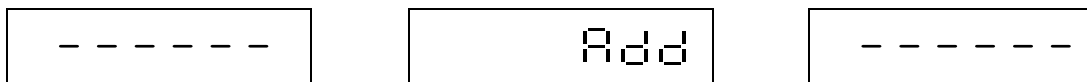

3. After scale is stable

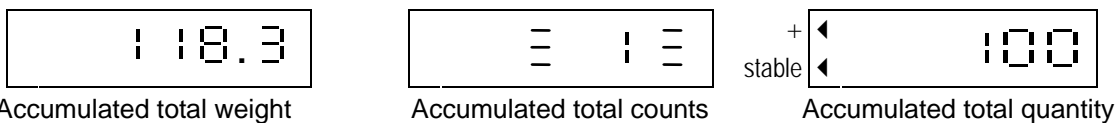

Accumulated total weight

Accumulated total counts

Accumulated total quantity

4. After about 3 seconds, scale returns to counting mode

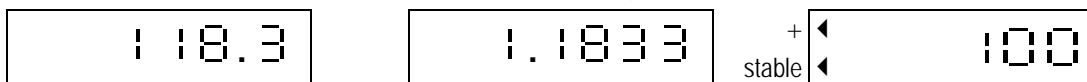

Weight of the object on platter

Unit weight of the object

Quantity of the object on platter

Recall quantity accumulation

While weight column displays 0, press **M+** key to recall the accumulated data

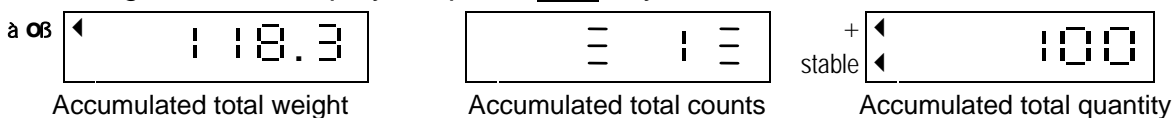

Accumulated total weight

Accumulated total counts

Accumulated total quantity

Clear off the accumulated quantity value

Press **MC** key to clear off the accumulated value in the memory, and then accumulation symbol “◀” will disappear.



2-8-2 Weight Accumulation

1. Place an object on platter when unit weight displays 0

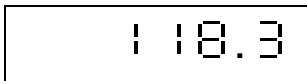

Weight of the object on platter

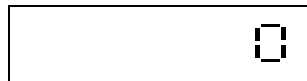

stable

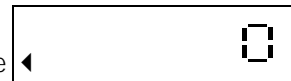

2. Press **M+** key

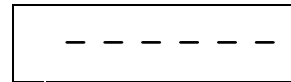
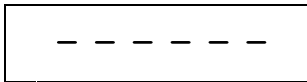

3. After scale is stable

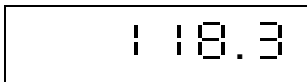

Accumulated total weight

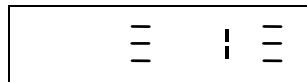

Accumulated total counts

+ stable



4. After about 3 seconds, scale returns to weighing mode

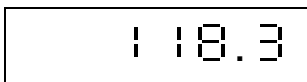

Weight of the object on platter



+ stable



Recall weight accumulation value

While weight column displays 0, press **M+** key to recall the accumulated data

a oB

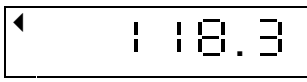

Accumulated total weight

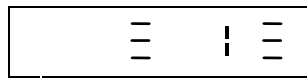

Accumulated total counts

+ stable



Clear off the accumulated weight value

Press **MC** key to clear off the accumulated weight in the memory, and then the accumulation symbol "◀" will disappear.

2-9 Quantity Preset

It's available to pre-set the upper limit of quantity in counting mode. If the counts are over the limit, the beeper makes warning sounds, and the weight column displays flashing "– 9E9 –"

Upper limit of preset quantity (Non-standard keypad)

1. Whether there is an object on platter or not, press **Q'TY PRESET** key. Press **SAMPLE** key, select "Quantity Preset" mode (Press **UNIT WEIGHT** key to select "Weight Preset" mode)

a oB

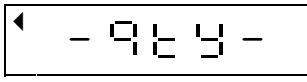

stable



Previous preset value

2. Enter the upper limit intended (Press **CE** key to modify the value entered)

a oB

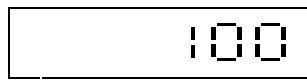
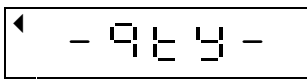

Upper limit entered

stable

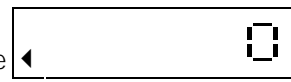

3. Press **SAMPLE** key (Press **CE** key to modify the value entered)

a oB

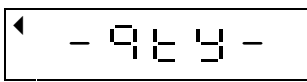

stable



4. press **Q'TY PRESET** key, the scale return to the counting mode

a oB



stable





Clear off the pre-set upper limit

To clear the pre-set upper limit of quantity or weight, please follow the above-mentioned operation steps. When entering the pre-set value, please enter “0” instead.

- (When switching to “weight preset” mode or “quantity preset” mode, previous preset value will be deleted automatically.
- (If it is standard keypad, use number keys to enter number and then press **Q'TY PRESET** key to finish the setting; If to clear off the pre-set upper limit, press **PRESET CE** key.

2-10 Weight Preset

It's available to pre-set the upper limit of weight. If the weights are over the limit, the beeper makes warning sounds, and the weight column displays flashing “-UPSt-”

Upper limit of preset weight

- Whether there is an object on platter or not, press **Q'TY PRESET** key. Press **UNIT WEIGHT** key to select “Weight Preset” mode (Press **SAMPLE** key to select “Quantity Preset” mode)

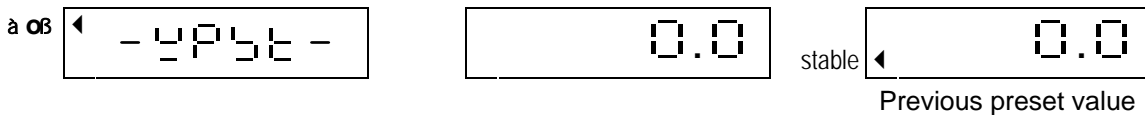

- Enter the upper limit intended (Press **CE** key to modify the value entered)

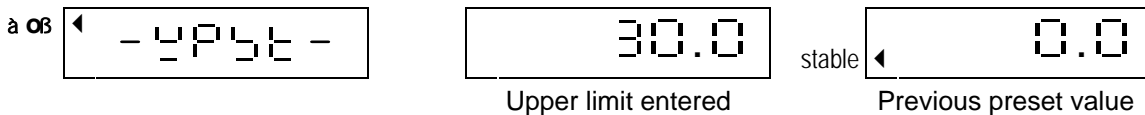

- Press **UNIT WEIGHT** key (Press **CE** key to modify the value entered)



- press **Q'TY PRESET** key, the scale return to the counting mode

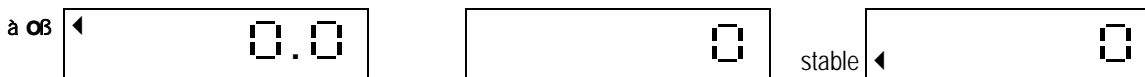

Clear off the pre-set upper limit

To clear the pre-set upper limit of quantity or weight, please follow the above-mentioned operation steps. When entering the pre-set value, please enter “0” instead.

- (When switching to “weight preset” mode or “quantity preset” mode, previous preset value will be deleted automatically.

2-11 ID Input

Press **ZERO** key, and the screen displays “- - - - -”. Press **0** key before it disappears.



Enter ID with number keys

ID could be set up to 12 digits. They can be numbers (0~9), English letters (A~Z), or _

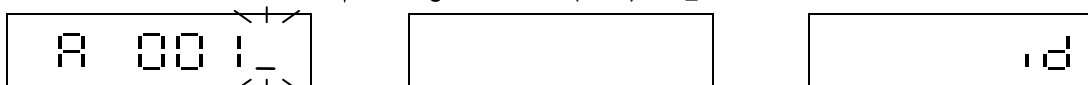

Press **MC** key to confirm

Press **<** key to quit setting

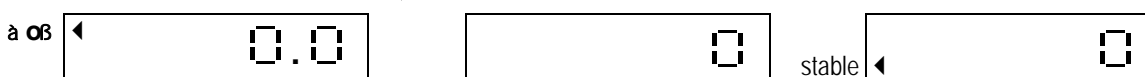



2-12 Item Input

Press **ZERO** key, and the screen displays “- - - - -”. Press **2** key before it disappears.

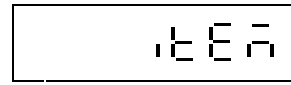

Enter Item with number keys

Item could be set up to 12 digits. They can be numbers (0~9), English letters (A~Z), or _

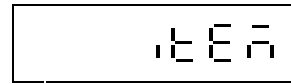
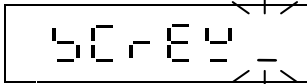

Press **MC** key to confirm

Press **<** key to quit setting

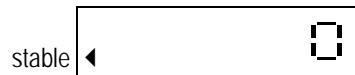
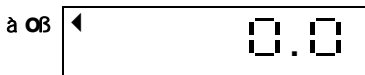

- (ID & ITEM are applied in FIX FORMAT or FREE FORMAT.
- (ID & ITEM could be set up to 12 digits. They can be numbers (0~9), English letters (A~Z), or _.
- (Entering numbers/English letters: Press number key and the digit flashes. Press the same key, and the display shows the number/English letter in cycle. When the entered number/English letter flashes for 2 seconds, the setting will be confirmed and moved to the right place by 1 digit. For example: Press **1** key continuously, and the screen displays 1,P,Q,R,S flashing in cycle.(If to enter too many numbers, please enter _ to clear superfluous numbers.)
- (If ID & ITEM are not saved in unit weight preset, the data will be cleared after power off.

< ⇒ Exit

CE ⇒ Move cursor leftward

TARE ⇒ Move cursor rightward

MC ⇒ Enter

2-13 Unit Weight Preset

- (The preset data could be saved in up to 50 addresses
- (Each address contains: € unit weight , pre-tare f ID and , ITEM

2-13-1 Pre-set Unit Weight Operation (Read-in)

(Use number keys to enter the unit weight. (The value is 0 or blank without setting)

Press **U.W. PST** key

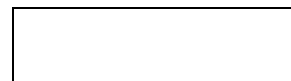
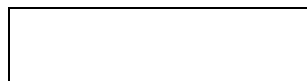
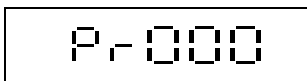

Press **U.W. PST** key again

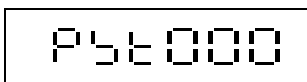

Press number keys to select 1 of 50 addresses for saving the data. If it is over 50, Please re-enter.

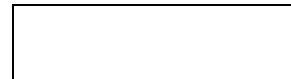
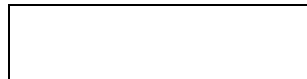
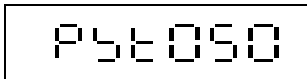

Press **U.W. PST** key



2-13-2 Pre-set Unit Weight Saving Operation (Read-out)

Press **U.W. PST** key again

P-000

Use number keys to enter preset group that you want. If it is over 50, Please re-enter.

P-050

Press **U.W. PST** key again to read-out the data you saved. If the data is blank, it shows NULL.

(While read-in or read-out, if the waiting time is over 10 seconds, the scale returns to weighing mode automatically. Press **CE** key to cancel the read-in and read-out.



Chapter 3 External Calibration Setting

After starting the machine and it returns to zero, press **ZERO** key and the screen displays "-----". Then press **<** key to enter external calibration function setting mode. The weight column displays **01 Fnc**.

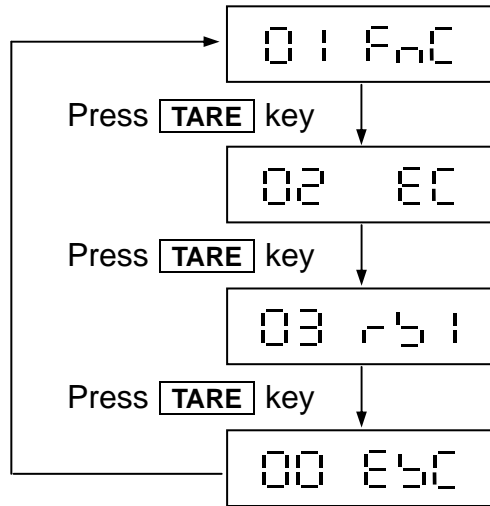

- 01 Fnc ⇒ External Function Setting
- 02 EC ⇒ External Weight Calibration and G Value Calibration
- 03 rbi ⇒ RS-232 and Serial Printer Setting
- 00 E5C ⇒ Exit the Setting

- <** ⇒ Exit
- CE** ⇒ Move cursor leftward
- TARE** ⇒ Move cursor rightward
- MC** ⇒ Enter

Press **TARE** key

3-1 External Function Setting 01 Fnc

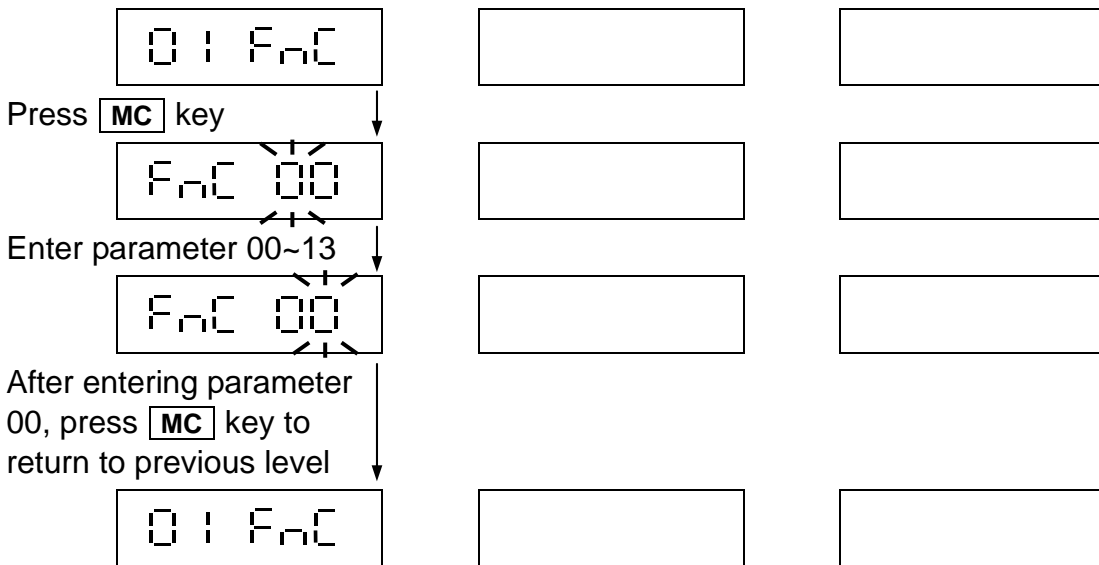

- | | |
|---|--|
| Fnc 00 ⇒ Return to previous level | Fnc 07 ⇒ "Zero" track range |
| Fnc 01 ⇒ Backlight mode setting | Fnc 08 ⇒ Accumulation ending mode |
| Fnc 02 ⇒ Auto. power off setting | Fnc 09 ⇒ Pre-tare mode |
| Fnc 03 ⇒ Stable range setting for quantity sampling | Fnc 10 ⇒ "Beeper" output setting for quantity limit |
| Fnc 04 ⇒ Auto. unit weight average | Fnc 11 ⇒ Accumulation acceptable condition setting 1 |
| Fnc 05 ⇒ A/D sampling speed | Fnc 12 ⇒ Accumulation acceptable condition setting 2 |
| Fnc 06 ⇒ "Zero" display range | Fnc 13 ⇒ Combination key Setting |

(For OIML and NTEP approval models, the parameter of Fnc 06~13 can not be modified.



3-1-1 Backlight Mode Setting F_nC 01

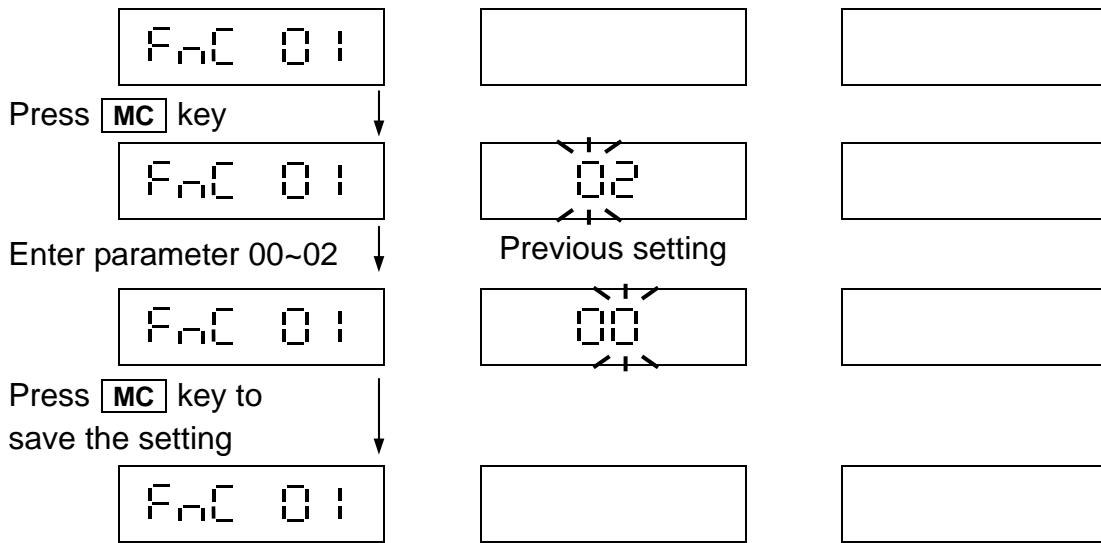

Default Setting: 02 (No backlight)

00 ⇒ Backlight is always on.

01 ⇒ While weighing (weight is higher than 10d) or pressing any key, backlight be turned on automatically. The backlight is turned off automatically when the scale is idle for 10 minutes. (d=division)

02 ⇒ No backlight.

(When turning on, the backlight mode is the same as previous setting.

3-1-2 Auto. Power-off Setting F_nC 02

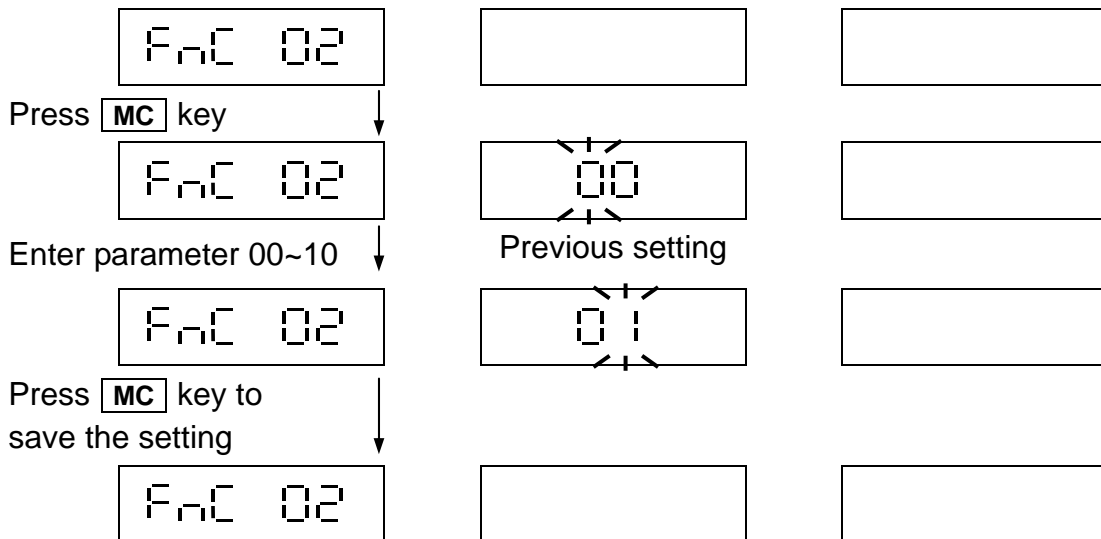

Default Setting: 00

00 ⇒ Auto. Power-off function is off.

01 ~ 10 ⇒ The scale to be automatically power off after the scale in not in use for 1~10 minutes. (If intended to operate continuously, please restart the scale again.)

(It can be set up to 10 minutes at most.

<	⇒ Exit
CE	⇒ Move cursor leftward
TARE	⇒ Move cursor rightward
MC	⇒ Enter

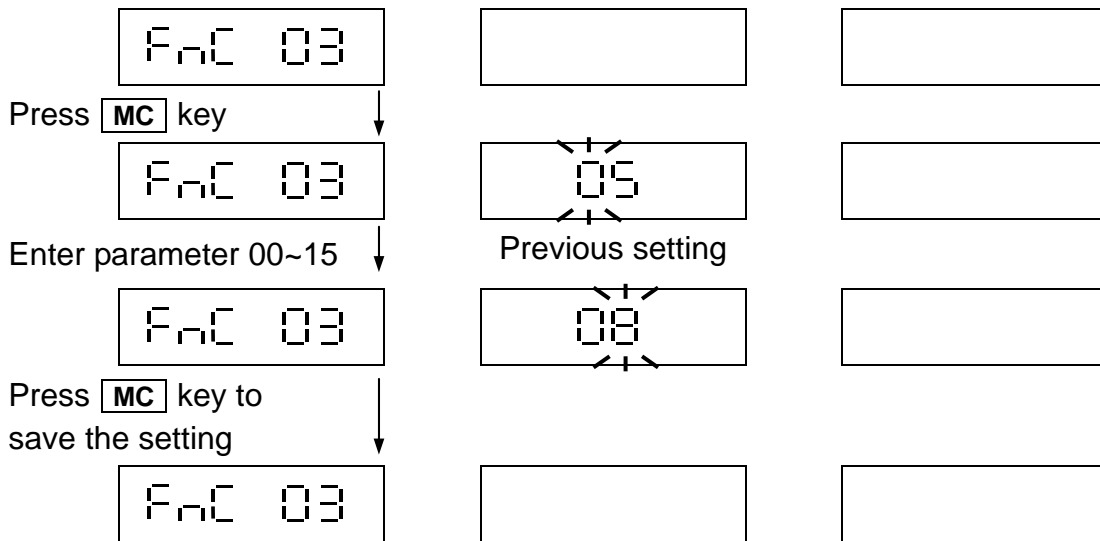
**3-1-3 Stable Range Setting for Quantity Sampling F_nC 03**

Default Setting: 08

While quantity sampling, the scale will indicate a stable reading and error is within $\pm 8d$ internal value. (d=division)

The higher value makes the sampling faster, but less accurate.

The smaller value makes the sampling slower, but more accurate.

(It can't be shifted after sampling, only when the unit weight is cleared in Brazil version.

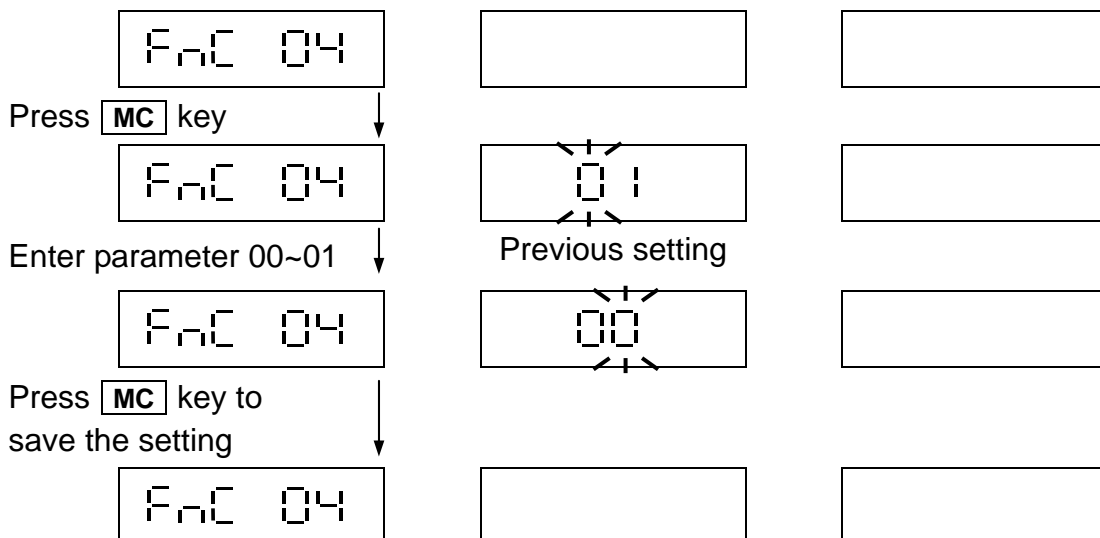
3-1-4 Auto. Average Unit Weight Setting F_nC 04

Default Setting: 01

00 ⇒ Auto. average unit weight function is off. (Press **SAMPLE** key for manual unit weight calibration)

01 ⇒ Auto. average unit weight function is on.

Condition: Auto. unit weight calibration performs when the measured sampling number increase greater than 10% but less than 100% of previous sampling number.

<	⇒ Exit
CE	⇒ Move cursor leftward
TARE	⇒ Move cursor rightward
MC	⇒ Enter



3-1-5 A/D Sampling Speed Setting F_nC 05

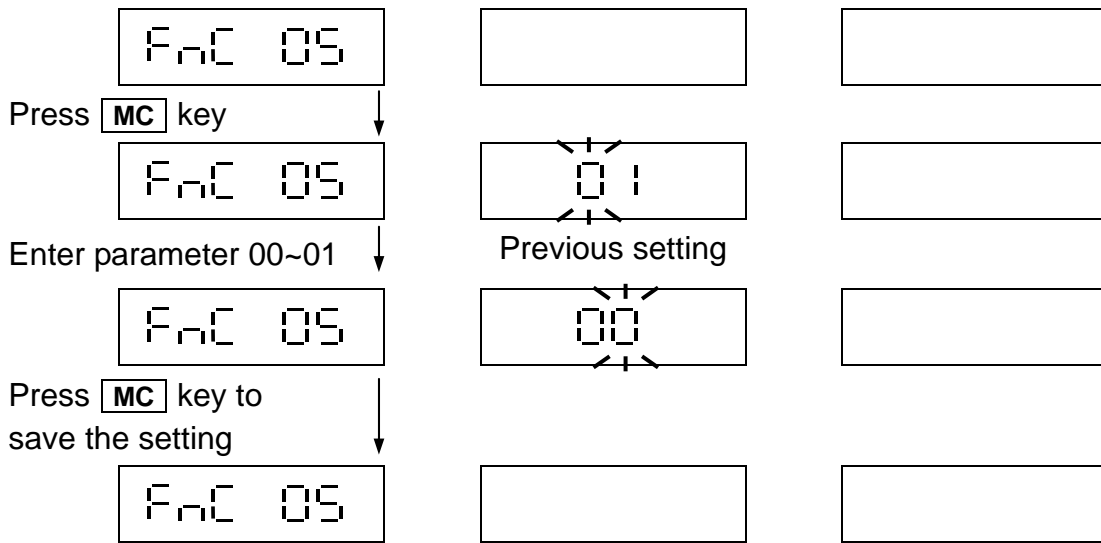

Default Setting: 0 1

00 ⇒ Low speed is about 7.5 Hz. (Weighing reflection is slow but relatively stable)

0 1 ⇒ Fast speed is about 15 Hz. (Weighing reflection is fast but relatively unstable)

3-1-6 Zero Display Range Setting F_nC 06

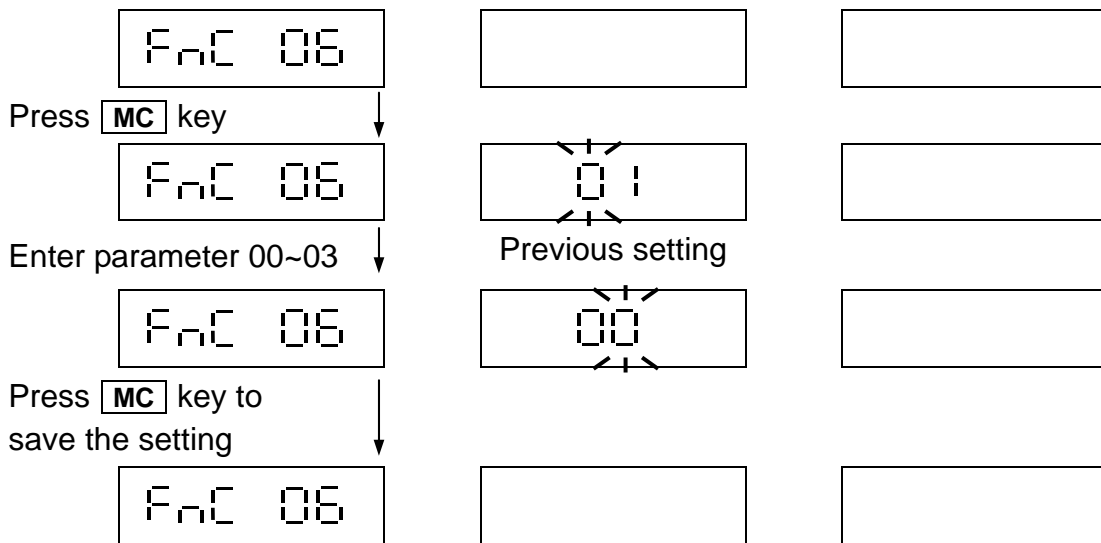

(Default setting: 00

00 ⇒ Display all

0 1 ⇒ Zero range ±1 bit will not display division, and displays zero instead.

0 2 ⇒ Zero range ±2 bit will not display division, and displays zero instead.

0 3 ⇒ Zero range ±3 bit will not display division, and displays zero instead.

If 0 3 is set, when setting pre-tare value, it can not be less or equal to ±3 bits external value, and so on. When the weight is over 1/3 full capacity and return to 0, this function is activated.

(The approval model is disabled.

- ⇒ Exit
- ⇒ Move cursor leftward
- ⇒ Move cursor rightward
- ⇒ Enter



3-1-11 Accumulation Acceptable Condition Setting 1 F_nC 11

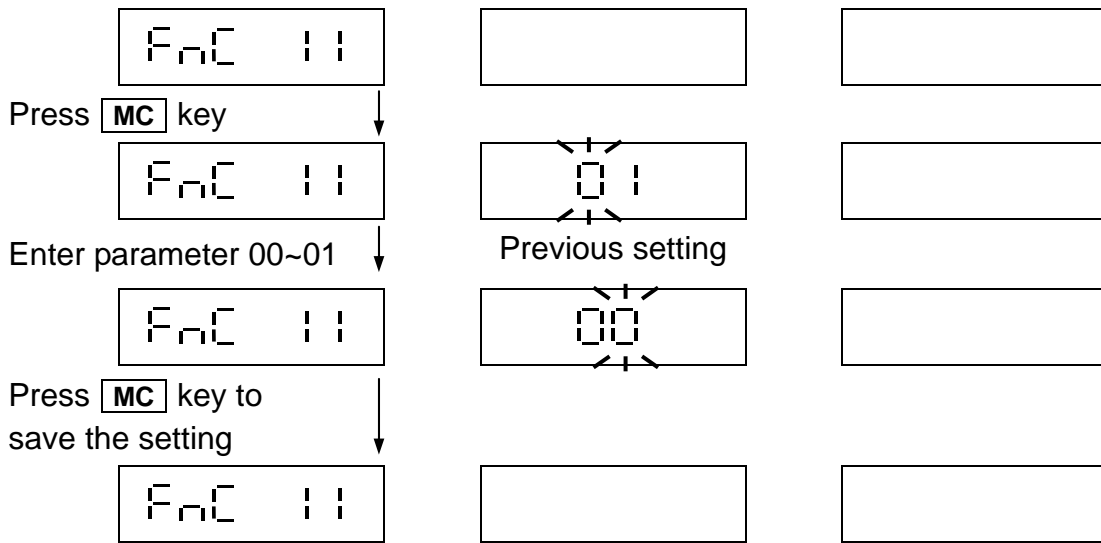

Default setting: 00.

00 ⇒ The scale accepts accumulation only when being stable.

01 ⇒ The scale accepts accumulation no matter its being stable or not.

(OMIL and NTEP approval models are disabled.

3-1-12 Accumulation Acceptable Condition Setting 2 F_nC 12

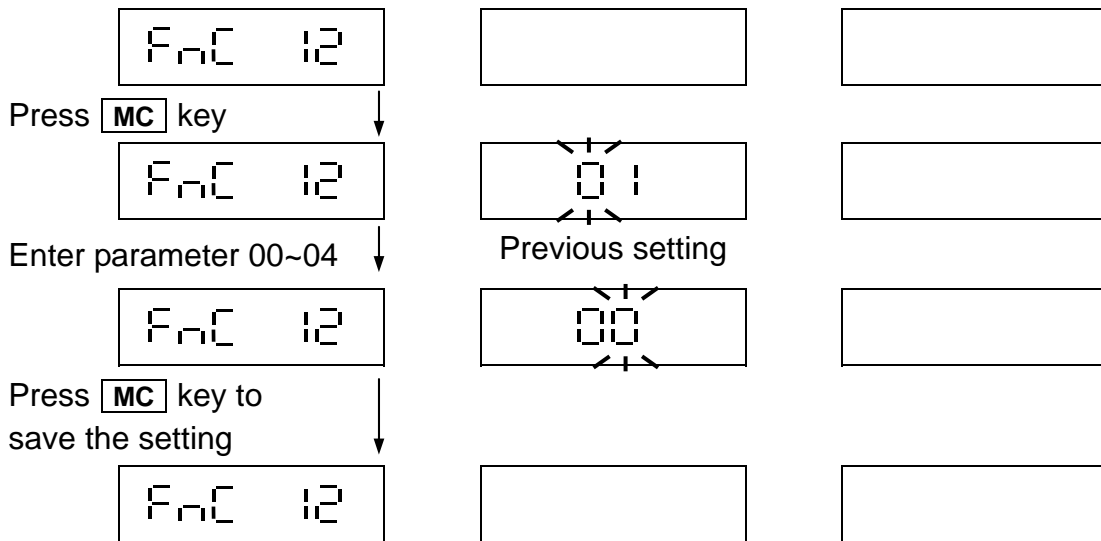

Default Setting: 00

00 ⇒ Only when the weight returns to zero, the scale accepts the next accumulation value. If the weight is near zero band, please adjust the setting in r-5 1 0 1.

01 ⇒ The weight is no need to return to zero, the scale accepts the next accumulation value.. That means when no weight on platter, the weight can be accumulated continuously.

02 ⇒ The weight must return to zero (gross = 0), and the scale can accept the next accumulation value.

03 ⇒ Press **M+** key not to accumulate the value, at the same time, RS-232 transmits the data.

04 ⇒ The weight should be less than 1/4 d of zero point, and the scale can accept the next accumulation value.

(OMIL and NTEP approval models are disabled.



3-1-13 Combination Key Setting F_nC 13

Combination key represents **kg/lb** key or **UNIT WEIGHT PRESET** key. This key contains 2 functions: € Unit switching , 50 sets for unit weight preset

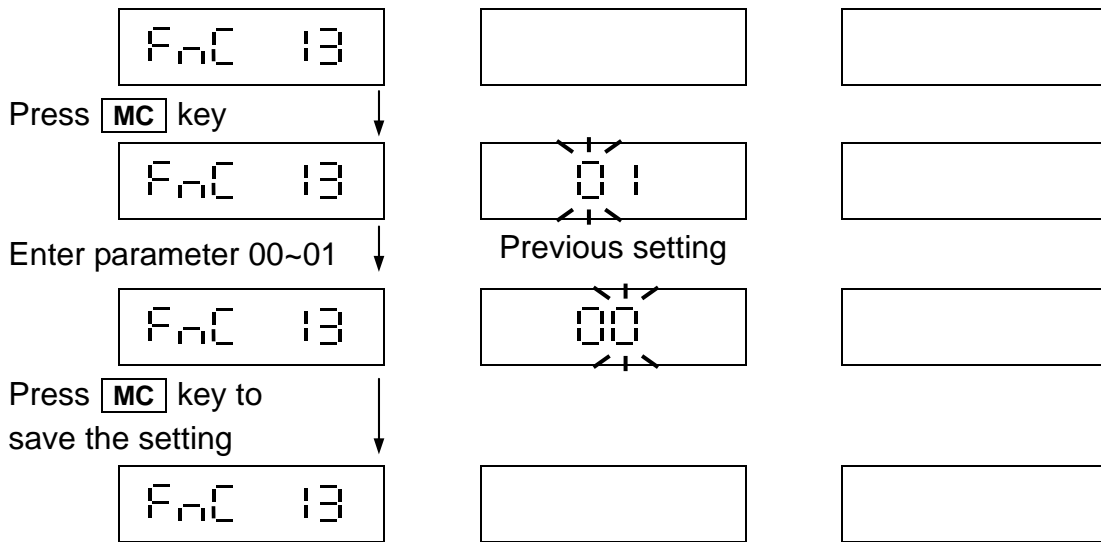

Default setting: 00.

00 ⇒ Press the combination key once to select unit (priority function).

Press the combination key for 3 seconds to preset unit weight (minority function).

0 1 ⇒ Press the combination key once to preset unit weight (priority function).

Press the combination key for 3 seconds to select unit (minority function).

(OMIL and NTEP approval models are disabled.

- ⇒ Exit
- ⇒ Move cursor leftward
- ⇒ Move cursor rightward
- ⇒ Enter



3-2 RS-232 and Serial Printer Setting 03 r51

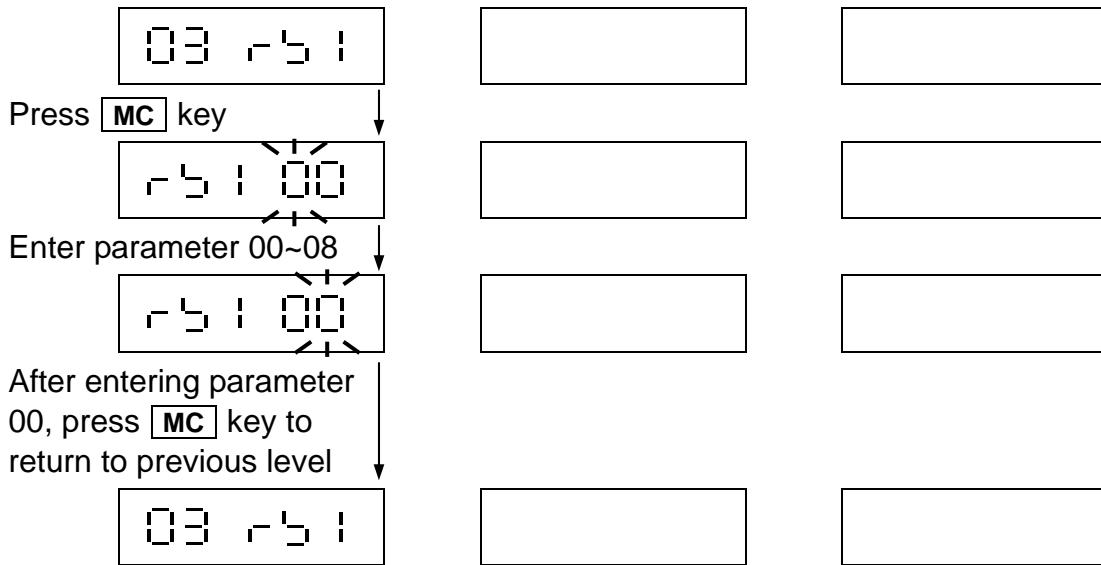

- r51 00 ⇒ Return to previous level
- r51 01 ⇒ Baud rate setting
- r51 02 ⇒ Communication protocol setting
- r51 03 ⇒ Output data format setting
- r51 04 ⇒ Output count setting per second in continuous transmission
- r51 05 ⇒ Operation mode setting
- r51 06 ⇒ Continuous transmission output condition setting
- r51 07 ⇒ Zero band setting for auto. transmission
- r51 08 ⇒ Weight band setting for auto. transmission setting

3-2-1 Baud Rate Setting r51 01

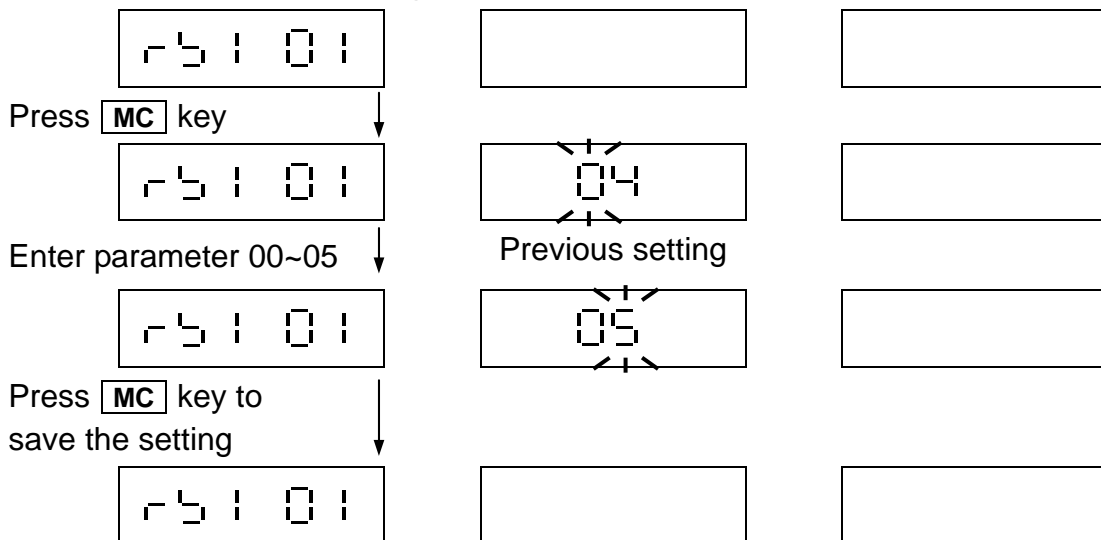

Default Setting: 04 (9,600 bit/sec)

- 00 ⇒ 600 bit/sec
- 01 ⇒ 1,200 bit/sec
- 02 ⇒ 2,400 bit/sec
- 03 ⇒ 4,800 bit/sec
- 04 ⇒ 9,600 bit/sec
- 05 ⇒ 19,200 bit/sec

- <** ⇒ Exit
- CE** ⇒ Move cursor leftward
- TARE** ⇒ Move cursor rightward
- MC** ⇒ Enter

(If there is free form device, it is 9600 bits/sec transmit.



3-2-2 Communication Protocol Setting r 5 | 02

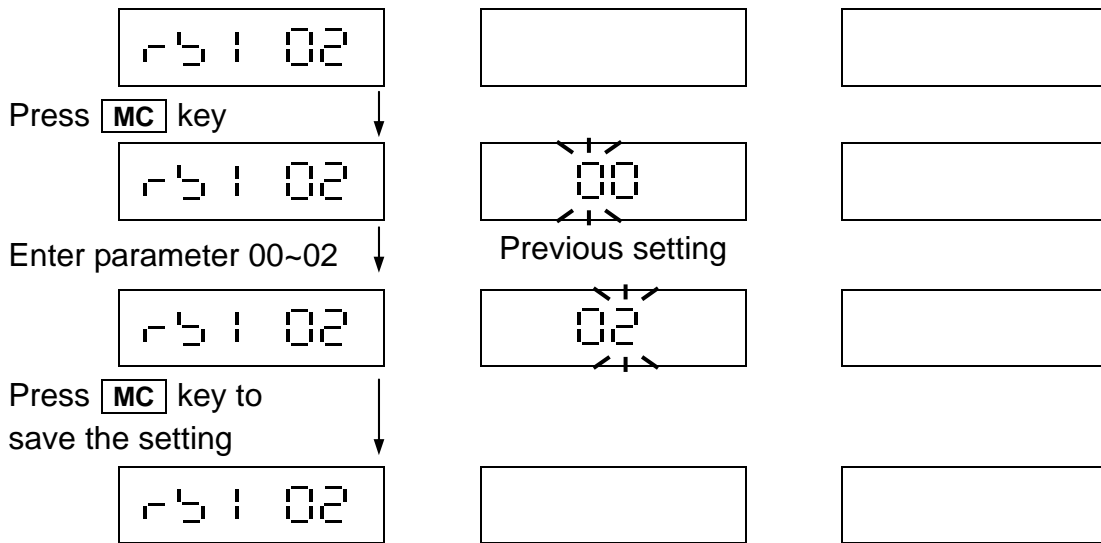

Default Setting: 00 (N, 8, 1)

00 ⇒ N, 8, 1

01 ⇒ E, 7, 1

02 ⇒ O, 7, 1

(If there is free form device, it is 9600 bits/sec transmit.

3-2-3 Output Data Format Setting r 5 | 03

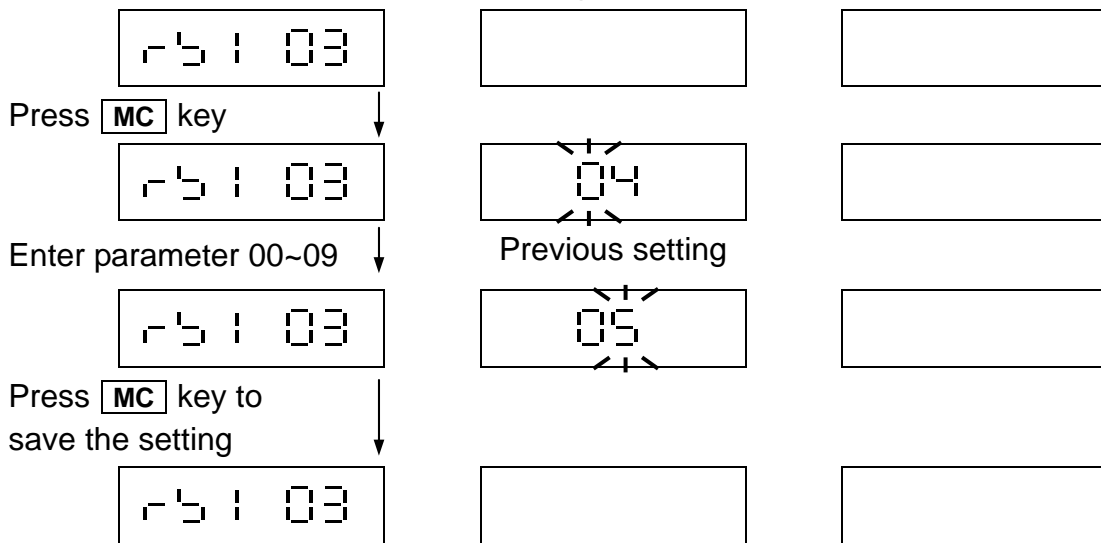

Default Setting: 00 (Fixed format 1)

00 ⇒ Fixed format 1 (details see following page)

01 ⇒ Fixed format 2 (details see following page)

02 ⇒ Reserved

03 ⇒ Same as screen display (general format)

04 ⇒ Same as screen display (general format)

05 ⇒ Gross weight (general format)

06 ⇒ Net weight (general format)

07 ⇒ Tare (general format)

08 ⇒ Fixed format 3 (details see following page)

09 ⇒ Fixed format 4 (details see following page)

(Please see "Appendix 1" for output format.

(If there is free form device, the setting will be fixed as 02 ⇒ Reserved.

- < ⇒ Exit
- CE ⇒ Move cursor leftward
- TARE ⇒ Move cursor rightward
- MC ⇒ Enter



Fixed format is described as following:

Fixed format 1 “Press **M+** key to print”

NO.	3	
G	2.480	kg
N	2.000	kg
T	0.080	kg
PT	0.400	kg
U/W	1.6003	g
Q	1250	pcs

Fixed format 2 “Press **M+** key to print”

ID:	xxxxxxx	xxxxx
ITEM:	xxxxxxx	xxxxx
NO.	3	
G	2.480	kg
N	2.000	kg
T	0.080	kg
PT	0.400	kg
U/W	1.60	g
	03	
Q	1250	pc s

(If the format in rS1 03 is set that press **M+** or **MC** key to print and the transmission format in rS1 05 is set as continuous or automatic transmission, some content printed out is meaningless.

Fixed format 3 “Press **M+** key to print”

NO.	1
N/W	0.500
U/W	1.00013
PCS	500

Fixed format 4 “continuous or auto. transmission”

N/W	0.500
U/W	1.00013
PCS	500

Fixed format 1,2 “Press **MC** key to print”

(Print out total accumulation data and clear data in memory)

=====

T/N	3
T/W	1500 kg
T/Q	300 pcs

Fixed format 3 “Press **MC** key to print”

(Print out total accumulation data and clear data in memory)

=====

T/N	3
T/W	1500
T/A	300

NO. ⇒ Number of Counts Q ⇒ Quantity T ⇒ Tare PT ⇒ Pre-Tare
 G ⇒ Gross Weight N ⇒ Net weight U/W ⇒ Unit weight
 T/N ⇒ Total Number of Counts T/W ⇒ Total weight T/Q ⇒ Total quantity
 ID: 12 digits (max.) ITEM: 12 digits (max.)



3-2-4 Output Count Setting $r5 : 04$

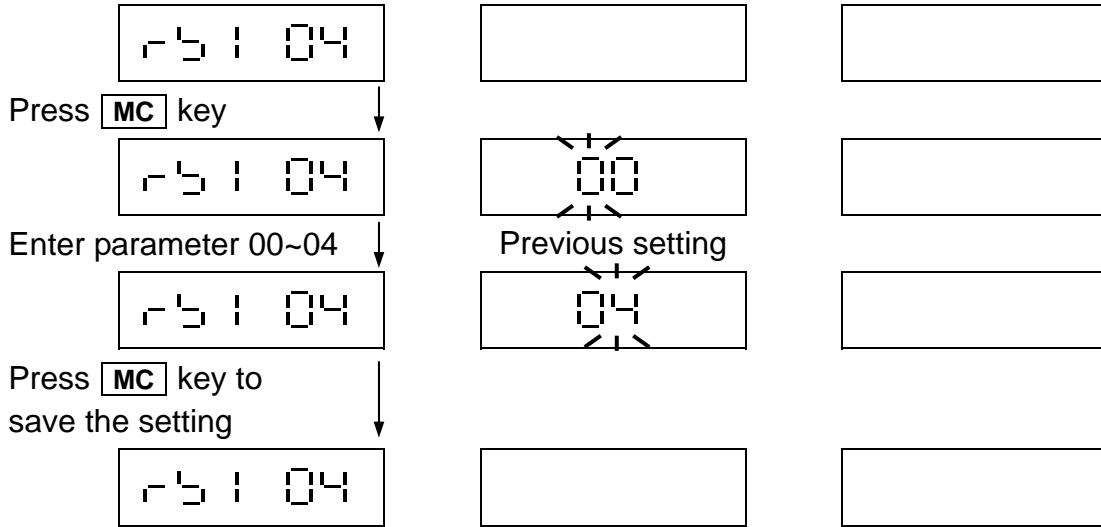

Default Setting: 00 (1 count/sec)

00 ⇒ 1 count/sec

01 ⇒ 2 counts/sec

02 ⇒ 4 counts/sec

03 ⇒ 8 counts/sec

04 ⇒ More than 8 counts/sec

- (If parameter in $r5 : 03$ is set as 00 or 01, it may not be able to reach transmit counts due to too long distance.
- (If parameter in $r5 : 03$ is set as 02, it is not capable of continuous transmission mode.
- (If parameter in $r5 : 03$ is set as 03 ~ 07, it is capable of continuous transmission mode.

3-2-5 Operation Mode Setting $r5 : 05$

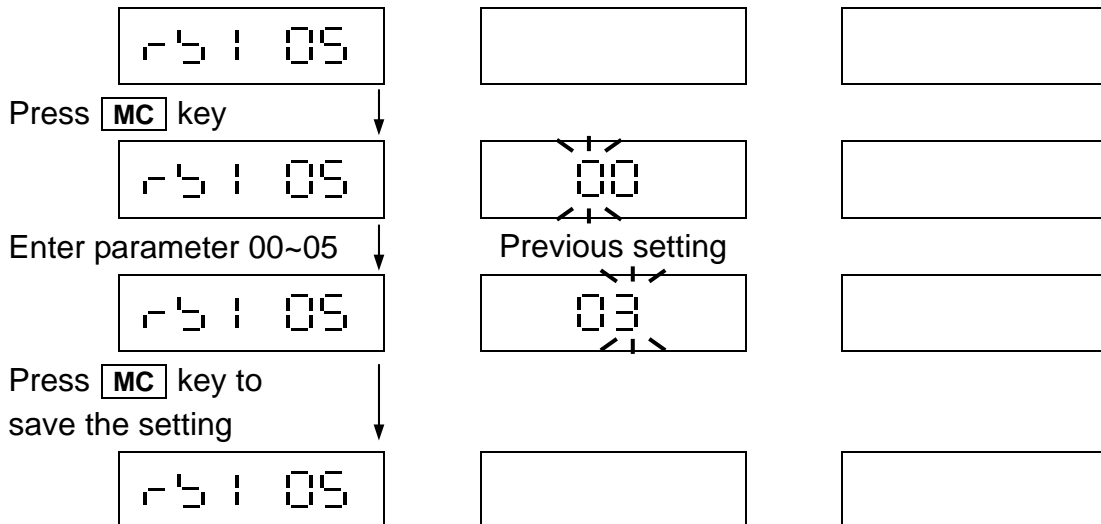

Default Setting: 03

00 ⇒ Command mode

01 ⇒ Continuous transmission + command mode

02 ⇒ Auto. transmission + command mode

03 ⇒ Manual transmission + command mode

04 ⇒ No RS-232 transmission

05 ⇒ ZEBERA PRINTER output format

[<] ⇒ Exit

[CE] ⇒ Move cursor leftward

[TARE] ⇒ Move cursor rightward

[MC] ⇒ Enter

- (If parameter in $r5 : 03$ is set as 02, the setting in $r5 : 05$ is fixed as Manual transmission
- (If there is free form device, the setting will be fixed as 03.
- (Please see "Appendix 1" for command mode format.



For example:

TN = 3
 TW = 2,395 kg
 TA = 23937

F	R	"	5	2	0	T	"	<LF>										
?	<LF>																	
SP	SP	SP	SP	SP	3	<LF>												
SP	2	,	3	9	5	<LF>												
SP	2	3	9	3	7	<LF>												
0	0	0	0	0	3	0	0	2	3	9	5	0	2	3	9	3	7	<LF>
P	1	,	1	<LF>														

<LF> = 0x0A (line feed) SP = 0x20 (Blank)

3-2-6 Continuous Transmission Output Condition Setting r 5 | 06

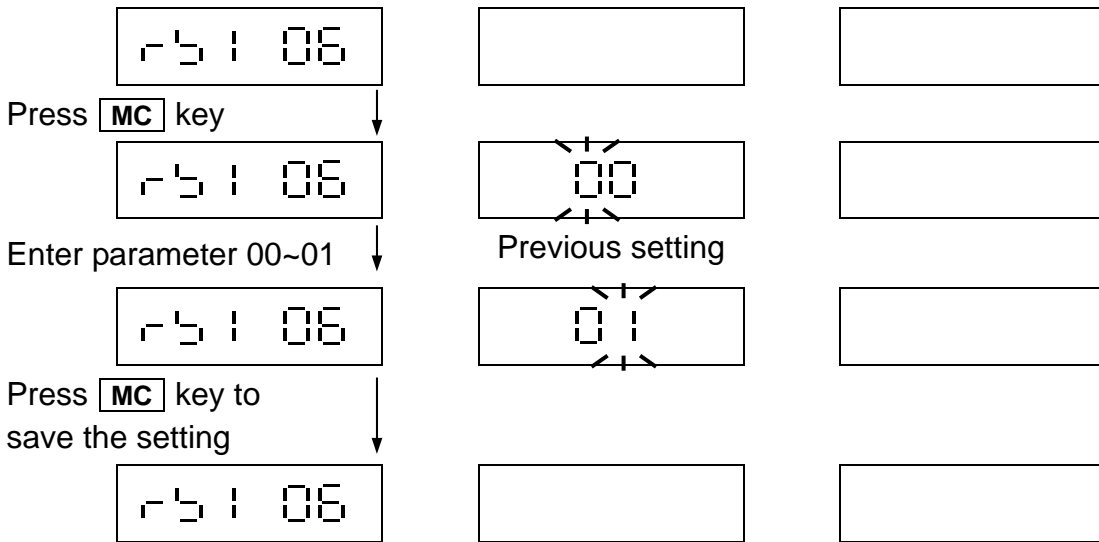

Default Setting: 00 (Output all)
 00 ⇒ Output all
 01 ⇒ No output under OL or unstable condition

(The setting in r 5 | 06 will be effective only when the setting is set as 0 1 in r 5 | 06

- < ⇒ Exit
- CE ⇒ Move cursor leftward
- TARE ⇒ Move cursor rightward
- MC ⇒ Enter



3-2-7 Zero Band Setting for Auto. Transmission $r5107$

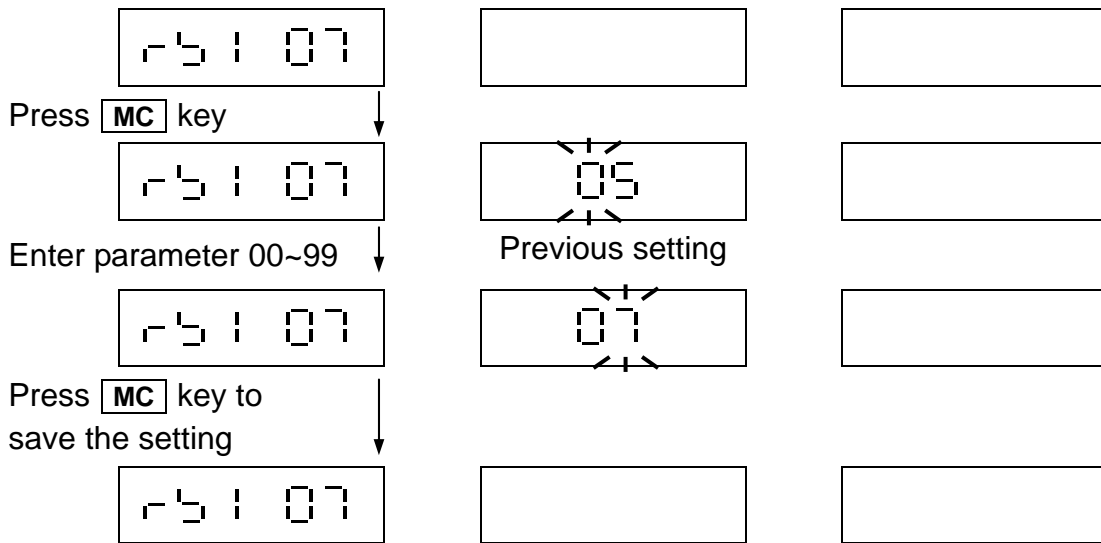

Default Setting: 05 (External value "5d")

00 ⇒ External value "0d"

01 ⇒ External value "1d"

⋮

99 ⇒ External value "99d"

(The range setting in $r5107$ is related to accumulation acceptable condition in $Fnc12$)

3-2-8 Weight Band Setting for Auto. Transmission $r5108$

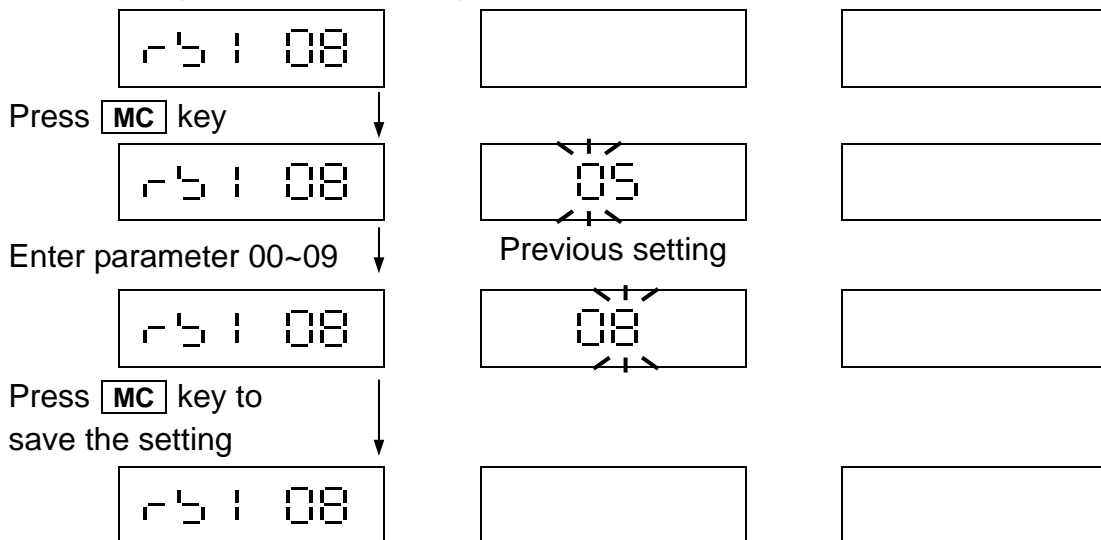

Default Setting: 05 (External value "5d")

00 ⇒ External value "0d"

01 ⇒ External value "1d"

⋮

99 ⇒ External value "99d"

(The setting in $r5105$ should be set as 02.)

- ⇒ Exit
- ⇒ Move cursor leftward
- ⇒ Move cursor rightward
- ⇒ Enter



Appendix 1 RS-232 Full Duplex Format

Table 1 Command Format

Command Format A

Host	Command	Slave	Command
MZ	Return to zero	CP	Clear off pre-tare value
MT	Tare	CT	Clear off tare value
AT	Current net weight accumulation & count plus 1	DT	Clear off accumulated data and counts
SC	Set continuous transmission mode	SA	Set automatic transmission mode.
SM	Set manual transmission mode	SO	Set command mode
UA	Shift to first unit	UB	Shift to second unit
%	Cease continuous transmission mode and enter into command mode		

Command Format B

Host	Command	Slave	Data
RW	Read current displaying weight	RB	Read current displaying weight(simple)
RG	Read gross weight	RT	Read tare
RN	Read net weight	RI	Read net weight (simple)
RH	Read gross weight (simple)	RE	Read pre-tare (simple)
RU	Read unit weight (simple)	RD	Read accumulated quantity (simple)
RC	Read accumulated counts (simple)	RI	Read tare (simple)
Rf	Read pre-set name (ITEM)	Rk	Read accumulated weight (simple accumulation format)
Rg	Read ID#	Rh	Read weighing unit
RQ	Read quantity (simple)	Ri	Read unit weight unit
Re	Read PLU#		

(Add % before italic and magnified letter to read continuously.
Add # before italic and magnified letter to read stable value only.

(Two formats (AB) mentioned above are all RS-232 full duplex. If the slave terminal receives the below-listed messages, it represents Error condition.

E1: Wrong command E2: Wrong format (wrong parameter) E3: Mismatch proceeding condition

(If read PLU command, PUL of N group is NULL or unit weight is re-entered, otherwise read PUL command and return value is 255.

Command Format C

According to the command format to modify ID,ITEM ,PT, UW :

ID:

S	I	A	A	A	A	A	A	A	A	A	A	A	A	A	CR	LF
---	---	---	---	---	---	---	---	---	---	---	---	---	---	---	----	----

ITEM:

S	C	A	A	A	A	A	A	A	A	A	A	A	A	A	CR	LF
---	---	---	---	---	---	---	---	---	---	---	---	---	---	---	----	----

PT:

S	T	0	0	1	.	0	0	0	CR	LF
---	---	---	---	---	---	---	---	---	----	----

UW:

S	T	0	0	1	.	0	0	0	CR	LF
---	---	---	---	---	---	---	---	---	----	----



Description:

1. 2 previous code is command code (must be capital letter), A is 0-9 or A-Z. Other symbol is unacceptable (because it can't be showed on LCD).
2. Decimal point of PT or UW can be moved.

Table 2 Output Format

General Format

Gross weight	S	T	,	G	S	,	+	1	.	2	3	.	4	5	6	l	b	o	z	CR	LF		
Net weight	S	T	,	N	T	,	+	1	2	.	3	4	.	5	6	T	l	.	g				
Tare	S	T	,	T	R	,	+	0	1	2	.	3	4	5	6	SP	SP	k	g				
+ overload	O	L	,	G	S	,	+	SP	SP	SP	SP	SP	SP	SP	SP	SP	SP	SP	SP				
- overload	O	L	,	G	S	,	-	SP	SP	SP	SP	SP	SP	SP	SP	SP	SP	SP	SP				
Unstable	U	S	,	G	S	,	+	0	1	2	3	.	4	5	6	SP	SP	l	b				

Totally 21 bytes (including CR LF)

Simple Format (Price Computing, Counting)

ID#	0	0	0	0	0	0	0	0	0	0	0	2	CR	LF
Read preset name	SP	SP	SP	SP	SP	SP	SP	A	P	P	L	E		

Totally 14 bytes (including CR LF)

Simple Format

Read current weighing unit	0	CR	LF
Read current price computing unit	1		
Read current unit weight unit	2		

Totally 3 bytes (Including CR LF)

Simple Format (Price Computing, Counting, Weighing)

Gross weight	+	1	.	2	3	.	4	5	6	CR	LF		
Net weight	+	1	2	.	3	4	.	5	6				
Tare	+	0	1	2	.	3	4	5	6				
Pre-tare	+	0	1	2	.	3	4	5	6				
+ overload	+	SP	SP	SP	SP	SP	SP	SP	SP				
- overload	-	SP	SP	SP	SP	SP	SP	SP	SP				
Unstable	+	0	1	2	3	.	4	5	6				
Quantity	SP	1	2	3	4	5	6	7	8				
Unit weight	SP	1	2	3	.	4	5	6	7				
Accumulated counts	SP	0	0	0	0	0	0	0	1				
PLU#	SP	0	0	0	0	0	0	1	2				

Totally 11 bytes (including CR LF)

Simple Accumulation Format

Accumulated weight	SP	0	1	2	3	4	.	5	6	.	7	CR	LF		
Accumulated quantity	SP	0	1	2	3	4	5	6	7	8	9				
Accumulated weight + overflow	+	SP	SP	SP	SP	SP	SP	SP	SP	SP	SP				
Accumulated weight - overflow	+	SP	SP	SP	SP	SP	SP	SP	SP	SP	SP				

Totally 13 bytes (including CR LF)



Appendix 2 Fixed Format RS-232 Transmission Line Description

SCALE	→	RS-232 PRINTER
DB 9	→	DB 9
2TX	→	3TX
3RX	→	2RX
5GND	→	5GND

SCALE	→	PC
DB 9	→	DB 9
2TX	→	2TX
3RX	→	3RX
5GND	→	5GND

Serial Data Transfer / Receive Format

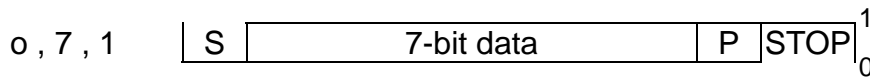
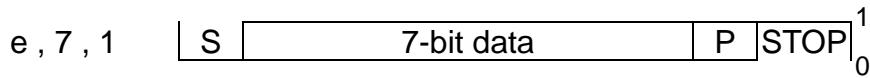
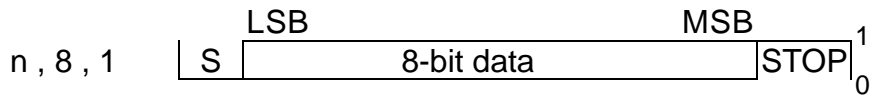

(S : Start bit STOP: Stop bit P : Parity bit



Appendix 3 ASCII Code Table

Symbol	ASCII Code	Symbol	ASCII Code	Symbol	ASCII Code
A	41H	a	61H	0	30H
B	42H	b	62H	1	31H
C	43H	c	63H	2	32H
D	44H	d	64H	3	33H
E	45H	e	65H	4	34H
F	46H	f	66H	5	35H
G	47H	g	67H	6	36H
H	48H	h	68H	7	37H
I	49H	i	69H	8	38H
J	4AH	j	6AH	9	39H
K	4BH	k	6BH	↵	0DH
L	4CH	l	6CH		
M	4DH	m	6DH		
N	4EH	n	6EH		
O	4FH	o	6FH		
P	50H	p	70H		
Q	51H	q	71H		
R	52H	r	72H		
S	53H	s	73H		
T	54H	t	74H		
U	55H	u	75H		
V	56H	v	76H		
W	57H	w	77H		
X	58H	x	78H		
Y	59H	y	79H		
Z	5AH	z	7AH		



Appendix 4 7-Segment Display Characters

Number	Display	Letter	Display	Letter	Display
0		A		N	
1		B		O	
2		C		P	
3		D		Q	
4		E		R	
5		F		S	
6		G		T	
7		H		U	
8		I		V	
9		J		W	
		K		X	
		L		Y	
°C		M		Z	