

Refrigerated Air Dryer

For Use in Southeast Asia

Applicable for the high-temperature environments of tropical regions

Can be used in high-temperature environments

Ambient temperature: Max. 45°C

Inlet air temperature : Max. 65°C

Dew point range : 3°C to 20°C

Air flow capacity * IDFC90-23,
Dew point of 10°C

9.2 m³/min (52% increase compared to the existing model)

Power supply voltage

Single-phase 230 VAC (50 Hz)



New The IDFC80 and IDFC90 series have been added!

IDFC □ **Series**



CAT.ES30-18C

High-temperature environment specification

Applicable to high-temperature environments in Southeast Asia

Operating conditions in Southeast Asia		IDFC Series	Existing model IDFA Series
Ambient temperature	Max. 45°C	Max. 40°C	
Inlet air temperature	Max. 65°C	Max. 50°C	
Power supply voltage	Single-phase 230 VAC 50 Hz	Single-phase 230 VAC 50 Hz	

Increased air flow capacity

Maximum dew point: 20°C

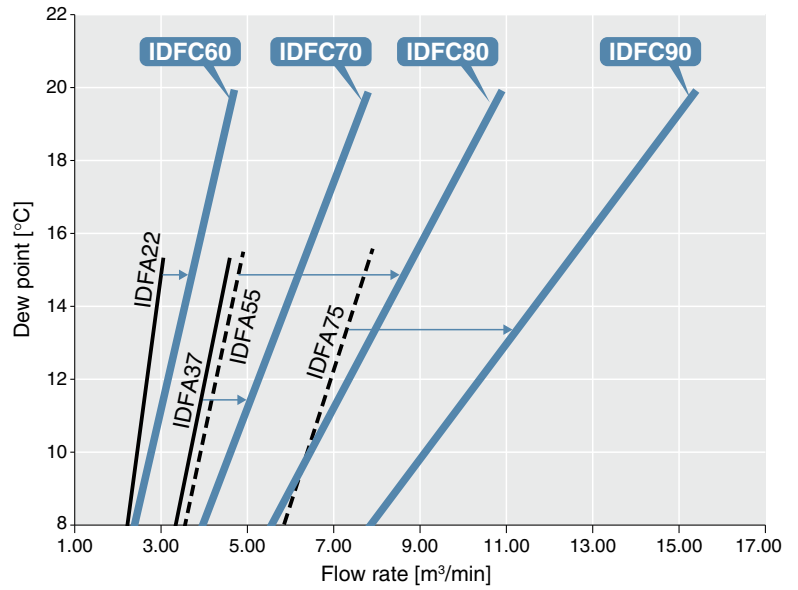

Suction state of compressed air: Flow rate at 32°C, Atmospheric pressure, and 75% relative humidity
 Operating conditions: Ambient temperature: 35°C,
 Inlet air temperature: 50°C,
 Inlet air pressure: 0.7 MPa

New stainless steel heat exchanger helps reduce the load of the compressor

Easier maintenance

- The red zone indicates an overload operation.

Can be used to check for high operating conditions
 Can notify you when the dustproof filter requires cleaning



Refrigerant pressure gauge

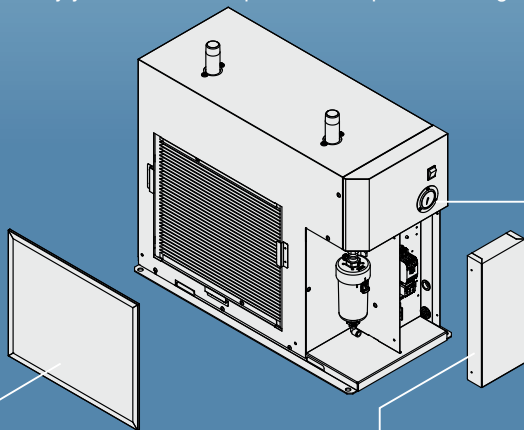

- Dustproof filter provided as a standard accessory





Prevents clogging of the condenser
 Can be installed without tools

- All electrical components are located in the front of the product.

The electrical components can be checked by removing the front panel.



Series Variations

Model	Rated inlet condition	Rated ambient temperature	Air flow capacity [m ³ /min]			Port size
			Dew point 3°C	Dew point 10°C	Dew point 20°C	
 IDFC60	50°C 0.7 MPa	35°C	0.9	2.8	4.7	R1
 IDFC70			1.6	4.7	7.8	R1 1/2
 New IDFC80			2.2	6.5	10.9	R2
 New IDFC90			3.1	9.2	15.4	

Options

p. 8

Optional accessories

p. 8



Auto Drain Valve Longer life, Higher resistance to foreign matter

Non-sliding part reduces the catching of foreign matter

Diaphragm type
Poppet type

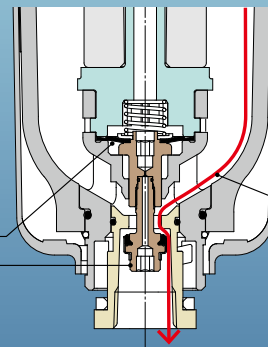

Shape prevents condensate accumulation

Condensate and foreign matter are discharged completely.



Easier maintenance

- One-touch mounting and removal of the bowl is possible without using any tools.

Release the lock by sliding the lock button down while holding the body. Then, rotate the bowl guard and pull down for removal.

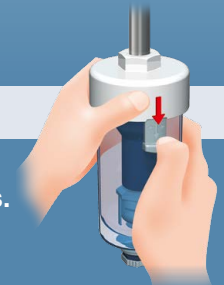

Transparent bowl guard

- Allows you to visually check the drainage condition in the bowl
- Improved environmental durability due to 2-layer construction



Selecting an ideal product for maximum energy savings

By choosing a dew point that is too low, you may have selected an air dryer with higher capabilities than necessary. Selecting a dryer with specifications appropriate for the operating environment can allow for savings in energy and space.

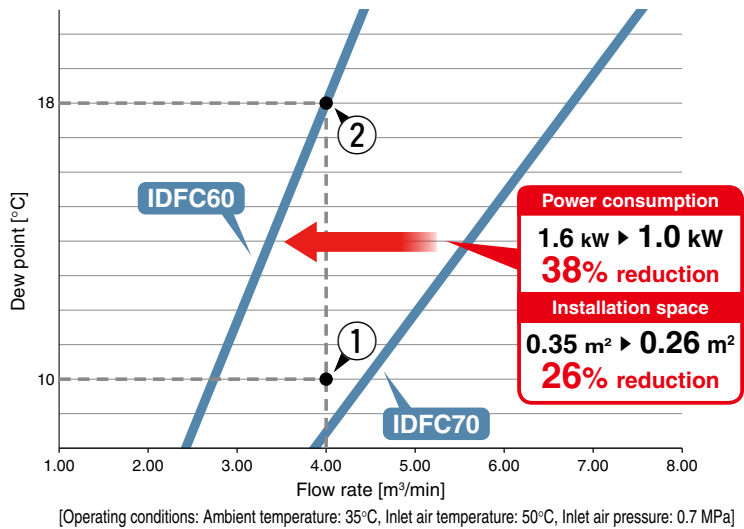
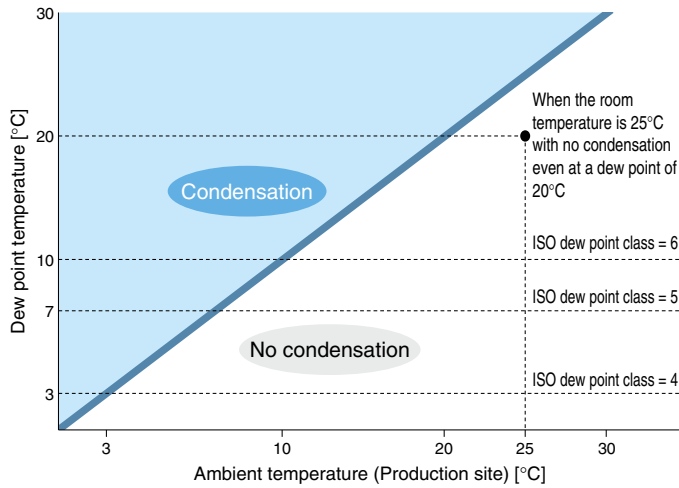

① When an air capacity of 4 m³/min is selected for a dew point of 10°C, the IDFC70 is required.

② If the production site temperature is above 20°C throughout the year, a dew point of 18°C can be selected.

**The IDFC60 can be selected.
Energy and space saving**

When air dryers are used for measurement instruments, a lower dew point might be required for the supply air. As shown in the diagram to the right, when a part of the production site requires a lower dew point, select air dryer ①, which does not require a lower dew point, for the main line, and select compact dryer ② (IDF or IDG series) separately for the end line to which the measurement instruments are mounted in order to save energy throughout the whole system.

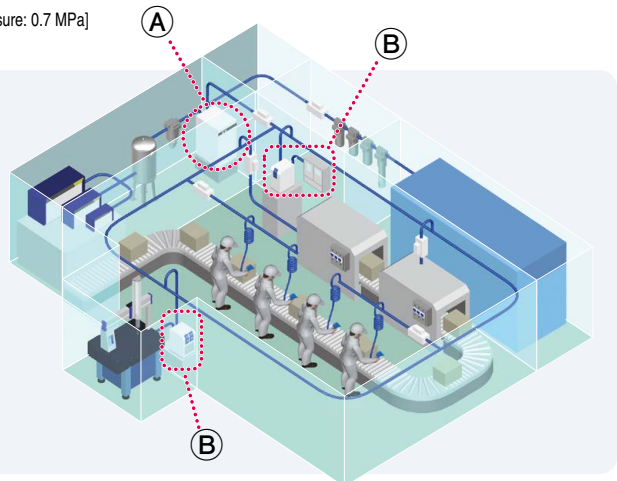

IDFC□ Series Model Selection

Air dryers should be selected based on the corrected air flow capacity while taking operating environment and facility into account. Select the air dryer model in accordance with the following procedure.

1 Read the correction factors.

Read the correction factors (A) to (D) suitable to the operating conditions.

2 Calculate the corrected air flow capacity.

Obtain the corrected air flow capacity from the following formula.

$$\text{Corrected air flow capacity} = \text{Air flow rate} \div (\text{Correction factor (A)} \times \text{Correction factor (B)} \times \text{Correction factor (C)} \times \text{Correction factor (D)})$$

3 Select the model.

Select the model with air flow capacity exceeding the calculated corrected air flow from data (E) of the table below.

IDFC Selection Example

Condition	Data symbol	Correction factor*1
Inlet air temperature	50°C	(A) 1
Ambient temperature	40°C	(B) 0.9
Inlet air pressure	0.6 MPa	(C) 0.91
Outlet air pressure dew point	10°C	(D) 0.6
Air flow rate	3.5 m³/min	—

*1 Values obtained from the table below

Corrected air flow capacity

$$= 3.5 \text{ m}^3/\text{min} \div (1 \times 0.9 \times 0.91 \times 0.6) = 7.12 \text{ m}^3/\text{min}$$

The model which exceeds the correct air flow capacity of 7.12 m³/min is IDFC70.

Data (A): Inlet Air Temperature

°C	35	40	45	50	55	60	65
Correction factor	1.58	1.46	1.09	1	0.79	0.64	0.51

Data (B): Ambient Temperature

°C	20	25	30	35	40	45
Correction factor	1.19	1.13	1.06	1	0.9	0.77

Data (C): Inlet Air Pressure

MPa	0.3	0.4	0.5	0.6	0.7	0.8	0.9	1.0
Correction factor	0.67	0.79	0.88	0.91	1	1.02	1.04	1.09

Data (D): Outlet Air Pressure Dew Point

°C	3	5	10	15	20
Correction factor	0.2	0.3	0.6	0.8	1

Data (E): Air Flow Capacity

Model	IDFC60	IDFC70	IDFC80	IDFC90
Compressor intake condition*1 [m³/min]	4.7	7.8	10.9	15.4
Standard condition (ANR)*2 [m³/min]	4.4	7.3	10.3	14.5

*1 Air flow capacity converted by the compressor intake condition [32°C, Atmospheric pressure, and 75% relative humidity]

*2 Air flow capacity under the standard condition (ANR) [20°C, Atmospheric pressure, and 65% relative humidity]

* Refer to page 8 for options.

* Refer to page 7 for optional accessories.

Refrigerated Air Dryer

IDFC60/70/80/90 Series

(Max. inlet air temperature: 65°C, Max. ambient temperature: 45°C)

How to Order

IDFC **60** - **23** -

Size

60
70
80
90

Voltage

Symbol	Voltage
23	Single-phase 230 VAC (50 Hz)

Options (Details ▶ See **p. 8**)

Symbol	Description
Nil	None
C	Anti-corrosive treatment for copper tube
L	With a heavy-duty auto drain (The maximum operating pressure is 1.6 MPa.)
R	With an earth leakage breaker
T	With a terminal block for operating, error and remote operation signals
V	With a timer controlled solenoid valve type auto drain (The maximum operating pressure is 1.6 MPa.)

* When multiple options are combined, indicate symbols in alphabetical order.

* The combination of L and V is not available.

Replacement Parts

Auto drain

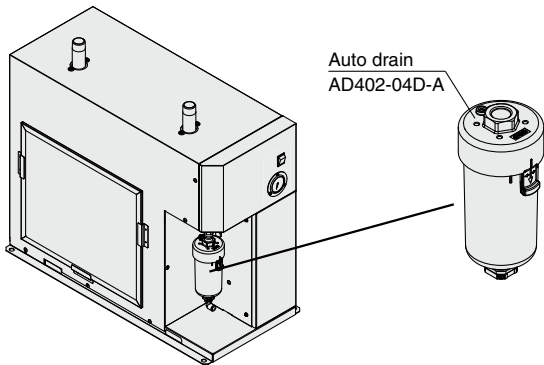

Auto Drain Replacement Parts Nos.

Description	Part no.	Qty.
Element	AD402P-040S	1
Bowl O-ring	KA00463	1
Bowl assembly*1	AD52-A	1

*1 Bowl O-ring is included.
One-touch fitting for connecting drain tube is not included.

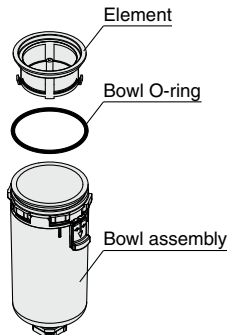

Dustproof filter

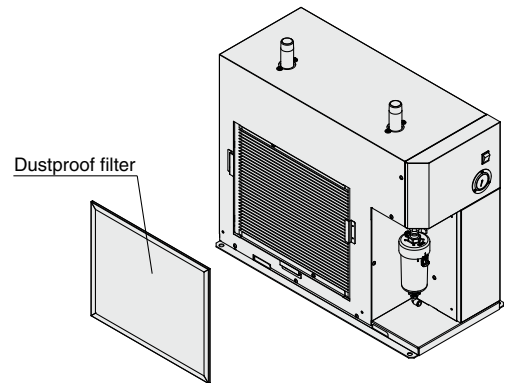

Dustproof Filter Replacement Parts Nos.

Part no.	Qty.	Dimension [mm]	Applicable model
IDF-S0530	1	H370 x W440	For IDFC60
IDF-S0531	1	H614 x W440	For IDFC70
IDF-S0535	1	H614 x W556	For IDFC80, IDFC90

Standard Specifications



Specifications		Model	IDFC60	IDFC70	IDFC80	IDFC90
Operating range ^{*1}	Fluid	Compressed air				
	Inlet air temperature [°C]	20 to 65				
	Inlet air pressure [MPa]	0.15 to 1.0 ^{*8}				
	Ambient temperature (Humidity) [°C]	20 to 45 (Relative humidity: 85% or less)				
Rated conditions ^{*3}	Air flow capacity ^{*2}	Outlet air pressure dew point: 20°C [m ³ /min]	4.7	7.8	10.9	15.4
		Outlet air pressure dew point: 10°C [m ³ /min]	2.8	4.7	6.5	9.2
		Outlet air pressure dew point: 3°C [m ³ /min]	0.9	1.6	2.2	3.1
	Inlet air pressure [MPa]	0.7				
	Inlet air temperature [°C]	50				
	Ambient temperature [°C]	35				
	Power supply voltage (Frequency)	Single-phase 230 VAC (50 Hz) Allowable voltage range ±10% ^{*4}				
Maximum air flow capacity		Air flow capacity calculated with the correction factors				
Electric spec.	Power consumption ^{*5} [kW]	1.0	1.6	2.4	2.8	
	Current consumption ^{*5} [A]	5.5	8.0	13.0	14.0	
	Applicable earth leakage breaker capacity ^{*6} [A]	10	15	20	30	
Cooling method		Air-cooled refrigeration				
Refrigerant		R410A (HFC) GWP: 2088 ^{*7}				
Refrigerant charge [g]		390	530	630	780	
Auto drain		Float type (Normally open, Min. operating pressure: 0.1 MPa)				
Port size		R1	R1 1/2	R2		
Weight [kg]		49	68	95	110	
Accessories		Drain tube (ø12: 3.5 m), Drain tube holder, Operation manual				

Symbol

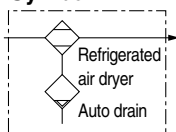

- *1 The operating range does not guarantee use with normal air flow capacity.
- *2 Air flow capacity converted by the compressor intake condition [32°C, Atmospheric pressure, and 75% relative humidity]
- *3 When the operating conditions are different from the rated values, select a model in accordance with Model Selection (page 4) or calculate the air flow capacity suitable to the operating conditions based on the Correction of Air Flow Capacity.
- *4 Do not use this product with continuous voltage fluctuations.
- *5 These values are reference values under rated conditions (Outlet air pressure dew point: 20°C) and are not guaranteed. Do not use these values for the thermal relay set values, etc.
- *6 Products other than Option R are not equipped with an earth leakage breaker. Purchase an appropriate earth leakage breaker separately. Use an earth leakage breaker with a leak current sensitivity of 30 mA.
- *7 This is the value specified by IPCC4 AR4. The value specified by the Revised Fluorocarbons Recovery and Destruction Law (Japanese law) is R410A GWP: 2090.
- *8 The maximum operating pressure is 1.0 MPa as standard, but it is possible to achieve 1.6 MPa when selecting Option L.

Correction of Air Flow Capacity

Correction Factors

Inlet air temperature [°C]						
35	40	45	50	55	60	65
1.58	1.46	1.09	1.0	0.79	0.64	0.51

Ambient temperature [°C]					
20	25	30	35	40	45
1.19	1.13	1.06	1.0	0.9	0.77

Inlet air pressure [MPa]							
0.3	0.4	0.5	0.6	0.7	0.8	0.9	1.0
0.67	0.79	0.88	0.91	1.0	1.02	1.04	1.09

(Calculation example: The air flow capacity when the dew point of the IDFC60 is set to 10°C under the following conditions is calculated. [Operating conditions: Inlet air temperature: 45°C, Ambient temperature: 30°C, Inlet air pressure: 0.8 MPa]
2.8 m³/min x 1.09 x 1.06 x 1.02 = 3.3 m³/min)

Construction (Air/Refrigerant Circuit)

Humid, hot air coming into the air dryer will be cooled down by a cooler re-heater (heat exchanger). Water condensed at this time will be removed from the air by an auto drain and drained out automatically. Air separated from the water will be heated by a cooler re-heater (heat exchanger) to obtain the dried air, which goes through to the outlet side.

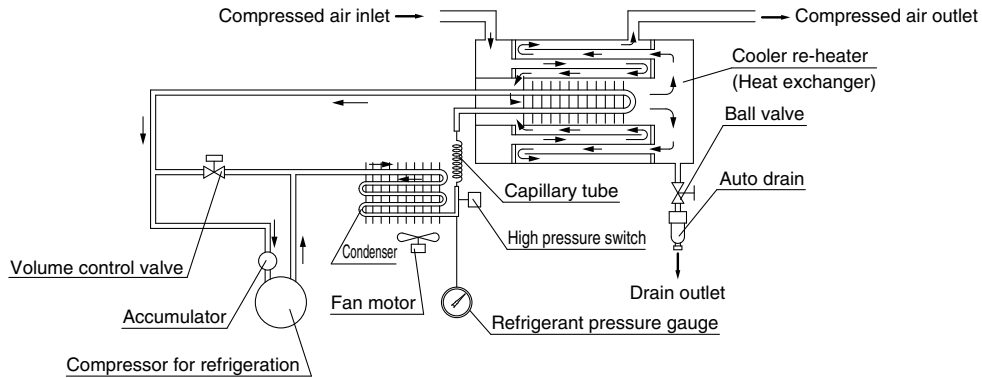

Dimensions

IDFC60, 70, 80, 90

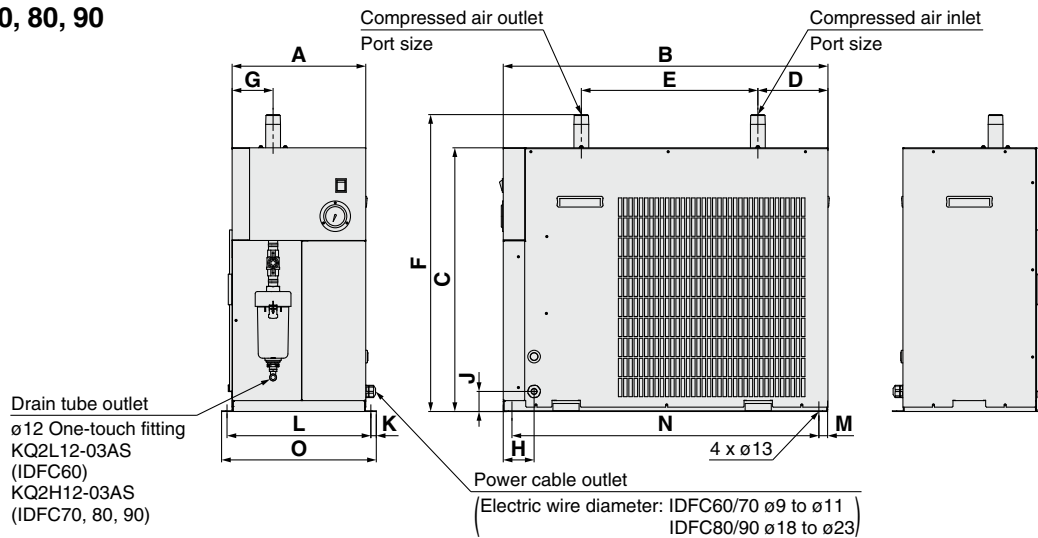

Model	Port size	A	B	C	D	E	F	G	H	J	K	L	M	N	O
IDFC60	R1	307	745	605	161	405	681	94	71	46	12.5	330	20	704	355
IDFC70	R1 1/2	342	890	825	176	905	905		68			365		849	390
IDFC80	R2	438	957	863	169	480	958	219	78	100	11.0	463		916	485
IDFC90															

Optional Accessories

[Foundation bolt set]

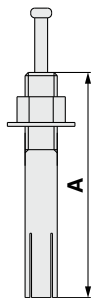

For fixing the air dryer to the foundations.
Easy to secure by striking the axle.

Mounting hole dia.: ø10.5

Dimensions [mm]				
Part no.	Nominal thread size	Material	Number of 1 set	A
IDF-AB500	M10	Stainless steel	4	50

[Piping adapter]

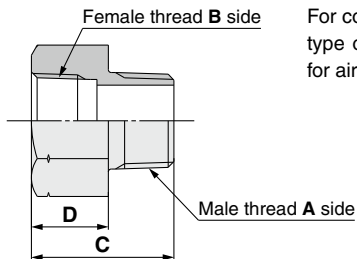
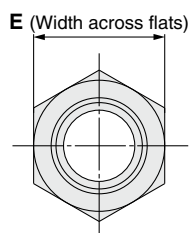

For converting the thread type of an IN/OUT fitting for air dryers.

Part no.	Thread type and port size		C	D	E	Material	Number of 1 set
	Male thread A side	Female thread B side					
IDF-AP604	NPT1	Rc1	50	27	46	Brass	2
IDF-AP606	NPT1 1/2	Rc1 1/2	55	31	54		
IDF-AP607	NPT2	Rc2	65	30	70		

IDFC Series Options

C Option symbol Anti-corrosive treatment for copper tube

This minimizes the corrosion of the copper and copper alloy parts when the air dryer is used in an atmosphere containing hydrogen sulfide or sulfurous acid gas. (Corrosion cannot be completely prevented.)
Special epoxy coating: Copper tube and copper alloy parts. The coating is not applied on the heat exchanger or around electrical parts, where operation may be affected by the coating.

* Failure due to corrosion is not covered under warranty.

L Option symbol With a heavy-duty auto drain (applicable to moderate pressure)

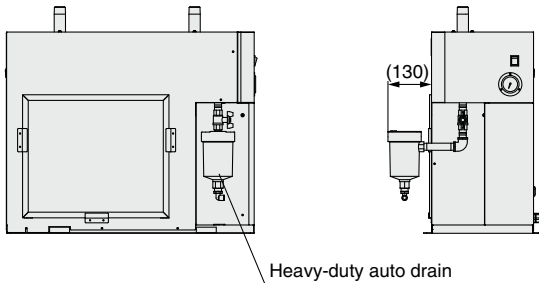

The float type auto drain used in the standard air dryer is replaced with a heavy-duty auto drain (ADH4000-04) which enables the drainage to discharge more efficiently. The product can be used for middle pressure with this option.

Max. operating pressure: 1.6 MPa



* The heavy-duty auto drain and piping materials (nipple, elbow) are shipped together with the main body of the air dryer. Customers are required to mount the parts to the air dryer.

Replacement Parts: Heavy-Duty Auto Drain

Replacement part no. (Description)	Configuration
ADH4000-04 (Heavy-duty auto drain)	 Heavy-duty auto drain
ADH-E400 (Replacement kit for exhaust mechanism)	 Replacement kit for exhaust mechanism
	 Housing (Use existing equipment.)

R Option symbol With an earth leakage breaker

The air dryer is equipped with an earth leakage breaker, reducing the electrical wiring required during installation.

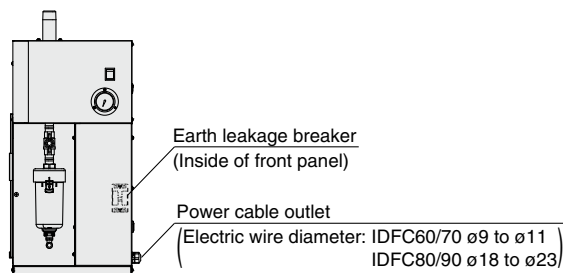

T Option symbol With a terminal block for operating, error and remote operation signals

In addition to power supply connection, terminal blocks for operating, error and remote operation signals are available.

- The operating and error signals are no-voltage contact style.
Operating signal...During operation: contact "close", During stop: contact "open"
Error signal...During error: contact "close", During stop: contact "open"
Contact capacity...Rated load voltage: 240 VAC or less/24 VDC or less
Max. load current: 5 A (Resistance load)/2 A (Induction load)
Min. applicable load: 20 VDC, 3 mA
- Power supply voltage is applied to the remote operation contact. The external switch is to be prepared by customers. Position holding switch (alternate type switch) or automatic return switch (momentary switch) can be used.

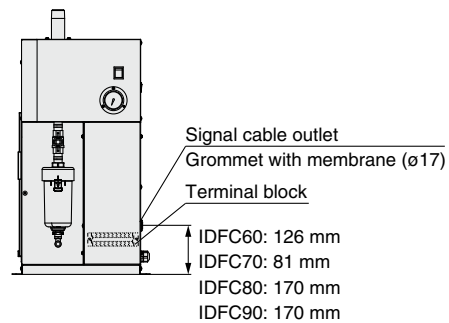

V Option symbol With a timer controlled solenoid valve type auto drain (applicable to moderate pressure)

Drainage is discharged by controlling a solenoid valve with a timer. A strainer for solenoid valve protection and a stop valve are also included.

Maximum operating pressure: 1.6 MPa

Replacement Parts

Part no.	Note
IDF-S0534	200 VAC to 230 VAC

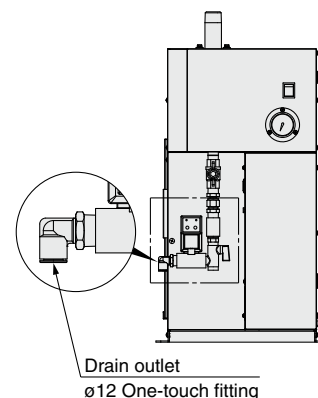



IDFC Series

Specific Product Precautions 1

Be sure to read this before handling the products. Refer to the back cover for Safety Instructions. For air preparation equipment precautions, refer to the Handling Precautions for SMC Products and the Operation Manual on the SMC website: <https://www.smcworld.com>

Installation

⚠ Caution

- Avoid locations where the air dryer will be in direct contact with wind or rain. (Avoid locations where relative humidity is 85% or more.)
- Avoid locations where water, water vapor, salt water, or oil may splash on the product.
- Avoid locations where dust or other particles are present.
- Avoid locations where flammable or explosive gases are present.
- Avoid locations where corrosive gases, solvents, or combustible gases are present.
- Avoid locations which receive direct sunlight or radiated heat.
- Avoid locations where the ambient temperature exceeds the limits as mentioned below.
During operation: 20 to 45°C
During storage: 0 to 50°C (when there is no drain water inside of the piping)
- Avoid locations where temperature substantially changes.
- Avoid locations where strong magnetic noise occurs. (Avoid locations where strong electric fields, strong magnetic fields, or surge voltages occur.)
- Avoid locations where static electricity occurs or conditions which make the product discharge static electricity.
- Avoid locations where high frequencies occur.
- Avoid locations where damage is likely to occur due to lightning.
- Avoid installation on machines used for transporting, such as vehicles, ships, etc.
- Avoid locations at altitudes of 2000 meters or higher.
- Avoid locations where strong impacts or vibrations occur.
- Avoid conditions where a massive force strong enough to deform the product is applied or the weight from a heavy object is applied.
- Avoid locations with insufficient space for maintenance.
- Avoid locations where the ventilation grille is obstructed.
- Avoid locations where the air dryer will draw in high-temperature air discharged from an air compressor or other dryer.

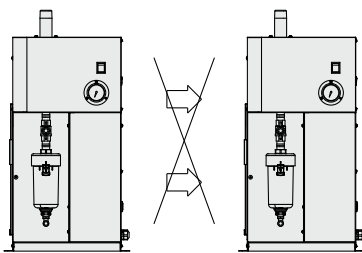

Confirm that the exhaust air does not flow into the neighboring equipment.

- Avoid pneumatic circuits where rapid pressure fluctuations or flow speed changes are generated.

Drain Tube

⚠ Caution

- A tube with an outside diameter of 12 mm is attached as a drain tube. Use this tube to discharge drainage to a drain tank, etc.
- Do not use the drain tube in an upward direction. Do not bend or crush the drain tube. If it is unavoidable that the tube goes upward, make sure it only goes as far as the position of the auto drain outlet. The drain tube to be prepared should have an O.D. of 12 mm, an I.D. of 8 mm or more, and be 5 m or less in length. Otherwise, the auto drain will not operate correctly, which may cause air to be blown constantly or moisture not to be exhausted.

Power Supply

⚠ Caution

- Connect the power supply to the terminal block.
 - Install an earth leakage breaker*1 suitable to each model for the power supply.
 - Maintain a voltage range within $\pm 10\%$ of the rated voltage. (Do not use this product with continuous voltage fluctuations.)
- *1 Select an earth leakage breaker with a leak current sensitivity of 30 mA.
Regarding the rated current, refer to the Applicable Earth Leakage Breaker Capacity.
- When a short-term interruption of the power supply (including momentary interruptions) occurs in this equipment, the restarting of normal operations may require some time or may be impossible due to the operation of protective devices even after the supply of power returns.

Air Piping

⚠ Caution

- Be careful to avoid any errors in connecting the air piping at the compressed air inlet (IN) and outlet (OUT).
- Flush the piping sufficiently in order to avoid any foreign matter such as dust, sealant tape, liquid gasket, etc., before connecting piping. Foreign matter in the piping can cause cooling failure or drainage failure.
- Inlet and outlet compressed air connections should be made removable by using a union, etc.
- Provide bypass piping to make it possible to do maintenance without stopping the air compressor.
- When tightening the inlet/outlet air piping, firmly hold the port on the air dryer with a pipe wrench, etc.
- Use pipes and fittings that can endure the operating pressure and temperature. Connect them firmly to prevent air leakage.
- Do not allow the load of the piping to lie directly on the air dryer. When mounting any part, such as an air filter, on the fitting at the compressed air inlet or outlet port, support the part to prevent excessive force from being applied to the product.
- Be careful not to let the vibrations of the air compressor transmit.
- If a metallic flexible tubing is used for the inlet/outlet air piping, abnormal noise might be generated in the piping. In such cases, please use steel tubing instead.
- If the temperature of the compressed air on the inlet side is over 65°C, place an aftercooler after the air compressor. Or, lower the temperature of the place where the air compressor is installed to below 65°C.
- If the air supply generates high pressure fluctuations (pulsations), take appropriate countermeasures, such as installing an air tank.
- If rapid pressure fluctuations or flow changes occur, install a filter on the dryer outlet to prevent drain from splashing.
- Variations in operating conditions may cause condensation to form on the surface of the outlet piping. Apply thermal insulation around the piping to prevent condensation from forming.

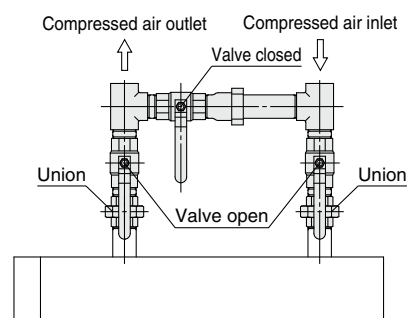



IDFC□ Series

Specific Product Precautions 2

Be sure to read this before handling the products. Refer to the back cover for Safety Instructions. For air preparation equipment precautions, refer to the Handling Precautions for SMC Products and the Operation Manual on the SMC website: <https://www.smcworld.com>

Protection Circuit

⚠ Caution

When the air dryer is operated in the following cases, the protection circuit will activate, the light will turn off and the air dryer will come to stop.

- The compressed air temperature is too high.
- The compressed air flow rate is too high.
- The ambient temperature is too high. (45°C or higher)
- The fluctuation of the power supply voltage is beyond ±10% of the rated voltage.
- The air dryer is drawing in high temperature air exhausted from an air compressor or other dryer.
- The ventilation grille is obstructed by a wall or clogged with dust.

Transportation and Installation

⚠ Warning

Be sure to follow the instructions below for transporting the product.

- The product is filled with refrigerant. Transport it (by land, sea or air) in accordance with laws and regulations specified.
- When carrying the product, be careful not to let it drop or fall over, and use a forklift.
- Do not lift the product by holding the panel, fittings or piping.
- Never lay the product down for transportation. This may lead to damage to the product.

- The product is heavy and has potential dangers in transportation. Be sure to follow the instructions above.
- Be sure to use a forklift for transporting the product. Weight of each model with packaging: IDFC60: 57 kg, IDFC70: 78 kg, IDFC80: 106 kg, IDFC90: 122 kg

Compressor Air Delivery

⚠ Caution

Since the auto drain is designed in such a way that the valve remains open unless the air pressure rises to 0.1 MPa or higher, air will blow out from the drain outlet at the time of air compressor start up until the pressure increases. Therefore, if an air compressor has a small air delivery, the pressure may not be sufficient.

Auto Drain

⚠ Caution

The auto drain may not function properly, depending on the quality of the compressed air. Check the operation once a day.

Cleaning of Ventilation Area

⚠ Caution

If the dustproof filter becomes clogged with dust or debris, a decline in cooling performance can result.

In order to avoid deforming or damaging the dustproof filter, clean it with a long-haired brush or air gun once a month.

Time Delay for Restarting

⚠ Caution

Allow at least three minutes before restarting the air dryer. Otherwise, the protection circuit will activate, the light will turn off and the air dryer will not start up.

Modifying the Standard Specifications

⚠ Caution

Do not modify the standard product using any of the optional specifications once the product has been supplied to a customer. Check the specifications carefully before selecting an air dryer.

■ Refrigerant with GWP Reference

Refrigerant	Global Warming Potential (GWP)	
	Regulation (EU) No 517/2014 (Based on the IPCC AR4)	Revised Fluorocarbons Recovery and Destruction Law (Japanese law)
R134a	1430	1430
R404A	3922	3920
R407C	1774	1770
R410A	2088	2090

* This product is hermetically sealed and contains fluorinated greenhouse gases (HFC). When this product is sold on the market in the EU after January 1, 2017, it needs to be compliant with the quota system of the F-Gas Regulation in the EU.

* See specification table for refrigerant used in the product.

Safety Instructions

These safety instructions are intended to prevent hazardous situations and/or equipment damage. These instructions indicate the level of potential hazard with the labels of “**Caution**,” “**Warning**” or “**Danger**.” They are all important notes for safety and must be followed in addition to International Standards (ISO/IEC)*1), and other safety regulations.

 **Caution:** **Caution** indicates a hazard with a low level of risk which, if not avoided, could result in minor or moderate injury.

 **Warning:** **Warning** indicates a hazard with a medium level of risk which, if not avoided, could result in death or serious injury.

 **Danger :** **Danger** indicates a hazard with a high level of risk which, if not avoided, will result in death or serious injury.

*1) ISO 4414: Pneumatic fluid power – General rules relating to systems.
ISO 4413: Hydraulic fluid power – General rules relating to systems.
IEC 60204-1: Safety of machinery – Electrical equipment of machines.
(Part 1: General requirements)
ISO 10218-1: Manipulating industrial robots – Safety.
etc.

Warning

1. The compatibility of the product is the responsibility of the person who designs the equipment or decides its specifications.

Since the product specified here is used under various operating conditions, its compatibility with specific equipment must be decided by the person who designs the equipment or decides its specifications based on necessary analysis and test results. The expected performance and safety assurance of the equipment will be the responsibility of the person who has determined its compatibility with the product. This person should also continuously review all specifications of the product referring to its latest catalog information, with a view to giving due consideration to any possibility of equipment failure when configuring the equipment.

2. Only personnel with appropriate training should operate machinery and equipment.

The product specified here may become unsafe if handled incorrectly. The assembly, operation and maintenance of machines or equipment including our products must be performed by an operator who is appropriately trained and experienced.

3. Do not service or attempt to remove product and machinery/equipment until safety is confirmed.

1. The inspection and maintenance of machinery/equipment should only be performed after measures to prevent falling or runaway of the driven objects have been confirmed.
2. When the product is to be removed, confirm that the safety measures as mentioned above are implemented and the power from any appropriate source is cut, and read and understand the specific product precautions of all relevant products carefully.
3. Before machinery/equipment is restarted, take measures to prevent unexpected operation and malfunction.

4. Contact SMC beforehand and take special consideration of safety measures if the product is to be used in any of the following conditions.

1. Conditions and environments outside of the given specifications, or use outdoors or in a place exposed to direct sunlight.
2. Installation on equipment in conjunction with atomic energy, railways, air navigation, space, shipping, vehicles, military, medical treatment, combustion and recreation, or equipment in contact with food and beverages, emergency stop circuits, clutch and brake circuits in press applications, safety equipment or other applications unsuitable for the standard specifications described in the product catalog.
3. An application which could have negative effects on people, property, or animals requiring special safety analysis.
4. Use in an interlock circuit, which requires the provision of double interlock for possible failure by using a mechanical protective function, and periodical checks to confirm proper operation.

Caution

1. The product is provided for use in manufacturing industries.

The product herein described is basically provided for peaceful use in manufacturing industries.
If considering using the product in other industries, consult SMC beforehand and exchange specifications or a contract if necessary.
If anything is unclear, contact your nearest sales branch.

Limited warranty and Disclaimer/ Compliance Requirements

The product used is subject to the following “Limited warranty and Disclaimer” and “Compliance Requirements”.

Read and accept them before using the product.

Limited warranty and Disclaimer

1. The warranty period of the product is 1 year in service or 1.5 years after the product is delivered, whichever is first.*2)
Also, the product may have specified durability, running distance or replacement parts. Please consult your nearest sales branch.
2. For any failure or damage reported within the warranty period which is clearly our responsibility, a replacement product or necessary parts will be provided.
This limited warranty applies only to our product independently, and not to any other damage incurred due to the failure of the product.
3. Prior to using SMC products, please read and understand the warranty terms and disclaimers noted in the specified catalog for the particular products.

*2) Vacuum pads are excluded from this 1 year warranty.

A vacuum pad is a consumable part, so it is warranted for a year after it is delivered.
Also, even within the warranty period, the wear of a product due to the use of the vacuum pad or failure due to the deterioration of rubber material are not covered by the limited warranty.

Compliance Requirements

1. The use of SMC products with production equipment for the manufacture of weapons of mass destruction (WMD) or any other weapon is strictly prohibited.
2. The exports of SMC products or technology from one country to another are governed by the relevant security laws and regulations of the countries involved in the transaction. Prior to the shipment of a SMC product to another country, assure that all local rules governing that export are known and followed.

Caution

SMC products are not intended for use as instruments for legal metrology.

Measurement instruments that SMC manufactures or sells have not been qualified by type approval tests relevant to the metrology (measurement) laws of each country. Therefore, SMC products cannot be used for business or certification ordained by the metrology (measurement) laws of each country.

Revision History

Edition B	* The IDFC80 and IDFC90 series have been added.	WO
Edition C	* The option (with a timer controlled solenoid valve type auto drain) has been added.	XO

Safety Instructions

Be sure to read the “Handling Precautions for SMC Products” (M-E03-3) and “Operation Manual” before use.