

Operating manual  
Handheld Pressure-Meter  
for GMSD, GMXD, MSD und MXD - Pressure Sensors

As of Version 7.4

## GMH 3111



**GMH 31 Series**  
Druck / Pressure



WEEE-Reg.-Nr. DE 93889386

# CONTENTS

<b>1</b>	<b>GENERAL NOTE .....</b>	<b>3</b>
<b>2</b>	<b>SAFETY .....</b>	<b>3</b>
2.1	INTENDED USE.....	3
2.2	SAFETY SIGNS AND SYMBOLS.....	3
2.3	SAFETY GUIDELINES.....	3
<b>3</b>	<b>PRODUCT SPECIFICATION .....</b>	<b>4</b>
3.1	SCOPE OF SUPPLY .....	4
3.2	OPERATION AND MAINTENANCE ADVICE .....	4
<b>4</b>	<b>HANDLING .....</b>	<b>5</b>
4.1	DISPLAY .....	5
4.2	BASIC OPERATION .....	5
4.3	CONNECTIONS .....	6
4.4	POP-UP CLIP.....	6
<b>5</b>	<b>START OPERATION .....</b>	<b>7</b>
<b>6</b>	<b>CONFIGURATION .....</b>	<b>7</b>
<b>7</b>	<b>REMARKS TO SPECIAL FEATURES .....</b>	<b>7</b>
7.1	MEASURING OF WATER LEVEL – DISPLAY UNIT [M] .....	7
7.2	SEA LEVEL CORRECTION FOR ABSOLUTE PRESSURE SENSORS.....	8
7.3	POWER OFF TIME.....	8
<b>8</b>	<b>OUTPUT.....</b>	<b>8</b>
8.1	SERIAL INTERFACE.....	8
<b>9</b>	<b>INPUT ADJUSTMENT .....</b>	<b>9</b>
9.2	ZERO DISPLACEMENT SENSOR ('OFFS') .....	9
9.3	SCALE CORRECTION SENSOR ('SCAL') .....	9
9.4	CALIBRATION SERVICES .....	9
<b>10</b>	<b>PRESSURE CONNECTION.....</b>	<b>9</b>
10.1	ABSOLUTE PRESSURE SENSORS (TYPES: GMSD/GMXD...BA) .....	9
10.2	RELATIVE PRESSURE SENSORS (TYPES: GMSD/GMXD...MR, GSMD/GMXD...BR).....	9
10.3	STAINLESS STEEL PRESSURE SENSORS (TYPES: GMSD/GMXD...MRE, GMSD/GMXD...BRE, GMSD/GMXD...BAE AND MSD/MXD...MRE, MSD/MXD...BRE, MSD/MXD...BAE WITH MSD-K31).....	10
<b>11</b>	<b>ERROR AND SYSTEM MESSAGES .....</b>	<b>10</b>
<b>12</b>	<b>SPECIFICATION.....</b>	<b>11</b>
<b>13</b>	<b>RESHIPMENT, DISPOSAL AND DECOMMISSIONING .....</b>	<b>12</b>
13.1	RESHIPMENT .....	12
13.2	DISPOSAL INSTRUCTIONS .....	12
13.3	DECOMMISSIONING .....	12

# 1 General Note

Read this document carefully and get used to the operation of the device before you use it. Keep this document within easy reach near the device for consulting in case of doubt.

## 2 Safety

### 2.1 Intended Use

This device is designed for the mobile use or the stationary operation in a controlled electromagnetic environment (lab).

This device must only be used with "GMSD... - K31" or "MSD ... ..E" pressure sensors. Other usages are not intended. Make sure that the measured pressure fits to the measuring range of the connected sensor.

Personnel which starts up, operates and maintains the device has to have sufficient knowledge of the measuring procedure and the meaning of the resulting measured values, this manual delivers a valuable help for this. The instructions of the manual have to be understood, regarded and followed.

To be sure that there's no risk arising due to misinterpretation of measured values, the operator must have further knowledge in case of doubt - the user is liable for any harm/damage resulting from misinterpretation due to insufficient knowledge.

The manufacturer will assume no liability or warranty in case of usage for other purpose than the intended one, ignoring this manual, operating by unqualified staff as well as unauthorized modifications to the device.

The safety requirements (see below) have to be observed.

The device must be used only according to its intended purpose and under suitable conditions.

Use the device carefully and according to its technical data (do not throw it, strike it, ...)

Protect the device from dirt.

### 2.2 Safety signs and symbols

Warnings are labeled in this document with the followings signs:



**Caution!** This symbol warns of imminent danger, death, serious injuries and significant damage to property at non-observance.



**Attention!** This symbol warns of possible dangers or dangerous situations which can provoke damage to the device or environment at non-observance.







**Note!** This symbol point out processes which can indirectly influence operation or provoke unforeseen reactions at non-observance.

### 2.3 Safety guidelines

This device has been designed and tested in accordance with the safety regulations for electronic devices. However, its trouble-free operation and reliability cannot be guaranteed unless the standard safety measures and special safety advises given in this manual will be adhered to when using the device.

1. Trouble-free operation and reliability of the device can only be guaranteed if the device is not subjected to any other climatic conditions than those stated under "Specification".

If the device is transported from a cold to a warm environment condensation may cause in a failure of the function. In such a case make sure the device temperature has adjusted to the ambient temperature before trying a new start-up.

2.  **DANGER** If there is a risk whatsoever involved in running it, the device has to be switched off immediately and to be marked accordingly to avoid re-starting.  
Operator safety may be a risk if:
- there is visible damage to the device
  - the device is not working as specified
  - the device has been stored under unsuitable conditions for a longer time.
- In case of doubt, please return device to manufacturer for repair or maintenance.
3. When connecting the device to other devices the connection has to be designed most thoroughly as internal connections in third-party devices (e.g. connection GND with protective earth) may lead to undesired voltage potentials that can lead to malfunctions or destroying of the device and the connected devices.
-  **DANGER** This device must not be run with a defective or damaged power supply unit.  
Danger to life due to electrical shock!
4.  **DANGER** Do not use these products as safety or emergency stop devices or in any other application where failure of the product could result in personal injury or material damage.  
Failure to comply with these instructions could result in death or serious injury and material damage.
5.  **DANGER** Only devices with are specially mark for Ex-protection can be used at potentially explosive areas. Devices that are **not** marked for Ex-protection **must not** be used at potentially explosive areas! The usage of this device at potentially explosive areas increases danger of deflagration, explosion or fire due to sparking.

## 3 Product Specification

### 3.1 Scope of supply

The scope of supply includes:

- Measuring device with 9V battery
- Operation manual

### 3.2 Operation and maintenance advice

#### • Battery operation:

If 'bAt' is shown in the lower display the battery has been used up and needs to be replaced. However, the device will operate correctly for a certain time. If 'bAt' is shown in the upper display the voltage is too low to operate the device; the battery has been completely used up.



***The battery has to be taken out, when storing device above 50 °C.***

***We recommend taking out battery if device is not used for a longer period of time.***

***After recommissioning the real-time clock has to be set again.***

#### • Mains operation with power supply



When using a power supply please note that operating voltage has to be 10.5 to 12 V DC.

Do not apply overvoltage!! Cheap 12V-power supplies often have excessive no-load voltage.

We, therefore, recommend using regulated voltage power supplies.

Trouble-free operation is guaranteed by our power supply GNG10/3000.

Prior to connecting the power supply to the mains, make sure that the operating voltage stated at the power supply is identical to the mains voltage.

- Treat device and sensor carefully. Use only in accordance with above specification. (do not throw, hit against etc.). Protect plug and socket from soiling.

#### • Connecting/changing sensors



Use only sensors of GMSD ... - K31 or MSD - series!

Other sensors may lead to damage to the device and the sensor.

Switch off device before changing the sensor.

# 4 Handling

## 4.1 Display

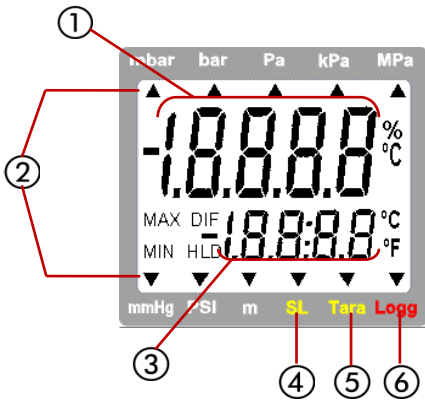

- 1 **Main display:** shows actual value

---

- 2 Arrow points to the chosen measuring **unit**

---

- 3 **Secondary display:** shows min./max. or hold value

---

- 4 **SL:** appears if sea-level-correction is activated

---

- 5 **Tara:** appears if tara-function is activated

---

- 6 **Logg:** *Not used*

## 4.2 Basic Operation

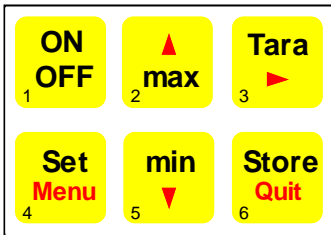

**On / Off**

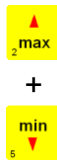

**min/max bei Messung:**

- press short: shows the min./max. value
- press again: hides min./max. value
- press 2 sec.: clears particular value



**Tara, zero-point adjustment:**

- press short: display will be set to 0  
The following measuring will be relatively displayed to the set tara value
- press 2 sec.: deactivates tara-function
- press 5 sec.: Zero-Point Adjustment<sup>1)</sup>



**Set/Menu:**

- press short: invokes configuration menu



**Store/Quit:**

- press short: hold-function, the last measuring value will be held in the secondary display.
- press again: hides the value

**Please Note: Activating/deactivating tara clears the max- & min-memories.**

<sup>1)</sup> **Zero-Point Adjustment:** If there is no pressure or zero-pressure (absolute) applied to the pressure ports the device will display 0. If there is a permanent deviation (and device is operated under steady conditions), a permanent zero point adjustment can be carried out. To carry out the adjustment press button 3 for approx. 5 seconds (Auto Null will be displayed shortly). The adjustment is done via the OFFSET-value of the sensor (referring configuration menu). To recall the manufacturer's calibration press button 3 for approx. 15 seconds.

*Please note: - A zero-point adjustment can only be carried out if the difference between the value on display is less than 500 digits!  
- If a zero point adjustment was carried out the display shows "Corr" after a restart .*

## 4.3 Connections

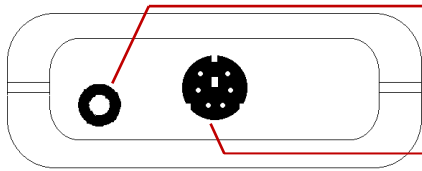

**Interface:** Connection for optically isolated interface adapter  
(accessory: USB 3100 or USB 3100 N,  
GRS 3100, GRS 3105,)

**Connections for pressure sensors:**  
of the GMSD, GMSD or MSD and MXD-family

**Power supply:** the mains adapter socket is located at the left side of the device.

## 4.4 Pop-up clip

### Handling:

- Pull at label "open" in order to swing open the pop-up clip.
- Pull at label "open" again to swing open the pop-up clip further.

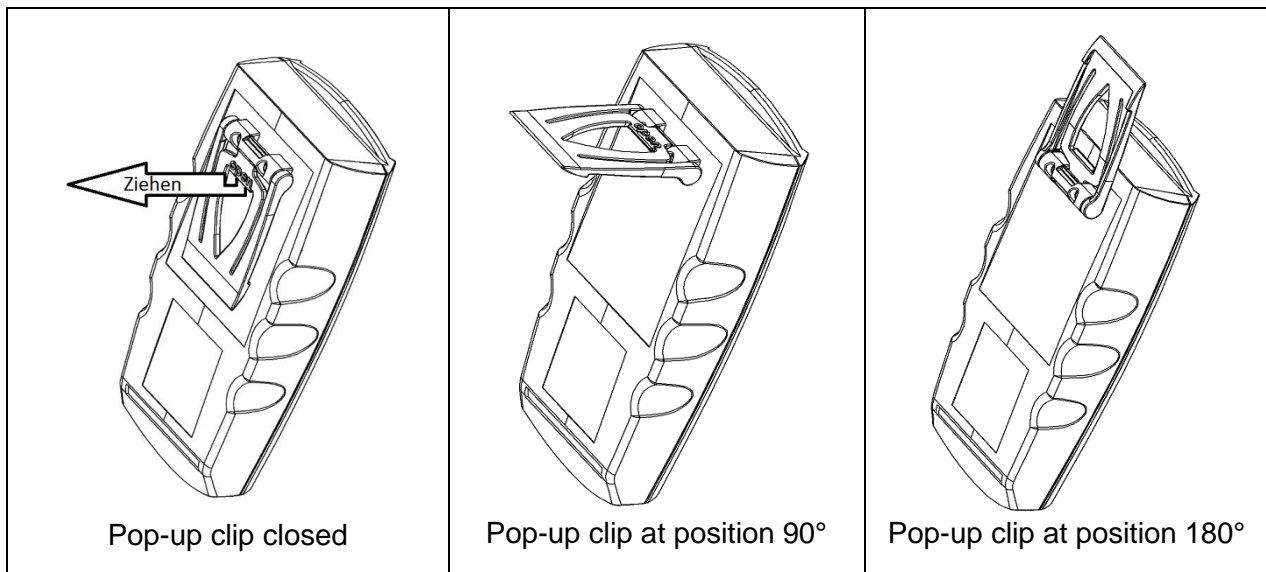

### Function:

- The device with a closed pop-up clip can be plainly laid onto a table or attached to a belt, etc.
- The device with pop-up clip at position 90° can be set up on a table, etc.
- The device with pop-up clip at position 180° can be suspended from a screw or the magnetic holder GMH 1300.

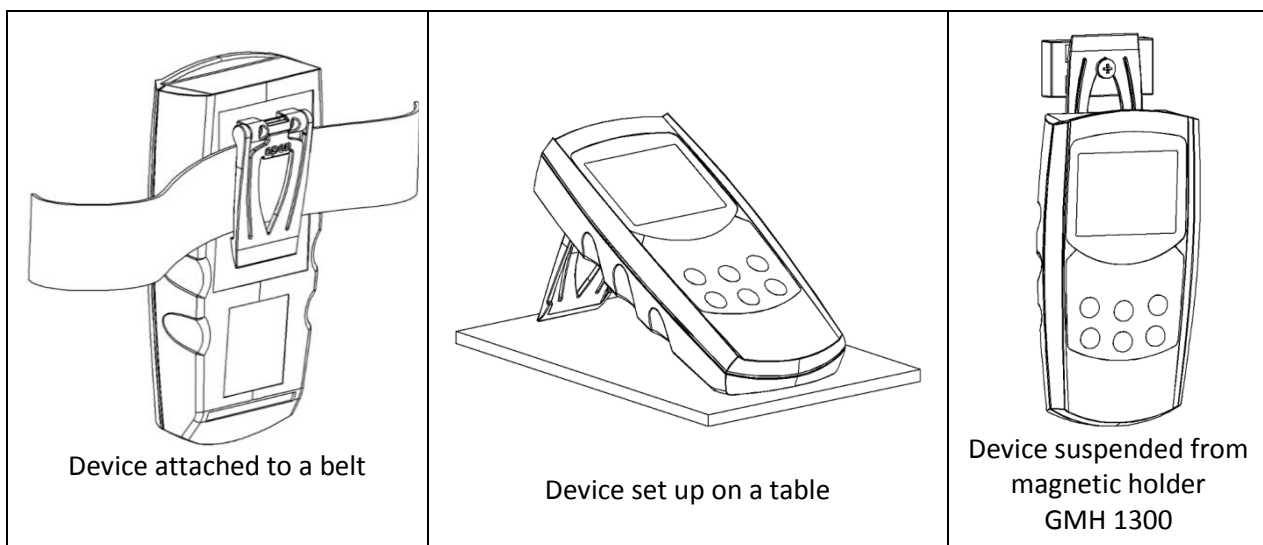

## 5 Start Operation

Connect sensor, turn on device via  key.



After segment test the device displays some configuration:

- If a **zero point adjustment** was carried out the display shows shortly „nuLL Corr“.

After that the device is ready for measuring.

## 6 Configuration

To change device settings, press **Menu** (key 4) for 2 seconds. This will call the configuration menu.

Pressing **Menu** jumps between the parameters.

The parameters can be changed with **▲** (key 2) or **▼** (key 5).

**Quit** (key 6) finishes the configuration and returns to standard measuring operation.

Parameter	Value	Description
„Menu“	▲ or ▼	
	mbar, bar, ...	<b>Unit:</b> Unit of display
	oFF/on	<b>Sea level correction:</b> on or off <i>(only available at GMH 3181-12)</i>
	-2000 ... 9999	<b>Altitude:</b> Input of altitude above sea level [m] (only if SL=on)
	1 ... 120	<b>Auto Power Off</b> time in minutes
	oFF	Auto Power Off deactivated
	01, 11 ... 91	Base <b>address</b> of interface
<b>OFFS</b>	Sensordep., e.g. -5.00...5.00 mbar	The <b>offset of sensor</b> will be displaced by this value to compensate for deviations in the probe or in the measuring device.
	oFF	Zero displacement inactive (=0.00)
<b>SCAL</b>	-2.000 ... 2.000	The measuring <b>scale of sensor</b> will be changed by this factor [%] to compensate deviations of temperature probe or measuring device
	oFF	Scale correction factor inactive (=0.000)

## 7 Remarks To Special Features

### 7.1 Measuring Of Water Level – Display Unit [m]

When using suitable waterproof pressure sensors, the unit [m] for meters of water can be set in the menu “Unit“. 10m of water are roughly 1 bar over pressure. Measurements can be made e.g. like described below:

- With one abs. pressure sensor (SL oFF!): Press ‚Tara‘ when sensor is at ambient air and then bring sensor to the depth to be measured. The display shows now the depth in [m].
- With one rel pressure sensor: bring tube connection for lower press. in contact to ambient air by means of a tube (no water contact!) and bring the sensor with its open press. connection for higher pressure to water depth to be measured (display and is compensated for pressure changes in ambient air).

## 7.2 Sea Level Correction for Absolute Pressure Sensors

The device displays the absolute pressure measured at the sensor. This is not necessarily the same like the values given by weather stations! The weather stations' values are giving the pressure at sea level. Usually the sensor is placed above sea level and therefore, if the value at sea level(zero) is to be measured, the pressure loss resulting from the actual level above sea level has to be considered! To correct the measuring display activate the „Sea-Level-Function“ (SL, p.r.t. chapter 6). Then enter the altitude above sea level of the sensor's location in meters (Alti, p.r.t. chapter 6). When activated, the display shows the SL-arrow and the device displays the pressure value at sea level.

## 7.3 Power off Time

If there won't be pressed any key and no interface communication takes place for the time of the power off time setting (P.Off), the device will be switched off automatically to save battery power.

If P.oFF = oFF then the automatic switch off is deactivated.

# 8 Output

## 8.1 Serial Interface

By means of the serial interface and a suitable electrically isolated interface adapter (USB 3100, USB 3100 N, GRS 3100 or GRS 3105) the device can be connected to a computer for data transfer.

With the GRS 3105 up to 5 devices of the GMH3xxx- series can be connected to one interface (see also manual of GRS 3105). As a precondition the base addresses of all devices must not be identical, make sure to configure the base addresses accordingly (refer menu point "Adr." in chapter 6).

To avoid transmission errors, there are several security checks implemented e.g. CRC.

The following standard software packages are available:

- **GMHKonfig:** Software for a comfortable editing of the device (e.g. Material selection...)
- **EBS 20M / 60M:** 20-/60-channel software to display the measuring values

In case you want to develop your own software we offer a **GMH3000-development package** including:

- A universally applicable Windows functions library ('GMH3000.DLL') with documentation that can be used by the most programming languages. Suitable for Windows XP™, Windows Vista™, Windows 7™, Windows 8 / 8.1™, Windows 10™
- Programming examples Visual Studio 2010 (C#, C++ and VB), Testpoint™, LabView™ etc.

**Note: The measuring and display range values read back from the interface are always in the selected measurement unit (mbar, bar...)!**

Supported functions:

Code	Name/Function	Code	Name/Function
0	Read measurement value	200	Read min display range
3	Read system state	201	Read max display range
6	Read min value	202	Read display range - unit
7	Read max value	204	Read display range - decimal point
12	Read ID number	208	Read # of channels
176	Read min measuring range	214	Read Scale adjustment[%]
177	Read max measuring range	216	Read Offset adjustment
178	Read measuring range unit	222	Read power off time (Conf-P.oFF)
179	Read measuring range decimal point	223	Set power off time (Conf-P.oFF)
180	Read kind of measuring of sensor	240	Reset
199	Read kind of measuring of display	254	Program version



## 9 Input Adjustment

### 9.1 Drift of Measurements

The GMH 31 with its according sensors is a highly stable measuring system with extreme low drift. Although especially in harsh environments the displayed value of the measuring chain „instrument + sensor“ may drift over time. Depending on the application and need of precision we recommend a regular check.

Deviations can be compensated with zero displacement and scale correction (see below).

At normal use a checking each year is recommended. A system check at the manufacturer is recommended in case of doubt: see chapter Calibration Services Calibration Services.

### 9.2 Zero Displacement Sensor ('OFFS')

A zero displacement can be carried out for the measured value:

$$\text{value displayed} = \text{value measured} - \text{offset}$$

Standard setting: 'off' = 0.0°, i.e. no zero displacement will be carried out. Together with the scale correction (see below) this factor is mainly used to compensate for sensor deviations. Input is in the display unit.

### 9.3 Scale Correction Sensor ('SCAL')

The scale of the measuring can be influenced by this setting (factor is in %):

$$\text{displayed value} = \text{measured value} * (1 + \text{Scal}/100)$$

Standard setting: 'off' = 0.000, i.e. value is not corrected. Together with the zero displacement (see above) this factor is mainly used to compensate for sensor deviations.

### 9.4 Calibration Services

Calibration certificates – DKD-certificates – other certificates:

If device should be certificated for its accuracy, it is the best solution to return it to the manufacturer.

Only the manufacturer is capable to do efficient recalibration if necessary to get results of highest accuracy!

## 10 Pressure Connection

The device is designed to be connected to the sensors of the GMSD/GMXD/MSD/MXD...-series without a new calibration being necessary. Therefore a great variety of replaceable sensors of e.g. -1.999...2.500 mbar relative up to 0...1000 bar absolute pressure can be connected to the device.

### 10.1 Absolute Pressure Sensors (types: GMSD/GMXD...BA)

Connect plastic tube with an internal diameter of 4 mm to pressure port "A". (Port "B" is not used.)

### 10.2 Relative Pressure Sensors (types: GMSD/GMXD...MR, GSMD/GMXD...BR)

- **For measurements of over- or under pressure:**

Connect plastic tube with an internal diameter of 4 mm to pressure port "B". (Port "A" is not used.)

- **For measurements of under pressure: (with higher negative measuring range)**

Connect plastic tube with internal diameter of 4 mm to pressure port "B". Port "A" will not be used!

Pressure sensors GMSD 2,5 MR, GMSD 25 MR and GMSD 350 MR allow for measurements of under pressure up to the entire over pressure measuring range by re-plugging the tube to pressure port "A".

Please note that all values are displayed as positive values. No minus sign will be shown. (Example for GMSD 25 MR: For tube connection "B" the measuring range covers -19.99 to 25.00 mbar. If you replug to port "A" under pressure measurements down to -25.00 mbar could be carried out with the display showing the value 25.00 (no minus sign).



**Note: All values are displayed now as positive values. No minus sign will be shown.**

Example: it is possible to measure under pressure down to -25.00 mbar, the display shows then the value 25.00 (no minus sign).

- **For measurements of pressure differences:**

Connect both plastic tubes with an internal diameter of 4 mm to pressure port "B" and "A"; make sure to apply higher pressure to port "B".

### 10.3 Stainless steel pressure sensors (types: GMSD/GMXD...MRE, GMSD/GMXD...BRE, GMSD/GMXD...BAE and MSD/MXD...MRE, MSD/MXD...BRE, MSD/MXD...BAE with MSD-K31)

For measurements of over-, under- or absolute pressure screw sensor to G1/4" pressure terminal or plug plastic tube to a suitable adapter.

## 11 Error And System Messages

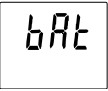
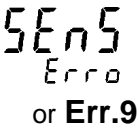
Display	Meaning	What to do?
	Low battery power, device will only continue operation for a short period of time	Replace battery
	Battery empty	Replace battery
	Mains operation without battery: wrong voltage	Check power supply, replace it when necessary
	No sensor connected	Switch off device and connect sensor
	Connected sensor or device defective	If 2nd sensor available, check if device is ok. Return defective device/sensor to manufacturer for repair
	Value extremely out of measuring range	Check: pressure not within sensor range?
No display or confused characters, device does not react on keypress	Battery empty	Replace battery
	Mains operation: wrong voltage or polarity	Check power supply, replace it when necessary
	System error	Disconnect battery and power supplies, wait shortly, then reconnect
	Device defective	Return to manufacturer for repair
<b>Err.1</b>	Measured value above allowable range	Check: pressure not within sensor range? -> measuring value to high!
	Sensor defective	Return to manufacturer for repair
<b>Err.2</b>	Measured value below allowable range	Check: pressure not within sensor range? -> measuring value to low!
	Sensor defective	Return to manufacturer for repair
<b>Err.3</b>	Display range overflow	Check: value above 19999 -> to high to be displayed
<b>Err.4</b>	Display range underflow	Check: value below -19999 (Tara?) -> to low!
<b>Er.11</b>	Value could not be calculated	Choose different unit
	Calculation overflow happened	Choose different unit
<b>Err.7</b>	System error	Return to manufacturer for repair
<b>----</b>	Sensor not present / recognised could not calculate value	Connect suitable sensor

## 12 Specification

### Measuring ranges:

Display range:	max. -19999...19999 digit, depending on connected sensor
Resolution:	depending on connected sensor
Pressure units:	mbar, bar, kPa, MPa, mmHg, PSI, mH <sub>2</sub> O selectable depending on connected sensor
Accuracy: (typ.)	±0,1%FS (at nominal temperature)
Measuring rate:	4 meas./sec
Nominal temperature:	25°C

**Sensor:** All sensors of the GMSD, GMXD, MSD and MXD..-series without recalibration can be connected.

**Connection:** Mini-DIN-Socket with locking mechanism  
The sensor will automatically be detected, the measurement range settings are set referring to sensor data

**Display:** 2 four digit LCDs (12.4 mm high and 7 mm high) for measuring values, and for min/max memories, hold function, etc. as well as additional functional arrows.

**Pushbuttons:** 6 membrane keys

**Output:** 3.5 mm audio plug, stereo

**Interface:** Serial interface (3.5mm jack) can be connected to USB or RS232 interface of a PC via electrically isolated interface adapter USB 3100, USB 3100 N, GRS 3100 or GRS 3105 (see accessories).

**Power supply:** 9V battery, type: IEC 6F22 (included in scope of supply)  
as well as additional d.c. connector (diameter of internal pin 1.9 mm) for external 10.5-12V direct voltage supply.  $\ominus \oplus$  (suitable power supply: GNG10/3000)

**Power consumption:** < 1.6 mA

**Low battery warning:** ' bAt '

**Working conditions:** -20 ... +50 °C, 0 ... 95 %RH (not condensing)

**Storage temperature:** -20 ... +70 °C

**Housing:** impact-resistant ABS, membrane keyboard, transparent panel, Front side IP65

**Dimensions:** 142 x 71 x 26 mm (L x W x D)

**Weight:** approx. 150 g

**EMC:** The instruments conform to following European Directives:

2014/30/EU EMC Directive

2011/65/EU RoHS

Applied harmonized standards:

EN 61326-1 : 2013 emissions level: class B

emi immunity according to table 3 and A.1

Additional fault: <1%

## 13 Reshipment, Disposal and Decommissioning

### 13.1 Reshipment



All devices returned to the manufacturer have to be free of any residual of measuring media and other hazardous substances. Measuring residuals at housing or sensor may be a risk for persons or environment



Use an adequate transport package for reshipment, especially for fully functional devices. Please make sure that the device is protected in the package by enough packing materials.

### 13.2 Disposal instructions



Batteries must not be disposed in the regular domestic waste but at the designated collecting points.



The device must not be disposed in the unsorted municipal waste! Send the device directly to us (sufficiently stamped), if it should be disposed. We will dispose the device appropriate and environmentally sound.

### 13.3 Decommissioning

When decommissioning the device, the pressure connections must not be dismantled under pressure.