

# HS-100IS Intrinsically Safe Accelerometer

## AC acceleration output via 2 Pin MS Connector

### Key Features

- Intrinsically Safe with European, USA, South African, Indian and Australian approvals
- Side entry for easy access

### Industries

Building services, Pulp and Paper, Mining, Metals, Utilities, Automotive, Water, Pharmaceutical

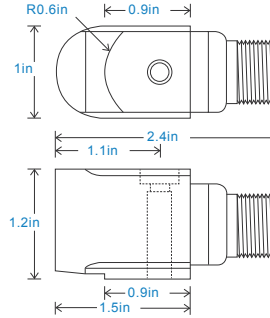

### Connection Details

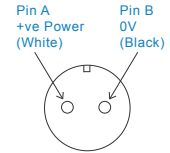

### Technical Performance

Mounted Base Resonance	see 'How To Order' table (nominal)
Sensitivity	see: 'How To Order' table $\pm 10\%$ Nominal 80Hz at 72°F
Frequency Response	120cpm (2Hz) to 600kcpm (10kHz) $\pm 5\%$ 90cpm (1.5Hz) to 720kcpm (12kHz) $\pm 10\%$ 48cpm (0.8Hz) to 900kcpm (15kHz) $\pm 3\text{dB}$
Isolation	Base isolated
Range	see: 'How To Order' table
Transverse Sensitivity	Less than 5%

### Mechanical

Case Material	Stainless Steel
Sensing Element/Construction	PZT/Compression
Mounting Torque	5.9ft. lbs
Mounting Bolt Provided	see: 'How To Order' table x 1.2in long
Weight	6.5 oz. (nominal)
Shielded Cable Assembly	see: <a href="http://www.hansfordsensors.com">www.hansfordsensors.com</a> for options
Connector	HS-AA004 - non-booted HS-AA053 or HS-0054 - booted
Mounting Threads	see: 'How To Order' table

### Electrical

Electrical Noise	0.1mg max
Current Range	0.5mA to 8mA
Bias Voltage	10 - 12 Volts DC
Settling Time	2 seconds
Output Impedance	200 Ohms max.
Case Isolation	$>10^8$ Ohms at 500 Volts

### Environmental

Operating Temperature Range	see: attached certification details
Sealing	IP68
Maximum Shock	5000g
EMC	EN61326-1:2013

### Typical Frequency Response (at 100mV/g)

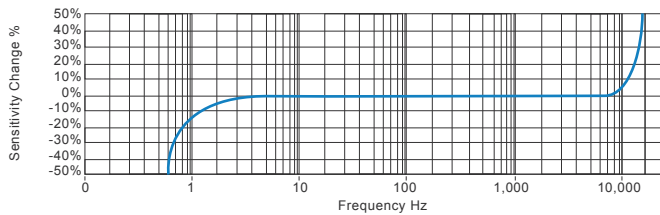

### Applications

Fans, Motors, Pumps, Compressors, Centrifuges, Conveyors, Air Handlers, Gearboxes, Rolls, Dryers, Presses, Cooling, VAC, Spindles, Machine Tooling, Process Equipment

Vibration sensor should be firmly fixed to a flat surface (spot face surface may be needed to be produced and cable anchored to sensor body.)

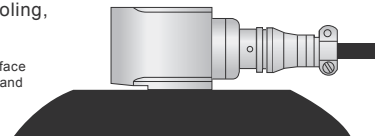

### Certifications



This product is certified in accordance with  
**UL 913, 8th Ed. Rev. December 6, 2013**  
**CAN/CSA C22.2 No. 157-92 (R2012) +Upd1 +Upd2**



[www.hansfordsensors.com](http://www.hansfordsensors.com)  
[sales@hansfordsensors.com](mailto:sales@hansfordsensors.com)



We reserve the right to alter the specification of this product without prior notice  
 TS039U.9

# HS-100IS Intrinsically Safe Accelerometer

## AC acceleration output via 2 Pin MS Connector

### Intrinsically Safe Requirements

Maximum Cable Length	Up to 300 metres dependent on cable - see attached system drawing	Certified Temperature Range	Ex ia IIC T6 Ga (-55°C ≤ Ta ≤ +60°C) (Gas) Ex ia IIIC T80°C IP65 Da (-55°C ≤ Ta ≤ +60°C) (Dust) Ex ia IIC T4 Ga (-55°C ≤ Ta ≤ +110°C) (Gas)* Ex ia IIIC T130°C IP65 Da (-55°C ≤ Ta ≤ +110°C) (Dust)* Ex ia I Ma (-55°C ≤ Ta ≤ +110°C) (Mining) *On request - consult Sales Office
Certificate details: Group I	IECEX BAS07.0037X Baseefa07ATEX0149X ⓈI M1 Ex ia I Ma (-55°C ≤ Ta ≤ +110°C)	ITACS Group I	IECEX ITA 11.0013X Ex ia I Ma (-55°C ≤ Ta ≤ +110°C)
Certificate details: Group II (ignition temperature 130°C)	IECEX BAS07.0035X Baseefa07ATEX0144X ⓈII 1GD Ex ia IIC T4 Ga Ex ia IIIC T130°C IP65 Da (-55°C ≤ Ta ≤ +110°C)	US/Canada Approvals	Certificate No. USTC/15/FAI/01350 Class I, II, III, Division 1, 2, Groups A - G, T4, -55°C to +110°C, IP65 Class I, Zone 0, AEx, ia, IIC, T4, Ga, -55°C to +110°C Zone 20, AEx, ia, IIIC, T130°C, IP65, Da, -55°C to +110°C
Certificate details: Group II (ignition temperature 80°C)	IECEX BAS07.0035X Baseefa07ATEX0144X ⓈII 1GD Ex ia IIC T6 Ga Ex ia IIIC T80°C IP65 Da (-55°C ≤ Ta ≤ +60°C)	Class I, II, III, Division 1, 2, Groups A - G, T6, -55°C to +60°C Class I, Zone 0, AEx, ia, IIC, T6, Ga, -55°C to +60°C Zone 20, AEx, ia, IIIC, T80°C, IP65, DA, -55°C to +60°C	South African Approval
Accelerometer System Certificate	Baseefa07Y0145 Ex ia IIC T6 (-55°C ≤ Ta ≤ +60°C) Ex ia IIC T4 (-55°C ≤ Ta ≤ +110°C) On request - consult Sales Office	System Connections	Certificate No. MASC S/16-0231X Group II (As Baseefa/ATEX) MASC M/16-0230X Group I (As Baseefa/ATEX)
Terminal Parameters	Ui = 28V, Ii = 93mA, Pi = 0.65W Ci = 83nf Li/Ri = 15.4µH/Ohm	Barrier	1 x Pepperl + Fuchs Galvanic Isolator KFD2-VR4-Ex1.26 (BAS02ATEX7206) see attached system drawings 1 x MTL Zener Barrier MTL7728+ (BAS01ATEX7217) or Pepperl + Fuchs Zener Barrier Z728 (BAS01ATEX7005) or any other barrier that conforms to system drawings on website
500V Isolation	Units Will Pass A 500V Isolation Test		

Notes: Special conditions of safe use for Group I & II. The free end of the cable on the integral cable version of the apparatus must be terminated in an appropriate dust-proof enclosure.

### How To Order

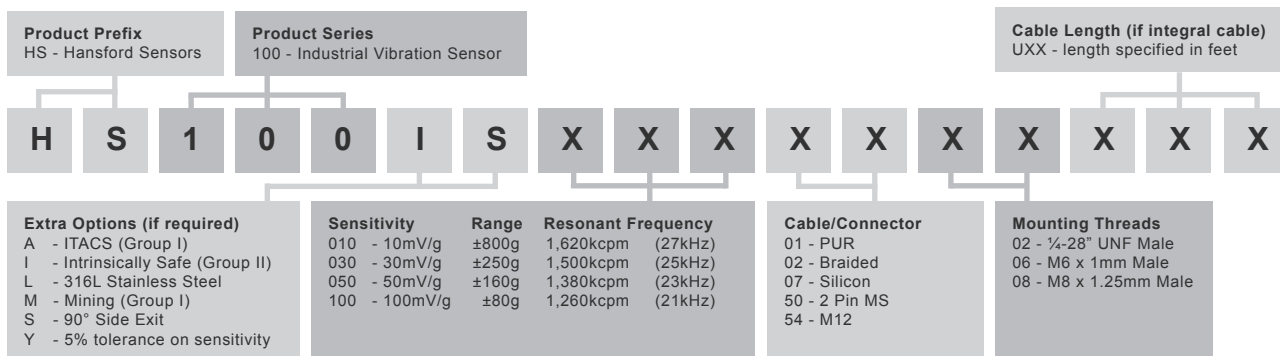

[www.hansfordsensors.com](http://www.hansfordsensors.com)  
[sales@hansfordsensors.com](mailto:sales@hansfordsensors.com)

We reserve the right to alter the specification of this product without prior notice  
TS039U.9



Non-hazardous area apparatus which is unspecified except that it must not be supplied from nor contain under normal or abnormal conditions, a source of potential with respect to earth in excess of 250 volts DC, under normal conditions the potential at the connections to the galvanic isolator must not exceed 40 volts DC.

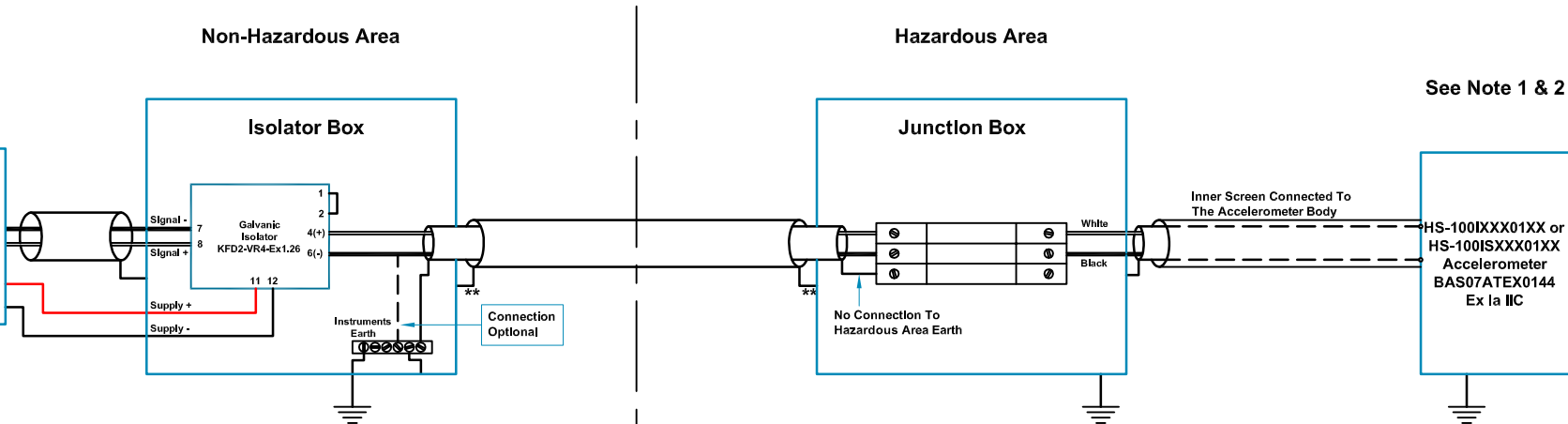

**Table 1: Cable Parameters For Additional Cable Lengths**

Accelerometer With Integral Cable Length ≤ 10m		
Group	Capacitance μF	L/R Ratio μH/Ω
IIC	0.086	46
IIB	0.730	172
IIA	2.470	363
Accelerometer With Integral Cable Length ≤ 50m		
Group	Capacitance μF	L/R Ratio μH/Ω
IIC	0.051	46
IIB	0.695	172
IIA	2.435	363
Accelerometer With Integral Cable Length ≤ 92m		
Group	Capacitance μF	L/R Ratio μH/Ω
IIC	0.013	46
IIB	0.657	172
IIA	2.397	363

**Hansford Sensors Ltd**  
 HS-100I or HS-100IS  
 Accelerometer System  
 Ex ia IIC T4 (-55°C ≤ Ta ≤ +110°C) or  
 Ex Ia IIC T6 (-55°C ≤ Ta ≤ +60°C)

- Notes:**
- The capacitance and inductance, to resistance ratio (L/R) of hazardous area cable, must not exceed the values shown in Table 1.
  - The cable from the accelerometer to the junction box must not be installed in a high velocity dust laden atmosphere
  - The installer is to perform a risk assessment in accordance with clause 10 of EN 60079-25 and install lightning protection arrestors as deemed necessary.

Rev No	DRF No	Date Drg	Drg By	Appd By	Material: N/A
A	Release	15/06/07	MJS	CMH	
					Tolerances Unless Stated
					0 or 0.0 ±0.5
					0.00 ±0.15
					Angle ±5°
					1.6/√ Finish All Over Threads g6 H6

**Hansford Sensors**  
 Excellence in Vibration Monitoring  
 Hansford Sensors Ltd  
 Artisan, Hillbottom Rd  
 Sands Industrial Estate  
 High Wycombe  
 Bucks HP12 4HJ

Do Not Scale  
 All Dimensions In mm Unless Otherwise Stated  
**If In Doubt - Ask!**

Description: System Connections For HS-100I & HS-100IS Group II Accelerometers With 2 Pin MS Connector F.U.W. Galvanic Isolation  
 Drawing No: M06-056-A  
 Scale: NTS  
 Sheet: 1 of 2  
 Form Number: QF024 Issue 1

Non-hazardous area apparatus which is unspecified except that it must not be supplied from nor contain under normal or abnormal conditions, a source of potential with respect to earth in excess of 250 volts rms or 250 volts dc. under normal conditions the potential at the connections to the zener barrier must not exceed 40 volts dc.

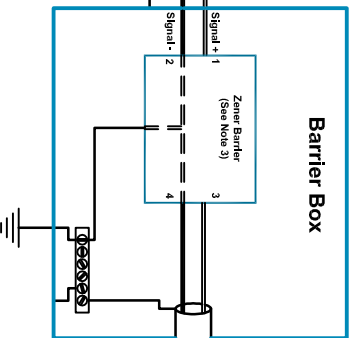

Non-Hazardous Area

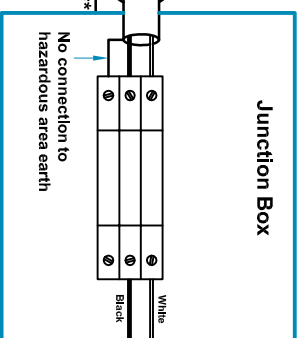

Hazardous Area

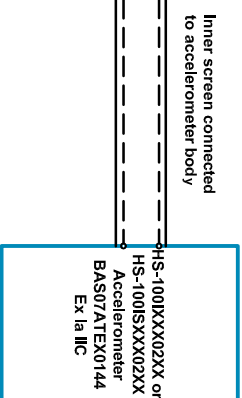

See Note 1 & 2

**Table 1 : Cable Parameters For Additional Cable Lengths**

Accelerometer With Integral Cable Length ≤ 10m		
Group	Capacitance µF	L/R Ratio µH/Ω
IIC	0.073	56
IIB	0.239	168
IIA	0.654	448
Accelerometer With Integral Cable Length ≤ 50m		
Group	Capacitance µF	L/R Ratio µH/Ω
IIC	0.038	56
IIB	0.204	168
IIA	0.619	448
Accelerometer With Integral Cable Length ≤ 92m		
Group	Capacitance µF	L/R Ratio µH/Ω
IIC	0.000	56
IIB	0.166	168
IIA	0.581	448

**Hansford Sensors Ltd**  
 HS-1001 or HS-1001S  
 Accelerometer System  
 Ex ia IIC T4 (-55°C ≤ Ta ≤ +110°C) or  
 Ex ia IIC T6 (-55°C ≤ Ta ≤ +60°C)

**Notes:**

1. The capacitance and inductance, to resistance ratio (L/R) of hazardous area cable, must not exceed the values shown in Table 1.
2. The cable from the accelerometer to the junction box must not be installed in a high velocity dust laden atmosphere.
3. Any single zener diode safety barrier certified by an approved body to [Ex ia] IIC having the following output parameters: Uo = 28V dc, Io = 93mA dc, Po = 0.65W, e.g. MTL7728 to BAS01ATEX7217 or Pepperl + Fuchs Z728 to BAS01ATEX7005.
4. The installer is to perform a risk assessment in accordance with clause 10 of EN 60079-25 and install lightning protection arrestors as deemed necessary.

Rev No	DRF No	Date Drg	Drg By	Appd By	Material: N/A
A	Release	16/09/15	MJS	CMH	

Tolerances Unless Stated					
0 or 0.0 ±0.5					
0.00 ±0.15					
Angle ±5°					



**Hansford Sensors Ltd**  
 Artisan, Hillbottom Rd  
 Sands Industrial Estate  
 High Wycombe  
 Bucks HP12 4HU



Do Not Scale

All Dimensions in mm Unless Otherwise Stated

Description: System Connections For HS-1001 & HS-1001S Group II Accelerometers With 2 Pin M5 Connector F.U.W. Zener Barrier  
 Drawing No: M06-056-A

If In Doubt - Ask!

Scale: NTS  
 Sheet: 2 of 2  
 Form Number: QF024 Issue 1