

# HS-SE-M Switching Enclosure

Mild Steel

## Key Features

- BNC and 2 Pin MS output
- Provides a terminal to take readings from accelerometers via a portable data-collector
- Multiple outputs via one connector
- Easy to install

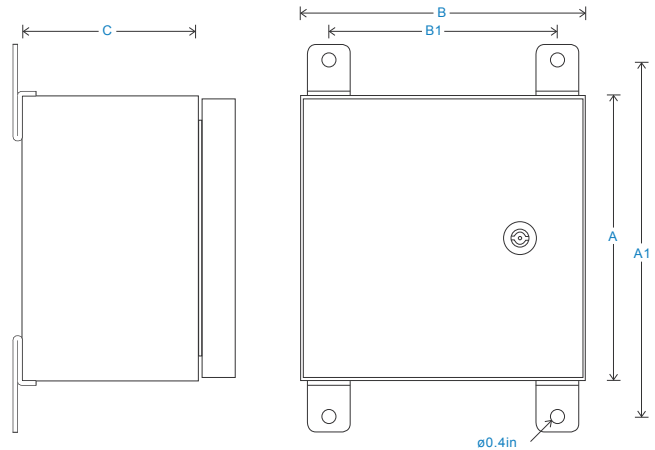

## Technical Performance

Inputs	Via accelerometer	Door	Twist Handle
Output	BNC and 2 Pin MS as standard	Glanding	Glands supplied but not fitted
Mounting Board	PCB Panel	Holes are punched for:	
	(customizable upon request)	Single input M12 - ø0.1-0.3in cable	
Material	Mild Steel painted RAL 7042 as standard (alternatives can be specified in options of 'How To Order' table)	Single input M20 - ø0.3-0.7in multi-core cable	
		Multi input M20 - 3 x ø0.2in	
Dimensions	see: diagram	Labelling	Channel locations - other labelling available upon request
Termination	Spring-loaded terminal (no screwdriver required)	Mounting	supplied are 4 x Brackets
Sealing	NEMA 4X	EMC	EN61326-1:2013

## How To Order

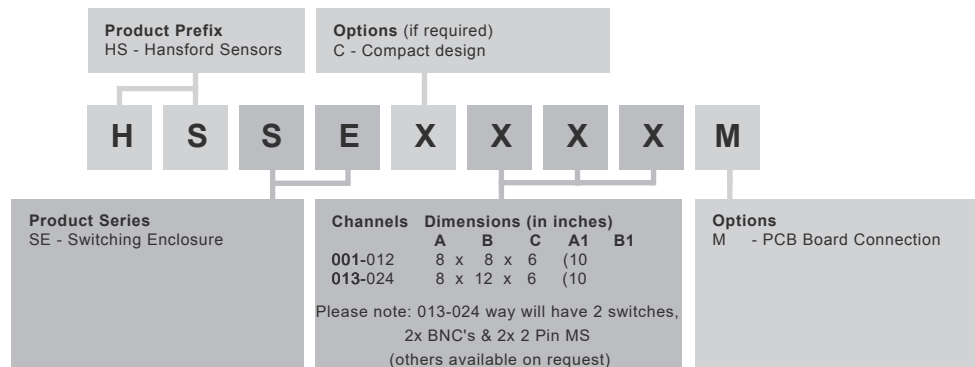

[www.hansfordsensors.com](http://www.hansfordsensors.com)  
[sales@hansfordsensors.com](mailto:sales@hansfordsensors.com)

We reserve the right to alter the specification of this product without prior notice  
TS413U.4

