

ONLINE HELP

# CLV640 Bar Code Scanner



Advanced Line



Software/Tool	Function	Version
Device description CLV640	Device specific software module for configuration software SOPAS-ET	V 3.0
SOPAS-ET	Configuration software	V 2.16

**Copyright**

Copyright © 2008

SICK AG Waldkirch

Auto Ident, Werk Reute

Nimburger Strasse 11

79276 Reute

Germany

**Trademark**

Windows 2000™, XP™, Vista™ and Internet Explorer™ are registered trademarks or trademarks of the Microsoft Corporation in the USA and other countries.

Acrobat™ Reader™ is a trademark of Adobe Systems Incorporated.

## Table of contents

<b>1</b>	<b>Notes on this document</b> .....	<b>5</b>
<b>2</b>	<b>CLV640</b> .....	<b>7</b>
2.1	Quickstart .....	7
2.2	Parameter .....	8
2.2.1	Reading configuration .....	8
2.2.1.1	Object trigger control .....	9
2.2.1.2	Oscillating mirror .....	10
2.2.1.3	Focus control .....	11
2.2.1.4	Illumination control .....	11
2.2.1.5	Dynamic reading configuration .....	12
2.2.2	Increment configuration .....	12
2.2.3	Code configuration .....	13
2.2.3.1	Codabar .....	14
2.2.3.2	Code 39 .....	15
2.2.3.3	UPC/EAN .....	16
2.2.3.4	2/5 Interleaved .....	17
2.2.3.5	Code 93 .....	18
2.2.3.6	Code 128 family .....	19
2.2.3.7	Pharmacode .....	20
2.2.4	Data processing .....	21
2.2.4.1	Output control .....	21
2.2.4.2	Evaluation conditions .....	23
2.2.4.3	Match-code teach-in .....	27
2.2.4.4	Filter/Sorter for output formatting .....	28
2.2.4.5	Output format .....	29
2.2.5	Network / Interface / IOs .....	31
2.2.5.1	Serial .....	32
2.2.5.2	Ethernet .....	33
2.2.5.3	CAN .....	35
2.2.5.4	Digital inputs .....	35
2.2.5.5	RDT400 .....	36
2.2.5.6	Digital outputs .....	36
2.2.5.7	Fieldbus CDF600 .....	38
2.3	Service .....	38
2.3.1	Operating data .....	38
2.3.2	System status .....	39
2.4	Analysis .....	39
2.4.1	Event monitor .....	39

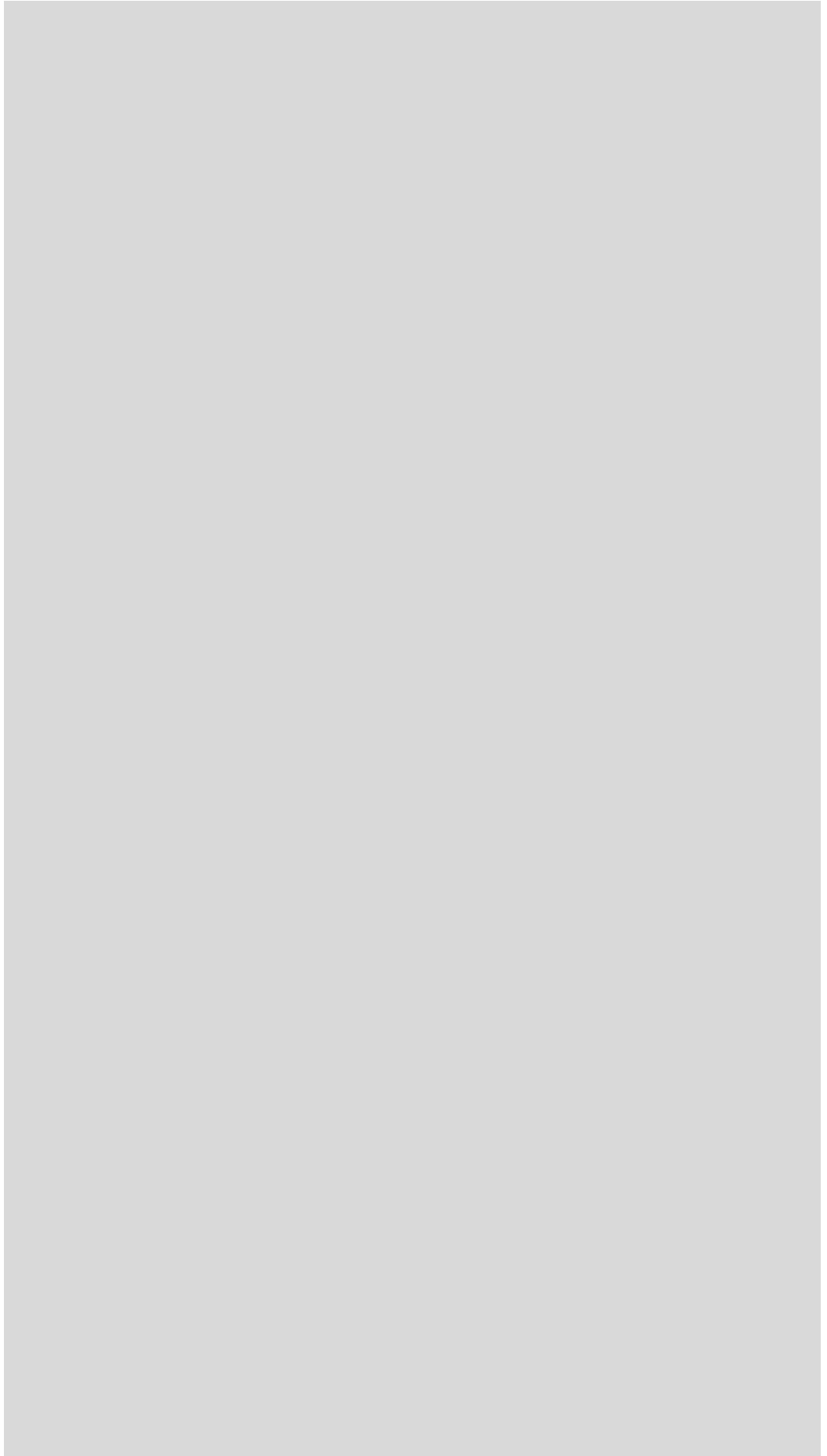

# 1 Notes on this document

**Purpose** This document provides instructions for technical staff on the configuration of the barcode scanner CLV640 with the SOPAS-ET software.

This document provides information to all parameters which are required for the operation of the barcode scanner.

**Target group** The target group of this document is persons entrusted with the following activities:

Activities	Target group
Startup and configuration	Trained staff, e.g. technicians or engineers

Tab. 1-1: Target group

**Depth of information** This document contains all the information required for on-site configuration of the barcode scanner. The **pre-assembled configuration** (basic configuration) of the barcode scanner is set for use as a **stand-alone device**.

Information on mounting, installation, maintenance and troubleshooting are listed in the operating instructions of the barcode scanner (document no. 8011975).

**Important** Further information on the design of the barcode scanner as well as the barcode technology is available from SICK AG, Auto Ident division.

On the Internet at [www.sick.com](http://www.sick.com).

**Used symbols** To provide easier access some information in this document is emphasised as follows:

**Reference** Blue underlined font shows a reference to more detailed information.



This symbol refers to special features.



This symbol refers to additional settings in the configuration software SOPAS-ET.



This symbol refers to additional technical documents.



## 2 CLV640

### 2.1 Quickstart

**Quickstart** The parameters of the *Quickstart* group are used to set the code type and the scan frequency. Furthermore, the code reading process can be started and evaluated manually.

Parameter	Function
Device type	The barcode scanner type is displayed.
Device ID	Enter address of the device in the CAN net.
Barcode content	Last read barcode is displayed.
Code ID	Abbreviation of the code type of the last read barcode is displayed.
Code length	Length of the latest read barcode is displayed.
Start	Start code reading process.
Stop	Stop code reading process.
Percent evaluation	The percentage of the successful code readings per 100 scans is displayed and visualised via a green bar. The percent evaluation is stopped if an external trigger (data interface or switching input) occurs during the percent evaluation. The percentage related to the actual number of scans on the code is displayed.
Codabar	Activate/deactivate decoding of code type CODABAR (see also <a href="#">chapter 2.2.3 Code configuration, page 13</a> ).
Code 39	Activate/deactivate decoding of code type CODE 39 (see also <a href="#">chapter 2.2.3 Code configuration, page 13</a> ).
UPC/EAN	Activate/deactivate decoding of code type UPC/EAN (see also <a href="#">chapter 2.2.3 Code configuration, page 13</a> ).
2/5 Interleaved	Activate/deactivate decoding of code type 2/5 INTERLEAVED (see also <a href="#">chapter 2.2.3 Code configuration, page 13</a> ).
Code 93	Activate/deactivate decoding of code type CODE 93 (see also <a href="#">chapter 2.2.3 Code configuration, page 13</a> ).
Code 128 family	Activate/deactivate decoding of code family CODE 128 (see also <a href="#">chapter 2.2.3 Code configuration, page 13</a> ).
Scan frequency	Select the recommended scan frequency for the respective reading situation (see also <a href="#">chapter 2.2.1 Reading configuration, page 8</a> ).
Auto-Setup	... By using Auto-Setup some parameters are changed and stored in the device permanently.
more...	Call up the <a href="#">Reading configuration</a> group to set additional reading parameters.
Don't show this dialog on adding device	The <i>Quickstart</i> group is displayed as initial dialog automatically. You can activate/deactivate this function here.

**Important** Default values, min. and max. values are displayed at PARAMETER INFO on the SOPAS-ET interface.

## 2.2 Parameter

**General** Activate/deactivate password protection via the parameters of the [General](#) group.

Parameter	Function
Parameterisation is protected by password	Activate/deactivate password protection. If the password protection has been activated, the password must be entered during login (password: "client"). The password cannot be altered.

### 2.2.1 Reading configuration

**Codelabel properties** The parameters of the [Codelabel properties](#) group are used to set the reading parameters and the barcode properties.

Parameter	Function
Scan frequency	Select the recommended scan frequency for the respective reading situation. The scan frequency depends on the codelabel distance and the module width of the barcode. Also see the frequency diagram in the operating instructions.
Quietzone ratio	Select ratio between quiet zone (white area before and after the barcode) and the code's spaces.
Barcode quality	Select the average barcode quality. (Only deviates from the "STANDARD" setting if the barcode has imperfections or is poorly printed.)
Codelabel distance	Only for PHARMACODE code types: Enter the distance between the scanner and the barcode and select the unit.
Minimum reading angle	Enter the lower limit of the reading area. 0 = start of reading area 50 = middle of reading area 100 = end of reading area
Maximum reading angle	Enter the upper limit of the reading area. 0 = start of reading area 50 = middle of reading area 100 = end of reading area
Enable dynamic reading configuration	Activate/deactivate dynamic reading configuration. The parameters of the <a href="#">Codelabel properties</a> group can be grouped into up to eight configurations. The organization of the configurations is done on page <a href="#">chapter 2.2.1.5 Dynamic reading configuration, page 12</a> .



2.2.1.1 Object trigger control

**Start/Stop of object trigger** The trigger source is configured with the parameters of the *Start/Stop of object trigger* group.

Parameter	Function
Control	Select type of control (based on time or path via incremental encoder <a href="#">chapter 2.2.2 Increment configuration, page 12</a> ).
Start delay	Enter delay between start trigger and the opening of reading gate. Select possible delay unit. Select source of start trigger.
From	Enter the CAN address of the device from which the start trigger is derived. For this device, "CAN" must be selected for the TRIGGER DISTRIBUTION.
Stop delay	Enter delay between start trigger and the closing of reading gate. Select possible delay unit. Select source/operation of stop trigger.
OR	Select further source/operation of stop trigger (optional). This source is linked to the first source by a logical OR.
OR	Select further source/operation of stop trigger (optional). This source is linked to both previous sources by a logical OR.
Pulse	Enter length of pulse for automatic pulse. If applicable, select unit.
Pause	Enter pause length between two pulses of the automatic pulse. If applicable, select unit.
Duration	Enter time/path after which a stop trigger is to be initiated. If applicable, select unit.

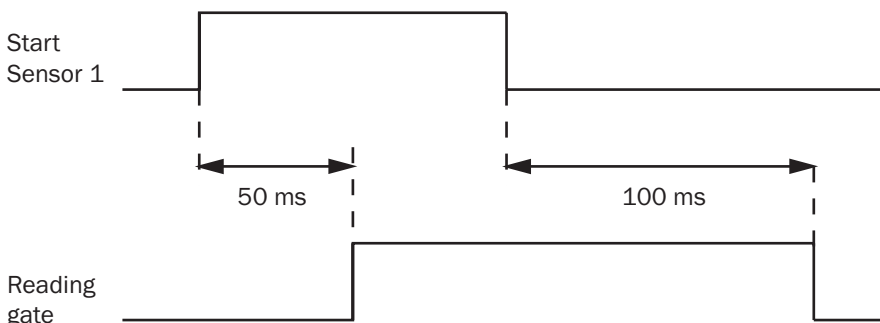
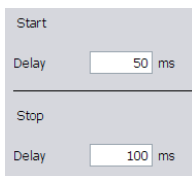

Fig. 2-1: Impact of the parameters Start delay and Stop delay on the reading gate.

**Trigger distribution** The trigger receiver is configured via the parameters of the *Trigger distribution* group.

Parameter	Function
Distribute on	Select trigger receiver. If the trigger is distributed via CAN, "CAN" must be indicated as the source of the trigger at the trigger receiver.

### 2.2.1.2 Oscillating mirror

**Oscillating mirror** The position of the oscillating mirror's movements along the code angle is configured via the parameters of the *Oscillating mirror* group. That way the position of the scan line can be changed.

Parameter	Function
Oscillating mirror mode	Select the mode for the oscillating mirror.
Dynamic configuration	Activate/deactivate dynamic oscillating mirror configuration ( <i>chapter Oscillating mirror dyn. config., page 10</i> ).
more...	Call up the page <i>chapter 2.2.1.5 Dynamic reading configuration, page 12</i> where the configuration is done.
Amplitude 1	Enter the maximum <b>positive</b> oscillation of the oscillating mirror for continuous oscillation (oscillating mirror mode CONTINUOUS). Select possible oscillation unit.
Amplitude 2	Enter the maximum <b>negative</b> oscillation of the oscillating mirror for continuous oscillation (oscillating mirror mode CONTINUOUS). Select possible oscillation unit.
Periodic time	Enter the periodic time for continuous oscillation (oscillating mirror mode CONTINUOUS).
Ratio Phase1/Phase2	Enter the ratio between positive and negative oscillation for continuous oscillation (oscillating mirror mode CONTINUOUS). This value determines the periodic time in per cent.
Start position	Select fixed position of the oscillating mirror (oscillating mirror mode FIX POSITION or CONTROLLED). AMPLITUDE 1 = 20° AMPLITUDE 2 = -20° Both values are independent of the preset value for the CONTINUOUS oscillating mirror mode.
Position	Enter any position of the oscillating mirror between AMPLITUDE 1 and AMPLITUDE 2. If applicable, select unit.
Start condition	Select the start condition for the movements of the oscillating mirror (oscillating mirror mode CONTROLLED).
Stop condition	Select the stop condition for the movements of the oscillating mirror (oscillating mirror mode CONTROLLED).

**Oscillating mirror dyn. config.** The parameters of the *Oscillating mirror dyn. config.* group can be used to group the parameters of the *Oscillating mirror* group into up to eight configurations depending on the oscillating mirror mode.

The organization of the configurations is done on page *chapter 2.2.1.5 Dynamic reading configuration, page 12*.

### 2.2.1.3 Focus control

**Options** The focus position of the bar code scanner is set via the parameter of the [Options](#) group.

Parameter	Function
Default position	Enter the focus position (distance of the lens focal point before the reading window of the bar code scanner). If applicable, select unit.
Focus control mode	Select fix or dynamic focus position. <ul style="list-style-type: none"> <li>• The DEFAULT POSITION parameter determines the focus position for FIX FOCUS.</li> <li>• The values for DYNAMIC FOCUS are determined by the <a href="#">Dyn. focus control</a> group.</li> </ul>

**Dyn. focus control** Up to eight focus position can be defined via the parameters of the [Dyn. focus control](#) group, which can be assigned dynamically.

The assignment is done on page [chapter 2.2.1.5 Dynamic reading configuration, page 12](#).

### 2.2.1.4 Illumination control

**Laser settings** The max. activation time of the laser can be set via the parameters of the [Laser settings](#) group.

Parameter	Function
Laser timeout	Activate/deactivate the max. activation time of the laser. The laser is deactivated after the defined time, even if the reading gate has not been closed.

### 2.2.1.5 Dynamic reading configuration

For a dynamic reading configuration the parameters of the following groups can be grouped into up to eight configurations.

- Codelabel properties (reading configuration)
- Options (focus control)
- Oscillating mirror

**Dyn. rd. config. settings** The assignment table and the assignment's behavior are configured via the parameters of the *Dyn. rd. config. settings* group.

Parameter	Function
Dynamic control mode	Select the source for assigning the dynamic reading configuration.
Behavior	Select the behavior for assigning the dynamic reading configuration.
Timer	Enter the time span required for changing to the next configuration.

**Dyn. reading config. assignment table** The number and order of configurations for the dynamic reading configuration is determined via the parameters of the *Dyn. reading config. assignment table* group.

Parameter	Function
Assignment table length	Enter the number of configurations that are assigned.
Index 0..7	Set the order for assigning the configurations.

### 2.2.2 Increment configuration

An external **incremental encoder** can be connected to determine the actual conveyor speed. The conveyor speed is the result of the number of impulses multiplied by the resolution of the external incremental encoder per time.

Alternatively, a fixed speed can be selected.

**Increment** The increment source and the resolution/speed are configured via the parameters of the *Increment* group.

Parameter	Function
Increment source	Select increment source.
Fixed speed	Enter speed of the conveyor distance. If applicable, select unit.
System increment resolution	Enter resolution of the external incremental encoder. If applicable, select unit.

### 2.2.3 Code configuration

**Symbologies** Use the parameters of the *Symbologies* group to activate/deactivate decoding of the code types.

This enables you to filter which code types are to be read:

- Codabar
- Code 39
- UPC/EAN
- 2/5 Interleaved
- Code 93
- Code 128 family
- Pharmacode

The activated code types can be configured individually. For this purpose, separate pages are available in the SOPAS-ET configuration software.

Parameter	Function
Codabar	Activate/deactivate decoding of code type CODABAR Configuration see <a href="#">chapter 2.2.3.1 Codabar, page 14</a>
Code 39	Activate/deactivate decoding of code type CODE 39 Configuration see <a href="#">chapter 2.2.3.2 Code 39, page 15</a>
UPC/EAN	Activate/deactivate decoding of code type UPC/EAN Configuration see <a href="#">chapter 2.2.3.3 UPC/EAN, page 16</a>
2/5 Interleaved	Activate/deactivate decoding of code type 2/5 INTERLEAVED Configuration see <a href="#">chapter 2.2.3.4 2/5 Interleaved, page 17</a>
Code 93	Activate/deactivate decoding of code type CODE 93 Configuration see <a href="#">chapter 2.2.3.5 Code 93, page 18</a>
Code 128 family	Activate/deactivate decoding of code family CODE 128 Configuration see <a href="#">chapter 2.2.3.6 Code 128 family, page 19</a>
Pharmacode	Activate/deactivate decoding of code type PHARMACODE. Configuration see <a href="#">chapter 2.2.3.7 Pharmacode, page 20</a> With this code type the reading distance must be entered (see <a href="#">chapter 2.2.1 Reading configuration, page 8</a> ). All the other code types are locked via activation of the code type PHARMACODE.

### 2.2.3.1 Codabar

The code type CODABAR is used for photo finishing and blood bottle labelling applications. It consists of a character set of 16 characters (10 digits, 6 special characters).



Fig. 2-2: Codabar example

**General** The reading conditions for code type CODABAR are configured via the parameters of the [General](#) group.

Parameter	Function
Multireads	Enter the minimum number of required successful readings that must be achieved to accept a barcode as valid.
Start/Stop identically	Set whether only barcodes with identical start and stop characters are to be read.
Transmit start/stop	Activate/deactivate output of the start and stop character together with code content.
Check-digit test	Select the type of check-digit test.

**Length** A length test of the barcode can be configured via the parameters of the [Length](#) group.

Parameter	Function
Code length mode	Select type of code length test.
Interval	Enter minimum length of barcode. Enter maximum length of barcode. Only barcodes with lengths between these two values are read.
Fixed lengths	Enter required lengths of the barcode. Only barcodes with the entered lengths are read.

### 2.2.3.2 Code 39

The CODE 39 can decode 43 characters. The symbology of the binary Code 39 character set consists of 10 digits, 26 alphabetic characters and 7 special characters. Each character consists of 9 elements (5 bars and 4 spaces). Three of the elements are wide and six are narrow. CODE 39 requires a lot of printing space.



Fig. 2-3: Example of Code 39

**General** Reading conditions for code type CODE 39 are configured via the parameters of the [General](#) group.

Parameter	Function
Multireads	Enter the minimum number of required successful readings that must be achieved to accept a barcode as valid.
Transmit start/stop	Activate/deactivate output of the start and stop character together with code content.
Full ASCII	Activate/deactivate output of the barcode in ASCII.
Check-digit test	Select the type of check-digit test.

**Length** A length test of the barcode can be configured via the parameters of the [Length](#) group.

Parameter	Function
Code length mode	Select the type of code-length test.
Interval	Enter minimum length of barcode. Enter maximum length of barcode. Only barcodes with lengths between these two values are read.
Fixed lengths	Enter required lengths of barcode. Only barcodes with the entered lengths are read.

### 2.2.3.3 UPC/EAN

The UPC (UNIVERSAL PRODUCT CODE) is used for food and consumer goods in the USA and Canada. It can be compared with the European EAN. The UPC is a numeric code with 12 digits (UPC A) or with 6 digits (UPC E). The last digit is the check-digit.



Fig. 2-4: Example of UPC

The EAN (EUROPEAN ARTICEL NUMBERING) is used for labelling food and consumer goods in Europe. It can be compared with the American UPC. The first two numbers indicate the country code, the following numbers the manufacturer and the article. The EAN code is a numeric code with 13 or 8 digits. The last two digits are always used as check-digits.



Fig. 2-5: Example of EAN 13

The UPC A is compatible with EAN 13: If EAN 13 is printed with a 0 (zero) as the first digit, this code has the same bar sequences as the UPC A code. This type of code is decoded as a 12-digit UPC A code in the evaluation routing of the EAN 13 and UPC A. The scanner only decodes this 12-digit codes as UPC A, if UPC A or UPC A and EAN 13 are activated. The code is only interpreted as EAN 13 with a leading zero if EAN 13 is activated.

**General** Reading conditions for code types UPC and EAN are configured via the parameter of the *General* group.

Parameter	Function
Multireads	Enter the minimum number of required successful readings that must be achieved to accept a barcode as valid.
Add-on	Select type of output of the Add-on code. The Add-on code is a small additional code that can be added to the right-hand side of the UPC code. It can consist of 2 or 5 digits.
Add-on-length	Select the length of the Add-on code.

**UPC** Via the parameters of the *UPC* group you can set which UPC code types are to be scanned.

Parameter	Function
UPC A	Activate/deactivate scanning of code type UPC A.
UPC E	Activate/deactivate scanning of code type UPC E.
UPC E Extended	Activate/deactivate scanning of code type UPC E EXTENDED.



**EAN** Via the parameters of the [EAN](#) group you can set which EAN code types are to be scanned.

Parameter	Function
EAN 8	Activate/deactivate scanning of code type EAN 8.
EAN 13	Activate/deactivate scanning of code type EAN 13.

#### 2.2.3.4 2/5 Interleaved

The 2/5 INTERLEAVED (also called ITF) is a very common code type for the coding of numeric information. The main fields of application are in the industrial sector. The 2/5 INTERLEAVED is a binary code which encodes digits from 0-9.



Fig. 2-6: Example of 2/5 Interleaved

**General** The reading conditions for code type 2/5 INTERLEAVED are configured via the parameters of the [General](#) group.

Parameter	Function
Multiread #1	Enter the minimum number of required successful readings that must be achieved to accept a barcode as valid.
Check-digit test #1	Select the type of check-digit test for the first code length.
Check-digit test #2	Select the type of check-digit test for the second code length.
Check-digit test #3	Select the type of check-digit test for the third code length.
Check-digit test #4	Select the type of check-digit test for the fourth code length.
Check-digit test #5	Select the type of check-digit test for the fifth code length.
Classification restriction	The classification restriction is displayed in %. The classification restriction represents the scanning security. The higher the value, the safer the scanning; but it also increases the chance that a poorly printed code will not be scanned. The difference between the smallest wide element and the largest narrow element must be greater than the average module width multiplied by the classification restriction.

**Length** A length test of the barcode can be configured via the parameters of the [Length](#) group.

Parameter	Function
Code length mode	Select the type of code length test.
Interval	Enter minimum length of barcode. Enter maximum length of barcode. Only barcodes with lengths between these two values are read.
Fixed lengths	Enter required lengths of barcode. Only barcodes with the entered lengths are read.

### 2.2.3.5 Code 93

CODE 93 is an alphanumeric code comparable with CODE 39 (see [chapter 2.2.3.2 Code 39, page 15](#)). However, Code 93 requires less space. The same character set (10 numbers, 26 alphabetic characters and 7 special characters) can be encoded. The code is multiple-valued (valency 4).



Fig. 2-7: Example of Code 93

**General** Reading conditions for code type CODE 93 are configured via the parameters of the [General](#) group.

Parameter	Function
Multireads	Enter the minimum number of required successful readings that must be achieved to accept a barcode as valid.

**Length** A length test of the barcode can be configured via the parameters of the [Length](#) group.

Parameter	Function
Code length mode	Select the type of code-length test.
Interval	Enter minimum length of barcode. Enter maximum length of barcode. Only barcodes with lengths between these two values are read.
Fixed lengths	Enter required lengths of barcode. Only barcodes with the entered lengths are read.

**2.2.3.6 Code 128 family**

The CODE 128 is an alphanumeric code that can display the complete ASCII character set with three character sets (set A, B and C). A check-digit test is always available.

- Character set A includes digits, uppercase letters and special characters.
- Character set B includes digits, uppercase and lowercase letters.
- Character set C only includes digits, but with a double density.

It is possible to start with one of these sets and to switch to another character set within the code. CODE 128 is multiple-valued (valency 4).

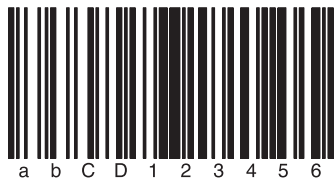

Fig. 2-8: Example of Code 128

**General** The reading conditions for the code family CODE 128 are configured via the parameters of the *General* group.

Parameter	Function
Code 128	Activate/deactivate scanning of code type CODE 128.
EAN 128	Activate/deactivate scanning of code type EAN 128.
Multireads	Enter the minimum number of required successful readings that must be achieved to accept a barcode as valid.

**Length** A length test of the barcode can be configured via the parameters of the *Length* group.

Parameter	Function
Code length mode	Select the type of code length test.
Interval	Enter minimum length of barcode. Enter maximum length of barcode. Only barcodes with lengths between these two values are read.
Fixed lengths	Enter required lengths of barcode. Only barcodes with the entered lengths are read.

**EAN 128** The function characters FC1 are assigned via the parameters of the [EAN 128](#) group. These function characters identify the code as code type EAN 128. They can be at the beginning or in the middle of the code.



Fig. 2-9: Example of EAN 128

Parameter	Function
FC1 value at first position	Enter FC1 values that have to be positioned at the beginning of codes that are to be read.
FC1 value within the code	Enter FC1 values that have to be positioned in the middle of codes that are to be read.

### 2.2.3.7 Pharmacode

The pharmacode is used exclusively in the pharmaceutical industry. It is a binary code, the narrow and wide bars represent the code content (narrow bars = 0 and wide bars = 1). The spacings do not contain information.



If the code type PHARMACODE shall be read, the READING DISTANCE must be entered (see [chapter 2.2.1 Reading configuration, page 8](#)).

**General** Use the parameters of the group [General](#) to configure the reading conditions for the code type PHARMACODE.

Parameters	Function
Multireads	Enter the minimum number of required successful readings that must be achieved to accept a barcode as valid.
Module width	Select the type of module width scanning. If applicable, enter fixed module width.
Backwards	Activate / deactivate reading of the code in the opposite direction.

**Length** Use the parameters of the group [Length](#) to configure testing of the barcode length.

Parameters	Function
Length	Enter required length of barcode. For safety reasons, only pharmacodes with at least four digits can be read.

**2.2.4 Data processing**

**Tracking** The delay for the transmission of the reading data can be configured via the parameters of the *Tracking* group. This can make sense if a code is scanned just before the end of the reading gate.

Parameter	Function
Time out	Enter maximum time after which a read code will be output after the end of the reading gate.

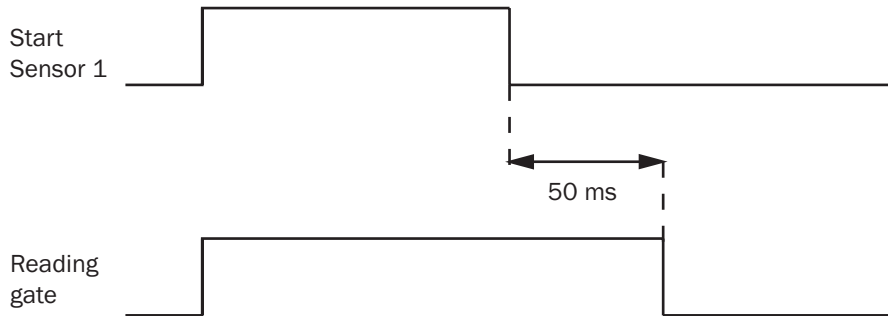
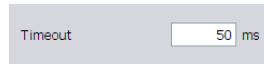

Fig. 2-10: Impact of the Timeout parameters on the reading gate

**Code summarisation** The parameters of the *Code summarisation* group are used to configure whether several similar codes are output as one code or as several codes.

Parameter	Function
Separate codes based on position	Activate/deactivate the output of similar codes as several codes.
Code distance	Enter maximum distance of codes from each other. If applicable, select unit.

**2.2.4.1 Output control**

**Output control** The output of the read code contents is configured with the parameters of the *Output control* group.

Parameter	Function
Control	Select type of control.
Output time	Select output time of the read code contents.
Delay	Enter delay between end of reading gate and output of the code contents. If applicable, select unit.
Output condition	Select required condition for the output of the code contents. This condition can be configurated (see <i>chapter 2.2.4.2 Evaluation conditions, page 23</i> ).
Time out	Enter delay for the transmission of the reading data. If applicable, select unit.

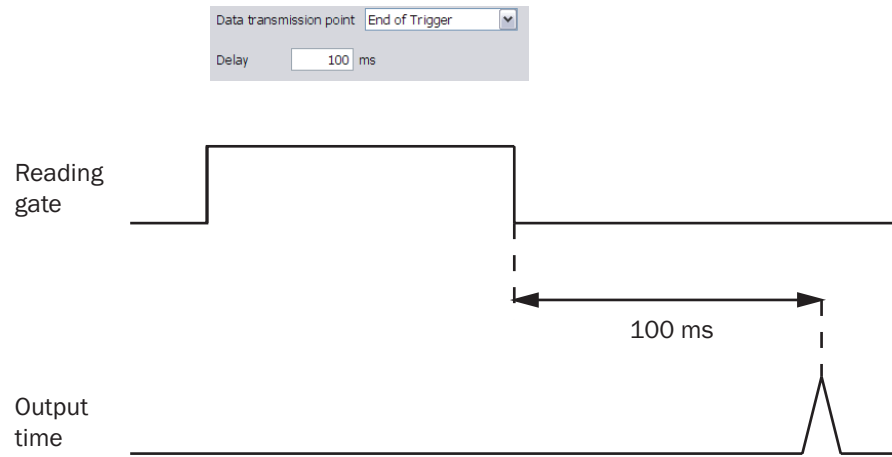

Fig. 2-11: Impact of the parameter values End of trigger (Output time) on the output time of the code contents.

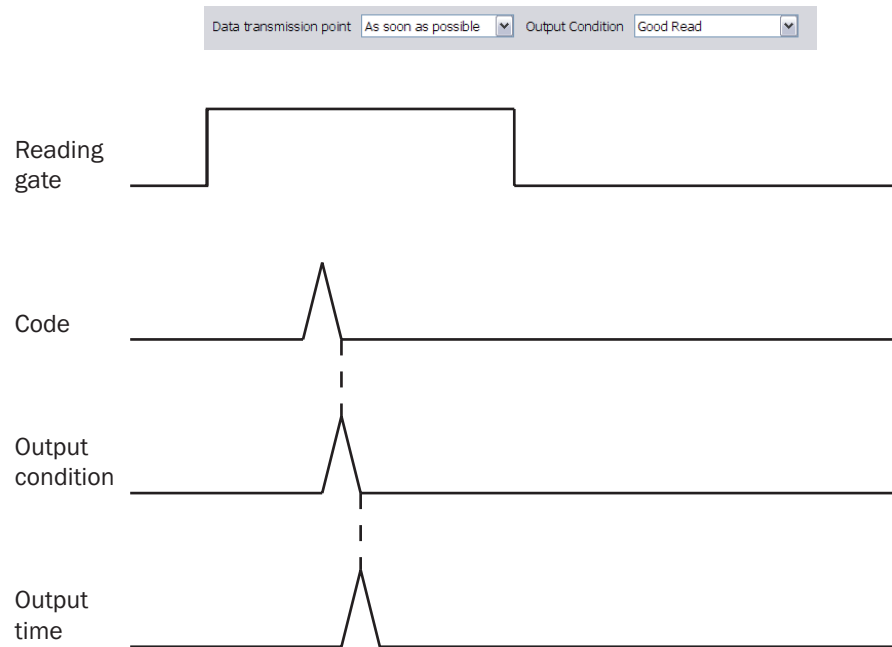

Fig. 2-12: Impact of the parameter value As soon as possible (Output time) on the output time of the code contents.

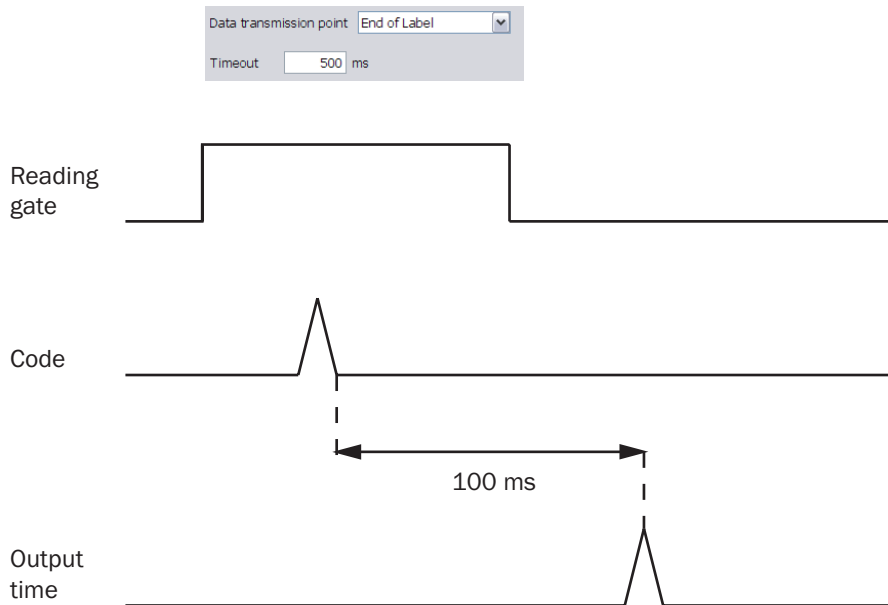





Fig. 2-13: Impact of the parameter values End of label (Output time) on the output time of the code contents.

**2.2.4.2 Evaluation conditions**

**Condition for Good Read** The properties of the criterion GOOD READ are defined via the parameters of the *Condition for Good Read* group.

Parameter	Function
Criterion for Good Read	Select condition for valid code.
Check minimum number of valid codes	Activate/deactivate test of minimum number of valid codes per reading gate.
Minimum	Enter minimum number of valid codes which must be scanned to be transmitted.
Check maximum number of valid codes	Activate/deactivate test of maximum number of valid codes per reading gate.
Maximum	Enter maximum number of valid codes which must be scanned to be transmitted.

**Evaluation conditions** The conditions are managed in the *Evaluation conditions* group. It is possible to define up to 48 conditions.

Parameter	Function
Conditions	 Edit condition.  Delete condition.  Create new condition.

**Create/Edit condition** Conditions can be created and edited in this window.

Parameter	Function
Condition type	Select the type of condition.
Name	Enter a name for the condition.
Deactivate condition	Activate/deactivate bridging of the condition, e. g. for test purposes. Select the type of bridging.
OK	Close window and confirm entries. This button is greyed out as long as all the codes match the condition.
Cancel	Close window and reject entries.

**Match code condition** A default condition is defined with the parameters in the [Match code condition](#) window.



If the background of a field is red, it is filled out incorrectly.

Parameter	Function
Code content	Enter term that describes the content of the desired code.
>	Select predefined term.
Wildcards (? and *)	Select wildcards to describe the desired code content.
Regular expression	Select regular expression to describe the desired code content.
Test...	Tests whether the desired code matches the condition.
Min:	Enter minimum code length.
Max:	Enter maximum code length.
Don't care	Activate/deactivate the code length check.
Code type:	Select desired code type.
Don't care	Activate/deactivate the code type check.
Code validity	Select whether a condition applies only to valid codes or to all codes.
Limitation on devices with ID	Enter the device IDs of the devices for which this condition should be applied.
Invert condition	Activate/deactivate inversion of the condition.



**Free condition** A free condition is defined with the parameters in the *Free condition* window.

Parameter	Function
Add field	Define a part condition.
Modify field	Edit a part condition.
AND	Link two part conditions with a logical AND operation. If both part conditions are true, then the result is true, otherwise, the result is false.
OR	Link two part conditions with a logical OR operation. If one or both part conditions are true, then the result is true, otherwise, the result is false.
Excl. OR	Link two part conditions with a logical XOR (Exclusive OR) operation. If exactly one condition is true, then the result is true, otherwise, the result is false.
NOT	If the following part condition is true, the result is false.
(	Add bracket around part conditions.
)	Add bracket around part conditions.
Remove row	Remove part condition or link between two part conditions. Rows can also be shifted by drag & drag.

**Combination condition** Several conditions can be combined via the parameters in the *Combination condition* window.

Parameter	Function
Add condition	Select a previously defined condition for linking with other conditions.
AND	Link two conditions with a logical AND operation. If both conditions are true, then the result is true, otherwise, the result is false.
OR	Link two conditions with a logical OR operation. If one or both conditions are true, then the result is true, otherwise, the result is false.
Excl. OR	Link two conditions with a logical XOR (Exclusive OR) operation. If exactly one condition is true, then the result is true, otherwise, the result is false.
NOT	If the condition is true, the result is false.
(	Add bracket around part conditions.
)	Add bracket around part conditions.
Remove row	Remove part condition or link between two conditions.

**Example** Conditions for the following example:

- Output of barcodes of code type Code 128 that contain the character sequence "45".
- Condition is met: output of "MATCHCODE" and the code content in the output string.
- Condition is not met: output of "NOMATCH" in the output string.
- No valid code could be read: output of "NoRead" in the output string.

In order to achieve such a result the following CONDITION and an appropriate OUTPUT FORMAT must be created (see [chapter 2.2.4.5 Output format, page 29](#)).

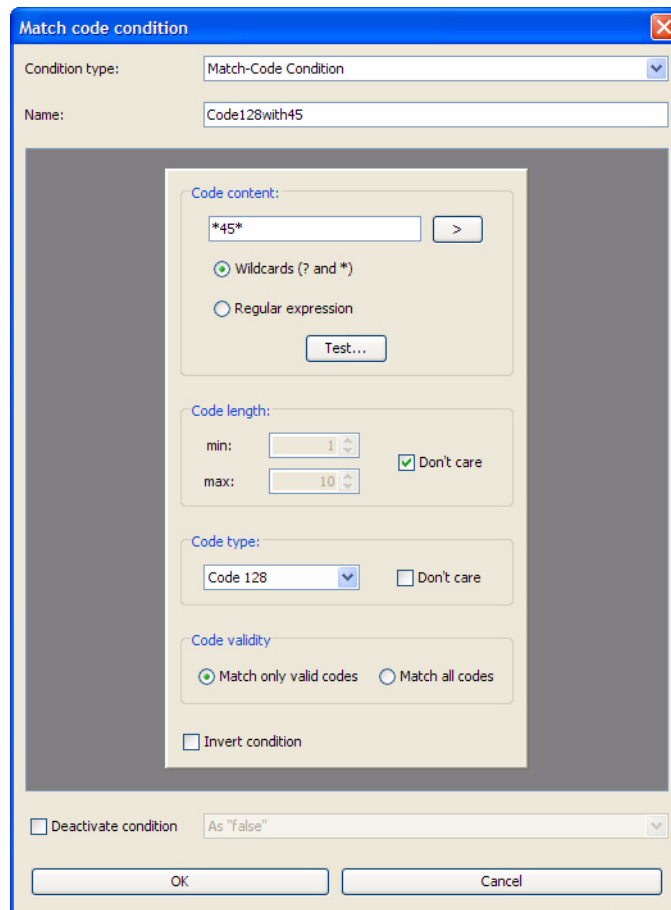

### 2.2.4.3 Match-code teach-in

Read-in the respective templates to define (teach-in) the evaluation conditions "TeachIn1" and "TeachIn2".

It is possible to modify the evaluation conditions after teach-in (see [chapter 2.2.4.2 Evaluation conditions, page 23](#)).

**Match-code teach-in 1 (standard)** Use the parameters of the [Match-code teach-in 1 \(standard\)](#) group to define the settings for the teach-in of the first evaluation condition.

Parameter	Function
Target evaluation condition	Select evaluation condition that will be teach-in.
Invert condition	Activate/deactivate whether evaluation condition will be logically inverted.
Teach-in triggered from	Select trigger source for teach-in of evaluation condition.
Teach-in triggered by buttons	Activate/deactivate button on bar code scanner as trigger source.
Teach-in code content	Activate/deactivate teach-in of code content.
Teach-in code ID (type)	Activate/deactivate teach-in of code ID.
Teach-in code length	Activate/deactivate teach-in of code length.

**Match-code teach-in 2 (additional)** Use the parameters of the [Match-code teach-in 1 \(standard\)](#) group to define the settings for the teach-in of a second evaluation condition.



Parameter	Function
Target evaluation condition	Select evaluation condition that will be teach-in.
Invert condition	Activate/deactivate whether evaluation condition will be logically inverted.
Teach-in triggered from	Select trigger source for teach-in of evaluation condition.
Teach-in code content	Activate/deactivate teach-in of code content.
Teach-in code ID (type)	Activate/deactivate teach-in of code ID.
Teach-in code length	Activate/deactivate teach-in of code length.

**General match-code teach-in settings** Use the parameters of the [General match-code teach-in settings](#) group to define conditions and effects for teach-in.

Parameter	Function
Use teach-in trigger as object trigger	Trigger source for teach-in of evaluation condition also serves as an object trigger.
Object trigger required	In addition to the trigger source for the teach-in of the evaluation condition the start of the object trigger is necessary as well ( <a href="#">chapter 2.2.1.1 Object trigger control, page 9</a> ).
Don't change code config.	The settings of the <a href="#">Code configuration</a> group will not be changed.
Limit code config. to last taught in code	With activated function, only the taught in codes are set to active (see <a href="#">chapter 2.2.3 Code configuration, page 13</a> ).
Expand code config. by last taught in code	The settings of the <a href="#">Code configuration</a> group will be automatically adapted during teach-in.
Save permanent	Activate/deactivate whether the taught in evaluation conditions will be saved permanently in the PROM of the bar code scanner (as well as on the Micro SD memory card and / or the permanent storage module CMC600, if connected).
Use all code types for teaching (except for pharmacode)	Codes of all types except for PHARMACODE can be taught in. The settings of the <a href="#">Code configuration</a> group will not be considered for teach-in.
Use the set code types from code configuration for teaching	Only codes of the active code types can be taught in (see <a href="#">chapter 2.2.3 Code configuration, page 13</a> ).
Use only pharmacode type for teaching	Only pharmacodes can be taught in.



#### 2.2.4.4 Filter/Sorter for output formatting

**Filter/Sorter for output format #1** Code contents for output format #1 are filtered and/or sorted via the parameters of the [Filter/Sorter for output format #1](#) group.

Parameter	Function
Filter	Filter code contents according to various criteria.  Define filter criteria.
Sorter	Sort code contents according to various criteria.  Define sorter criteria.

The filter and sorter can be arranged in any order and number by drag & drop. To arrange them parallel to each other, they must be moved between the margin and the available filter/sorter. To copy a filter/sorter by drag & drop, press the Ctrl button. To delete a filter/sorter, drag it into the recycle bin (mouse pointer must be above recycle bin).

**Filter/sorter for output format #2** Code contents for output format #2 are filtered and/or sorted via the parameters of the *Filter/sorter for output format #2* group.

Parameter	Function
Filter	Filter code contents according to various criteria.  Define filter criteria.
Sorter	Sort code contents according to various criteria.  Define sorter criteria.

The filter and sorter can be arranged in any order and number by drag & drop. To arrange them parallel to each other, they must be moved between the margin and the available filter/sorter. To copy a filter/sorter by drag & drop, press the Ctrl button. To delete a filter/sorter, drag it into the recycle bin (mouse pointer must be above recycle bin).

**2.2.4.5 Output format**

**Output format #1** The reading results (decoded codes) are output by definable data interfaces. For this, two different output formats (telegrams) can be defined. The format can also depend on conditions.

The first format of the reading results is defined via the parameters of the *Output format #1* group.

Parameter	Function
Output format #1	Enter output format of the reading results. <input type="checkbox"/> Open input field. <input type="checkbox"/> Close input field. <input checked="" type="checkbox"/> Select condition. Right mouse click: Insert new condition, data field or special character. Click on the bottom row of the data field: Select attribute characteristics.
Maximized	Activate/deactivate view with open input fields.



The created output format can be marked and copied into a text editor for saving. To copy it back, right-click on the *Output format #1* window and select "PASTE FROM EXTERN...".

**Output format #2** The reading results (decoded codes) are output by definable data interfaces. For this, two different output formats (telegrams) can be defined. The format can also depend on conditions.

The second format of the reading results is defined via the parameters of the *Output format #2* group.

Parameter	Function
Output format #2	Enter output format of the reading results. <input type="checkbox"/> Open input field. <input type="checkbox"/> Close input field. <input checked="" type="checkbox"/> Select condition. Right mouse click: Insert new condition, data field or special character. Click on the bottom row of the data field: Select attribute characteristics.
Maximized	Activate/deactivate view with open input fields.



The created output format can be marked and copied into a text editor for saving. To copy it back, right-click on the *Output format #2* window and select "PASTE FROM EXTERN...".

**Heartbeat format** If no reading results are being output, a regular scanner signal, a so-called heartbeat, can be output.

The format of the heartbeat is defined via the parameters of the *Heartbeat format* group.

Parameter	Function
Heartbeat format	Enter output format of the heartbeat. Right mouse click: Insert special character.



The created output format can be marked and copied into a text editor for saving. To copy it back, right-click on the *Heartbeat format* window and select "PASTE FROM EXTERN...".

**Example** Conditions for the following example:

- Output of barcodes of code type Code 128 that contain the character sequence "45".
- Condition is met: output of "MATCHCODE" and the code content in the output string.
- Condition is not met: output of "NOMATCH" in the output string.
- No valid code could be read: output of "NoRead" in the output string.

To achieve such a result, the following OUTPUT FORMAT and an appropriate CONDITION (see [chapter 2.2.4.2 Evaluation conditions, page 23](#)) must be created.

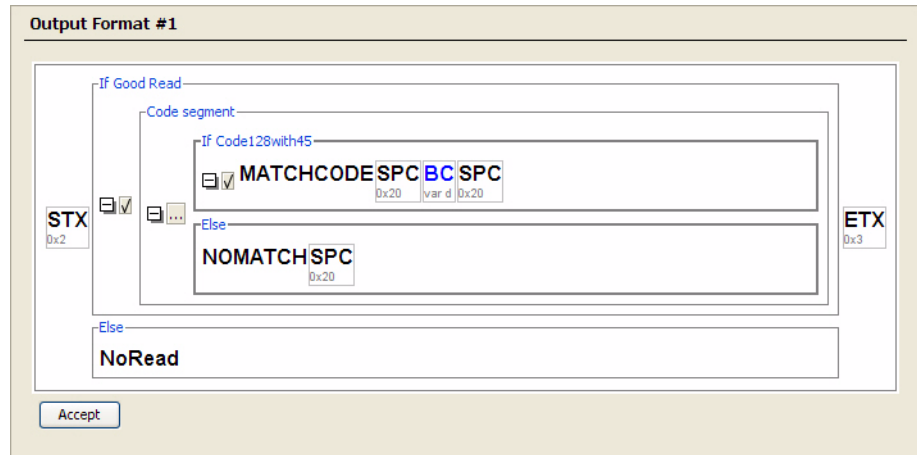

### 2.2.5 Network / Interface / IOs

**Network options** The scanner is identified in the network via the parameters of the [Network options](#) group.

Parameter	Function
Network assistant	Call up dialog in which the most important parameters of the following pages are grouped: <ul style="list-style-type: none"> <li>• <a href="#">chapter 2.2.5.3 CAN, page 35</a></li> <li>• <a href="#">chapter 2.2.5.2 Ethernet, page 33</a></li> <li>• <a href="#">chapter 2.2.1.1 Object trigger control, page 9</a></li> </ul>
Device ID	Enter CAN Bus address of the scanner.
Device name	Enter device name. This name is displayed at the top of the project tree.

**Master / Slave** The master / slave connection of the scanner in the SICK CAN sensor network is defined via the parameters of the [Master / Slave](#) group.

[Master / Slave](#) means that a group of scanners read the barcodes of the same object. The common reading result is transmitted to the host. Viewed from the host side, the master / slave group works like a single scanner.

Parameter	Function
Function	Select scanner's function in a master / slave connection.
Assign to	Select connection between master and slave.
Output time	Select output time of reading results.
Slave list	Enter device numbers of slave scanners. The "SLAVE" function must be selected for the slave scanner.

**Monitoring** The scanners which are to be monitored by this scanner can be set via the parameters of the *Monitoring* group.

Parameter	Function
Assign to	Select connection for monitoring
Monitored devices	Enter the device numbers of the scanners which are to be monitored by this scanner.
Maximum starting time of monitored devices	Enter time during which a missing signal of a monitored device will be ignored.

**Multiplexer** The multiplexer network is configured via the parameters of the *Multiplexer* group.

Each scanner in the CAN network can emulate the functions of the multiplexer. Therefore, a cooperation of scanners can be established with just one interface to the host without the need of an additional multiplexer device. A multiplexer can operate up to 31 slave scanners. The multiplexer sends all reading results or data strings received by a slave scanner to the host. The device number of the scanner is added to the reading result. Therefore, the host can distinguish between the different data sources. Furthermore, the host has the possibility to send addressed data strings to the multiplexer which are then transferred to the corresponding scanner in the network.

Parameter	Function
Assign to	Select connection for multiplexing.
Server list	Enter device numbers of scanners which participate in the multiplexing.

### 2.2.5.1 Serial

**Serial host interface** The serial host interface is configured with the parameters of the *Serial host interface* group.

The serial host interface provides the reading result for further processing by the host computer.

Parameter	Function
Protocol / Output format	Select the format for the output of the reading result via the serial host interface.
Multiplexer output	Activate/deactivate data output via multiplexer.
Baudrate	Select speed of serial host interface.
Stopbits	Select number of stopbits.
Databits / Parity	Select number of databits and parity.
Hardware	Select the type of serial host interface.
Activate heartbeats	Activate the output of a regular heartbeat.
Heartbeat interval	Enter time between two heartbeats.
Restart interval on sending	Restart interval after the output of a reading result.
Gateway	Activate PROFIBUS DP interface or DeviceNet respectively.



**Serial auxiliary interface** The aux interface is configured with the parameters of the *Serial auxiliary interface* group.

Parameter	Function
Protocol / Output format	Define the output of the auxiliary interface.
Activate heartbeats	Activate the output of a regular heartbeat.
Heartbeat interval	Enter time between two heartbeats.
Restart interval on sending	Restart interval after the output of a reading result.
Gateway	Activate PROFIBUS DP interface or DeviceNet respectively.

**PROFIBUS DP Gateway** The PROFIBUS DP interface is configured with the parameters of the *PROFIBUS DP Gateway* group.

Parameter	Function
Use device ID as profibus address	Activate/deactivate the scanner's device ID as profibus address.
Device ID	The device ID of the scanner is displayed.
Operating mode	Select the profibus protocol.

**DeviceNet Gateway** The DeviceNet interface is configured with the parameters of the *DeviceNet Gateway* group.

Parameter	Function
Use device ID as DeviceNet address	Activate/deactivate the scanner's device ID as DeviceNet address.
Address	Enter the device address in DeviceNet.
Operating mode	Select the DeviceNet protocol.
Baudrate	Select speed of DeviceNet interface.
Length of input-data	Enter the length of the input data.
Length of output-data	Enter the length of the output data.

### 2.2.5.2 Ethernet

The Ethernet interface provides the reading result for further processing by the host computer.

**General** The network settings of the scanner are set via the parameter of the *General* group. These settings must be defined by the network administrator.



The scanner has to be restarted after modification of one of this group parameters.

Parameter	Function
IP address	Enter IP address of scanner.
Subnet mask	Enter subnet mask of scanner.
Default gateway	Enter default gateway of scanner.
Speed	Select network speed.
MAC address	Enter MAC address of scanner.

**Ethernet host port** The Ethernet host interface is configured with the parameters of the *Ethernet host port* group.

The Ethernet host interface provides the reading result for further processing via the host computer in parallel to the serial host interface.

Parameter	Function
Protocol / Output format	Select the format for the output of the reading result via the Ethernet host interface.
Multiplexer output	Activate/deactivate data output via multiplexer.
Server / Client	Select whether the scanner works as a server or a client.
IP port	Enter the IP port for the exchange of network data.
Server address	Enter server address.
Activate heartbeats	Activate the output of a regular heartbeat.
Heartbeat interval	Enter time between two heartbeats.
Restart interval on sending	Activate a new start of the interval after the output of a reading result.

**Ethernet aux port** The Ethernet aux interface is configured with the parameters of the *Ethernet aux port* group. The Ethernet aux interface provides the serial aux interface function in parallel.

Parameter	Function
Server / Client	Select whether the scanner works as a server or a client.
IP port	Enter the IP port for the exchange of network data.

**Ethernet RDT400 port** The RDT400 interface is configured with the parameters of the *Ethernet RDT400 port* group.

Parameter	Function
Server / Client	Activate/deactivate the port's function. The device works as client if the function is activated.
RDT-ID	Enter the knot ID for the device in the RDT400 network.
IP port	Enter the IP port for the exchange of network data.
Server address	Enter the address of the RDT400 server to which the bar code scanner sends the data.

**WEBSERVER** The webserver function of a scanner is activated/deactivated via the parameters of the *Webserver* group.

### 2.2.5.3 CAN

**CAN** The data interface CAN is configured via the parameters of the [CAN](#) group.

Parameter	Function
Mode	Select the type of CAN network.
Use device ID as knot ID	Activate/deactivate the use of the scanner device ID as the ID of the knot in the CAN network. For distribution of the device ID see <a href="#">chapter 2.1 Quickstart, page 7</a> .
Device ID	Scanner device ID in the CAN network is indicated.
Baudrate	Select network speed.
Output format	Select output format via which the reading result is to be output via the CAN network.

### 2.2.5.4 Digital inputs

**Sensor 1** The first digital input is configured via the parameters of the [Sensor 1](#) group.

Parameter	Function
Control	Select the type of control.
Sensitivity	Select sensitivity of sensor.
Logic	Select logic of input 1.
Debouncing	Enter detection time for signal at input 1. If applicable, select unit.

**Sensor 2** The second digital input is configured via the parameters of the [Sensor 2](#) group.

**Important** This connection is only available on the bar code scanner with a cable and connector (standard version) and for the Ethernet version via the CDB620 connection module in combination with the parameter memory module CMC600

Parameter	Function
Control	Select the type of control.
Sensitivity	Select sensitivity of sensor.
Logic	Select logic of input 2.
Debouncing	Enter detection time for signal at input 2. If applicable, select unit.

**External Input 1** The first digital external input of the CDB620 connection module in connection with the CMC600 parameter memory module or of the CDF600 connection module is configured via the parameters of the [External Input 1](#) group.

Parameter	Funktion
Control	Select the type of control.
Sensitivity	Select sensitivity of sensor.
Logic	Select logic of the external input 1.
Debouncing	Enter detection time for signal at the external input 1. If applicable, select unit.

**External Input 2** The second digital external input of the CDB620 connection module in connection with the CMC600 parameter memory module or of the CDF600 connection module is configured via the parameters of the [External Input 2](#) group.

Parameter	Funktion
Control	Select the type of control.
Sensitivity	Select sensitivity of sensor.
Logic	Select logic of the external input 2.
Debouncing	Enter detection time for signal at the external input 2. If applicable, select unit.

### 2.2.5.5 RDT400

**RDT400 protocol** The parameters of the [RDT400 protocol](#) group are used to assign the evaluation conditions of the code types.

Parameter	Function
Condition for code type 1	Select evaluation condition which should be applied for code type 1 (see <a href="#">chapter 2.2.4.2 Evaluation conditions, page 23</a> ).
Condition for code type 2	Select evaluation condition which should be applied for code type 2 (see <a href="#">chapter 2.2.4.2 Evaluation conditions, page 23</a> ).
Condition for code type 3	Select evaluation condition which should be applied for code type 3 (see <a href="#">chapter 2.2.4.2 Evaluation conditions, page 23</a> ).

### 2.2.5.6 Digital outputs

For certain system conditions (e.g. decoding "No Read" failed), independent switching signals which can be used for displaying the system condition can be output at the digital outputs.

**Output 1** The fieldbus interface is configured with the parameters of the [Output 1](#) group.

**Important** This connection is only available on the bar code scanner with a cable connector (standard version) and for the Ethernet version via the CDB620 connection module in combination with the parameter memory module CMC600.

Parameter	Function
Output 1	Select event that is to trigger a signal at output 1.
Logic	Select logic level of the selected output 1.
Control	Select type of control.
Duration	Enter signal duration. If applicable, select unit.

**Output 2** The digital output 2 is configured with the parameters of the *Output 2* group.

**Important** This connection is only available on the bar code scanner with a cable connector (standard version) and for the Ethernet version via the CDB620 connection module in combination with the parameter memory module CMC600.

Parameter	Function
Output 2	Select condition that is to trigger a signal at output 2.
Logic	Select logic level of the selected output 2.
Control	Select type of control.
Duration	Enter signal duration. If applicable, select unit.

**External output 1** Use the parameters of the *External output 1* group to configure the digital external output 1 of the CDB620 connection module in connection with the CMC600 parameter memory module or of the connection module.

Parameter	Function
Output 1	Select event that is to trigger a signal at the external output 1.
Logic	Select logic level of the selected external output 1.
Control	Select type of control.
Duration	Enter signal duration. If applicable, select unit.

**External output 2** Use the parameters of the *External output 2* group to configure the digital external output 2 of the CDB620 connection module in connection with the CMC600 parameter memory module or of the connection module.

Parameter	Function
Output 2	Select event that is to trigger a signal at the external output 2.
Logic	Select logic level of the selected external output 2.
Control	Select type of control.
Duration	Enter signal duration. If applicable, select unit.

**Beeper** The beeper is configured with the parameters of the *Beeper* group.

Parameter	Function
Beeper	Select condition which is to trigger the beeper.
Volume	Select the beeper volume.

### 2.2.5.7 Fieldbus CDF600

**CDF600 Profibus** The profibus interface is configured with the parameters of the *CDF600 Profibus* group. The fieldbus interface provides the reading result for further processing.

Parameter	Function
Bus address	The address of the device is displayed.
Communication mode	Select the operating mode for the fieldbus interface.
Protocol / Output format	Select the format for the output of the reading result via the serial fieldbus interface.
Usage output Bit0	Select the function of output bit 0.
Usage output Bit1	Select the function of output bit 1.
Usage input Bit0	Select the function of input bit 0.
Usage input Bit1	Select the function of input bit 1.

## 2.3 Service

### 2.3.1 Operating data

**Device information** The identification data of the scanner is indicated via the parameters of the *Device information* group. This data is important for service work.

Parameter	Function
Manufacturer	The manufacturer of the scanner is indicated.
Order number	The order number of the scanner is indicated.
Serial number	The serial number of the scanner is indicated.
Software version	The version of the installed firmware is indicated.
Device type	The device type of the scanner is indicated.

**Operating data** Information on the previous operation of the scanner is indicated via the parameters of the *Operating data* group.

Parameter	Function
Turning on counter	Indicates how often the scanner has been activated.
Operating hours	Indicates the total number of scanner operating hours.
Daily operating hours	Indicates the scanner operating time since the last activation.

**Service information** Information on the service and maintenance of the scanner is indicated via the parameters of the *Service information* group.

Parameter	Function
Last user	Last logged-in user is indicated.
Last parameterisation	The date of the last parameterisation is indicated.
At	The time of the last parameterisation is indicated.
Last maintenance	Enter date of the last maintenance
Next maintenance	Enter date of the next maintenance.

### 2.3.2 System status















**System information** System messages are indicated via the parameters of the *System information* group.

Parameter	Function
Type	Type of message is indicated.
First occurrence	Time of first occurrence is indicated.
Latest occurrence	Time of latest occurrence is indicated.
Number	Number of message is indicated.
Description	Text of message is indicated.
Info	Further information concerning the message is indicated.
Status	Status of message is indicated.
Counter	The number of message occurrences is indicated.

## 2.4 Analysis

### 2.4.1 Event monitor

**Event monitor** Signals, inputs and outputs can be monitored via the diagrams of the *Event monitor* group.

Symbol	Function
	Select signal that has to be monitored.
	Open a previously recorded monitoring diagram.
	Save the current monitoring diagram.
	Measure distances within the diagram.
	Start monitoring.
	Interrupt monitoring.
	Stop monitoring.
	Record monitoring.
	Enlarge diagram.
	Set zoom of the diagram to 100 %.
	Scale down diagram.
	Indicate time axis in diagram.
	Indicate increment axis in diagram.
	Activate/deactivate matrix in diagram.
	Indicate values in diagram.

