

Technical Data for USB Type LED Tower Light

Can be connected to the USB port of your PC without any additional power supply

- The LED tower light that is fully controllable by the PC application program of a PC via an USB port connection
- The USB communication cable is comprise of VCC, D-, D +, GND, and Shield
- Uses 2 DC 5V/500mA rated Personal Computer (PC) USB for its power
- Available on hosts that support USB 1.1 or higher
- Provides MS Runtime libraries for developers to utilize on various PC applications
- Built-in clear melody, alarm sound, the type of sound can be chosen when ordered
- Supported OS(32bit 64bit) : Windows XP, Windows 7, Windows 10
- Supported Program : VC++, VB, Delphi(32bit only), C#(64bit only)

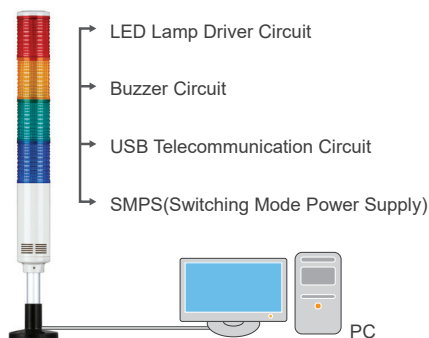

- Qlight's USB Tower Light is a LED tower lamp connected to a USB interface and controlled by a PC program. These products work on hosts that support USB 1.1 or higher and allow up to 4 USB Tower Light connections per PC
 - Supports Low speed (1.5Mbps) and Full speed (12Mbps) communication
 - Provides MS Runtime libraries for developers(VC ++, VB, Delphi) to utilize in various PC applications. A sample program (VC ++) is available for testing purposes. The product uses device drivers in the PC for built-in HID (Human Interface Devices). Therefore, the operating system (OS) does not need a separate driver to control and to communicate with the LED Tower Light through the PC application
- Native support for 32bit OS, and supports 64bit in Windows XP, Win7. For other OS, please contact us(32bit 64bit)

※ Image to the left shows the Tower Light Connections.

1. Basic USB Information

USB is an abbreviation for Universal Serial Bus, a PC peripheral bus standard developed to satisfy the industries growing need in the mid 1990s for a new interconnection between computers and electronic devices. Developed by companies such as Intel, Microsoft, Compaq, IBM, NEC, Nortel, DEC etc. the USB can connect up to 127 devices without reboot or setup for new peripherals. Data transfer speed have been improving rapidly.

Communication	DEVICE CLASS CODE	INTERFACE CLASS CODE
Audio Interface	0x00	0x01
Communication Device	0x02	-
HID	0x00	0x00
HUB	0x09	0x09
Storage	0x00	0x08
Monitor	Same as HID	Same as HID
Print	-	0x07

※ HID(Human Interface Devices)?

USB can be applied to various devices and can be classified by its use case. Among them is the USB classification called the Human Interface Device (HID). These devices can be used to control the PC. A typical HID device includes a mouse, keyboard, joystick, etc. The data from the devices is sent to the host(PC) by a "interrupt" type IN-endpoint format.

2. Connection

The process of connecting and detecting the device to the USB port is called "the initial determination". After "the initial determination" is made, the host PC requests the device's specific role and the function is then specified by the Descriptor. At that moment the device and the PC periodically exchanges requests, and the descriptor. This process is called "Enumeration". After the finishing the "enumeration" process the PC detects the device and registers it as a USB Device. When the registration is completed, the USB Device exchanges data and perform its designated function.

The process how the USB Device is connected to the PC

1. When you connect a USB Device to the PC, Device is powered on.
2. Normally the D+, D- of the PC is on low signal with both D+ and D- having pull down resistors of 15KΩ.
3. A full speed USB Device has a pull-up resistor of 1.5KΩ hung on D+, Low speed devices on the other hand have a pull-up resistor of 1.5KΩ on the D-.
4. Therefore, the PC usually has a low signal on the data line but when the USB device is connected the PC it detects the high signal of the data line and notifies the host of the USB device connection.

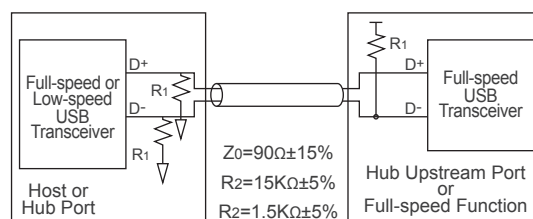
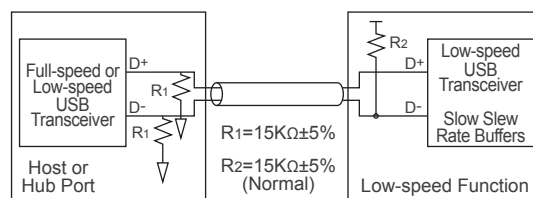

Technical Data for USB Type LED Tower Light

3. Communication data format of the USB product

Developers can use the programming format below to control the LED USB Tower light via PC. For detailed programming information, please see the reference code that is provided separately.

PC to USB Tower Light				
No.	Type	ABB	Descript	Size(Bytes)
1	Device Information	VID	VENDOR ID : 0x04D8(Provided by IC manufacturer)	2
2		PID	PRODUCT ID : 0xE73C(QLIGHT ID)	2
3		INDEX	1. Maximum of 4 USB tower lights can be installed per PC. 2. Field value helps to distinguish each USB tower light. 3. Reference - USB0 : 0x4970/ USB1 : 0x4971/ USB2 : 0x4972/ usb3 : 0x4973 4. Assign 0-3 for convenient use in IBM PC environment.	2
1	Data	Write	1. Send 'W=0x57' which means transferring the data from PC to USB.	1
2		Sound Group	1. Field for sound pattern designation. 0 : WS/ 1 : WP/ 2 : WM/ 3 : WA/ 4 : WB/ 5 : BZ/ 6 : WM(8)/ 7 : WA(8) 2. Total 8 groups are provided and each group has channel 1 to 5.	1
3		R LAMP	1. Field for controlling Red lamp. 2. Reference - 0 : LAMP OFF/ 1 : LAMP BLINK(ON/OFF)/ 2 : LAMP ON/ Else : Don't care	1
4		A LAMP	1. Field for controlling Amber lamp. 2. Reference - 0 : LAMP OFF/ 1 : LAMP BLINK(ON/OFF)/ 2 : LAMP ON/ Else : Don't care	1
5		G LAMP	1. Field for controlling Green lamp. 2. Reference - 0 : LAMP OFF/ 1 : LAMP BLINK(ON/OFF)/ 2 : LAMP ON/ Else : Don't care	1
6		B LAMP	1. Field for controlling Blue lamp. 2. Reference - 0 : LAMP OFF/ 1 : LAMP BLINK(ON/OFF)/ 2 : LAMP ON/ Else : Don't care	1
7		W LAMP	1. Field for controlling White lamp. 2. Reference - 0 : LAMP OFF/ 1 : LAMP BLINK(ON/OFF)/ 2 : LAMP ON/ Else : Don't care	1

4. Block Diagram

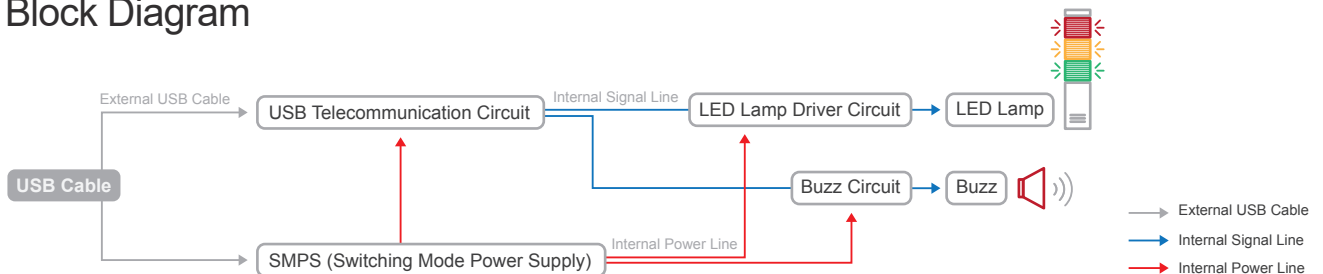

5. Specifications

Category	Specifications	Category	Specifications
Tower light	<ul style="list-style-type: none"> Layer : 1-5 Voltage : DC12V Current : 0.300A Color : <ul style="list-style-type: none"> R-Red A-Amber G-Green B-Blue W-White 	Cable	<ol style="list-style-type: none"> VCC (Red) D- (White) D+ (Green) GND (Black) Shield
Speaker	<ul style="list-style-type: none"> Rated : 1W Volume : Max 85dB at 1m 	Buzzer	<ul style="list-style-type: none"> Voltage : DC12V Current : 20mA Volume : Max 90dB at 1m
USB standard	<ul style="list-style-type: none"> Available on hosts that support USB 1.1 or higher DC5V/500mA rated (uses 2 USB port) 	Input voltage	<ul style="list-style-type: none"> USB DC 5V×2PORT(Built-in 5V To 12V converter)

Technical Data for USB Type LED Tower Light

6. USB Cable

1. The power consumption of a USB Tower light(3 layers type) is only about 2.5W.
2. The USB specification is 5VDC/(300mA/500mA) per PC port which equals approximately 1.5W. Thus, using two ports will supply the proper power to the product.
3. It is possible to use multiple colors at the same time by using the USB power supply, but using one lamp and one alarm sound at a time is recommended.
4. There are two types of USB connections as shown in the image below; a standard USB connector and a USB power connector with a power line connected in parallel.

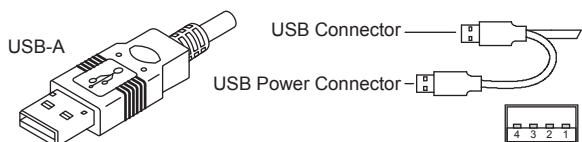

Pin	Name	WIRE Color	Description
1	VCC	RED	+5V
2	D-	WHITE	Data-
3	D+	GREEN	Data+
4	GND	BLACK	Ground

7. Use of the USB device

1. Connect the USB tower light to the PC as shown in the illustration above.
2. Download the test program from the provided CD or from our homepage.
3. The downloaded sample program will be saved as “USB Test Program.zip”. When you unzip the file, there will be a file with the names below.

QLight_Lamptest_USB.exe

Test program

QUvc_dll.dll

Required library for test program

※ When developing the program, please download and refer to the file “manual and library”(sample programs and manuals for developers).

4. When you run the “QLight lamptest_usb.exe”file, a test programs will show up as above. Products sound options are classified as WS w/P w/A w/M / BZ . The product will only play the sound option selected when the order was placed.

Article	Detailed specification
1 Lamp Control	- ON: Lamp turns on when the button is clicked - ON/OFF: Lamp flashes when the button is clicked - OFF: Lamp turns off when the button is clicked
2 Sound Select	- 1ch-5ch: Has 5 sounds per model, turns on the chosen sound - Click “Sound off” button to turn off the sound
3 Model Select	- WS : 5 warning sounds(mono) - WP : 5 special warning sounds(mono) - WM(1) : 5 Melodies(mono) - WA(1) : 5 alarms(mono) - WB : Software Buzzer 5 sounds(speaker type) - Buzzer : 5 Buzzer sounds
4 Index	- You can connect up to a Maximum of 4 USB Tower lights per PC - Must be controlled by selecting Index0 - Index3 for controlling the USB tower light. The default is set to Index0

STDEL-USB

USB LED Steady/ Flashing Tower Light & Electric Horn Combination



USB controllable high signal sound

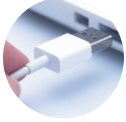

STDEL-USB

STDEL-USB Ø80mm USB Steady/ Flashing Tower Light & Electric Combination

Model number	Layer	Certificate	Color
STDEL-USB-WS	5 Warning sounds	1 layer	1 layer : ●R
STDEL-USB-WM	5 Melodies	2 layers	2 layers : ●R ●G
STDEL-USB-WA	5 Alarms	3 layers	3 layers : ●R ●A ●G
		4 layers	4 layers : ●R ●A ●G ●B
		5 layers	5 layers : ●R ●A ●G ●B ●W



Technical Diagram

(Units : mm)

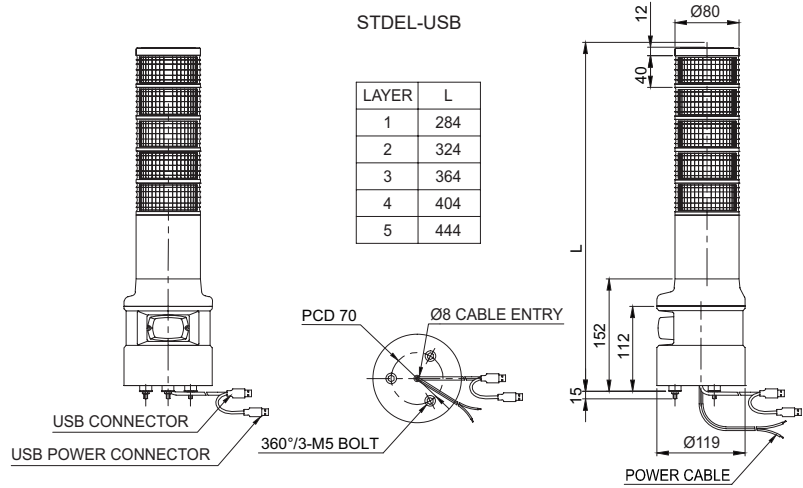

Wiring Instructions

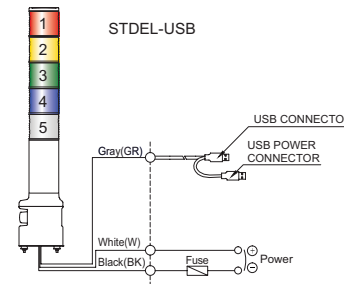

Wiring Instructions

- External power line : UL1015 AWG18(0.75sq)×2C 400mm
- USB Cable : Connect both USB connector and USB power connector to PC

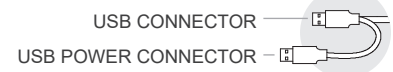

Customization

- Customized color arrangement available
- 70mm lens height(Standard : 40mm)



Ordering Specification

STDEL-USB-WS	-	3	-	24	-	RAG
[Model number]		[Layer]		[Voltage]		[Color]
<ul style="list-style-type: none"> STDEL-USB-WS STDEL-USB-WM STDEL-USB-WA 		<ul style="list-style-type: none"> 1-1 layer 2-2 layers 3-3 layers 4-4 layers 5-5 layers 		<ul style="list-style-type: none"> 12-DC12V 24-DC24V 110-AC110V 220-AC220V 		<ul style="list-style-type: none"> ● R-Red ● A-Amber ● G-Green ● B-Blue ● W-White