

### Clear and Strong Signal Light Emitted through the Colored Diffusion Lens



#### Common Specifications(QTG50/ QTG60/ QTG70)

- Modular LED steady/flashing type signal tower lights
- Excellent visibility from a distance with the use of a special color diffusing lens
- Can select from size selections of Ø50mm, Ø60mm, and Ø70mm to fit your sophisticated application needs
- The addition of modules and change in color arrangement can be achieved without the use of tools by using the Lock-type structure
- QTGA type offers a nifty integrated lens and cover for a simple aesthetically pleasing product
- A variety of mounting bracket selections for the pole mount type to fit your location and mounting needs
- Buzzer sound output : Sound volume of Max 85dB at 1m
- Available in 2 customized options; sounds buzzer type and high volume(100dB) buzzer type
- Pre-wired is standard. Can customize the product with the M12 connector if requested
- Can be used with NPN open collector transistor driven input, which allows direct connection to a PLC
- Flashing rate : 60-80 flashes/min
- Materials : Lens-PC, Housing-ABS, Pole-Al
- Ambient operating temperature : -30°C to +50°C
- Protection rating : Standard type-IP65, Built-in buzzer type-IP54
- Certificates : CE Compliant, UL Listed
- Compliant with RoHS directive



#### • Each modular color lens can be added without additional tools

QTG model uses a special contact structure for stable operation, the lens modules lock into place by rotating the modular structures together. This allows for easy changes to the color arrangement without any tools. Additional modules can be added.

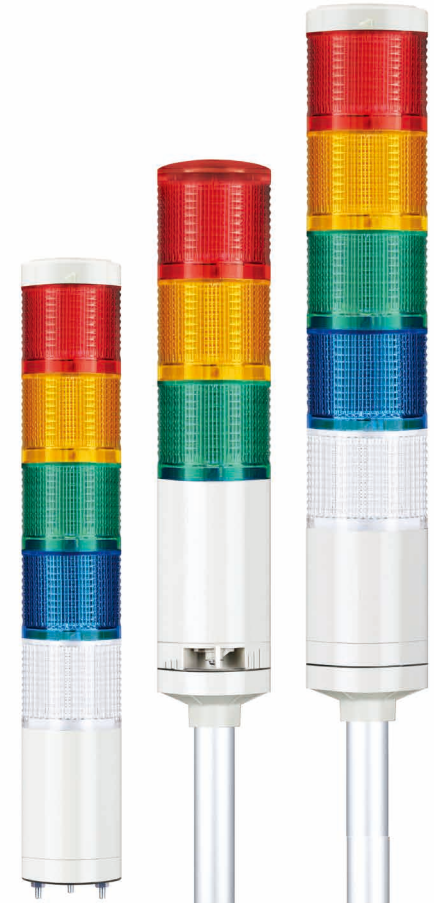

#### • Buzzer volume is adjusted via the volume control lever

QTG type volume can be adjusted for each specific working condition with the equipped buzzer volume control lever at the bottom of the product.(-BZ type)

- 1 High volume buzzer (100dB) option can be fitted to the top of the product. (Customization)**  
 High volume 100dB volume buzzer module fastened to the top of the product provides 360 degree buzzer signal output which cannot be achieved with the single directional buzzer.(Buzzer volume cannot be adjusted)
- 2 Integrated cover and lens model (QTGA50/ QTGA60/ QTGA70)**  
 QTGA50/ QTGA60/ QTGA70 The sleek lens cover model is made of one piece for a simple unified look.
- 3 Cable end M12 connector attached type (Customization)**  
 Pre-wired is standard. Can customize the product with the M12 connector if requested.
- 4 Can select from a variety of mounting brackets option to fit your application needs and build environment**  
 There are a variety of mounting brackets options available depending on cost and installation requirements.

# QTG70ML

## Ø70mm LED Steady/Flashing Tower Lights

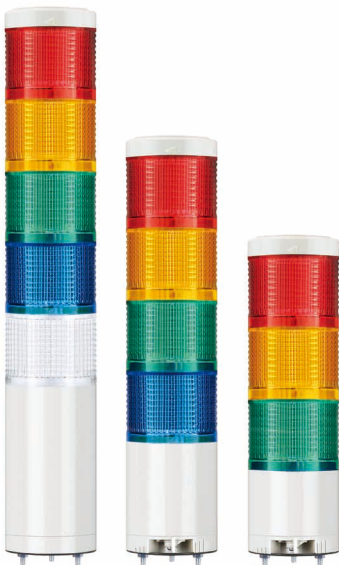
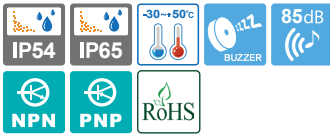

QTG70ML series

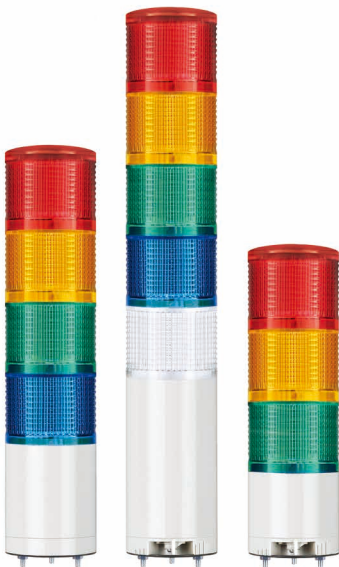

QTGA70ML series

• Customization



• Customized cable end M12 connector attached type available.

### QTG70ML Ø70mm Direct Mount, LED Steady/Flashing Type

Model number	Layer	Voltage	Current	Certificates	Weight	Color
QTG70ML Steady	1	AC/DC12V	0.100A	  DC24V only	0.42kg	• R-Red
QTG70ML-BZ Steady /w built-in buzzer		AC/DC24V	0.070A		0.42kg	
QTG70MLF Steady/Flashing	2	AC/DC12V	0.200A		0.56kg	• R-Red • G-Green
QTG70MLF-BZ Steady/Flashing /w built-in buzzer		AC/DC24V	0.140A		0.66kg	
QTGA70ML Steady	3	AC/DC12V	0.300A		0.77kg	• R-Red • A-Amber • G-Green
QTGA70ML-BZ Steady /w built-in buzzer		AC/DC24V	0.210A		0.77kg	
QTGA70MLF Steady/Flashing	4	AC/DC12V	0.400A		0.92kg	• R-Red • A-Amber • G-Green • B-Blue
QTGA70MLF-BZ Steady/Flashing /w built-in buzzer		AC/DC24V	0.280A		0.92kg	
QTGA70MLF Steady/Flashing	5	AC/DC12V	0.500A		1.07kg	• R-Red • A-Amber • G-Green • B-Blue • W-White
QTGA70MLF-BZ Steady/Flashing /w built-in buzzer		AC/DC24V	0.350A		1.07kg	
		AC110V-220V	Max. 0.055A		0.52kg	
		AC110V-220V	Max. 0.075A		0.66kg	
		AC110V-220V	Max. 0.095A		0.87kg	
		AC110V-220V	Max. 0.115A		1.02kg	
		AC110V-220V	Max. 0.135A		1.17kg	

\* AC type model has a free-voltage range of 100V-240V.

#### Signal/ Audible Line Current(per each layer)

Voltage	AC/DC12V	AC/DC24V	AC110V-220V
Signal line current	0.100A	0.070A	Max 0.055A
Audible line current	0.020A	0.050A	Max 0.045A

#### Wiring Instructions

- External power line : UL1015 AWG18(0.75sq)×2C 400mm
  - External signal line : UL1007 AWG22(0.3sq) 400mm
  - LED tower light can be wiring with external contact and transistor
- \* Please refer to page 88-89 for detailed wiring instructions.

#### Customization

- High buzzer module equipped on top(Lens should be within 4 layers)
- Cable end M12 connector attached type
- 2 buzzer sound types : Both prolonged (beep, beep) and staccato (beep, beep, beep) buzzer output available
- Wall mount bracket options : Bracket structure allows for threading through the bracket hole or into the wall mount



#### Ordering Specification

<b>QTG70ML</b>	-	<b>3</b>	-	<b>24</b>	-	<b>RAG</b>
[Model number]		[Layer]		[Voltage]		[Color]
<ul style="list-style-type: none"> <li>• QTG70ML</li> <li>• QTG70ML-BZ</li> <li>• QTG70MLF</li> <li>• QTG70MLF-BZ</li> <li>• QTGA70ML</li> <li>• QTGA70ML-BZ</li> <li>• QTGA70MLF</li> <li>• QTGA70MLF-BZ</li> </ul>		<ul style="list-style-type: none"> <li>• 1-1Layer</li> <li>• 2-2Layers</li> <li>• 3-3Layers</li> <li>• 4-4Layers</li> <li>• 5-5Layers</li> </ul>		<ul style="list-style-type: none"> <li>• 12-DC12V</li> <li>• 24-DC24V</li> <li>• 110/220</li> <li>-AC110V-220V</li> </ul>		<ul style="list-style-type: none"> <li>• R-Red</li> <li>• A-Amber</li> <li>• G-Green</li> <li>• B-Blue</li> <li>• W-White</li> </ul>

# QTG series

## LED Steady/Flashing Tower Lights



### Technical Diagram

(Units : mm)

QTG50ML : DC  
QTG50MLF : DC  
QTG50ML-BZ : DC

QTG50ML : AC  
QTG50MLF-BZ : DC

QTG50MLF : AC  
QTG50ML-BZ : AC  
QTG50MLF-BZ : AC

QTG50L : DC  
QTG50LF : DC  
QTG50L-BZ : DC

QTG50L : AC  
QTG50LF-BZ : DC

QTG50LF : AC  
QTG50L-BZ : AC  
QTG50LF-BZ : AC

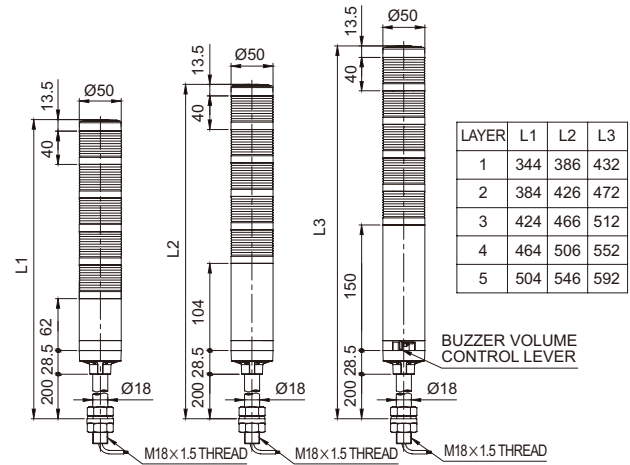
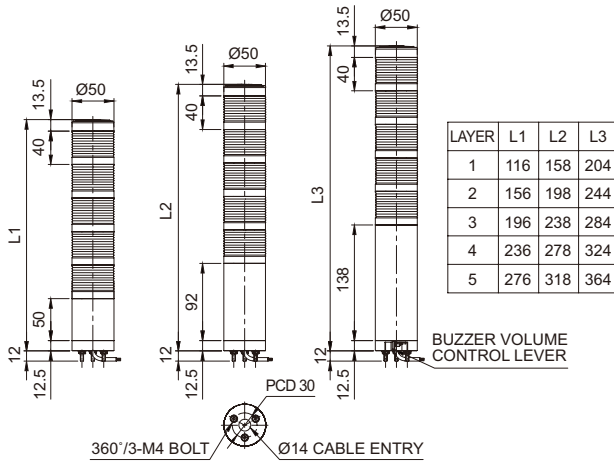

QTG60ML : DC  
QTG60MLF : DC  
QTG60ML-BZ : DC

QTG60ML : AC  
QTG60MLF-BZ : DC

QTG60MLF : AC  
QTG60ML-BZ : AC  
QTG60MLF-BZ : AC

QTG60L : DC  
QTG60LF : DC  
QTG60L-BZ : DC

QTG60L : AC  
QTG60LF-BZ : DC

QTG60LF : AC  
QTG60L-BZ : AC  
QTG60LF-BZ : AC

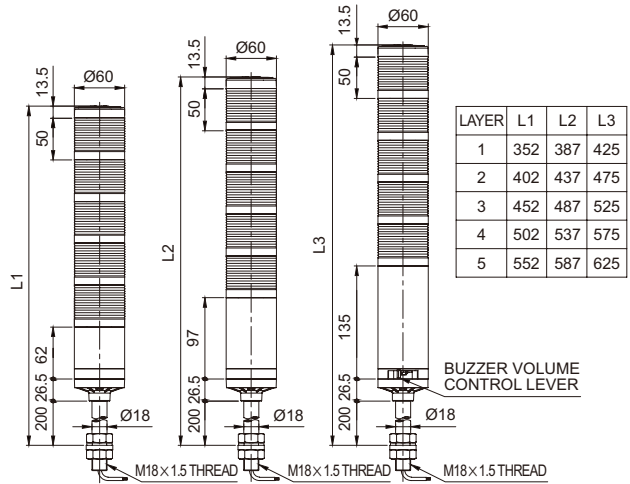
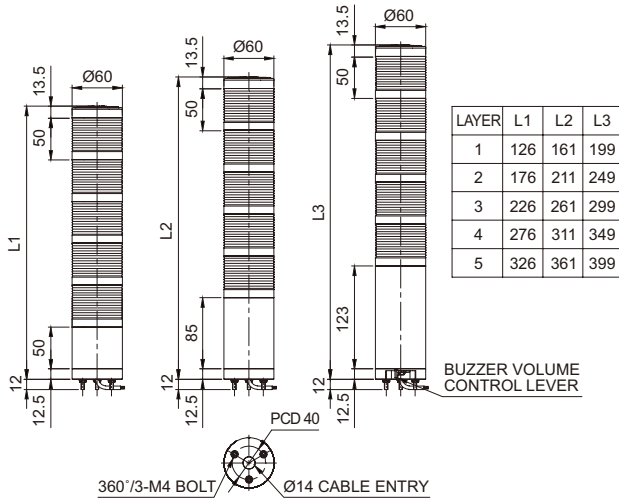

QTG70ML : DC  
QTG70MLF : DC  
QTG70ML-BZ : DC

QTG70ML : AC  
QTG70MLF : AC  
QTG70MLF-BZ : AC  
QTG70MLF-BZ : DC

QTG70MLF-BZ : AC

QTG70L : DC  
QTG70LF : DC  
QTG70L-BZ : DC

QTG70L : AC  
QTG70LF : AC  
QTG70L-BZ : AC  
QTG70LF-BZ : DC

QTG70LF-BZ : AC

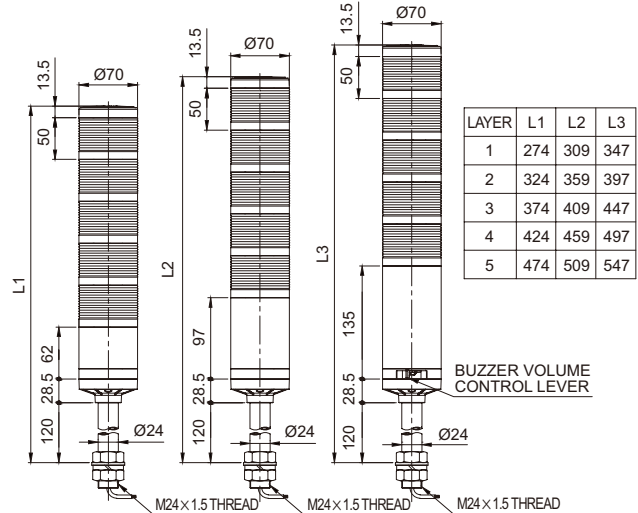
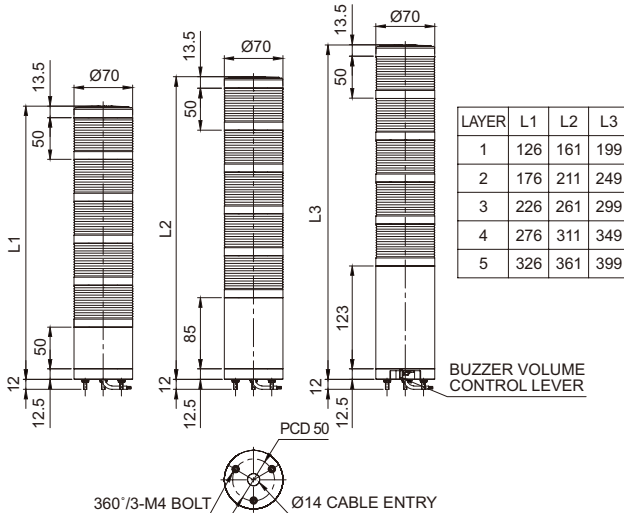

# QTG/QTC/QTR series



## Wiring Instructions(using external contact)

• In case of wiring with external contact, please select the proper transistor type : either NPN or PNP based on the source voltage setting.

Applied products	Wiring Instructions	Applied products	Wiring Instructions
<b>DC Steady</b>  QTG50ML QTG50L QTG60ML QTG60L QTG70ML QTG70L QTC50ML QTC50L QTC60ML QTC60L QTC70ML QTC70L QTR50ML QTR50L QTR60ML QTR60L QTR70ML QTR70L	<p style="text-align: center;">EXTERNAL CONTACT</p> <ul style="list-style-type: none"> <li>• QTG(A)XX(M)L - Same wiring including buzzer type</li> <li>• QTC(A)XX(M)L - Same wiring including buzzer type</li> <li>• QTR(A)XX(M)L - Same wiring including buzzer type</li> <li>• QTGXXL</li> <li>• QTCXXL</li> <li>• QTRXXL</li> </ul> <p>└ Lens diameter 50(50mm) : QTR50(M)L 60(60mm) : QTR60(M)L 70(70mm) : QTR70(M)L</p>	<b>AC Steady</b>  QTG50ML QTG50L QTG60ML QTG60L QTG70ML QTG70L QTC50ML QTC50L QTC60ML QTC60L QTC70ML QTC70L QTR50ML QTR50L QTR60ML QTR60L QTR70ML QTR70L	<p style="text-align: center;">EXTERNAL CONTACT</p> <ul style="list-style-type: none"> <li>• QTG(A)XX(M)L - Same wiring including buzzer type</li> <li>• QTC(A)XX(M)L - Same wiring including buzzer type</li> <li>• QTR(A)XX(M)L - Same wiring including buzzer type</li> <li>• QTGXXL</li> <li>• QTCXXL</li> <li>• QTRXXL</li> </ul> <p>└ Lens diameter 50(50mm) : QTR50(M)L 60(60mm) : QTR60(M)L 70(70mm) : QTR70(M)L</p>
<b>DC Steady/Flashing</b>  QTG50MLF QTG50LF QTG60MLF QTG60LF QTG70MLF QTG70LF QTC50MLF QTC50LF QTC60MLF QTC60LF QTC70MLF QTC70LF QTR50MLF QTR50LF QTR60MLF QTR60LF QTR70MLF QTR70LF	<p style="text-align: center;">EXTERNAL CONTACT</p> <ul style="list-style-type: none"> <li>• QTG(A)XX(M)L - Same wiring including buzzer type</li> <li>• QTC(A)XX(M)L - Same wiring including buzzer type</li> <li>• QTR(A)XX(M)L - Same wiring including buzzer type</li> <li>• QTGXXL</li> <li>• QTCXXL</li> <li>• QTRXXL</li> </ul> <p>└ Lens diameter 50(50mm) : QTR50(M)L 60(60mm) : QTR60(M)L 70(70mm) : QTR70(M)L</p>	<b>AC Steady/Flashing</b>  QTG50MLF QTG50LF QTG60MLF QTG60LF QTG70MLF QTG70LF QTC50MLF QTC50LF QTC60MLF QTC60LF QTC70MLF QTC70LF QTR50MLF QTR50LF QTR60MLF QTR60LF QTR70MLF QTR70LF	<p style="text-align: center;">EXTERNAL CONTACT</p> <ul style="list-style-type: none"> <li>• QTG(A)XX(M)L - Same wiring including buzzer type</li> <li>• QTC(A)XX(M)L - Same wiring including buzzer type</li> <li>• QTR(A)XX(M)L - Same wiring including buzzer type</li> <li>• QTGXXL</li> <li>• QTCXXL</li> <li>• QTRXXL</li> </ul> <p>└ Lens diameter 50(50mm) : QTR50(M)L 60(60mm) : QTR60(M)L 70(70mm) : QTR70(M)L</p>

- DC steady type : External power/ External signal line : UL1007 AWG22(0.3sq) 400mm
- AC steady, AC/DC steady/flashing type : External power line : UL1015 AWG18(0.75sq)×2C 400mm  
External signal line : UL1007 AWG22(0.3sq) 400mm

# QTG/QTC/QTR series



## Wiring Instructions(using transistor)

• In case of wiring with transistors, please select the proper transistor type : either NPN or PNP based on the source voltage setting.

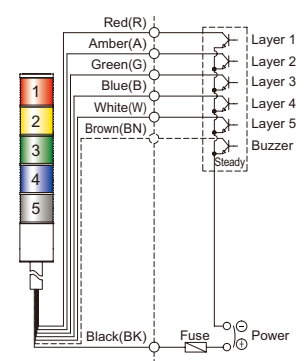
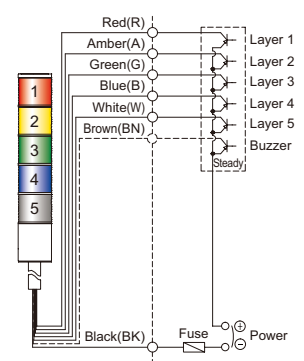
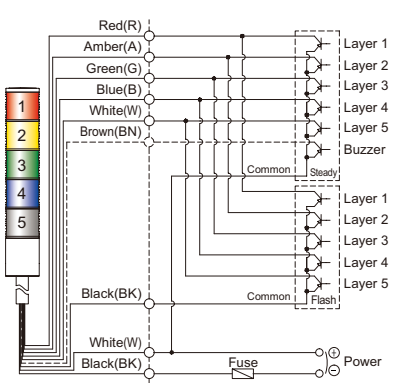
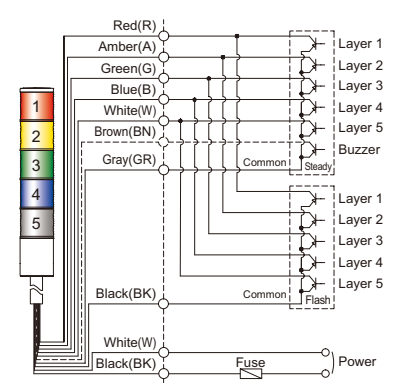
Applied products	Wiring Instructions	
<p>DC Steady</p> <p>QTG50ML QTG50L QTG60ML QTG60L QTG70ML QTG70L QTC50ML QTC50L QTC60ML QTC60L QTC70ML QTC70L QTR50ML QTR50L QTR60ML QTR60L QTR70ML QTR70L</p>	<p>EXTERNAL TRANSISTOR-NPN</p>  <ul style="list-style-type: none"> <li>• QTG(A)XX(M)L - Same wiring including buzzer type</li> <li>• QTC(A)XX(M)L - Same wiring including buzzer type</li> <li>• QTR(A)XX(M)L - Same wiring including buzzer type</li> <li>• QTGXXL</li> <li>• QTCXXL</li> <li>• QTRXXL</li> <li>└ Lens diameter 50(50mm) : QTR50(M)L</li> <li>60(60mm) : QTR60(M)L</li> <li>70(70mm) : QTR70(M)L</li> </ul>	<p>EXTERNAL TRANSISTOR-PNP</p> 
<p>DC Steady/Flashing</p> <p>QTG50MLF QTG50LF QTG60MLF QTG60LF QTG70MLF QTG70LF QTC50MLF QTC50LF QTC60MLF QTC60LF QTC70MLF QTC70LF QTR50MLF QTR50LF QTR60MLF QTR60LF QTR70MLF QTR70LF</p>	<p>EXTERNAL TRANSISTOR-PNP</p>  <ul style="list-style-type: none"> <li>• QTG(A)XX(M)L - Same wiring including buzzer type</li> <li>• QTC(A)XX(M)L - Same wiring including buzzer type</li> <li>• QTR(A)XX(M)L - Same wiring including buzzer type</li> <li>• QTGXXL</li> <li>• QTCXXL</li> <li>• QTRXXL</li> <li>└ Lens diameter 50(50mm) : QTR50(M)L</li> <li>60(60mm) : QTR60(M)L</li> <li>70(70mm) : QTR70(M)L</li> </ul>	<p>AC Steady/Flashing</p> <p>QTG50MLF QTG50LF QTG60MLF QTG60LF QTG70MLF QTG70LF QTC50MLF QTC50LF QTC60MLF QTC60LF QTC70MLF QTC70LF QTR50MLF QTR50LF QTR60MLF QTR60LF QTR70MLF QTR70LF</p> <p>EXTERNAL TRANSISTOR-PNP</p>  <ul style="list-style-type: none"> <li>• QTG(A)XX(M)L - Same wiring including buzzer type</li> <li>• QTC(A)XX(M)L - Same wiring including buzzer type</li> <li>• QTR(A)XX(M)L - Same wiring including buzzer type</li> <li>• QTGXXL</li> <li>• QTCXXL</li> <li>• QTRXXL</li> <li>└ Lens diameter 50(50mm) : QTR50(M)L</li> <li>60(60mm) : QTR60(M)L</li> <li>70(70mm) : QTR70(M)L</li> </ul>

- DC steady type : External power/ External signal line : UL1007 AWG22(0.3sq) 400mm
- AC steady, AC/DC steady/flashing type : External power line : UL1015 AWG18(0.75sq)\*2C 400mm
- External signal line : UL1007 AWG22(0.3sq) 400mm