

Modular LED signal tower light with built-in terminal

MTG70/ MTC70/ MTR70 Series

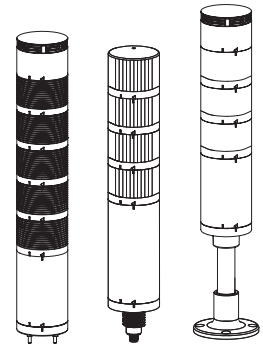

Thank you for purchasing Qlight's products. Please read this user manual carefully prior to installation and operation to ensure safe and correct use.

⚠ Precautions for Safety

Failure to follow the instructions below may cause a loss of life or serious physical injury.

1. During wiring or maintenance, please completely turn off the power of the product. (Failure to follow this may lead to an electric shock.)
2. Do not install the product in locations that subjects it to excessive dust or water other than the conditions designated by the IP protection ratings indicated for each product. (Failure to follow these instructions may cause a fire to the product, electric shock, physical injury, malfunction or damage to the product.)
3. Do not alter or repair this product. If maintenance or repair service is required, please contact your local Qlight contact point. (Failure to follow these instructions may lead to fire, electric shock, or product damage.)
4. Please apply the correct voltage to the product. (Failure to follow these instructions may lead to fire, electric shock, or product damage.)
5. When the product is applied to a condition that may impact lives or property, please make sure to have a double safety device. (Failure to follow this may cause damage to property, fire, electric shock and loss of life.)

⚠ Precautions for Correct Use



Failure to follow the proper instructions may cause damage to property, the product, or malfunction of the product that would void the warranty.

1. Please remove any objects that can interrupt ventilation around the product.
2. Please turn off the power of the product immediately if it fails to operate properly.
3. Carefully wire the product according to each product's specification.
4. Please be careful in preventing chemicals such as thinner, benzene, etc. in contact with the surface of the product.
5. Do not apply excessive force/impact to the product.
6. Failure to follow any of the instructions above may cause malfunction or damage to the product, fire, and electric shock.

Ordering Specifications

• Cover

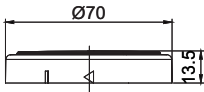
(Units : mm)

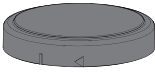
| Shape | Parts Name | Model No | Color | Common Specifications |
|---|-------------|------------|--------|---|
|  | MTG70 cover | MG70-CV | Ivory | <ul style="list-style-type: none"> • Material: ABS • Protection ratings with assemble: IP65 • Product size: Ø70 X 14  |
|  | MTG70 cover | MG70-CV-SV | Silver | |
|  | MTG70 cover | MG70-CV-BK | Black | |



Please scan the QR code for more detailed product information.

www.qlight.com

Ordering Specifications

• Buzzer module

(Units : mm)

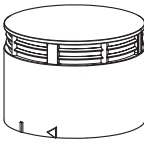
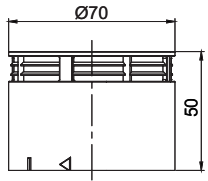
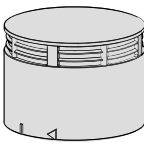
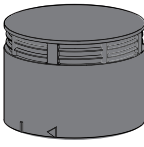
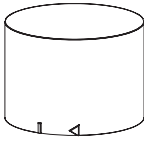
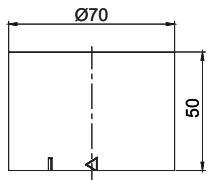
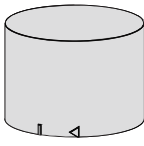
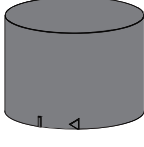
| Shape | Parts Name | Model No | Color | Specification | | Volume(dB) | Common Specifications |
|---|---------------------------------|----------------|--------|---------------|---------|------------|--|
| | | | | Voltage | Current | | |
|  | MTG70-High-volume buzzer module | MG70-HBZ-24 | Ivory | DC24V | 0.080A | Max.100dB | <ul style="list-style-type: none"> • Material: ABS • Protection ratings with assemble : Non-Waterproof • Product size: Ø70 X 50  |
|  | MTG70-High-volume buzzer module | MG70-HBZ-24-SV | Silver | DC24V | 0.080A | Max.100dB | |
|  | MTG70-High-volume buzzer module | MG70-HBZ-24-BK | Black | DC24V | 0.080A | Max.100dB | |
|  | MTG70-Waterproof buzzer module | MG70-WBZ-24 | Ivory | DC24V | 0.080A | Max.85dB | <ul style="list-style-type: none"> • Material: ABS • Protection ratings with assemble: IP65 • Product size: Ø70 X 50  |
|  | MTG70-Waterproof buzzer module | MG70-WBZ-24-SV | Silver | DC24V | 0.080A | Max.85dB | |
|  | MTG70-Waterproof buzzer module | MG70-WBZ-24-BK | Black | DC24V | 0.080A | Max.85dB | |

Ordering Specifications

• Cover integrated Lens option is available

(Units : mm)

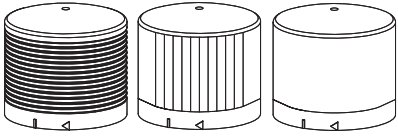
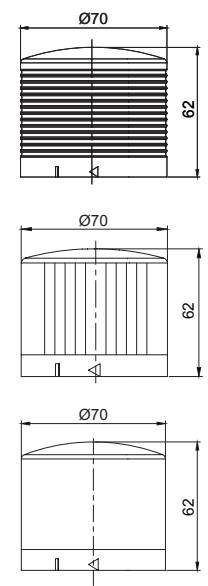
| Shape | | | Model No | Color | Specification | | Common Specifications |
|---|----|----|--|-------|---------------|---------|---|
| MG | MC | MR | | | Voltage | Current | |
|  | | | MGA70-R-24 MCA70-R-24 MRA70-R-24 | Red | DC24V | 0.050A | <ul style="list-style-type: none"> • Material: PC • Protection ratings with assemble: IP65 • Product size: Ø70 X 62  |

• LED Steady/Flashing Module



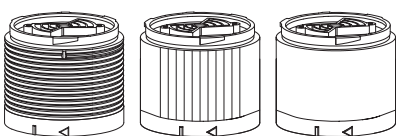
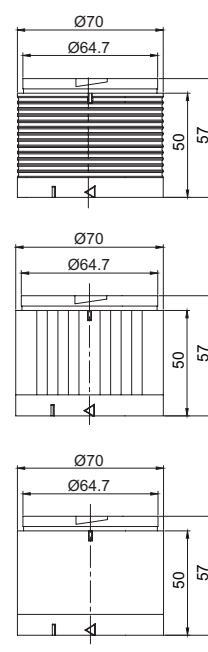
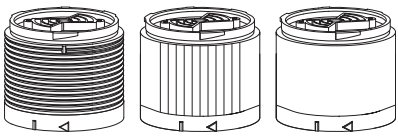
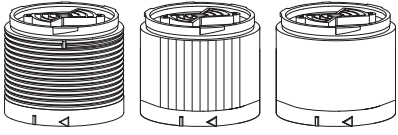
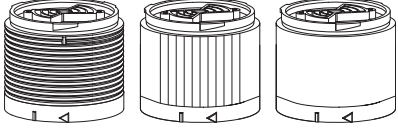
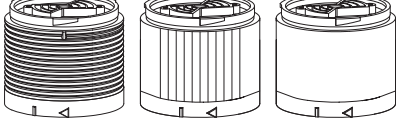



(Units : mm)

| Shape | | | Model No | Color | Specification | | Common Specifications |
|---|----|----|-------------------------------------|-------|---------------|---------|--|
| MG | MC | MR | | | Voltage | Current | |
|  | | | MG70-R-24 MC70-R-24 MR70-R-24 | Red | DC24V | 0.050A | <ul style="list-style-type: none"> • Material: PC • Protection ratings with assemble: IP65 • Product size: Ø70 X 57  |
|  | | | MG70-A-24 MC70-A-24 MR70-A-24 | Amber | DC24V | 0.050A | |
|  | | | MG70-G-24 MC70-G-24 MR70-G-24 | Green | DC24V | 0.050A | |
|  | | | MG70-B-24 MC70-B-24 MR70-B-24 | Blue | DC24V | 0.050A | |
|  | | | MG70-W-24 MC70-W-24 MR70-W-24 | White | DC24V | 0.050A | |

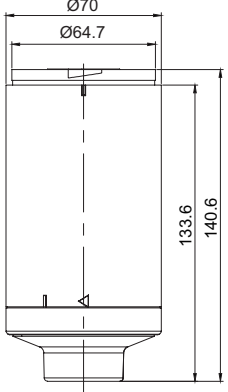
Ordering Specifications

• Base module(Pole mount type)

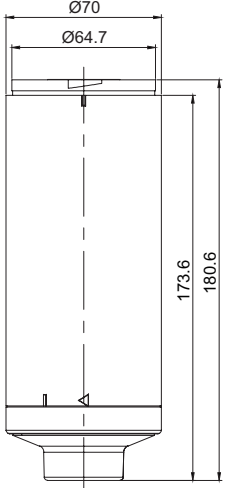



(Units : mm)

| Shape | Parts Name | Model No | Color | Specification | | Common Specifications |
|---|--------------------------------|---------------|--------|---------------|---------|--|
| | | | | Voltage | Current | |
|  | MTG70-POLE type base module-DC | MG70-BS-DC | Ivory | DC24V | - | <ul style="list-style-type: none"> • Material: ABS • Protection ratings with assemble: IP65 • Product size: Ø70 X 141  |
|  | MTG70-POLE type base module-DC | MG70-BS-DC-SV | Silver | DC24V | - | |
|  | MTG70-POLE type base module-DC | MG70-BS-DC-BK | Black | DC24V | - | |
|  | MTG70-POLE type base module-AC | MG70-BS-AC | Ivory | AC110-220V | 0.035A | <ul style="list-style-type: none"> • Material: ABS • Protection ratings with assemble: IP65 • Product size: Ø70 X 181  |
|  | MTG70-POLE type base module-AC | MG70-BS-AC-SV | Silver | AC110-220V | 0.035A | |
|  | MTG70-POLE type base module-AC | MG70-BS-AC-BK | Black | AC110-220V | 0.035A | |

Ordering Specifications

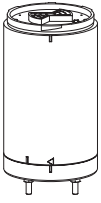
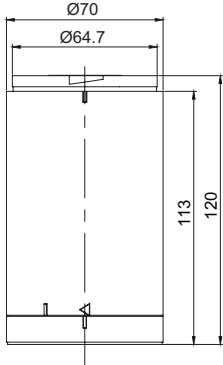
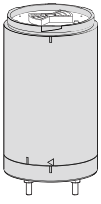
• Base module(Self stand type)

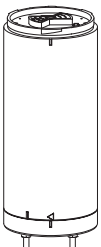
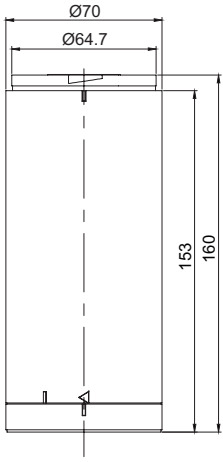
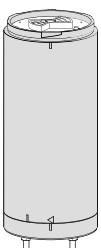



(Units : mm)

| Shape | Parts Name | Model No | Color | Specification | | Common Specifications |
|---|---------------------------------|----------------|--------|---------------|---------|--|
| | | | | Voltage | Current | |
|  | MTG70-Self stand base module-DC | MG70-MBS-DC | Ivory | DC24V | - | <ul style="list-style-type: none"> • Material: ABS • Protection ratings with assemble: IP65 • Product size: Ø70 X 120  |
|  | MTG70-Self stand base module-DC | MG70-MBS-DC-SV | Silver | DC24V | - | |
|  | MTG70-Self stand base module-DC | MG70-MBS-DC-BK | Black | DC24V | - | |
|  | MTG70-Self stand base module-AC | MG70-MBS-AC | Ivory | AC110-220V | 0.035A | <ul style="list-style-type: none"> • Material: ABS • Protection ratings with assemble: IP65 • Product size: Ø70 X 170  |
|  | MTG70-Self stand base module-AC | MG70-MBS-AC-SV | Silver | AC110-220V | 0.035A | |
|  | MTG70-Self stand base module-AC | MG70-MBS-AC-BK | Black | AC110-220V | 0.035A | |

Ordering Specifications

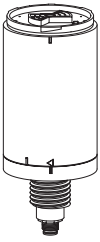
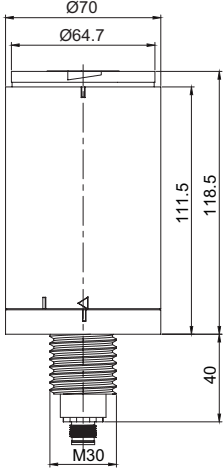
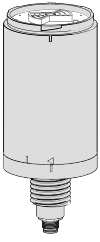
• Base module(M12 CONNECTOR type)

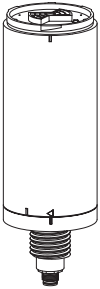
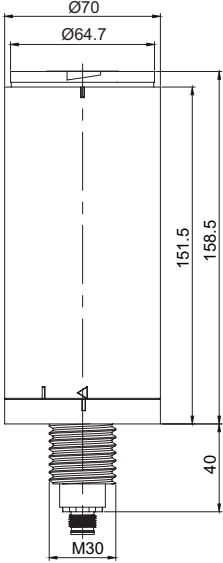
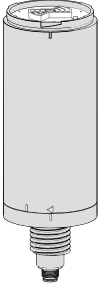
(Units : mm)

| Shape | Parts Name | Model No | Color | Specification | | Common Specifications |
|---|---|-------------------|--------|---------------|---------|--|
| | | | | Voltage | Current | |
|  | MTG70-M12 CONNECTOR type base module- DC | MG70-BS-DC-M12 | Ivory | DC24V | - | <ul style="list-style-type: none"> • Material: ABS • Protection ratings with assemble: IP65 • Product size: Ø70 X 119  |
|  | MTG70-M12 CONNECTOR type base module- DC | MG70-BS-DC-M12-SV | Silver | DC24V | - | |
|  | MTG70-M12 CONNECTOR type base module- DC | MG70-BS-DC-M12-BK | Black | DC24V | - | |
|  | MTG70-M12 CONNECTOR type base module- AC | MG70-BS-AC-M12 | Ivory | AC110-220V | 0.035A | <ul style="list-style-type: none"> • Material: ABS • Protection ratings with assemble: IP65 • Product size: Ø70 X 159  |
|  | MTG70-M12 CONNECTOR type base module- AC | MG70-BS-AC-M12-SV | Silver | AC110-220V | 0.035A | |
|  | MTG70-M12 CONNECTOR type base module- AC | MG70-BS-AC-M12-BK | Black | AC110-220V | 0.035A | |

How to configure module

• Model No/ Shape

• Assembly step

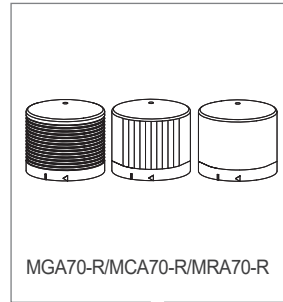
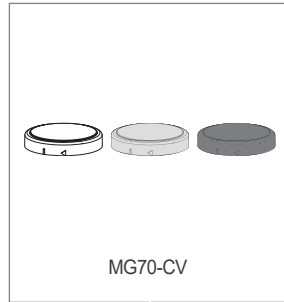
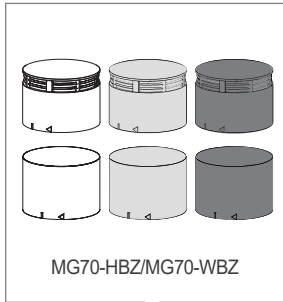

Assembly Step 1

- Choose from cover, buzzer module, and cover lens integrated module
- Please refer to detailed module specification in order to find out model number

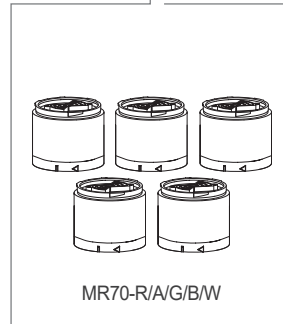
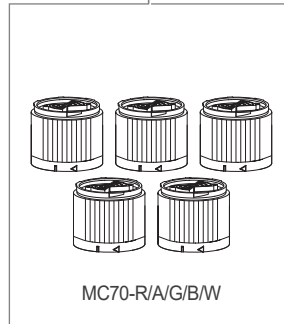
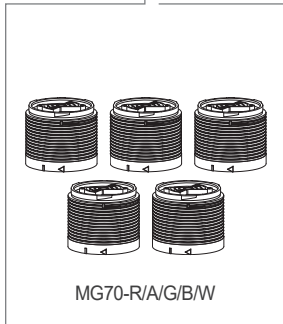

Assembly Step 2

- Select among MTG, MTC, MTR LED module
- When the buzzer module is selected in the first stage of module assembly, only 4 levels of R/A/G/B colors can be used for the LED module (W color cannot be used)
- If the operating voltage is AC type, the LED module uses DC24V type.
- When selecting MTR LED module, please choose black base module
- Please refer to detailed module specification in order to find out model number

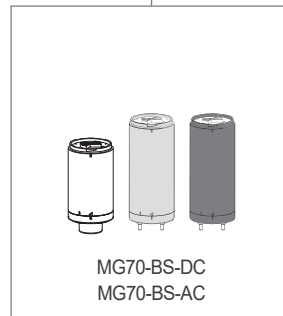
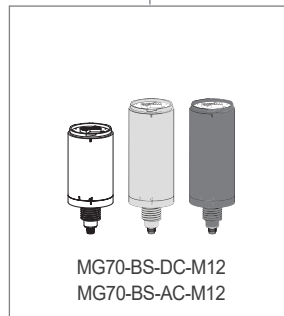
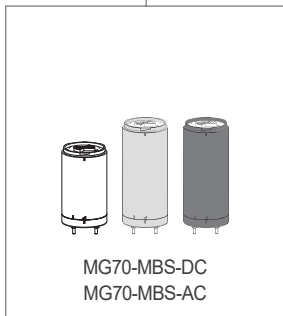

Assembly Step 3

- Please select among direct mount, pole mount, and M12-CONNECTOR type base module
- Please refer to detailed module specification in order to find out model number

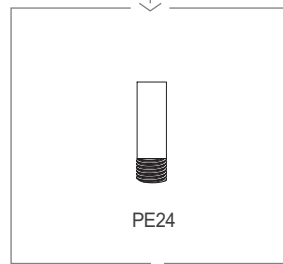
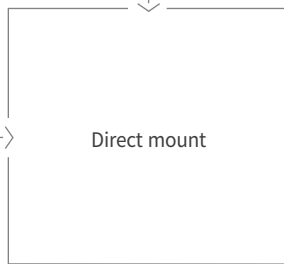

Assembly Step 4

- In case of using POLE type based module at the Assembly Step 3, you should select a pole. The pole can be provided with diverse length.
- Please refer to detailed module specification in order to find out model number

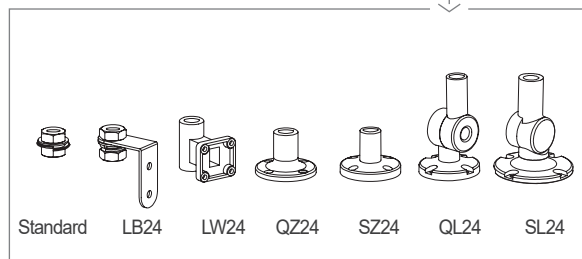
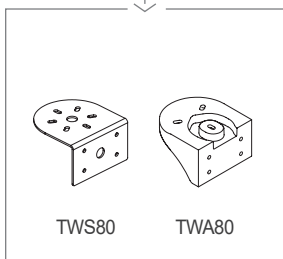

Assembly Step 5

- Please select appropriate mounting bracket in accordance with your needs
- Please refer to detailed module specification in order to find out model number

Wiring Instructions

■ Wiring using external contact

- In case of wiring with external contacts, refer to the wiring diagrams below according to your product's type and voltage setting.

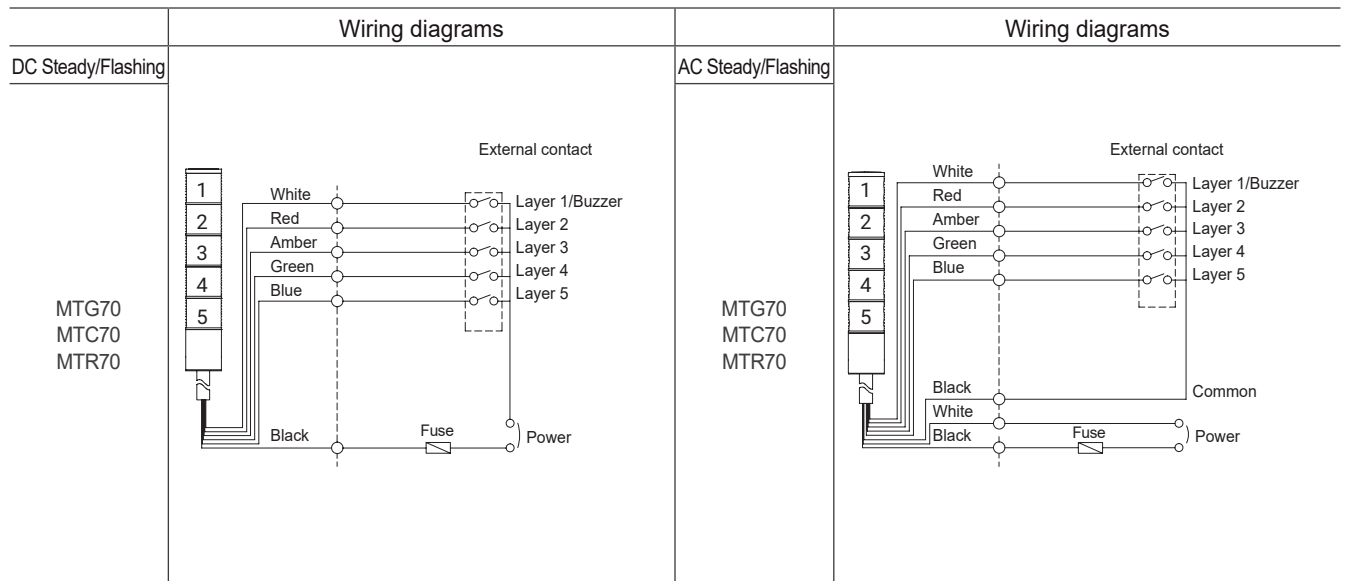

- DC steady type cable specification: External power/ signal line - UL1007 AWG22(0.3sq) 400mm
- AC steady, AC/DC steady/flashing type cable specification : External power line - UL1015 AWG18(0.75sq) × 2C 400mm, External signal line - UL1007 AWG22(0.3sq) 400mm

■ Wiring using transistor

- When using a transistor, please choose between the NPN or PNP type transistor which best matches the voltage and product type, then connect them correctly according to the wiring diagrams below.

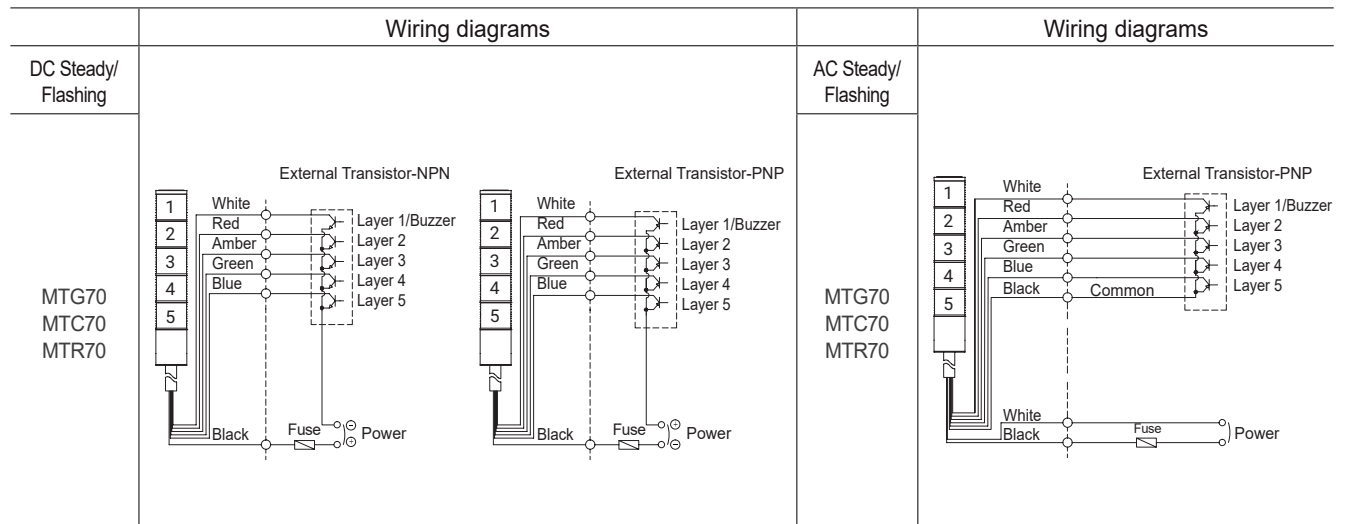

- DC steady type cable specification: External power/ signal line - UL1007 AWG22(0.3sq) 400mm
- AC steady, AC/DC steady/flashing type cable specification : External power line - UL1015 AWG18(0.75sq) × 2C 400mm, External signal line - UL1007 AWG22(0.3sq) 400mm

■ Wiring Instructions

- External power line - UL1015 AWG18(0.75sq) x 2C 400mm
- External signal line - UL1007 AWG22(0.3sq) 400mm
- LED light source tower lamp can be connected using external contacts and transistors

Example of MTG70 module configuration

- You can assemble the product through module combination by referring to the diagram below.
- When a buzzer module (high volume buzzer module/waterproof buzzer module) is combined, only 4 LED modules can be assembled (W color module cannot be assembled).

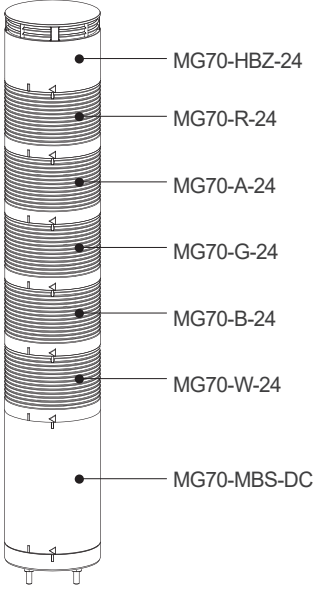
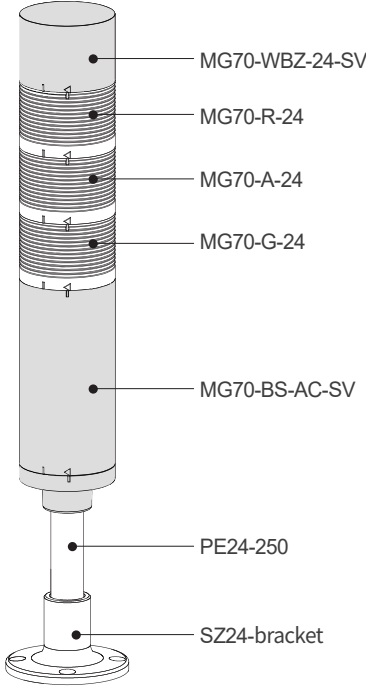
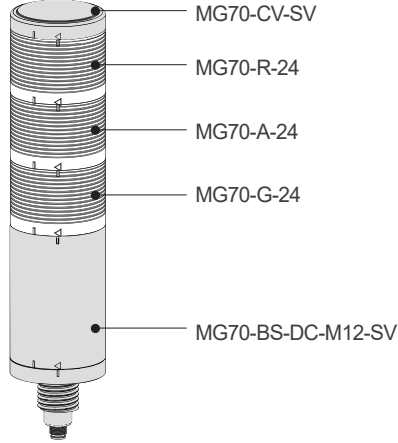
| MTG70ML-HBZ-24-5-RAGBW | | MTG70L-WBZ-110/220-3-RAG-SZ24-SV | | MTG70L-24-3-RAG-M12-SV | |
|--|---------|---|---------|--|---------|
| Shape | Modules | Shape | Modules | Shape | Modules |
|  | |  | |  | |
| Buzzer module + LED module + MBS module(Self stand type module) | | Buzzer module-Silver + LED module + BS module-Silver(Pole type module) + POLE + Bracket | | Cover module-Silver + LED module + BS module-Silver (M12 CONNECTOR type module) | |

Ordering Specifications

| | | | | | | | | |
|--|---|--|---|--|---|---|---|--|
| MG70-WBZ-24-SV | - | MG70-R/A/G/B-24 | - | MG70-BS-AC-SV | - | PE24-250 | - | SZ24 |
| [Upper module] | | [LED module] | | [Base module] | | [Pole] | | [Bracket] |
| <ul style="list-style-type: none"> • Cover module • Buzzer module • Cover integrated Lens option is available | | R-Red A-Amber G-Green B-Blue W-White | | <ul style="list-style-type: none"> • Pole mount type • Self stand type • M12 CONNECTOR type | | <ul style="list-style-type: none"> • (Blank)None-Self stand type, • M12 CONNECTOR type • POLE type | | <ul style="list-style-type: none"> • (Blank)None-Self stand type, • M12 CONNECTOR type • POLE type, Self stand type(Optional) |

Example of MTG70 module configuration

- You can assemble the product through module combination by referring to the diagram below.
- When a buzzer module (high volume buzzer module/waterproof buzzer module) is combined, only 4 LED modules can be assembled (W color module cannot be assembled).

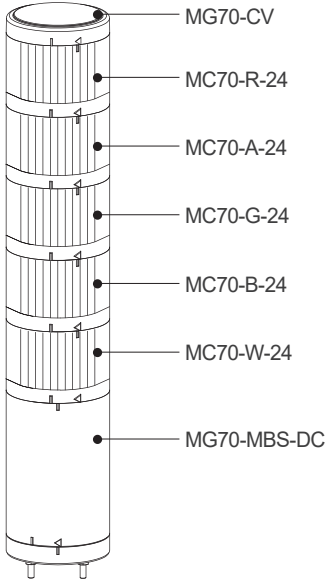
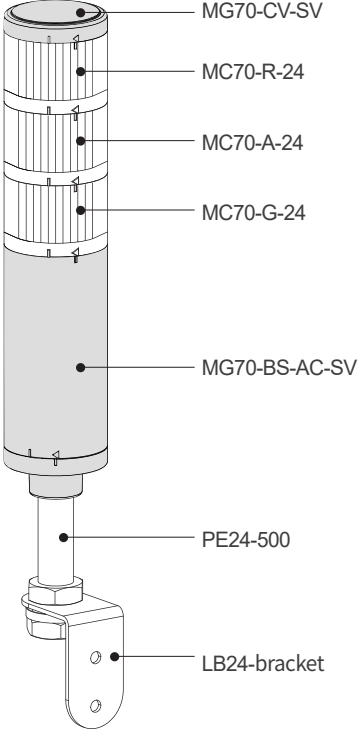
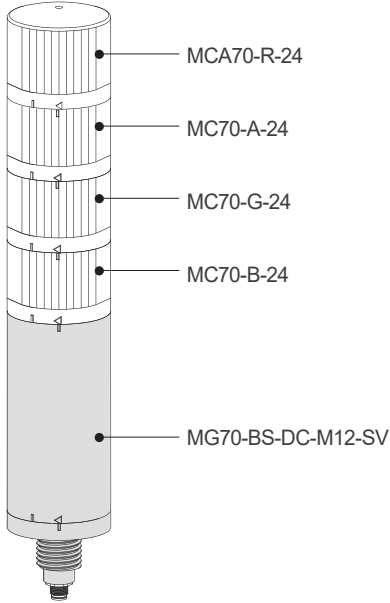
| MTC70ML-24-5-RAGBW | | MTC70L-110/220-3-RAG-LB24-SV | | MTCA70L-24-4-RAGB-M12-SV | |
|--|---------|--|---------|--|---------|
| Shape | Modules | Shape | Modules | Shape | Modules |
|  | |  | |  | |
| Cover module + LED module + MBS module(Self stand type module) | | Cover module-Silver + LED module + BS module-Silver(Pole type module) + POLE + Bracket | | Cover integrated Lens option LED module + LED module + BS module-Silver (M12 CONNECTOR type module) | |

Ordering Specifications

| | | | | | | | | |
|--|---|--|---|--|---|---|---|--|
| MG70-CV-SV | - | MC70-R/A/G/B-24 | - | MG70-BS-AC-SV | - | PE24-500 | - | LB24 |
| [Upper module] | | [LED module] | | [Base module] | | [Pole] | | [Bracket] |
| <ul style="list-style-type: none"> • Cover module • Buzzer module • Cover integrated Lens option is available | | R-Red A-Amber G-Green B-Blue W-White | | <ul style="list-style-type: none"> • Pole mount type • Self stand type • M12 CONNECTOR type | | <ul style="list-style-type: none"> • (Blank)None-Self stand type, • M12 CONNECTOR type • POLE type | | <ul style="list-style-type: none"> • (Blank)None-Self stand type, • M12 CONNECTOR type • POLE type, Self stand type(Option) |

Example of MTG70 module configuration

- You can assemble the product through module combination by referring to the diagram below.
- When a buzzer module (high volume buzzer module/waterproof buzzer module) is combined, only 4 LED modules can be assembled (W color module cannot be assembled).

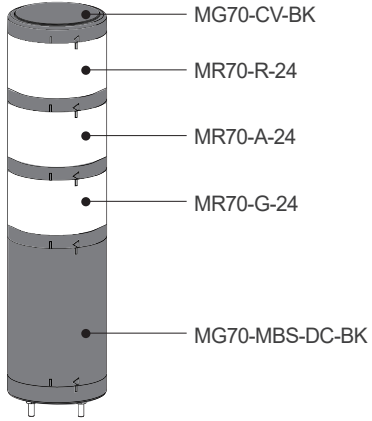
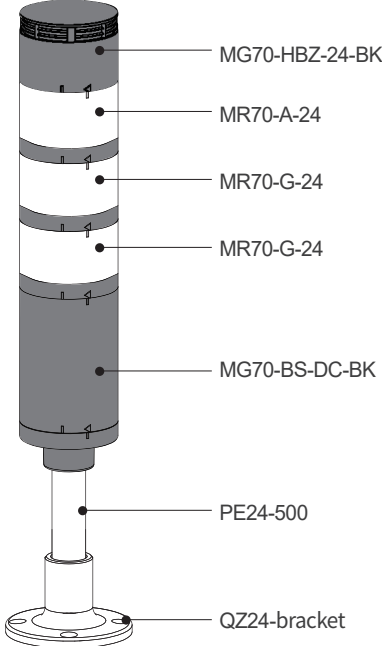
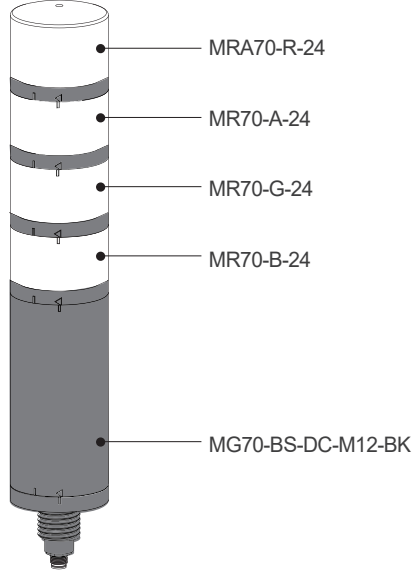
| MTR70ML-24-3-RAG-BK | | MTR70L-HBZ-24-3-RAG-QZ24-BK | | MTRA70L-24-4-RAGB-M12-BK | |
|---|---------|---|---------|---|---------|
| Shape | Modules | Shape | Modules | Shape | Modules |
|  | |  | |  | |
| over module-Black + LED module + MBS module-Black (Self stand type module) | | Buzzer module-Black + LED module + BS module-Black(Pole type module) + POLE + Bracket | | Cover integrated Lens option LED module + LED module + BS module-Black (M12 CONNECTOR type module) | |

Ordering Specifications

| | | | | | | | | |
|--|---|--|---|--|---|---|---|--|
| MG70-HBZ-24-BK | - | MR70-R/A/G/B/W-24 | - | MG70-BS-DC-BK | - | PE24-500 | - | QZ24 |
| [Upper module] | | [LED module] | | [Base module] | | [Pole] | | [Bracket] |
| <ul style="list-style-type: none"> • Cover module • Buzzer module • Cover integrated Lens option is available | | R-Red A-Amber G-Green B-Blue W-White | | <ul style="list-style-type: none"> • Pole mount type • Self stand type • M12 CONNECTOR type | | <ul style="list-style-type: none"> • (Blank)None-Self stand type, • M12 CONNECTOR type • POLE type | | <ul style="list-style-type: none"> • (Blank)None-Self stand type, • M12 CONNECTOR type • POLE type, Self stand type(Option) |

How to Change Lens Kit

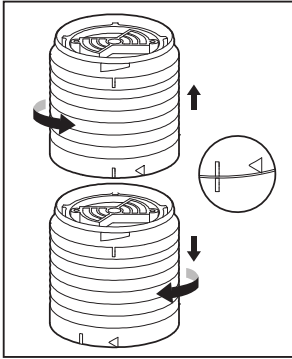

• Disassembling lens kits

- ① Twist the upper lens kit in a counter-wise direction so the "I" mark from both kits align.
- ② Disassemble by removing the upper lens kit from the lower one.

※ Cautions

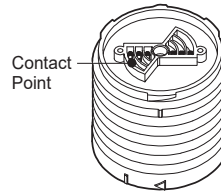

Lens modules are connected through cone-shaped contact point. In case the contact point is damaged, it may cause a contact failure.

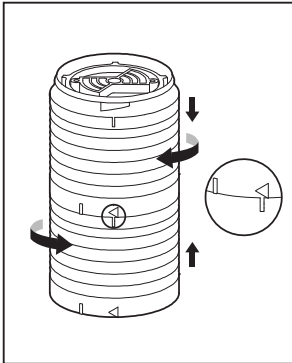

• Assembling lens kits

- ① Put the two lens kits together by aligning the upper lens' "I" mark and the lower lens' "I" mark together.
- ② Lock the two kits by twisting the upper lens kit in a counter-wise direction so the upper lens' "I" mark aligns with the lower lens' "I" mark.

Mounting Hole Specifications

■ MTG70 Self stand base module DC/ Self stand base module AC

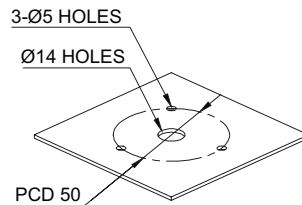

- ① Machine holes on the mounting surface referring to the diagram below.
- ② Remove the flange nuts from bolts and place the product through the mounting surface holes.
- ③ Fasten the flange nuts on the opposite side of the mounting surface until the product is tightened securely.

Installation Environment and Protection Rating

- This product is designed for indoor use with protection rating of Non-Waterproof(High-volume buzzer type)/ IP65(Waterproof buzzer type).
- If the product is installed in locations that subject it to excessive dust or water other than the designated IP protection rating indicated(IP65), it may cause malfunction or damage to the product.
- For further information, please visit our website(www.qlight.com).

Mounting Accessories (Sold Separately)

• Please refer to the dimensions below for installation of mounting brackets.

■ MTG70 Self stand base module DC/ module AC

| | | Dimensions |
|----------------------------------|---------------------|---------------------|
| <p>MTG70 MTC70 MTR70</p> | <p>TWS80</p> | <p>TWA80</p> |

Mounting Accessories (Sold Separately)

■ MTG70-Pole mount type module DC/ module AC

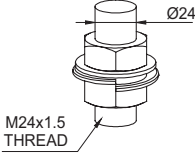
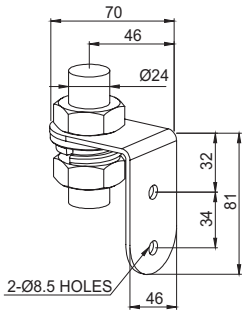
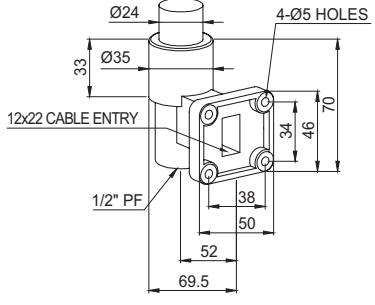
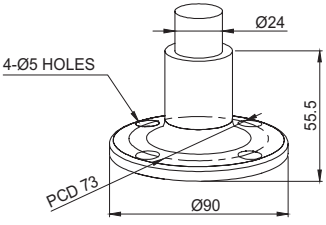
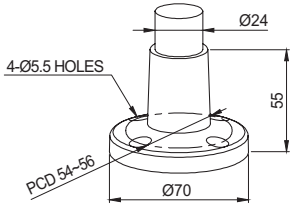
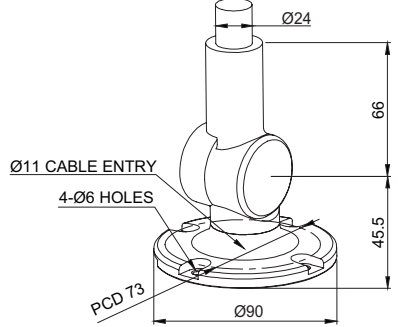
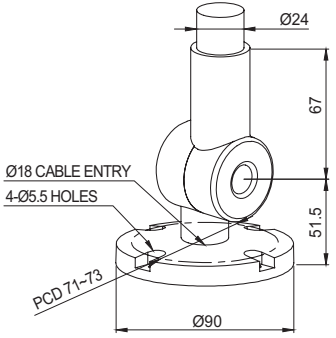
| | | Dimensions | |
|---|--|---|---|
| MTG70 MTC70 MTR70 |  <p>M24x1.5 THREAD</p> | | |
| | 24mm SCREW & NUT | |  <p>70 46 Ø24 32 34 81 2-Ø8.5 HOLES 46</p> |
| | LB24 | | |
| |  <p>Ø24 33 Ø35 12x22 CABLE ENTRY 1/2" PF 4-Ø5 HOLES 34 46 70 38 50 52 69.5</p> | | |
| | LW24 | |  <p>Ø24 4-Ø5 HOLES PCD 73 Ø90 55.5</p> |
| SZ24 | | | |
|  <p>Ø24 4-Ø5.5 HOLES PCD 54-56 Ø70 56</p> | | | |
| QZ24 | |  <p>Ø24 66 Ø11 CABLE ENTRY 4-Ø6 HOLES PCD 73 Ø90 45.5</p> | |
| SL24 | | | |
|  <p>Ø24 67 Ø18 CABLE ENTRY 4-Ø5.5 HOLES PCD 71-73 Ø90 51.5</p> | | | |
| QL24 | | | |

Product installation direction

- Install the product in accordance with the manual. Otherwise rainwater or moisture may penetrate into the product.

· BEACON/SIGNALING LIGHT

※ For products with a protection rating of less than IPX4, please install it vertically.

Power cord inlet part shall not be facing the sky.

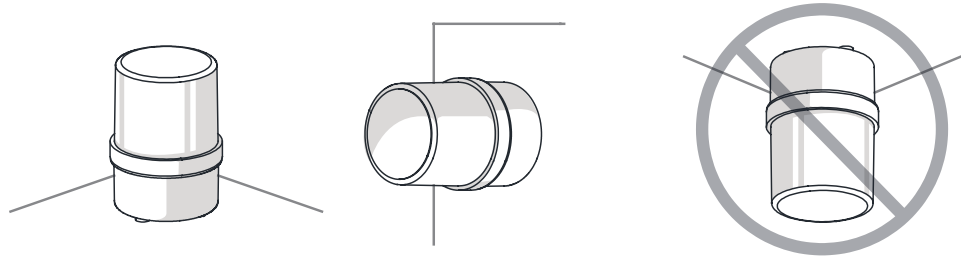

· ELECTRONIC SOUNDER/SIGNAL HORN

Sounder part shall not be facing the sky.

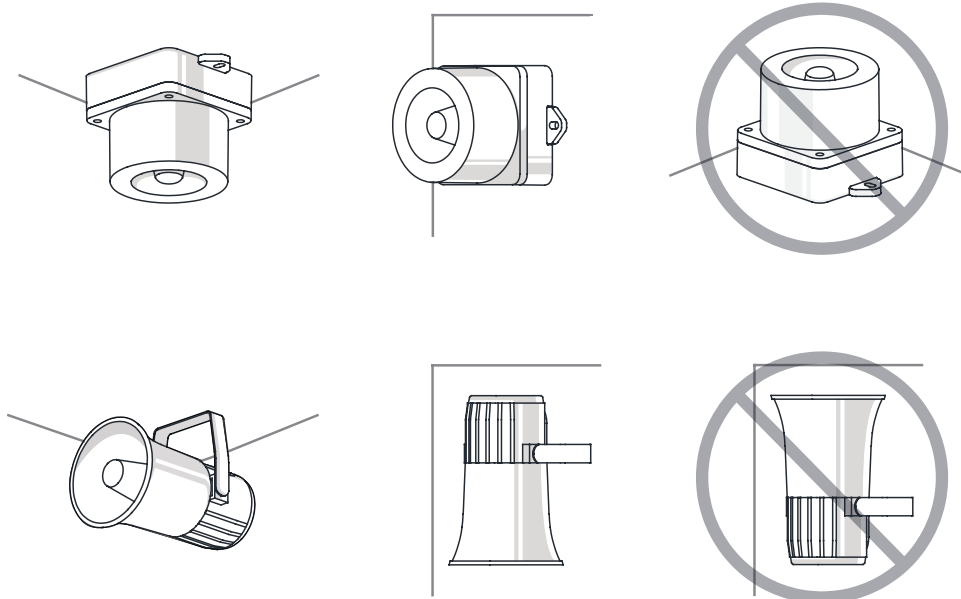

· HEAVY-DUTY & EXPLOSION PROOF SIGNALINGS

Sounder part shall not be facing the sky.

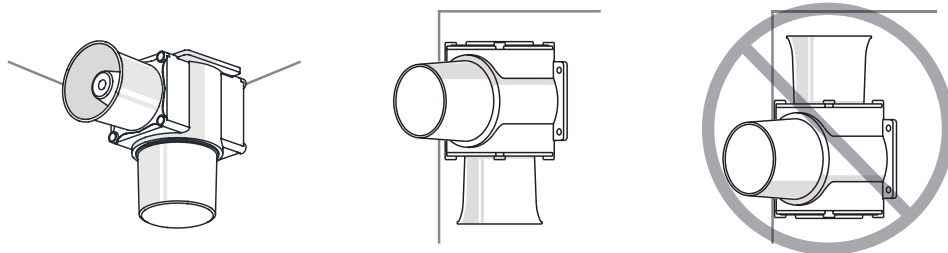

· SIGNAL TOWER LIGHTS

※ For products with a protection rating of less than IPX4, please install it vertically.

Power cord inlet part shall not be facing the sky.

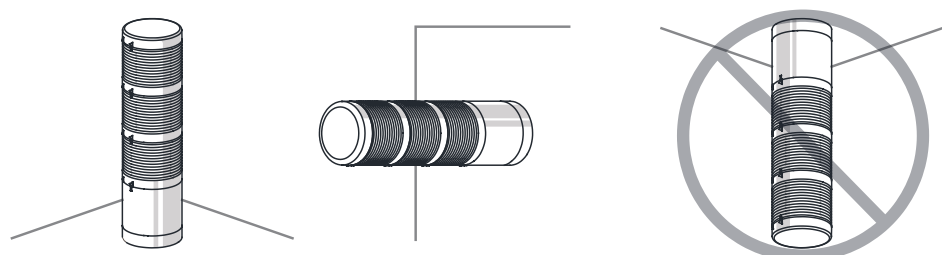



For your safety

Specification and dimensions listed in this catalogue subject to change without notice for product quality improvement.
The newest product information is available on our website.(www.qlight.com)
Please read the instruction manual attached to the product carefully before installation and use.

Qlight Co., Ltd. www.qlight.com | trade@qlight.com

Head Office | Suite #1510, STX-V Tower, 128 Gasan digital 1-ro, Geumcheon-gu, Seoul, Korea

Tel. +82-2-2679-6152(Toll free. +82-80-328-2222) Fax. +82-2-2679-6154

Factory | 185-25, Mukbang-ro, Sangdong-myeon, Gimhae-si, Gyeongsangnamdo, Korea Tel. +82-55-328-1111(Toll free. +82-80-328-1111)

Qlight OverSEAs Sales Dept | 704 Nakdong-daero, Sasang-gu, Busan, Korea(Eomgung-Dong) Tel : +82-51-620-4100

Qlight Public Relations & Marketing Team Office | 704 Nakdong-daero, Sasang-gu, Busan, Korea(Eomgung-Dong) Tel. +82-51-245-0017

Qlight USA, Inc. www.qlight.com www.qlightusa.com | sales@qlightusa.com

3003 North First Street, Suite #341, San Jose, CA 95134 USA Tel. +1-408-519-5740 Fax. +1-408-519-5739

SHANGHAI Qlight Electronic Co., Ltd. www.qlight.com www.qlightcn.com | qlightcn@qlight.com

China Factory/ Shanghai Sales Office | #19, Nanda Road, Baoshan Area, Shanghai, China Tel. +86-21-6651-7100 Fax. +86-21-6315-3929

China Factory Site 2 (Qidong) | #33, Haiyan Road, Qidong High-tech Industrial Development Zone, Qidong, Jiangsu Province, China

Tel +86-513-8384-9999 Fax +86-513-8384-9910

Qlightec

Innovation in Alarm & Signal

Product Operation Inquiry / Customer Support +82-51-620-4100

You can expect prompt service if you have exact information such as model name, symptom, telephone number and address.

※ ALL PRODUCT, PRODUCT SPECIFICATIONS AND DATA ARE SUBJECT TO CHANGE WITHOUT NOTICE TO IMPROVE RELIABILITY, FUNCTION OR DESIGN OR OTHERWISE.

Head office : Suite #1510, STX-V Tower, 128 Gasan digital 1-ro, Geumcheon-gu, Seoul, Korea (Postal Code : 08507)

Factory : 185-25, Mukbang-Ro, Sangdong-Myeon, Gimhae-Si, Gyeongsangnam-Do, Korea (Postal Code : 50805)

www.qlight.com

EN - MTG70 - 2302A