

Bulb Revolving Warning Light

S125R/ S125U

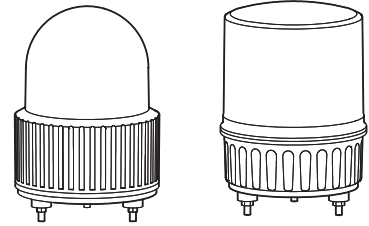

Thank you for purchasing Qlight's products. Please read this user manual carefully prior to installation and operation to ensure safe and correct use.

⚠ Precautions for Safety

Failure to follow the instructions below may cause a loss of life or serious physical injury.

1. During wiring or maintenance, please completely turn off the power of the product. (Failure to follow this may lead to an electric shock.)
2. Do not install the product in locations that subjects it to excessive dust or water other than the conditions designated by the IP protection ratings indicated for each product. (Failure to follow these instructions may cause a fire to the product, electric shock, physical injury, malfunction or damage to the product.)
3. Do not alter or repair this product. If maintenance or repair service is required, please contact your local Qlight contact point. (Failure to follow these instructions may lead to fire, electric shock, or product damage.)
4. Please apply the correct voltage to the product. (Failure to follow these instructions may lead to fire, electric shock, or product damage.)
5. When the product is applied to a condition that may impact lives or property, please make sure to have a double safety device. (Failure to follow this may cause damage to property, fire, electric shock and loss of life.)

⚠ Precautions for Correct Use

Failure to follow the proper instructions may cause damage to property, the product, or malfunction of the product that would void the warranty.

1. Please remove any objects that can interrupt ventilation around the product.
2. Please turn off the power of the product immediately if it fails to operate properly.
3. Carefully wire the product according to each product's specification.
4. Please be careful in preventing chemicals such as thinner, benzene, etc. in contact with the surface of the product.
5. Do not apply excessive force/impact to the product.
6. Failure to follow any of the instructions above may cause malfunction or damage to the product, fire, and electric shock.

Ordering Specifications

S125R	BZ	220	R
[Model number]	[Buzzer]	[Voltage]	[Color]
• S125R	• (Blank)	• 12-DC12V	R-Red
• S125U	• - No buzzer type	• 24-DC24V	A-Amber
	• BZ	• 110-AC110V	G-Green
	• - Built-in buzzer type	• 220-AC220V	B-Blue

Product Specifications

Model number	Voltage	Current	Bulb specifications			Certificate	Weight	Color
			Volts/Watts	Configuration	Part#			
S125R	DC12V	0.966A	12V10W	T16x35 15S	9	CE	0.40kg	R-Red A-Amber G-Green B-Blue
	DC24V	0.566A	24V10W		10			
	AC110V	0.130A	12V10W		9			
	AC220V	0.065A	12V10W		9			
S125U	DC12V	0.966A	12V10W	T16x35 15S	9	CE	0.41kg	R-Red A-Amber G-Green B-Blue
	DC24V	0.566A	24V10W		10			
	AC110V	0.130A	12V10W		9			
	AC220V	0.065A	12V10W		9			

※ CE compliant : DC12V/24V

- Protection rating : IP44
- Ambient operating temperature : -20°C to +50°C



Please scan the QR code for more detailed product information.

www.qlight.com

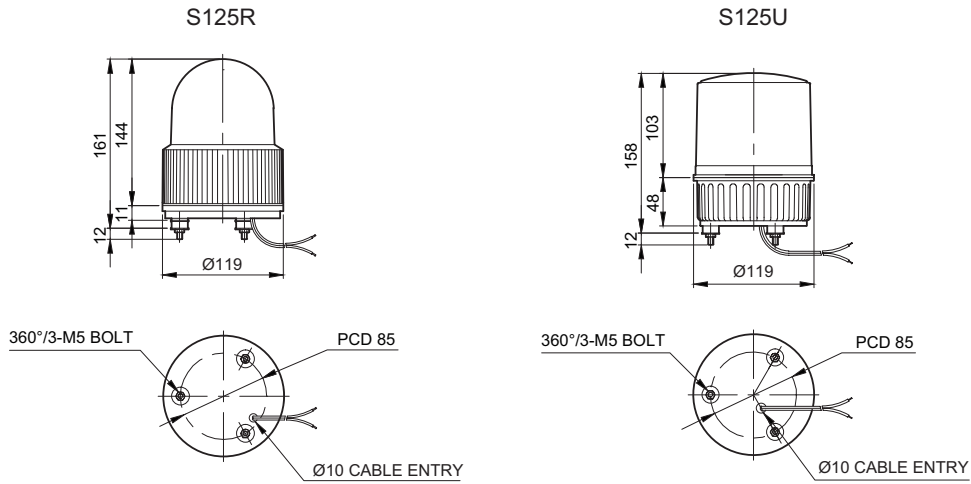

Wiring Instructions

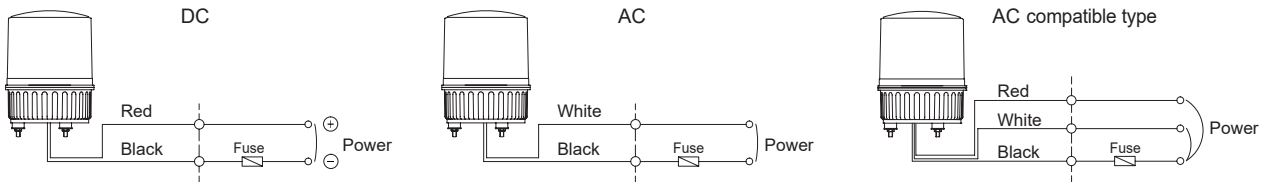

- External power line - UL1015 AWG18(0.75sq) × 2C 400mm
- For built-in buzzer type, there is a shared supply line for the buzzer and lighting element.
- AC compatible type shall be connected the black and white wires when using AC110V, and the black and red wires when using AC220V.

Parts Definition/ Installation/ Mounting Hole Specifications/ Bulb Replacement Instructions

Parts Definition/ Installation

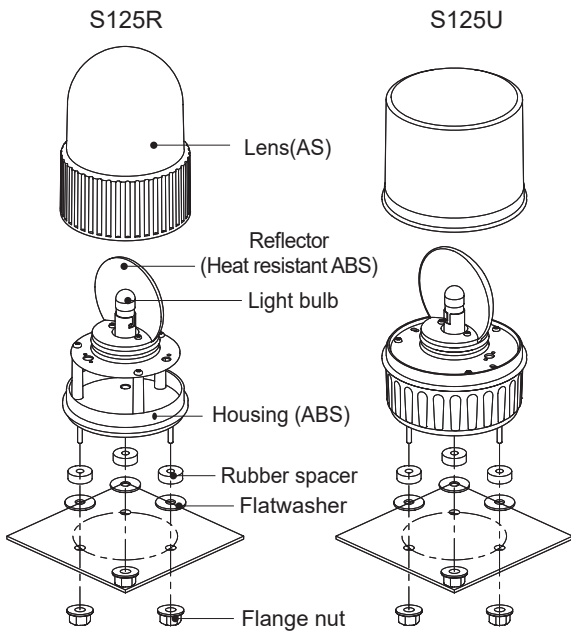

- First, remove the flange nuts from bolts and place the product through the mounting surface holes.
- Fasten the flange nuts on the opposite side of the mounting surface until the product is tightened securely.

Mounting Hole Specifications

- Machine holes on the mounting surface referring to the diagram below.

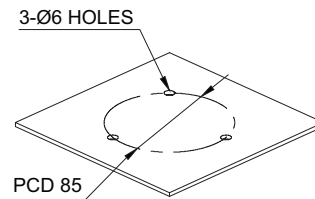

S125R/ S125U

Bulb Replacement Instructions

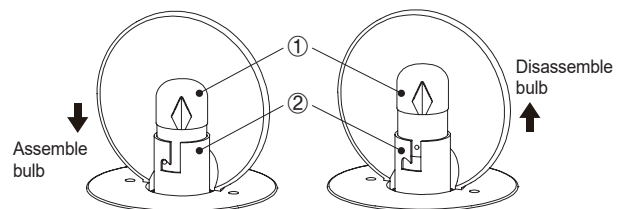

- Please wait at least 1 minute after turning off the power before replacing the bulb.
- In order to disassemble the bulb, please push down the bulb(①) lightly and screw it counterclockwise.
- In order to put the bulb in to the unit, please place the bulb(①) in the socket(②) and screw it clockwise while lightly pushing down the bulb.

Mounting Accessories (Sold Separately)

- Please refer to the dimensions below for installation of mounting brackets

		Dimensions	
S125R S125U	<p>Ø22 PCD85 PCD60-70 PCD50 360°/3- Ø5.5 HOLES 6-Ø5.5 HOLES 4-Ø5.5 HOLES Ø10 CABLE ENTRY</p> <p>115 65 26.5 70 90</p> <p>SWP125</p>	<p>Ø22 PCD85 PCD60-70 PCD50 360°/3- Ø5.5 HOLES 6-Ø5.5 HOLES 4-Ø5.5 HOLES Ø10 CABLE ENTRY</p> <p>117 69 26.5 70 94</p> <p>SWM125</p>	

Installation Environment and Protection Rating

- This product is designed for use with protection rating of IP44.
- If the product is installed in locations that subject it to excessive dust or water other than the designated IP protection rating indicated(IP44), it may cause malfunction or damage to the product.
- In case of outdoor applications, install the product in the upright position. Do not install the product horizontal or upside-down positions where water can potentially penetrate into the product and impact it's operation.
- For further information, please visit our website (www.qlight.com).

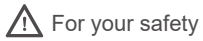

For your safety

Specification and dimensions listed in this catalogue subject to change without notice for product quality improvement.
The newest product information is available on our website.(www.qlight.com)
Please read the instruction manual attached to the product carefully before installation and use.

Qlight Co., Ltd. www.qlight.com | trade@qlight.com

Head Office | Suite #1510, STX-V Tower, 128 Gasan digital 1-ro, Geumcheon-gu, Seoul, Korea

Tel. +82-2-2679-6152(Toll free. +82-80-328-2222) Fax. +82-2-2679-6154

Factory | 185-25, Mukbang-ro, Sangdong-myeon, Gimhae-si, Gyeongsangnamdo, Korea Tel. +82-55-328-1111(Toll free. +82-80-328-1111)

Qlight OverSEAs Sales Dept | 704 Nakdong-daero, Sasang-gu, Busan, Korea(Eomgung-Dong) Tel : +82-51-620-4100

Qlight Public Relations & Marketing Team Office | 704 Nakdong-daero, Sasang-gu, Busan, Korea(Eomgung-Dong) Tel. +82-51-245-0017

Qlight USA, Inc. www.qlight.com www.qlightusa.com | sales@qlightusa.com

3003 North First Street, Suite #341, San Jose, CA 95134 USA Tel. +1-408-519-5740 Fax. +1-408-519-5739

SHANGHAI Qlight Electronic Co., Ltd. www.qlight.com www.qlightcn.com | qlightcn@qlight.com

China Factory/ Shanghai Sales Office | #19, Nanda Road, Baoshan Area, Shanghai, China Tel. +86-21-6651-7100 Fax. +86-21-6315-3929

China Factory Site 2 (Qidong) | #33, Haiyan Road, Qidong High-tech Industrial Development Zone, Qidong, Jiangsu Province, China

Tel +86-513-8384-9999 Fax +86-513-8384-9910

Qlightec

Innovation in Alarm & Signal

Product Operation Inquiry / Customer Support +82-51-620-4100

You can expect prompt service if you have exact information such as model name, symptom, telephone number and address.

※ ALL PRODUCT, PRODUCT SPECIFICATIONS AND DATA ARE SUBJECT TO CHANGE WITHOUT NOTICE TO IMPROVE RELIABILITY, FUNCTION OR DESIGN OR OTHERWISE.

Head office : Suite #1510, STX-V Tower, 128 Gasan digital 1-ro, Geumcheon-gu, Seoul, Korea (Postal Code : 08507)

Factory : 185-25, Mukbang-Ro, Sangdong-Myeon, Gimhae-Si, Gyeongsangnam-Do, Korea (Postal Code : 50805)

www.qlight.com

EN - S125R - 2205A