

Ø125mm Large-Sized Stackable Signal Light

S125TL

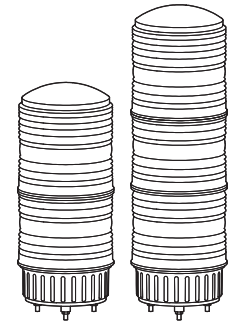

Thank you for purchasing Qlight's products. Please read this user manual carefully prior to installation and operation to ensure safe and correct use.

⚠ Precautions for Safety

Failure to follow the instructions below may cause a loss of life or serious physical injury.

1. During wiring or maintenance, please completely turn off the power of the product. (Failure to follow this may lead to an electric shock.)
2. Do not install the product in locations that subjects it to excessive dust or water other than the conditions designated by the IP protection ratings indicated for each product. (Failure to follow these instructions may cause a fire to the product, electric shock, physical injury, malfunction or damage to the product.)
3. Do not alter or repair this product. If maintenance or repair service is required, please contact your local Qlight contact point. (Failure to follow these instructions may lead to fire, electric shock, or product damage.)
4. Please apply the correct voltage to the product. (Failure to follow these instructions may lead to fire, electric shock, or product damage.)
5. When the product is applied to a condition that may impact lives or property, please make sure to have a double safety device. (Failure to follow this may cause damage to property, fire, electric shock and loss of life.)

⚠ Precautions for Correct Use

Failure to follow the proper instructions may cause damage to property, the product, or malfunction of the product that would void the warranty.

1. Please remove any objects that can interrupt ventilation around the product.
2. Please turn off the power of the product immediately if it fails to operate properly.
3. Carefully wire the product according to each product's specification.
4. Please be careful in preventing chemicals such as thinner, benzene, etc. in contact with the surface of the product.
5. Do not apply excessive force/impact to the product.
6. Failure to follow any of the instructions above may cause malfunction or damage to the product, fire, and electric shock.

Ordering Specifications

S125TL	3	24	RAG
[Model number]	[Layer]	[Voltage]	[Color]
• S125TL	• 1-1Layer • 2-2Layers • 3-3Layers	• 12/24 • DC12V-24V • 110 - AC110V • 220 - AC220V	R-Red A-Amber G-Green

Product Specifications

Model number	Layer	Voltage	Current	Certificate	Weight	Color
S125TL	1	DC12V -24V	Max. 0.300A	-	0.62kg	R-Red
		AC110V	0.080A		0.84kg	
		AC220V	0.040A			
	2	DC12V -24V	Max. 0.600A		0.88kg	R-Red G-Green
		AC110V	0.105A		1.11kg	
		AC220V	0.055A			
	3	DC12V -24V	Max. 0.900A		1.15kg	R-Red A-Amber
		AC110V	0.140A		1.38kg	
		AC220V	0.070A			

* Customized color arrangements available.

- Protection rating : IP44
- Ambient operating temperature : -30°C to +50°C



Please scan the QR code for more detailed product information.

www.qlight.com

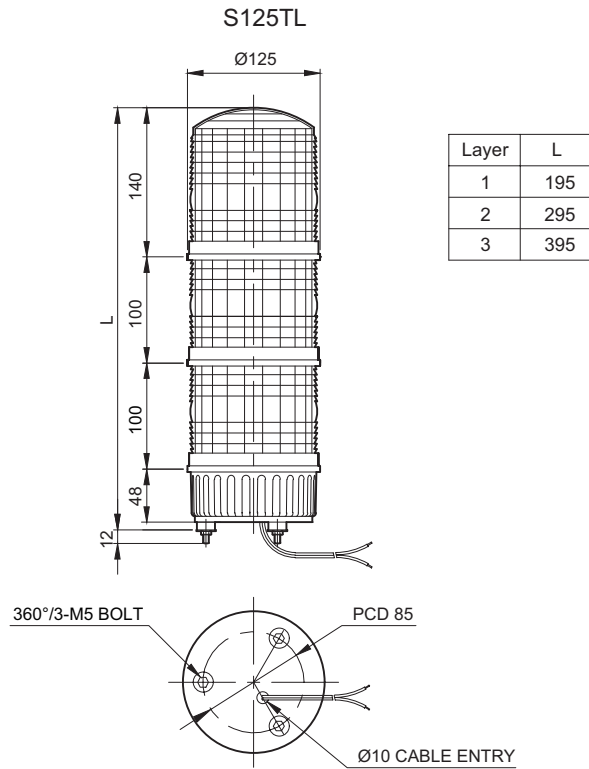

Wiring Instructions

- S125TL can be wired with either external contact or transistor.
- When using a transistor, please choose between the NPN transistor or PNP transistor which best matches the voltage and product type, then connect them correctly according to the wiring diagram below.
- S125TS which uses a xenon lamp can not be connected by using transistor. Please use an external contact.

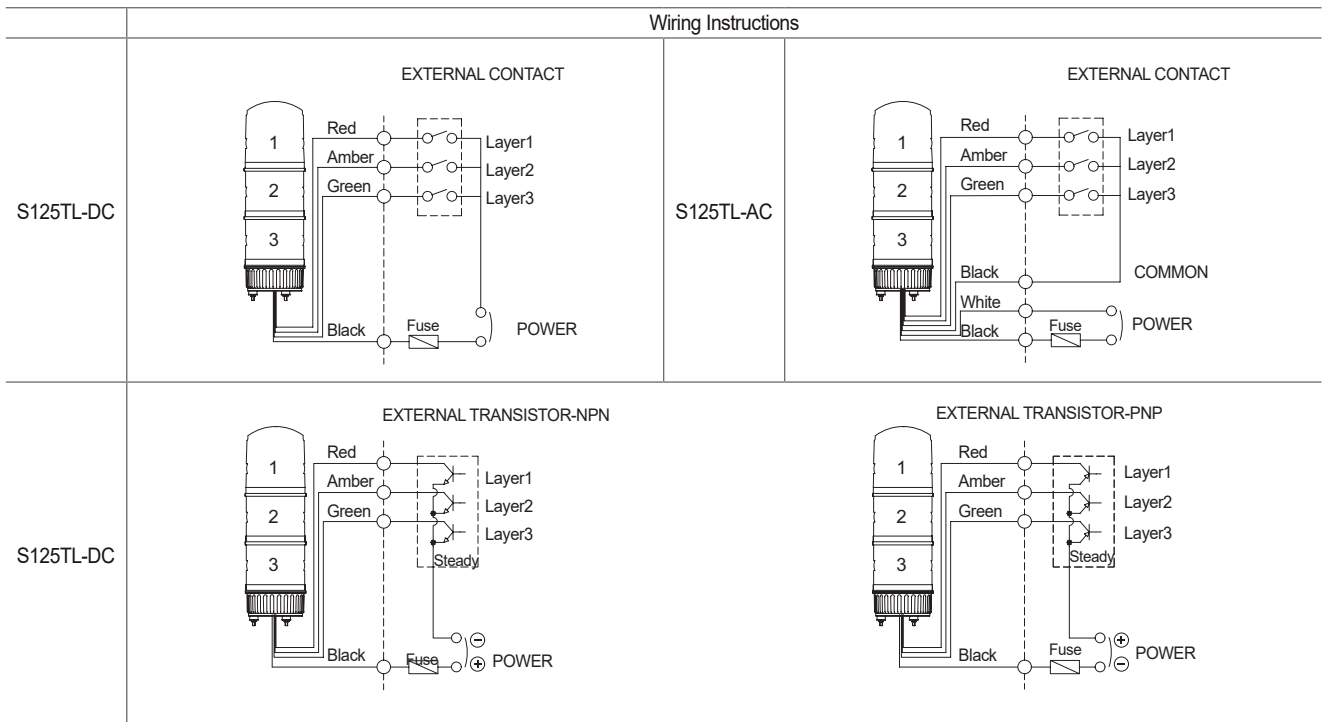

- External power line - UL1015 AWG18(0.75sq) × 2C 400mm
- External signal line - UL1007 AWG22(0.3sq) 400mm

Parts Definition/ Installation/ Light Function Selection

■ Parts Definition

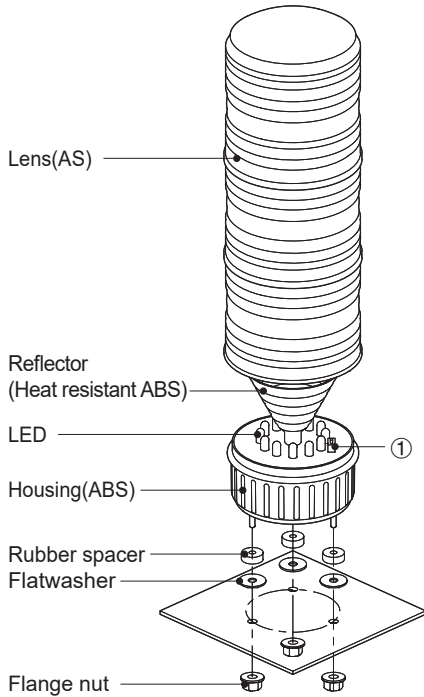

■ Light Function Selection

- Please refer to the chart below to use light function selection switch(①) located inside the product.

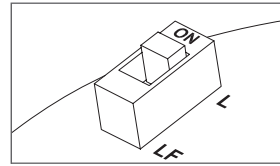

►L : Steady

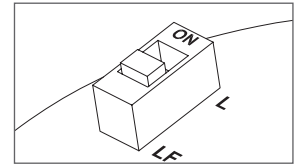

►LF : Flash

- Default function is set at steady LED. Select the desired function for your application during installation.

■ Installation

- remove the flange nuts from bolts and place the product through the mounting surface holes.
- Fasten the flange nuts on the opposite side of the mounting surface until the product is tightened securely.

Mounting Hole Specifications/ Xenon Bulb Replacement Instructions

■ Mounting Hole Specifications

- Machine holes on the mounting surface referring to the diagram below.

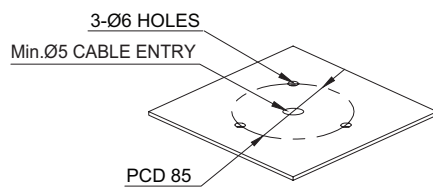

■ Xenon Bulb Replacement instructions(S125TS only)

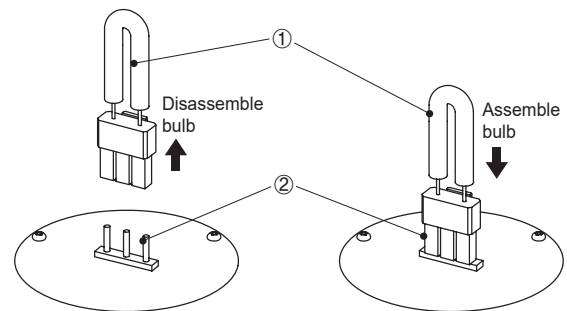

- Please wait at least 30 minutes after turning off the power before replacing the xenon bulb.
- Please pull out the entire xenon bulb structure ① to disassemble.
- For xenon bulb assembly, please ensure the connector portion of the xenon bulb structure matches the pin location②.

Installation Environment and Protection Rating

- This product is designed for use with protection rating of IP44.
- If the product is installed in locations that subject it to excessive dust or water other than the designated IP protection rating indicated(IP44), it may cause malfunction or damage to the product.
- In case of outdoor applications, install the product in the upright position. Do not install the product horizontal or upside-down positions where water can potentially penetrate into the product and impact it's operation.
- For further information, please visit our website (www.qlight.com).



For your safety

Specification and dimensions listed in this catalogue subject to change without notice for product quality improvement.
The newest product information is available on our website.(www.qlight.com)
Please read the instruction manual attached to the product carefully before installation and use.

Qlight Co., Ltd. www.qlight.com | trade@qlight.com

Head Office | Suite #1510, STX-V Tower, 128 Gasan digital 1-ro, Geumcheon-gu, Seoul, Korea

Tel. +82-2-2679-6152(Toll free. +82-80-328-2222) Fax. +82-2-2679-6154

Factory | 185-25, Mukbang-ro, Sangdong-myeon, Gimhae-si, Gyeongsangnamdo, Korea Tel. +82-55-328-1111(Toll free. +82-80-328-1111)

Qlight OverSEAs Sales Dept | 704 Nakdong-daero, Sasang-gu, Busan, Korea(Eomgung-Dong) Tel : +82-51-620-4100

Qlight Public Relations & Marketing Team Office | 704 Nakdong-daero, Sasang-gu, Busan, Korea(Eomgung-Dong) Tel. +82-51-245-0017

Qlight USA, Inc. www.qlight.com www.qlightusa.com | sales@qlightusa.com

3003 North First Street, Suite #341, San Jose, CA 95134 USA Tel. +1-408-519-5740 Fax. +1-408-519-5739

SHANGHAI Qlight Electronic Co., Ltd. www.qlight.com www.qlightcn.com | qlightcn@qlight.com

China Factory/ Shanghai Sales Office | #19, Nanda Road, Baoshan Area, Shanghai, China Tel. +86-21-6651-7100 Fax. +86-21-6315-3929

China Factory Site 2 (Qidong) | #33, Haiyan Road, Qidong High-tech Industrial Development Zone, Qidong, Jiangsu Province, China

Tel +86-513-8384-9999 Fax +86-513-8384-9910

Qlightec

Innovation in Alarm & Signal

Product Operation Inquiry / Customer Support +82-51-620-4100

You can expect prompt service if you have exact information such as model name, symptom, telephone number and address.

※ ALL PRODUCT, PRODUCT SPECIFICATIONS AND DATA ARE SUBJECT TO CHANGE WITHOUT NOTICE TO IMPROVE RELIABILITY, FUNCTION OR DESIGN OR OTHERWISE.

Head office : Suite #1510, STX-V Tower, 128 Gasan digital 1-ro, Geumcheon-gu, Seoul, Korea (Postal Code : 08507)

Factory : 185-25, Mukbang-Ro, Sangdong-Myeon, Gimhae-Si, Gyeongsangnam-Do, Korea (Postal Code : 50805)

www.qlight.com

EN - S125TL - 2106A