

Non Sparking Explosion Proof LED Tower Lights

STB45ML-Ex

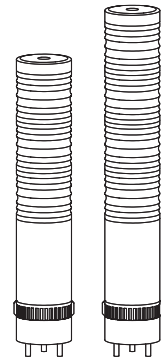

Thank you for purchasing Qlight's products. Please read this user manual carefully prior to installation and operation to ensure safe and correct use.

⚠ Safety Precautions for Explosion Proof Products

Please follow the instruction below to ensure safe and correct use of explosion proof products.

1. Explosion proof products should be managed according to explosion-proof regulations. Do not disassemble, assemble, alter or repair the product arbitrarily.
2. The temperature rating of the product is the temperature the product will experience at the applied rated voltage and ambient temperature indicated.
3. Use cable glands that satisfy the product's explosion proof grade and temperature grade.
4. Unused cable entries must be filled with material that meets the explosion proof grade and temperature rating.
5. Before installing the product, please make sure all cautions indicated on the labels, packaging, and operation manual of the product are fully understood.
6. Installation, maintenance and repair of the product must be performed by experts in the explosion proof field, or persons who have received relevant training.
7. For safety, the product should be installed and operated in environments that avoid high temperature and high pressure.
8. Please follow general safety precautions and avoid installing the product in locations that may generate excessive heat.
9. When installing the product in places where chemicals are located, please make sure that the environment does not have two or more incompatible chemicals mixed. For safety, please read the instruction manual carefully and be mindful of the chemical compositions where the product is used.
10. This product requires grounding.

⚠ Precaution for Safety

Failure to follow the instructions below may cause a loss of life or serious physical injury.

1. During wiring or maintenance, please completely turn off the power of the product. (Failure to follow this may lead to an electric shock.)
2. Do not install the product in locations that subjects it to excessive dust or water other than the conditions designated by the IP protection ratings indicated for each product. (Failure to follow these instructions may cause a fire to the product, electric shock, physical injury, malfunction or damage to the product.)
3. Do not alter or repair this product. If maintenance or repair service is required, please contact your local Qlight contact point. (Failure to follow these instructions may lead to fire, electric shock, or product damage.)
4. Please apply the correct voltage to the product. (Failure to follow these instructions may lead to fire, electric shock, or product damage.)
5. When the product is applied to a condition that may impact lives or property, please make sure to have a double safety device. (Failure to follow this may cause damage to property, fire, electric shock and loss of life.)

Failure to follow the proper instructions may cause damage to property, the product, or malfunction of the product that would void the warranty.

1. Please remove any objects that can interrupt ventilation around the product.
2. Please turn off the power of the product immediately if it fails to operate properly.
3. Carefully wire the product according to each product's specification.
4. Please be careful in preventing chemicals such as thinner, benzene, etc. in contact with the surface of the product.
5. Do not apply excessive force/impact to the product.
6. Static electricity may be generated by physical contact due to the surface characteristics of this product so please use a wet towel or anti-static cleaner to remove the foreign substances on the product.

Ordering Specifications

STB45ML3	Ex	12	RAG	STB45ML	3	12	RAG
[Model number]	[Explosion Proof]	[Voltage]	[Color]	[Model number]	[Layer]	[Voltage]	[Color]
• STB45ML2(2 layers)		• 12-DC12V	R-Red	• STB45ML	• 1-1Layer	• 12-DC12V	R-Red
• STB45ML3(3 layers)		• 24-DC24V	G-Green		• 2-2Layers	• 24-DC24V	G-Green
			R-Red		• 3-3Layers		A-Amber
			A-Amber		• 4-4Layers		B-Blue
			G-Green		• 5-5Layers		W-White



Please scan the QR code for more detailed product information.

www.qlight.com





Product Specifications

Explosion Proof Specifications

Model number	STB45ML-Ex
Range for operating voltage	DC 12V or 24V
Ex mark	KCs- Ex nR II T6 IP54 (Layer2-3) NEPSI, CCC -Ex nR IIC T6 Gc (Layer1-5) KCs - Ex nR II T4 IP54 (Customization, Layer1-5)
Ambient operating temperature	-20°C ≤ Tamb ≤ +40°C
Explosion proof Zone	Zone2
Protection rating	IP54

Zone definitions(Gas)	Zone 1	High risk gas/vapour
	Zone 2	Medium risk gas/vapour
Group definitions(Gas)	GROUP II A	Acetone, Petrol, Methanol, Propane, Toluene
	GROUP II B	Ethylene, City gas
	GROUP II C	Hydrogen, Acetylene, Carbon sulphide
Maximum surface temperature of electrical equipment	T1	450°C
	T2	300°C
	T3	200°C
	T4	135°C
	T5	100°C
	T6	85°C
Zone definitions(Dust)	Zone 21	High risk powder/dust
	Zone 22	Medium risk powder/dust
Group definitions(Dust)	GROUP II A	Ignitable fibers/flyings(more than 0.5mm)
	GROUP II B	Non-conductive dusts
	GROUP II C	Conductive dusts

General Product Specification

Model number	Layer	Voltage	Current	Certificates	Weight	Color
STB45ML-Ex	1	DC12V	0.055A		0.26kg	R-Red
		DC24V	0.070A		0.26kg	
	2	DC12V	0.075A		0.30kg	R-Red, G-Green
		DC24V	0.085A		0.30kg	
	3	DC12V	0.120A		0.34kg	R-Red, A-Amber, G-Green
		DC24V	0.095A		0.34kg	
	4	DC12V	0.160A		0.38kg	R-Red, A-Amber, G-Green, B-Blue
		DC24V	0.110A		0.38kg	
	5	DC12V	0.200A		0.42kg	R-Red, A-Amber, G-Green, B-Blue, W-White
		DC24V	0.120A		0.42kg	

Dimensions

(Units : mm)

STB45ML-Ex

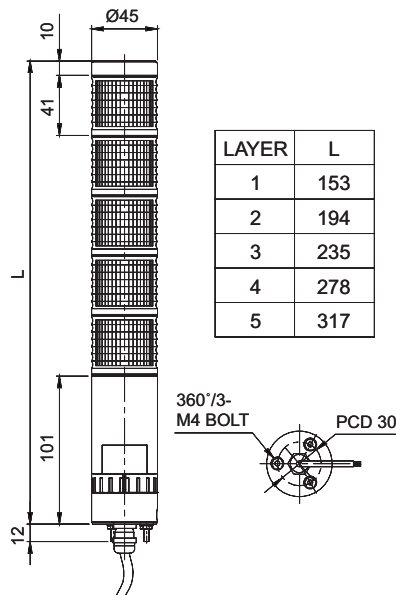

Wiring Instructions

- STB45ML-Ex can be wired by using both external contact and transistor.
- In case of wiring by transistor, please make sure if it is NPN type or PNP type. Please carefully follow wiring instruction below.

STB45ML-Ex-DC

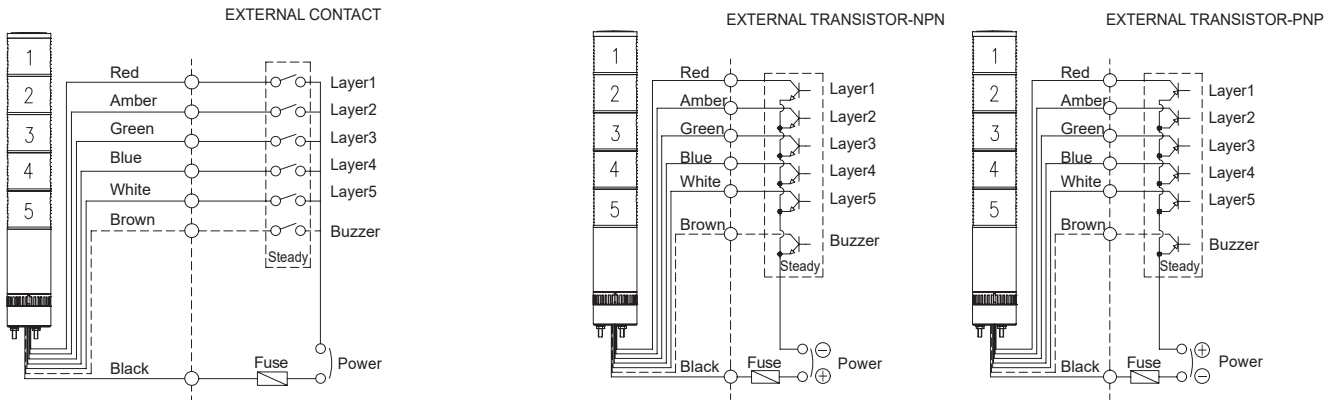

- External power line/ external signal line - UL2464 AWG22(0.3sq) 400mm
- This product can be wired regardless of polarity.

Parts Definition/ Installation

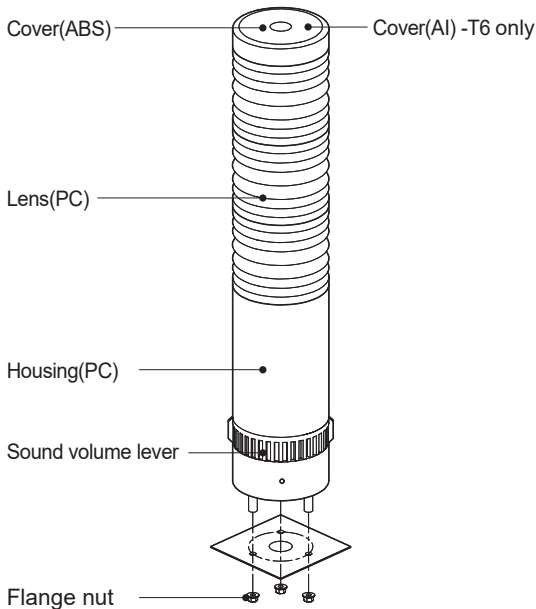

- First, remove the flange nuts from bolts and place the product through the mounting surface holes.
- Fasten the flange nuts on the opposite side of the mounting surface until the product is tightened securely.

Mounting Hole Specifications

- Machine holes on the mounting surface referring to the diagram below.

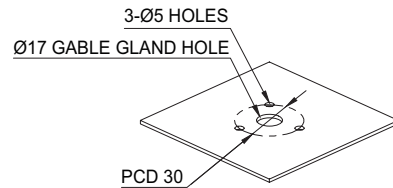

Grounding Instructions

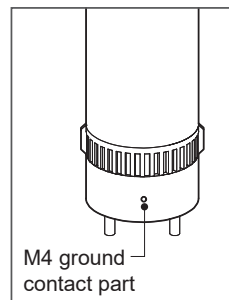

- Please use an M4 bolt at the location marked in the diagram above to ground the product.
- When connecting the grounding cable, please use a ring terminal.
- Please use a ring terminal made of C5212 material as it has the same electrical properties of the conductor.
- Please use a grounding cable with a diameter greater than 4mm.

Buzzer Sound Volume Adjustment Instructions

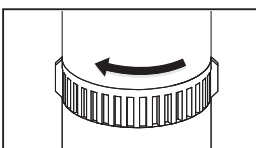

Buzzer volume is reduced by sliding the volume control lever to the left as shown in the diagram to the left.
(Min. 65dB/m)

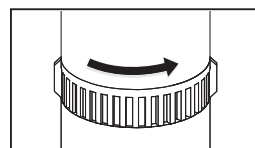

Raise/ Increase the buzzer volume by sliding the control lever to the right as shown in the diagram to the left.
(Max. 83dB/m)

Installation Environment and Protection Rating

- This product is designed to be explosion proof.
- Please make sure to use the product in an environment that meets the specified explosion proof rating and regulations.
- For further information, please visit our website (www.qlight.com).



For your safety

Specification and dimensions listed in this catalogue subject to change without notice for product quality improvement.
The newest product information is available on our website.(www.qlight.com)
Please read the instruction manual attached to the product carefully before installation and use.

Qlight Co., Ltd. www.qlight.com | trade@qlight.com

Head Office | Suite #1510, STX-V Tower, 128 Gasan digital 1-ro, Geumcheon-gu, Seoul, Korea

Tel. +82-2-2679-6152(Toll free. +82-80-328-2222) Fax. +82-2-2679-6154

Factory | 185-25, Mukbang-ro, Sangdong-myeon, Gimhae-si, Gyeongsangnamdo, Korea Tel. +82-55-328-1111(Toll free. +82-80-328-1111)

Qlight OverSEAs Sales Dept | 704 Nakdong-daero, Sasang-gu, Busan, Korea(Eomgung-Dong) Tel : +82-51-620-4100

Qlight Public Relations & Marketing Team Office | 704 Nakdong-daero, Sasang-gu, Busan, Korea(Eomgung-Dong) Tel. +82-51-245-0017

Qlight USA, Inc. www.qlight.com www.qlightusa.com | sales@qlightusa.com

3003 North First Street, Suite #341, San Jose, CA 95134 USA Tel. +1-408-519-5740 Fax. +1-408-519-5739

SHANGHAI Qlight Electronic Co., Ltd. www.qlight.com www.qlightcn.com | qlightcn@qlight.com

China Factory/ Shanghai Sales Office | #19, Nanda Road, Baoshan Area, Shanghai, China Tel. +86-21-6651-7100 Fax. +86-21-6315-3929

China Factory Site 2 (Qidong) | #33, Haiyan Road, Qidong High-tech Industrial Development Zone, Qidong, Jiangsu Province, China

Tel +86-513-8384-9999 Fax +86-513-8384-9910

Qlightec

Innovation in Alarm & Signal

Product Operation Inquiry / Customer Support +82-51-620-4100

You can expect prompt service if you have exact information such as model name, symptom, telephone number and address.

※ ALL PRODUCT, PRODUCT SPECIFICATIONS AND DATA ARE SUBJECT TO CHANGE WITHOUT NOTICE TO IMPROVE

RELIABILITY, FUNCTION OR DESIGN OR OTHERWISE.

Head office : Suite #1510, STX-V Tower, 128 Gasan digital 1-ro, Geumcheon-gu, Seoul, Korea (Postal Code : 08507)

Factory : 185-25, Mukbang-Ro, Sangdong-Myeon, Gimhae-Si, Gyeongsangnam-Do, Korea (Postal Code : 50805)

www.qlight.com

EN - STB45ML-Ex - 2309A