

Industrial LED beacon

ET64MCL Series

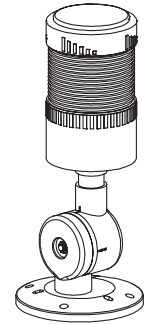
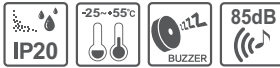

Thank you for purchasing Qlight's products. Please read this user manual carefully prior to installation and operation to ensure safe and correct use.

⚠ Precautions for Safety

Failure to follow the instructions below may cause a loss of life or serious physical injury.

1. During wiring or maintenance, please completely turn off the power of the product. (Failure to follow this may lead to an electric shock.)
2. Do not install the product in locations that subjects it to excessive dust or water other than the conditions designated by the IP protection ratings indicated for each product. (Failure to follow these instructions may cause a fire to the product, electric shock, physical injury, malfunction or damage to the product.)
3. Do not alter or repair this product. If maintenance or repair service is required, please contact your local Qlight contact point. (Failure to follow these instructions may lead to fire, electric shock, or product damage.)
4. Please apply the correct voltage to the product. (Failure to follow these instructions may lead to fire, electric shock, or product damage.)
5. When the product is applied to a condition that may impact lives or property, please make sure to have a double safety device. (Failure to follow this may cause damage to property, fire, electric shock and loss of life.)

⚠ Precautions for Correct Use

Failure to follow the proper instructions may cause damage to property, the product, or malfunction of the product that would void the warranty.

1. Please remove any objects that can interrupt ventilation around the product.
2. Please turn off the power of the product immediately if it fails to operate properly.
3. Carefully wire the product according to each product's specification.
4. Please be careful in preventing chemicals such as thinner, benzene, etc. in contact with the surface of the product.
5. Do not apply excessive force/impact to the product.
6. Failure to follow any of the instructions above may cause malfunction or damage to the product, fire, and electric shock.

Ordering Specifications

ET64MCL	-	24	-	R
[Model number]		[Voltage]		[Color]
• ET64MCL		• 24 - DC24V		R-Red
• ET64MCL-BZ				A-Amber
• ET64MCLF				G-Green
• ET64MCLF-BZ				

Product Specifications

Model number	Layers	Voltage	Current	Certificate	Weight	Color
ET64MCL Steady	1	DC24V	0.067A	CE	0.23Kg	R-Red A-Amber G-Green
ET64MCL-BZ Steady w/built-in buzzer						
ET64MCLF Flashing						
ET64MCLF-BZ Flashing w/built-in buzzer						

Dimensions

(Units : mm)

- ET64MCL, ET64MCL-BZ, ET64MCLF, ET64MCLF-BZ

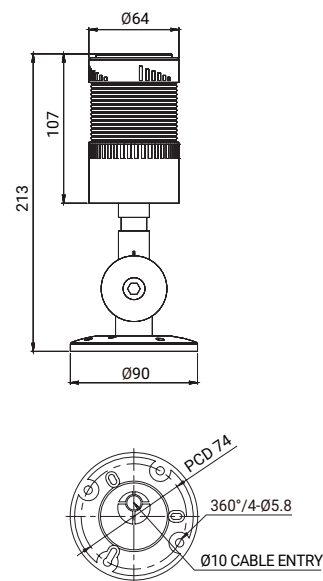

Please scan the QR code for more detailed product information.

www.qlight.com

Wiring Instructions

- ET64MCL series can be wired by using both external contact and transistor.
- Wiring to transistor, use the PNP transistor. Please wire properly based on wiring instructions.

ET64MCL, ET64MCL-BZ, ET64MCLF, ET64MCLF-BZ

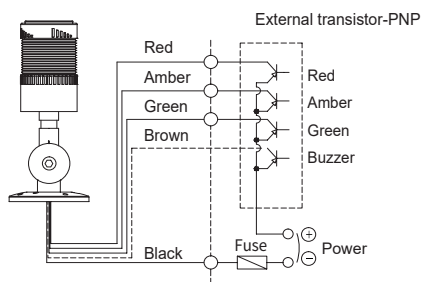
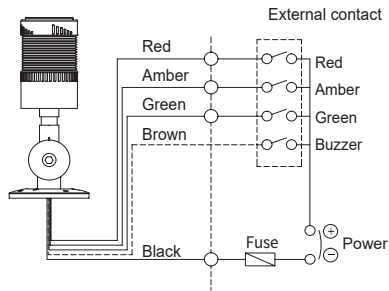

- External power/ signal line - UL1007 AWG22(0.3sq) 400mm

※ ET64MCL, ET64MCL-BZ: Steady
ET64MCLF, ET64MCLF-BZ: Flashing

Installation Environment and Protection Rating

- This product is designed for indoor use with protection rating of IP20.
- If the product is installed in locations that subject it to excessive dust or water other than the designated IP protection rating indicated, it may cause malfunction or damage to the product.
- For further information, please visit our website (www.qlight.com).

Parts Definition/ Installation

ET64MCL, ET64MCL-BZ, ET64MCLF, ET64MCLF-BZ

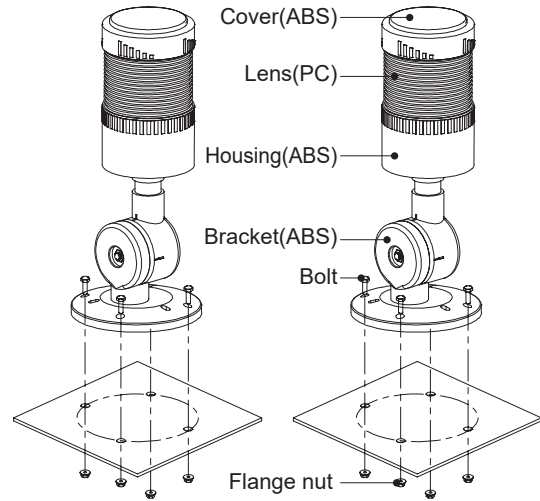

- Please disassemble the M5 bolts placed in mounting bolts and place the bracket on to desired mounting surface.
- Tighten the flange nuts from the opposite side of the mounting surface.

Mounting Hole Specifications

- Machine holes on the mounting surface referring to the diagram below.

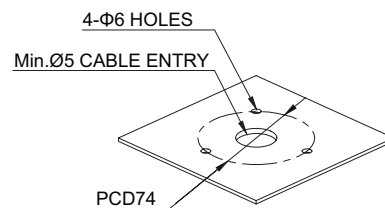

Qlightec
Innovation in Alarm & Signal

Product Operation Inquiry / Customer Support +82-51-620-4100

You can expect prompt service if you have exact information such as model name, symptom, telephone number and address.

※ ALL PRODUCT, PRODUCT SPECIFICATIONS AND DATA ARE SUBJECT TO CHANGE WITHOUT NOTICE TO IMPROVE RELIABILITY, FUNCTION OR DESIGN OR OTHERWISE.

www.qlight.com

EN - ET64MCL - 2305A