



PRECISION MEETS QUALITY

INTELLIGENT MEASUREMENT SENSORS: FOR QUALITY
IN EVERY PROCESS STEP.

Our solution for measurement sensors.

SICK
Sensor Intelligence.

PRECISION MEETS QUALITY

With intelligent measurement technology, SICK offers the solution to any challenge which demands maximum accuracy and quality, developed by the experts who shed light on the industry: A pioneering spirit founded on our years of experience and our own innovations in optical sensor technology. We ensure efficient processes while also fulfilling the demands of complex measuring tasks – regardless of surface, diameter, depth, or width, and regardless of whether a product is to be positioned or measured. This is how we ensure that your products are as perfect as you want them to be.

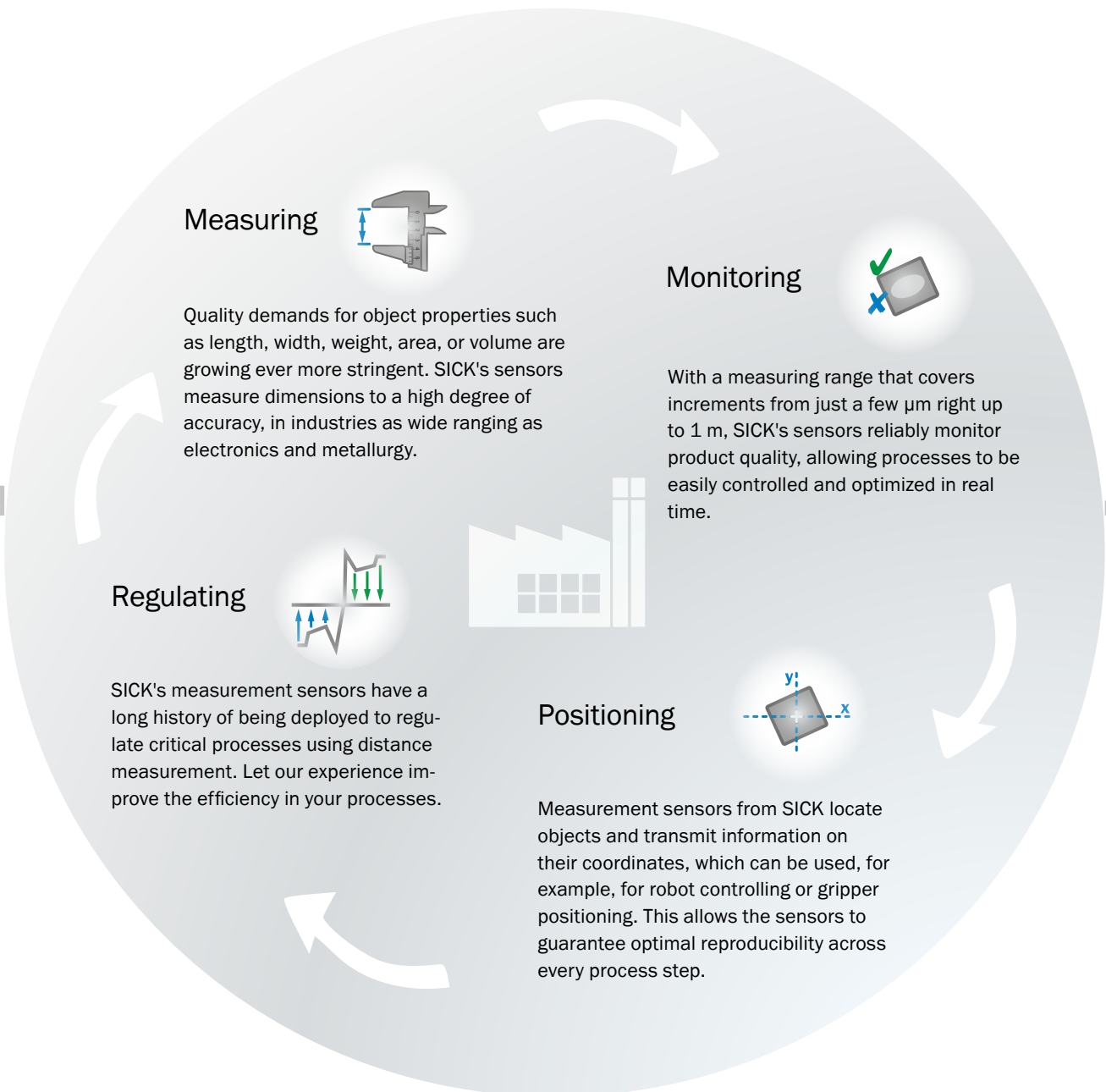



PRECISION IN EACH COMPONENT AND EACH PROCESS STEP

Perfect quality can only be guaranteed when each measurement and process step is controlled. Thanks to its wide range of optical sensors, SICK's intelligent measurement technology can offer highly accurate solutions for measuring even the smallest objects, setting new standards in measurement accuracy through the use of numerous technologies, such as 1D and 2D laser triangulation and chromatic confocal method. This plays an important role in a whole host of different industries – particularly those with a strong emphasis on the measuring, regulation, positioning, or monitoring of products and processes. Moreover, SICK's measurement technology supports quality assurance processes and delivers cost saving benefits.

DAY IN, DAY OUT.
100% QUALITY.



Displacement measurement sensors detect:

- Depth and width
- Height and step
- Position
- External and internal diameters
- Profile measurements
- Planarity
- Gap and distance measurements
- Axial runout

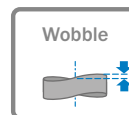
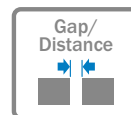
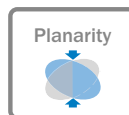
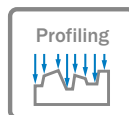
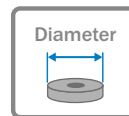
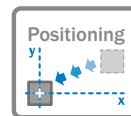
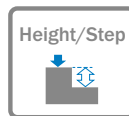
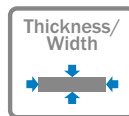

Whether stand-alone or as part of a system, SICK's intelligent measurement technology can supply the perfect solutions for the demands of your industry.

ELECTRONICS

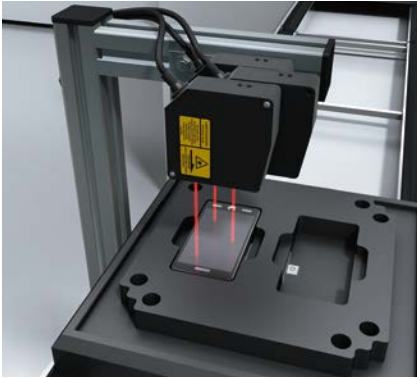

OD Precision – Measuring the correct position of device assemblies

Checking that device assemblies are installed in the correct positions can prevent connection errors. This is incredibly important in applications such as smartphone displays. By making use of three OD Precision sensors, connection errors of this nature can be identified with micrometer-level accuracy.

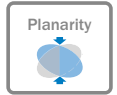

→ www.sick.com/OD_Precision

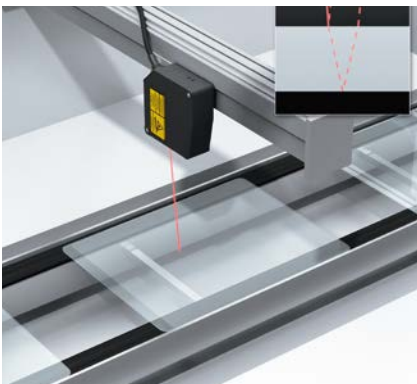

OD Precision – Glass thickness measurement with just one sensor head

Determining the thickness of transparent glass is crucial for achieving a high-quality display. Thanks to the triangulation technology of the OD Precision, these thicknesses can be measured with high accuracy using just a single sensor head. The laser beam of the sensor is reflected on both sides of the material and detected by the integrated receiver.

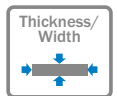

→ www.sick.com/OD_Precision

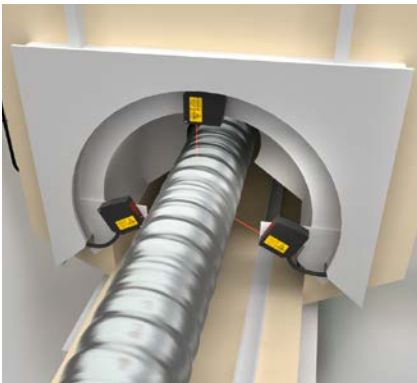

OD Precision – Silicon ingot diameter measurement

Optimizing wafer yield from a valuable and fragile silicon ingot is not an easy task. Step one is accurately sizing an irregular and glossy object. Choose an OD Precision measurement sensor, set in differential/mirror mode. Surface variations don't require time consuming recalibration.

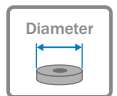

→ www.sick.com/OD_Precision

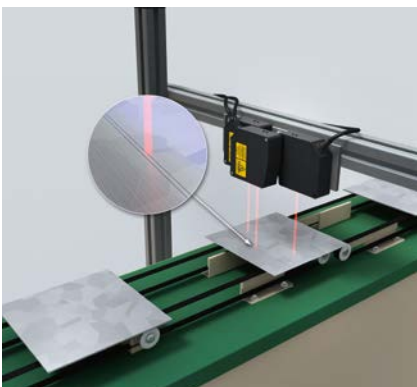

OD Precision – Saw mark inspection on solar wafers

The risk of breakage of wafers is eliminated by measuring the depth of saw marks. The displacement measurement sensors guarantee high wafer quality even during the manufacturing process.

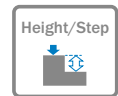

→ www.sick.com/OD_Precision

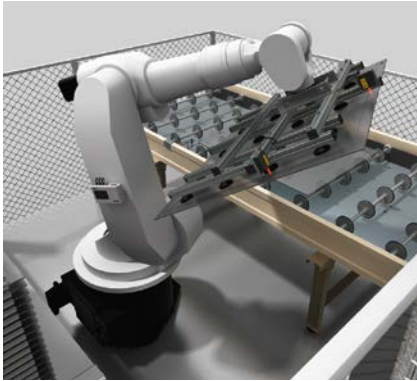

OD Precision – Gripper control on robots in solar applications

Handling of fragile glass substrates requires communicating exact position to the controls. The OD Precision displacement measurement sensors can use up to three independent read heads, each with different characteristics. No special calibration is required, and customers are free to choose the appropriate head.

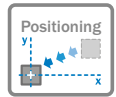

→ www.sick.com/OD_Precision



OD Mini – Precise height monitoring of printed circuit board devices

The heights of devices on printed circuit boards are often determined while they are moving. The OD Mini measurement sensor is an ideal tool for this job. Not only does it detect whether devices are absent or have been placed incorrectly, but it also offers a range of sensing distances, opening up more flexible possibilities for machine design.

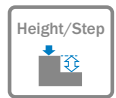

→ www.sick.com/OD_Mini



OD Mini – Inspection of components and layers

With its extremely small size and light weight, the OD Mini measurement sensor opens up entirely new application possibilities. Mounted on the robot assembly arm or XY portal, it measures distances of up to 250 mm at resolutions in the μm range. It can detect missing parts or measure substrate coatings.

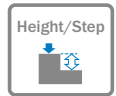

→ www.sick.com/OD_Mini



Profiler2 – Checking the profile of applied seals

If seals are applied incorrectly or in the wrong positions during the final production of electronic devices, significant defects can arise in the devices as a result. The Profiler2 makes it possible to create comprehensive and non-contact 2D profile analysis of sealing and glue beads during the manufacturing process, ensuring the quality of seals.



→ www.sick.com/Profiler

ELECTRONICS

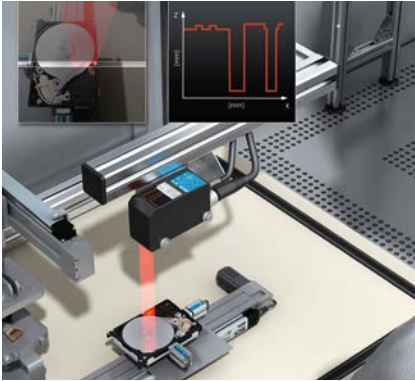

Profiler2 – Check of lengths-/ height geometries in the regular process

The Profiler2 configurable sensor performs highly accurate measurements on the x and z axes. Up to four areas can be analyzed at the same time with one measurement. One of the ten integrated measurement functions can be selected to perform this analysis. While the integrated CMOS receiver unit guarantees precise measuring, the supplied software makes commissioning simple and provides exceptional visualization of the measurement process.

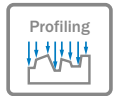

→ www.sick.com/Profiler

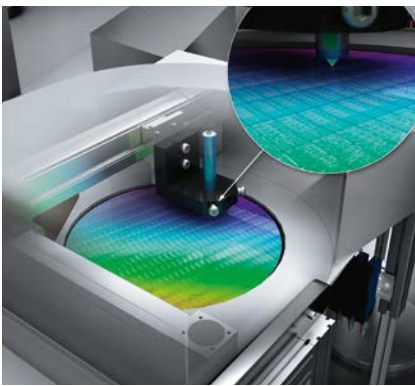

OC Sharp – Measuring layer thicknesses on semiconductor wafers

The layers for electronic circuits on semiconductor wafers are applied at micrometer level. The OC Sharp is ideally suited to tasks involving this. With nanometer-level resolution, this measurement sensor can measure layers of semiconductor wafers with exceptional precision from a thickness of as little as 3 µm.

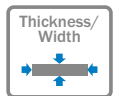

→ www.sick.com/OC_Sharp

AUTOMOTIVE AND PART SUPPLIERS



OD Precision – Regulating the calendaring process

To regulate the calendaring process, high-accuracy, OD Precision sensors are arranged in pairs to carry out thickness measurements at three positions on the conveyor belt using a differential method. Deviations in thickness of less than 1 µm can therefore be detected reliably in order to ensure consistent quality and, therefore, reliability in tire manufacturing.

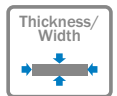

→ www.sick.com/OD_Precision



OD Precision – Precise component measurement

Quality control of the piston rod is carried out directly at the place-set area. Two OD Precision determine the difference between set and actual values of the connecting rod and signal deviations in height. Digital signals handle system integration.



→ www.sick.com/OD_Precision



OD Mini – Robot guidance for installation of windshields

The robot takes the windshield from the turntable. The robot then travels to the approximate position over the windshield cutout in the body. It moves its gripper over the installation point until the OD Mini displacement measurement sensors register the exact distance. The windshield is then inserted precisely.

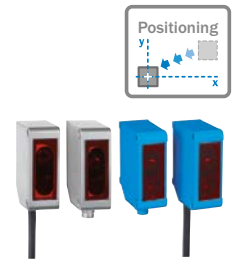

→ www.sick.com/OD_Mini

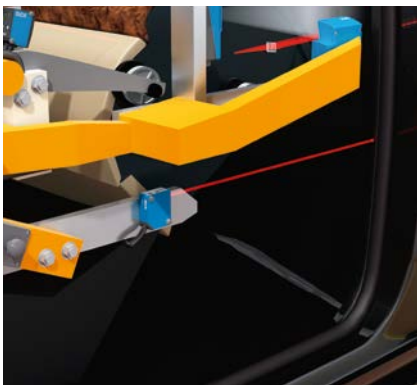

OD Value – Precise distance measurement for robot guidance

When installing the dashboard, the OD Value displacement measurement sensor positions the robot precisely. Simple sensor teach-in makes commissioning faster and more cost-effective. The compact, stand-alone design saves space and reduces the need for cabling.



→ www.sick.com/OD_Value

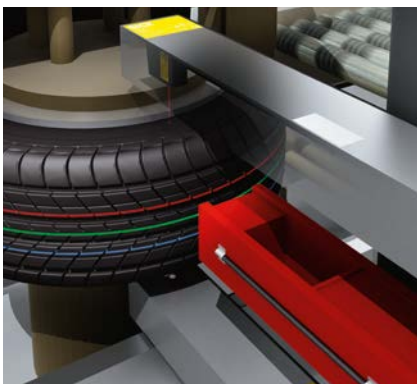

OD Max – Inspecting the tire geometry

Stringent quality requirements apply to tire production. These include a final check of the tire geometry. Displacement measurement sensors are used to check for radial run-out, bulges, depressions and other inaccuracies while the tire is rotating.

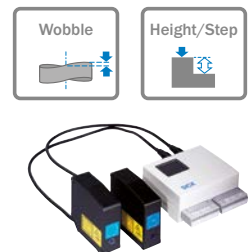

→ www.sick.com/OD_Max

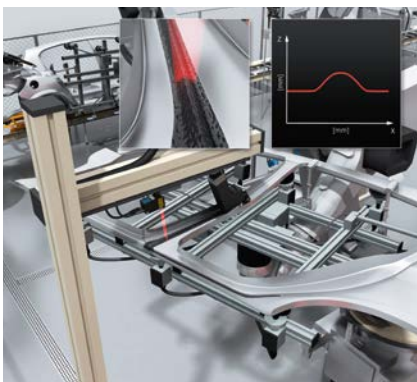

Profiler2 – High precise glue inspection during process

The inline quality inspection for glue – from applying the glue to the glue quantity check and up to checking for bubbles – is one of the main tasks in the gluing process. The Profiler 2 enables reliable implementation of sophisticated 2D contour checks.



→ www.sick.com/Profiler

AUTOMOTIVE AND PART SUPPLIERS

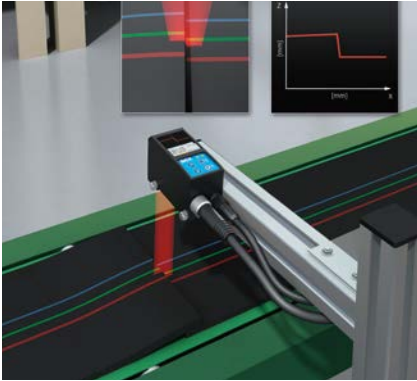

Profiler2 – Monitoring material thickness in the tire industry

Thanks to the Profiler2 sensor, effective monitoring of material thickness and material overlap in various belts and sheets is ensured directly in the production line. In addition, production workflows can be adjusted quickly and easily, since the sensor measures the thickness immediately after material processing and regulates the process accordingly.



→ www.sick.com/Profiler

MACHINE TOOLS



OD Precision – Non-contact double sheet monitoring

Two OD Precision displacement measurement sensors determine the thickness of the sheet with an accuracy of $\pm 10 \mu\text{m}$. This solution reliably detects double sheets and sheet thickness. The non-contact measurement method improves the cycle time and, consequently, the efficiency of the machine. An evaluation unit calculates the measuring signals and transfers the results to the control.

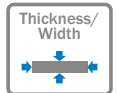

→ www.sick.com/OD_Precision



OD Max – Height positioning and collision awareness at the cutting head

During machining, heat and tension can lead to uneven sheets. An OD Max displacement measurement sensor continuously checks the distance between the cutting head and the sheet panels on the machining table to avoid collisions.



→ www.sick.com/OD_Max

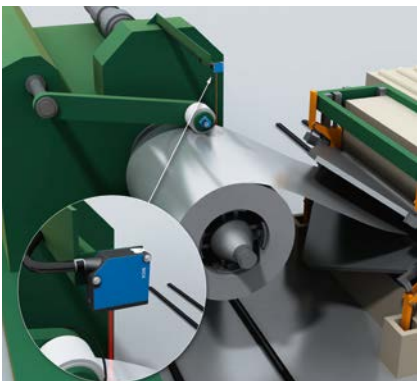

DT20 Hi – Sheet coil uncoiling

To ensure a constant feed of material, the uncoiling speed of the sheet coil must be regulated. The DT20 Hi measurement sensor continuously measures the radius of the sheet coil throughout the entire unwinding process.

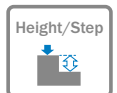

→ www.sick.com/DT20_Hi

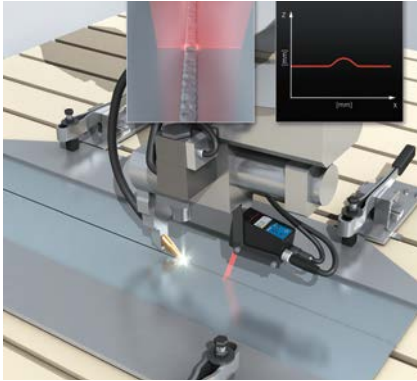

Profiler2 – Measuring and monitoring weld seams

The Profiler2 measures the shape of the weld seam immediately after welding. In addition, the Profiler2 – a 2D laser profile sensor – can perform various functions such as measuring and analyzing the height and width of a weld seam, as well as the angles of the welded elements.



→ www.sick.com/Profiler

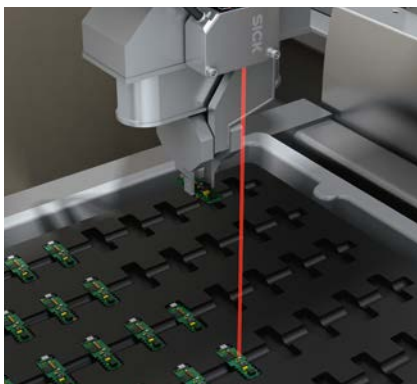

OD Mini – Height monitoring of tray stacks

A gripper arm removes the uppermost tray from a tray stack and lifts it to an intermediate position, following which the PCBs in the tray are led to an assembly line. To ensure that the gripper arm is carrying the tray at the right points, the OD Mini measurement sensor detects the height of the tray stack using distance measurement and relays the measured data to the pallet handling machine's control unit.



→ www.sick.com/OD_Mini

RUBBER AND PLASTICS



OC Sharp – Thickness measurement of transparent films

The OC Sharp measurement sensor, equipped with chromatic confocal technology, measures the thicknesses of transparent plastic films or their individual layers with just one sensor head – with high precision and without any contact.



→ www.sick.com/OC_Sharp

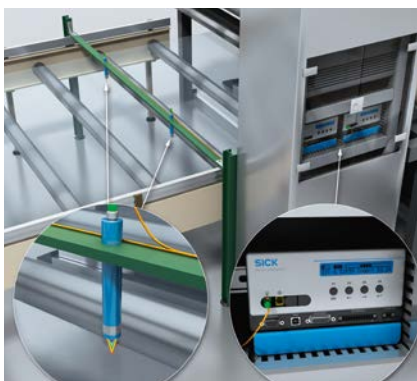

OC Sharp – High-precision measurement of film thickness

Correct film thickness is a key feature of high-quality films. Even during ongoing production, the OC Sharp detects changes in the film thickness produced by the eccentricity of the rollers, folds, or fluctuations in film tension. Just a single OC Sharp is enough to measure layers of transparent and thin films with high accuracy.



→ www.sick.com/OC_Sharp

PRINT



OD Value – Positioning the paper stack

The OD Value measurement sensor ensures precise side positioning of the stack at the feeder. This guarantees accurate positioning when removing the paper sheets.

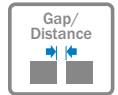

→ www.sick.com/OD_Value

TRAFFIC

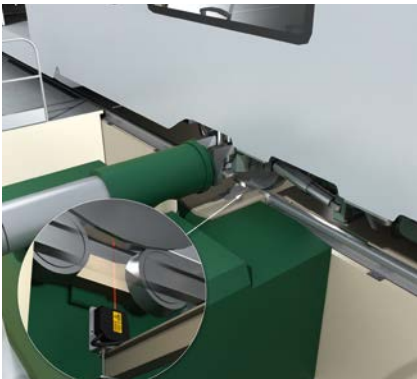

OD Precision – Measuring train wheels and rail profiles

High-speed trains and strict international regulations have made requirements for train wheels and rails all the more stringent. The OD Precision makes it extremely easy to comply with these requirements by measuring train wheel and rail profiles with micrometer-level accuracy. As a result, this sensor ensures that train wheels have exactly the right settings and helps improve track safety.



→ www.sick.com/OD_Precision

CONSUMER GOODS



OC Sharp – Non-contact measurement of glass containers

In the production of glass containers, high speeds and large temperature differences are the norm. The OC Sharp measurement sensor is ideal for overcoming these challenges. Without any contact, it measures the wall thickness and roundness of the glass. It works using chromatic confocal technology, thereby consistently delivering the most accurate measured values.



→ www.sick.com/OC_Sharp



OD Mini – Quality control of blister packaging

With its extremely small size and light weight, the OD Mini measurement sensor opens up entirely new applications for production processes. In the monitoring of pressed blister packaging, it allows distances up to 250 mm to be measured in μm increments, enabling the sensor to precisely detect incorrectly pressed packaging. Thanks to its display, the OD Mini can be commissioned quickly and easily.



→ www.sick.com/OD_Mini

WOOD

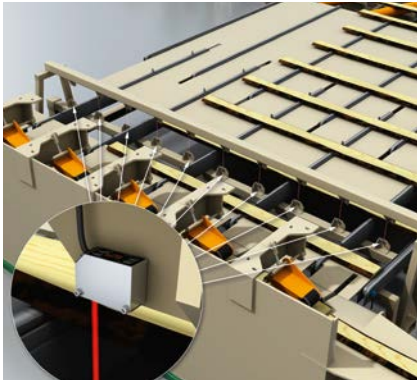

OD Mini – Wane measurement

An exact profile of the board is created by means of two highly precise OD Mini displacement measurement sensors mounted opposite from each other. The vision integrator uses the data from the measurement and interpolates the differential between the profiles for optimizing the board, which is then trimmed in the saw.

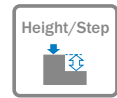

→ www.sick.com/OD_Mini

PHARMA AND COSMETICS

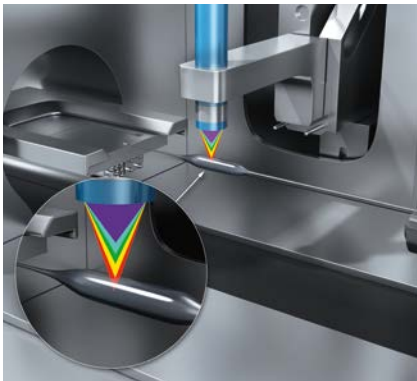

OC Sharp – Thickness measurement when stretching out a balloon catheter

The thickness distribution of a balloon catheter while it is being stretched out provides important information that helps ensure the correct wall thickness. Working with high precision and without any contact, the OC Sharp confocal measurement sensor measures the thickness at every position of the catheter's balloon while it is being stretched out. Moreover, the measuring object remains untouched during this process.

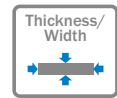

→ www.sick.com/OC_Sharp

You need 3D solutions? SICK offers a broad portfolio of 3D vision sensors.

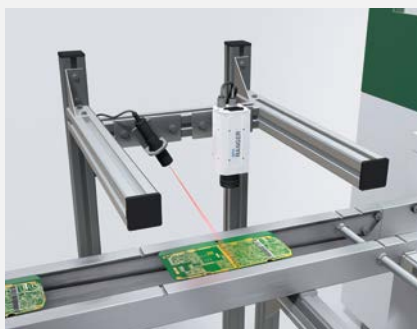
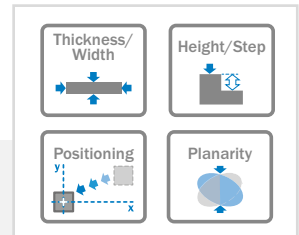

Ranger – Fast 3D and MultiScan for advanced industrial solutions

Ranger extracts the true 3D shape of an object with high data quality at unsurpassed speed. It is used in applications such as measuring object height and volume, shape defect detection, quality grading and size sorting. With its unique MultiScan functionality, the object's shape, contrast, color, and scatter can be measured at the same time, enabling reliable inspection results and cost-efficient solutions; one Ranger performs it all!



→ www.sick.com/Ranger



TriSpector1000 – Intuitive 3D inspection

The TriSpector1000 is a stand-alone configurable sensor for cost-efficient 3D inspections. No matter what the shape, color or orientation of the product, the sensor is up to the challenge. Now content, completeness and emptiness can be verified in all dimensions. It is perfectly suited for solving quality control applications in the consumer goods and packaging industry. Thanks to its intuitive user interface, the TriSpector1000 ensures easy commissioning and operation.



→ www.sick.com/TriSpector1000

SICK AT A GLANCE

SICK is a leading manufacturer of intelligent sensors and sensor solutions for industrial applications. With almost 7,000 employees and over 50 subsidiaries and equity investments as well as numerous representative offices worldwide, we are always close to our customers. A unique range of products and services creates the perfect basis for controlling processes securely and efficiently, protecting individuals from accidents and preventing damage to the environment.

We have extensive experience in various industries and understand their processes and requirements. With intelligent sensors, we can deliver exactly what our customers need. In application centers in Europe, Asia and North America, system solutions are tested and optimized in accordance with customer specifications. All this makes us a reliable supplier and development partner.

Comprehensive services round out our offering: SICK LifeTime Services provide support throughout the machine life cycle and ensure safety and productivity.

For us, that is “Sensor Intelligence.”

Worldwide presence:

Australia, Austria, Belgium, Brazil, Canada, Chile, China, Czech Republic, Denmark, Finland, France, Germany, Great Britain, Hungary, India, Israel, Italy, Japan, Malaysia, Mexico, Netherlands, New Zealand, Norway, Poland, Romania, Russia, Singapore, Slovakia, Slovenia, South Africa, South Korea, Spain, Sweden, Switzerland, Taiwan, Thailand, Turkey, United Arab Emirates, USA, Vietnam.

Detailed addresses and additional representatives → www.sick.com