

READY FOR EXPLOSIVE ATMOSPHERES

EX II 2GD AND EX II 3GD

Safety light curtains, safety multibeam sensors

SICK
Sensor Intelligence.

SAFE PRODUCTIVITY – EVEN IN EXPLOSION-HAZARDOUS AREAS

In industries with explosion-hazardous areas, a single spark can be disastrous. The protective devices used in these environments must therefore be particularly rugged and reliable in order to meet the strict explosion protection requirements.



IGNITION SOURCES

Sparks, flames,
hot surfaces,
electronic devices, etc.



FLAMMABLE SUBSTANCES

Dusts, gases, steam, etc.

OXYGEN

When flammable gases, vapors and dusts are combined with oxygen in a particular mix ratio, they become explosive.

To ensure there are no ignition sources present when protecting hazardous areas, only explosion proof protective devices must be used.



Classification of explosion hazard

Probability of a flammable substance occurring under normal operating conditions	1999/92/EC Ex zone: Area in which explosive atmospheres could occur	2014/34/EU Device category (ATEX) and device protection level EPL (IEC Ex)
Exists all of the time, for long periods or often	Zone 0 (gases) Zone 20 (dusts)	1 G/D (gases/dusts) Highest level of protection with a very high degree of safety
Exists occasionally	Zone 1 (gases) Zone 21 (dusts)	2 G/D (gases/dusts) Increased level of protection with a high degree of safety
Unlikely to exist or occurs only infrequently or temporarily	Zone 2 (gases) Zone 22 (dusts)	3 G/D (gases/dusts) Normal level of protection with the required degree of safety
Responsible	Operating entity	Sensor manufacturer For the structure of the Ex variants from SICK, see page 4

Certification according to international safety standards



SAFETY, EVEN IN EXTREME CONDITIONS

As a global leader in the supply of opto-electronic protective devices, SICK has been effectively protecting humans and work environments for more than 65 years. Due to its versatile application possibilities, the deTec safety light curtain in particular is making a considerable contribution to ensuring safe productivity in nearly all industries and areas of application.



The deTec safety light curtains are ideal for the protection of hazardous areas, entrances, and hazardous points. Shorter downtimes and therefore higher productivity can be achieved thanks to the extensive and innovative diagnostic options. The standardized connectivity and the compatible accessories for the entire deTec product family considerably reduce configuration effort and enable quick commissioning. The required functions can be activated without software using the appropriate system plug with M12 connection.

Depending on the application, different Ex zones can be operated with the explosion-proof variants from the deTec product family.

Limiting explosions

3GD

Featuring a rugged and reliable housing design, the 3GD variants are specially designed and approved for use under the strict safety requirements found in hazardous locations. All devices can be cascaded, enable space-saving machine design and offer very high flexibility as there are no blind zones. A standardized connection and accessory concept saves time and money during commissioning.

Ex II 3GD

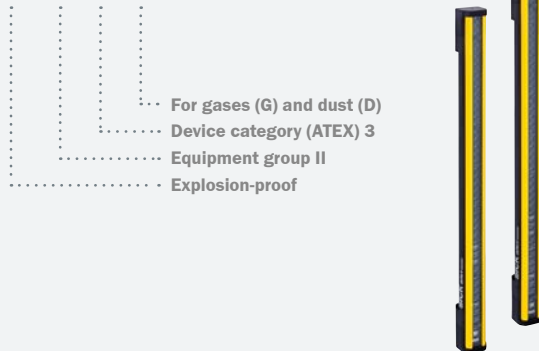

- For gases (G) and dust (D)
- Device category (ATEX) 3
- Equipment group II
- Explosion-proof

2GD

The SICK devices in their explosion-proof enclosures are approved in accordance with ATEX, IECEx and NEC. Pre-wired and fully mounted in the housing, the complete system is also UL-certified and represents a truly outstanding product that is unique on the market up to now.

Ex II 2GD

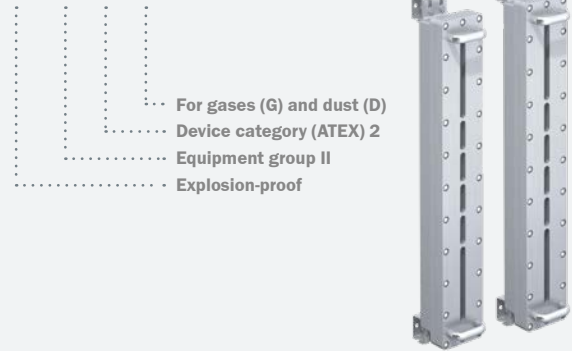

- For gases (G) and dust (D)
- Device category (ATEX) 2
- Equipment group II
- Explosion-proof

THESE ADVANTAGES IGNITE

+ Guaranteeing safety



- Maximum reliability and a very high level of safety for your employees thanks to certification according to international safety standards and compliance with the ATEX guidelines for use in explosion-hazardous areas
- Maximum safety for access protection of automated material transport due to reliable human-material differentiation without the need for an additional muting sensor
For the C4000 Fusion Ex, see page 80

+ Aim for high productivity



- Less downtime and increased machine availability due to exceptional ruggedness and reliability of all product components as well as extensive and innovative diagnostic options
- High availability due to fixed blanking: Detection of skids, suppression of obstructions such as cables
For the C4000 Fusion Ex, see page 80
- Efficient access protection due to high scanning ranges with low component requirements
For the deTem4 Core Ex, see page 86

+ Save time and money



- Easy mounting, installation and commissioning in systems thanks to the alignment aids, plus standardized connectivity and accessories
- Save installation time and certification costs thanks to the unique, UL-certified and pre-configured complete solution, equipped with cable and pre-assembled in explosion-proof enclosure (2GD variants)

+ Future-proof investment



- Various automation options enable the provision of information via IO-Link and subsequent use of data for downstream processes
- Technology leader due to smart and innovative on-site diagnostic options via NFC and “SICK Safety Assistant” mobile app
For the deTec4 Ex II 3GD, see page 10



THE ULTIMATE LEVEL OF EXPLOSION PROTECTION

Whether highly explosive steam is created when painting car bodies or due to flour dust in the air of bottling systems, there is a risk of explosion in many industrial production areas. The rugged and reliable housing design of the Ex versions of the safety light curtains and safety multibeam sensors from SICK prevent sparks from reaching explosive atmospheres. The risk of a potential ignition source is therefore averted.

AUTOMOTIVE AND PARTS SUPPLIERS

E.g. In paint shops

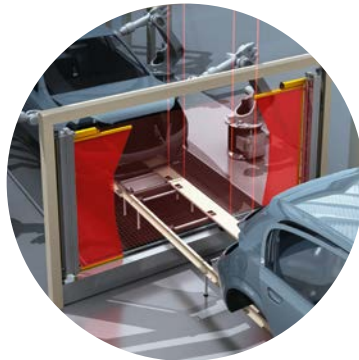

POWER

E.g. in coal, gas, or fuel plants



FOOD AND BEVERAGE
E.g. in flour filling facilities and distilleries

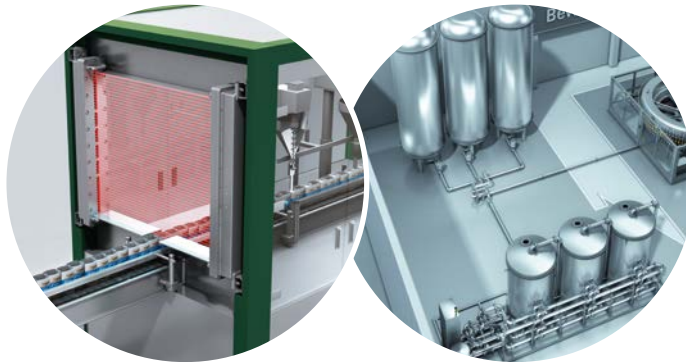

WOOD
E.g. in wood processing machines

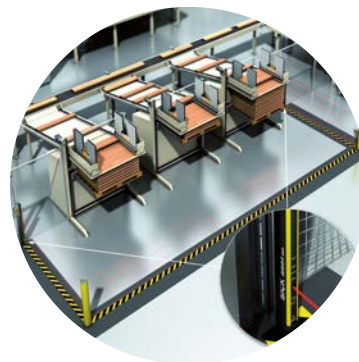



WASTE AND RECYCLING
E.g. in combustion and sewage treatment plants



Selection guide

Selection guide

Product	Device type		Safety-related parameters		Resolution				Number of beams, beam separation			Ambient operating temperature		Enclosure rating			
	Safety light curtain	Safety multibeam sensor	Type (IEC 61496)	Performance level (ISO 13849)	14 mm	20 mm	30 mm	40 mm	2 beams, 500 mm beam separation	3 beams, 400 mm beam separation	4 beams, 300 mm beam separation	0 °C ... +55 °C	-20 °C ... +55 °C	IP 65	IP 66	IP 67	
ATEX II 3G/3D																	
	deTec4 Ex II 3GD	■	4	e	■	■						■		■			
	deTec4 Core Ex II 3GD	■	4	e	■	■						■		■		■	
	deTec2 Core Ex II 3GD	■	2	c	■	■						■		■		■	
	C4000 Advanced ATEX II 3G/3D	■	4	e	■	■	■					■		■			
	C4000 Fusion ATEX II 3G/3D	■	4	e		■						■		■			
	C4000 Entry/Exit ATEX II 3G/3D	■	4	e		■						■		■			
	deTem4 Core Ex II 3GD		■	4	e					■	■	■	■		■		■
	deTem2 Core Ex II 3GD		■	2	c					■	■	■	■		■		■
ATEX II 2G/2D, NFPA 70/NEC 500, classes I, II, III, div. 1																	
	deTec4 Ex	■	4	e		■						■		■	■		
	deTec4 Core Ex	■	4	e		■						■		■	■		
	C4000 Advanced Ex	■	4	e		■					■			■	■		
	C4000 Fusion Ex	■	4	e		■						■		■	■		
	deTem4 Core Ex		■	4	e					■	■	■	■		■	■	

¹ Combined with a UE402 switching amplifier

² Devices with resolution 14 mm

	Functions																Diagnostics	Scanning range up to (m)	Page						
Protective operation	Restart interlock	External device monitoring (EDM)	Beam coding	Automated calibration of the protective field width	Configurable scanning range	Dynamic protective field width during operation	Bypass ¹	Operating mode switchover ¹	PSDI mode ¹	Reduced resolution	Fixed blanking	Floating blanking	Dynamic blanking for object pattern recognition	Self-teach dynamic Blanking for goods detection	Self-teach dynamic Blanking for pallet detection	Cascading	Smart presence detection	2-signal muting	Smart Box Detection ²	Safe SICK device communication via EFI/SDL	Application diagnostic output (ADO)	IO-Link	Near Field Communication (NFC)		

■	■	■	■	■	■	■				■						■	■	■	■		■	■	■	30	→ 10	
■				■																					15	→ 22
■				■																					15	→ On request
■	■	■	■		■		■	■	■	■	■	■									■	■			21	→ 28
■	■	■	■		■		■	■		■	■	■	■	■	■						■	■			21	→ 36
■	■	■	■		■		■	■					■								■	■			21	→ 46
■																									90	→ 54
■																									90	→ 60

■	■	■	■	■																	■				25.2	→ 66
■				■																					10	→ 70
■	■	■	■		■		■	■	■	■	■	■									■	■			16	→ 74
■	■	■	■		■		■	■		■	■	■	■	■	■						■	■			17.6	→ 80
■																									14.2	→ 86

READY FOR EXPLOSIVE ATMOSPHERES

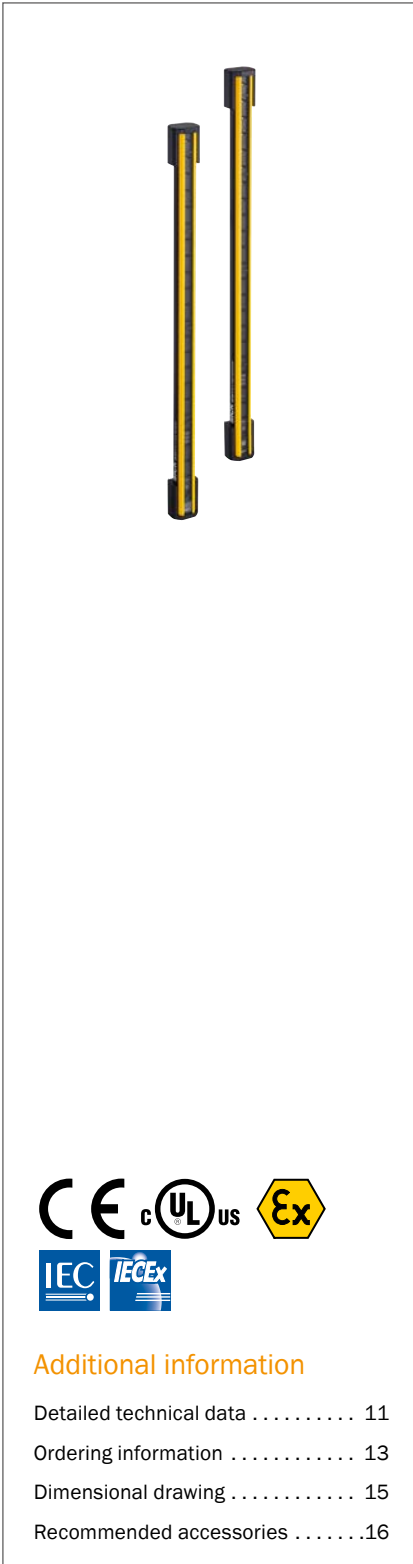

Product description

Featuring a rugged and reliable housing design, the deTec4 Ex II 3GD safety light curtain is specially designed and approved for use under the strict safety

requirements found in hazardous locations. The added safety and productivity it offers in explosive atmospheres make it a popular choice time and again.

At a glance

- Ex II 3GD classification thanks to modified deTec4 housing
- NFC diagnostics and mobile app
- Diagnostics and automation via IOLink
- 2-signal muting
- Reduced resolution: 1 or 2 beams
- Dynamic protective field width
- Configuration of all functions without software

Your benefits

- Maximum safety and automation in explosive atmospheres thanks to compliance with stringent regulations and strict safety requirements
- Less downtime thanks to comprehensive, innovative diagnostic options
- Differentiation between personnel and materials (muting) to maximize productivity
- Flexibility and safety for dynamic applications
- Easy commissioning and configuration without the need for software, plus a standardized housing design and accessories concept to save time and money

→ www.sick.com/deTec

For more information, simply enter the link or scan the QR code and get direct access to technical data, CAD design models, operating instructions, software, application examples, and much more.



Detailed technical data

Features

	Resolution 14 mm	Resolution 30 mm
Application	Explosive areas	
Ex-approvals	ATEX for gas: II 3G Ex ec op is IIC T4 Gc ATEX for dust: II 3D Ex tc IIIC T135°C Dc	
Protective field height	300 mm ... 2,100 mm (depending on type)	
Scanning range	20 m	30 m
No blind zones	Yes	
Synchronization	Optical synchronisation	
Integrated laser alignment aid	✓	

Safety-related parameters

Type	Type 4 (IEC 61496-1)
Safety integrity level	SIL3 (IEC 61508) SILCL3 (IEC 62061)
Category	Category 4 (ISO 13849-1)
Performance level	PL e (ISO 13849-1)
PFH₀ (mean probability of a dangerous failure per hour)	
Single device	15.3 x 10 ⁻⁹
Cascade with one guest	30.5 x 10 ⁻⁹
Cascade with two guest devices	45.6 x 10 ⁻⁹
T_M (mission time)	20 years (ISO 13849-1)
Safe state in the event of a fault	At least one OSSD is in the OFF state.

Functions

	System plug SP1	System plug SP1
Protective operation	✓	
Automatic calibration of the protective field width	✓	
Beam coding	✓	
Restart interlock	✓	
External device monitoring (EDM)	✓	
Cascading	✓	
Smart presence detection	-	✓
Reduced resolution	-	✓
Dynamic protective field width during operation	-	✓
Sender with reduced scanning range	-	✓
Differentiation between man and material (muting)	-	✓
2-signal muting	-	✓
Smart Box Detection	-	✓ ¹⁾

¹⁾ Only devices with resolution 14 mm. For details, see the operating instructions.

Interfaces

Connection type	System plug
System connection	Depending on system plug (male connector M12, 5-pin or 8-pin) ¹⁾

¹⁾ System plugs have to be ordered separately.

²⁾ For additional information on Flexi Soft → www.sick.com/Flexi_Soft

Extension connection	Depending on system plug (without extension connection or with female connector M12, 5-pin) ¹⁾
Configuration method	DIP switch on system plug
Display elements	LEDs
Display of the synchronization status of the upper and lower beams	✓
Application diagnostic output (ADO)	✓ (depending on system plug) ¹⁾
IO-Link	✓ (depending on system plug) ¹⁾
Near Field Communication (NFC)	✓
Fieldbus, industrial network	
Integration via Flexi Soft safety controller	CANopen, DeviceNet™, EtherCAT®, EtherNet/IP™, Modbus TCP, PROFIBUS DP, PROFINET ²⁾

¹⁾ System plugs have to be ordered separately.

²⁾ For additional information on Flexi Soft → www.sick.com/Flexi_Soft

Electrical data

Protection class	III (IEC 61140)
Supply voltage V_s	24 V DC (19.2 V ... 28.8 V)
Ripple	≤ 10 %
Output signal switching devices (OSSDs)	
Type of output	2 PNP semiconductors, short-circuit protected, cross-circuit monitored ¹⁾
ON state, switching voltage HIGH	24 V DC ($V_s - 2.25$ V DC ... V_s)
OFF state, switching voltage LOW	≤ 2 V DC
Current-carrying capacity per OSSD	≤ 500 mA
Application diagnostic output (ADO)	
Type of output	PNP semiconductor, short-circuit protected ¹⁾
Output voltage HIGH (active)	≥ $V_s - 3$ V
Output voltage LOW (deactivated)	High resistance
Output current HIGH (active)	≤ 100 mA

¹⁾ Applies to the voltage range between -30 V and +30 V.

Mechanical data

Dimensions	See dimensional drawing
Housing material	Aluminum extruded profile

Ambient data

Enclosure rating	IP65 (IEC 60529), IP67 (IEC 60529)
Ambient operating temperature	0 °C ... +55 °C
Storage temperature	-30 °C ... +70 °C
Air humidity	15 % ... 95 %, Non-condensing
Vibration resistance	5 g, 10 Hz ... 55 Hz (IEC 60068-2-6)
Shock resistance	10 g, 16 ms (IEC 60068-2-27)

Other information

Wave length	850 nm
Type of light	Near-infrared (NIR), invisible
Integrated laser alignment aid	✓
Laser class	1
Wave length	650 nm
Type of light	Visible red light

Ordering information

deTec4 Ex II 3GD

A deTec4 Ex II 3GD safety light curtain consists of:

- Sender
- Receiver
- System plug sender (always SP1)
- System plug receiver (SP1 or SP2) → The receiver system plug defines the available functions.

Selection aid deTec4 Ex II 3GD system plugs

System plugs for **stand-alone**:

- Sender: SP1
- Receiver: SP1 or SP2 (defines the available functions)

Options:

- System connection 5-pin or 8-pin (e.g. for RES, EDM, ADO, Muting)
- Receiver without or with extension connection (e.g. for RES, EDM, ADO, IO-Link, muting)

System plugs for **host/guest cascade**:

- Host sender: SP1 with extension connection
- Host receiver: SP1 or SP2 (defines the available functions) with extension connection
- Guest sender: SP1 with system connection M12, 5-pin
- Guest receiver: SP1 with system connection M12, 5-pin

Options:

- Host system connection 5-pin or 8-pin (e.g. for RES, EDM, ADO)
- Guest receiver without or with extension connection (e.g. for RES, EDM, ADO, IO-Link)

System plugs for **host/guest/guest cascade**:

- Host sender: SP1 with extension connection
- Host receiver: SP1 or SP2 (defines the available functions) with extension connection
- Guest1 sender: SP1 with system connection M12, 5-pin with extension connection
- Guest1 receiver: SP1 with system connection M12, 5-pin with extension connection
- Guest2 sender: SP1 with system connection M12, 5-pin
- Guest2 receiver: SP1 with system connection M12, 5-pin

Options:

- Host system connection 5-pin or 8-pin (e.g. for RES, EDM, ADO)
- Guest2 receiver without or with extension connection (e.g. for RES, EDM, ADO, IO-Link)

deTec4 Ex II 3GD: system plugs

Functions	Usage	System connection	Extension connection	Type	Part no.
SP1	Sender and receiver	Male connector M12, 5-pin	-	1000	2076832
			Female connector M12, 5-pin (RES, EDM, ADO, IO-Link, cascading)	1100	2076833
		Male connector M12, 8-pin (RES, EDM, ADO)	-	1200	2076834
			Female connector M12, 5-pin (RES, EDM, ADO, IO-Link, cascading)	1300	2076835
SP2	Receiver	Male connector M12, 5-pin	-	2000	2093097
			Female connector M12, 5-pin (RES, EDM, ADO, IO-Link, cascading, smart presence detection, muting)	2100	2093098
		Male connector M12, 8-pin (RES, EDM, ADO, muting)	-	2200	2093099
			Female connector M12, 5-pin (RES, EDM, ADO, IO-Link, cascading, smart presence detection, muting)	2300	2093100

deTec4 Ex II 3GD: Sender with regular scanning range, receiver without LED indicator lamp

- Scope of delivery of sender and receiver without system plug. The system plugs must be ordered separately.
- For products with “On request” please contact your SICK representative.

Resolution	Scanning range	Protective field height	Sender		Receiver	
			Type	Part no.	Type	Part no.
14 mm	20 m	300 mm	C4P-SX03011A00	1222438	C4P-EX03011C00	1222449
		450 mm	C4P-SX04511A00	1121851	C4P-EX04511C00	1223312
		600 mm	C4P-SX06011A00	1222439	C4P-EX06011C00	1222450
		750 mm	C4P-SX07511A00	On request	C4P-EX07511C00	On request
		900 mm	C4P-SX09011A00	On request	C4P-EX09011C00	On request
		1,050 mm	C4P-SX10511A00	1109101	C4P-EX10511C00	1109102
		1,200 mm	C4P-SX12011A00	On request	C4P-EX12011C00	On request
		1,350 mm	C4P-SX13511A00	On request	C4P-EX13511C00	1108872
		1,500 mm	C4P-SX15011A00	1106518	C4P-EX15011C00	1106519
		1,650 mm	C4P-SX16511A00	On request	C4P-EX16511C00	On request
		1,800 mm	C4P-SX18011A00	1222440	C4P-EX18011C00	1222451
		1,950 mm	C4P-SX19511A00	1110108	C4P-EX19511C00	1110109
		2,100 mm	C4P-SX21011A00	1121852	C4P-EX21011C00	1121853
30 mm	30 m	300 mm	C4P-SX03031A00	1222436	C4P-EX03031C00	1222447
		450 mm	C4P-SX04531A00	On request	C4P-EX04531C00	On request
		600 mm	C4P-SX06031A00	1121034	C4P-EX06031C00	1121035
		750 mm	C4P-SX07531A00	1108902	C4P-EX07531C00	1108903
		900 mm	C4P-SX09031A00	1109390	C4P-EX09031C00	1109391
		1,050 mm	C4P-SX10531A00	1108603	C4P-EX10531C00	1108605
		1,200 mm	C4P-SX12031A00	1106057	C4P-EX12031C00	1106058
		1,350 mm	C4P-SX13531A00	1106648	C4P-EX13531C00	1106649
		1,500 mm	C4P-SX15031A00	1222437	C4P-EX15031C00	1222448
		1,650 mm	C4P-SX16531A00	1121676	C4P-EX16531C00	1121677
		1,800 mm	C4P-SX18031A00	1107868	C4P-EX18031C00	1107869
		1,950 mm	C4P-SX19531A00	On request	C4P-EX19531C00	On request
		2,100 mm	C4P-SX21031A00	On request	C4P-EX21031C00	On request

deTec4 Ex II 3GD: Sender with reduced scanning range, receiver without LED indicator lamp

- Scope of delivery of sender and receiver without system plug. The system plugs must be ordered separately.
- For products with “On request” please contact your SICK representative.
- **Sender with reduced scanning range: ✓**

Resolution	Scanning range	Protective field height	Sender		Receiver	
			Type	Part no.	Type	Part no.
14 mm	2.5 m	300 mm	C4P-SX03011C00	On request	C4P-EX03011C00	1222449
		450 mm	C4P-SX04511C00	1223311	C4P-EX04511C00	1223312
		600 mm	C4P-SX06011C00	1107679	C4P-EX06011C00	1222450
		750 mm	C4P-SX07511C00	On request	C4P-EX07511C00	On request
		900 mm	C4P-SX09011C00	On request	C4P-EX09011C00	On request
		1,050 mm	C4P-SX10511C00	On request	C4P-EX10511C00	1109102
		1,200 mm	C4P-SX12011C00	On request	C4P-EX12011C00	On request
		1,350 mm	C4P-SX13511C00	1108871	C4P-EX13511C00	1108872
		1,500 mm	C4P-SX15011C00	On request	C4P-EX15011C00	1106519
		1,650 mm	C4P-SX16511C00	On request	C4P-EX16511C00	On request
		1,800 mm	C4P-SX18011C00	On request	C4P-EX18011C00	1222451
		1,950 mm	C4P-SX19511C00	On request	C4P-EX19511C00	1110109
		2,100 mm	C4P-SX21011C00	On request	C4P-EX21011C00	1121853

Dimensional drawing (Dimensions in mm)

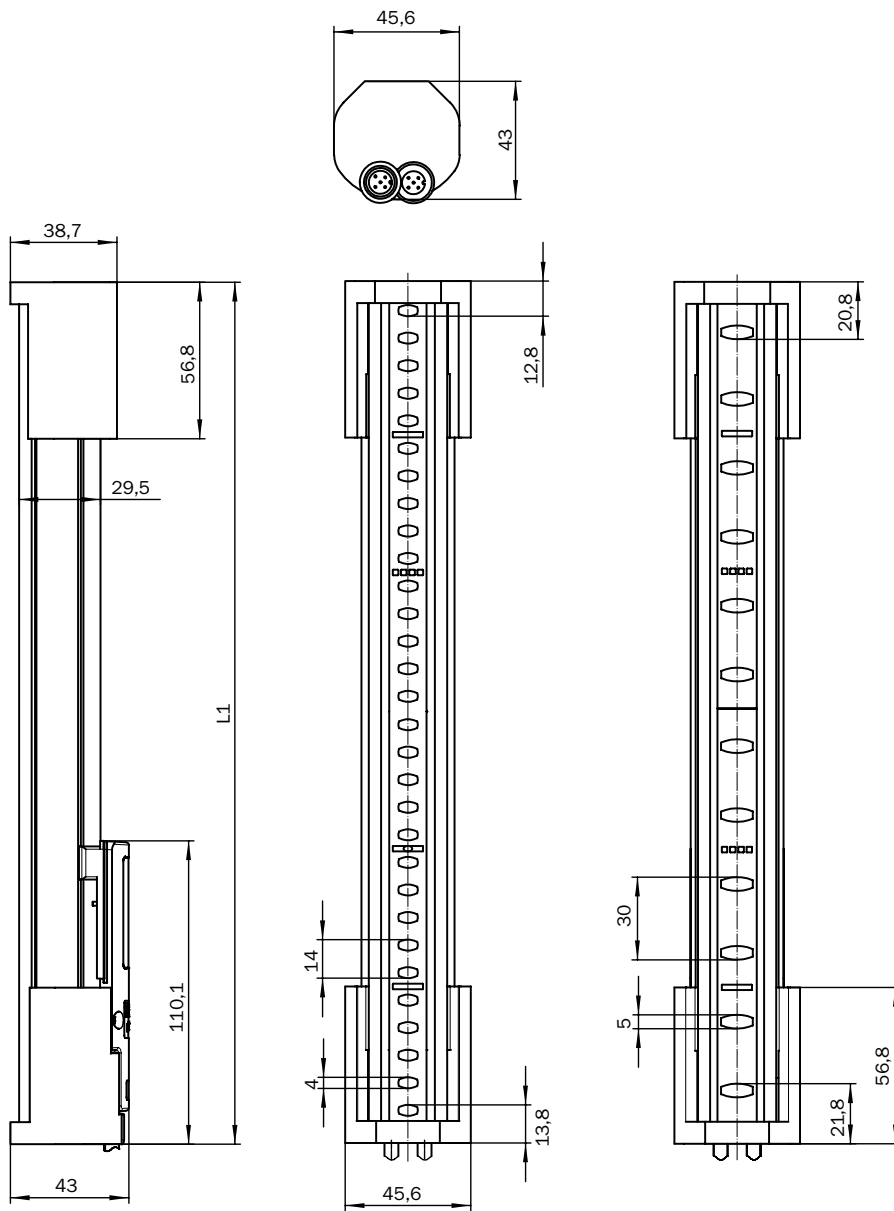





Protective field height	L1
300	313
450	463
600	613
750	763
900	913
1.050	1.063
1.200	1.213
1.350	1362
1.500	1.512
1.650	1.662
1.800	1.812
1.950	1.962
2.100	2.112

Recommended accessories

Mounting systems

Terminal and alignment brackets

Figure	Description	Packing unit	Suitable for	Type	Part no.
	QuickFix bracket	2 pieces	1 device (sender or receiver)	BEF-3SHABPKU2	2066048
		4 pieces	2 devices (sender and receiver)	BEF-3SHABPKU4	2098710
	FlexFix bracket Sensor alignment $\pm 15^\circ$ Including screw M5	2 pieces	1 device (sender or receiver)	BEF-1SHABPKU2	2098709
		4 pieces	2 devices (sender and receiver)	BEF-1SHABPKU4	2066614
	Mounting kit FlexFix (FlexFix brackets, alignment tool and mounting material suitable for fastening to device columns PU3H)	2 pieces	1 device (sender or receiver)	BEF-1SHABBKU2	2073543
	FlexFix replacement kit (Mounting kit for replacement of swivel mount brackets 2019649 and 2019659 or side bracket 2019506 with the FlexFix bracket when using the wells provided)	4 pieces	2 devices (sender and receiver)	BEF-1SHABS004	2100345
	FlexFix replacement kit (Mounting kit for replacement of swivel mount brackets 2030510 or side bracket 2019506 with the FlexFix bracket when using the wells provided)	4 pieces	2 devices (sender and receiver)	BEF-1SHABU004	2099282

Dimensional drawings → [page 30](#)

Mounting tools

Figure	Description	Packing unit	Suitable for	Type	Part no.
	Alignment tool for sensor alignment in areas with limited accessibility, e.g. device columns PU3H	1 piece	FlexFix bracket, Compact FlexFix bracket	Alignment tool	4084133

Front screen protection

Figure	Description	Packing unit	Suitable for	Type	Part no.
	Self-adhesive protective film for the front screen (protects sensors from damage by flying sparks and welding beads)	1 piece	Sufficient for two sensors with a protective field height of 2.100 mm	Self-adhesive protective film	2069268

Protective caps





Figure	Description	Type	Part no.
	For a deTec4 sender with extension connection that does not have an additional guest connected to it, the extension connection has no function and must be sealed with a protective cap.	Protective cap, M12 for female connector	5310772

Connection systems

Plug connectors and cables



Connecting cables

- **Model:** PUR, halogen-free, unshielded

Figure	Connection type		Conductor cross-section	Length of cable	Type	Part no.
	Female connector M12, 5-pin, straight	Flying leads	0.34 mm ²	2 m	YF2A15-020UB5XLEAX	2095617
				5 m	YF2A15-050UB5XLEAX	2095618
				10 m	YF2A15-100UB5XLEAX	2095619
				15 m	YF2A15-150UB5XLEAX	2095620
				20 m	YF2A15-200UB5XLEAX	2095614
				30 m	YF2A15-300UB5XLEAX	2095621
	Female connector M12, 5-pin, angled	Flying leads	0.34 mm ²	2 m	YG2A15-020UB5XLEAX	2095772
				5 m	YG2A15-050UB5XLEAX	2095773
				10 m	YG2A15-100UB5XLEAX	2095774
	Female connector M12, 8-pin, straight	Flying leads	0.25 mm ²	2 m	YF2A18-020UA5XLEAX	2095652
				5 m	YF2A18-050UA5XLEAX	2095653
				7.5 m	YF2A18-075UA5XLEAX	2099230
				10 m	YF2A18-100UA5XLEAX	2095654
				15 m	YF2A18-150UA5XLEAX	2095679
				20 m	YF2A18-200UA5XLEAX	2095680
	Female connector M12, 8-pin, angled	Flying leads	0.25 mm ²	2 m	YG2A18-020UA5XLEAX	2095779
				5 m	YG2A18-050UA5XLEAX	2095780
				10 m	YG2A18-100UA5XLEAX	2095781







Connection cables

- **Model:** PUR, halogen-free, unshielded

Figure	Connection type		Conductor cross-section	Length of cable	Type	Part no.
	Female connector M12, 5-pin, straight	Male connector, M12, 5-pin, straight	0.34 mm ²	0.6 m	YF2A15-C60UB5M2A15	2096006
				1 m	YF2A15-010UB5M2A15	2096007
				2 m	YF2A15-020UB5M2A15	2096009
				5 m	YF2A15-050UB5M2A15	2096010
				10 m	YF2A15-100UB5M2A15	2096011
				15 m	YF2A15-150UB5M2A15	2096171
	Female connector M12, 8-pin, straight	Male connector, M12, 8-pin, straight	0.25 mm ²	0.6 m	YF2A18-C60UA5M2A18	2096031
				1 m	YF2A18-010UA5M2A18	2096032
				2 m	YF2A18-020UA5M2A18	2096033
				5 m	YF2A18-050UA5M2A18	2096034
				10 m	YF2A18-100UA5M2A18	2096035

Replacement cables (replacement of C4000 with deTec)

- **Length of cable:** 0,25 m
- **Items supplied:** 2 cables

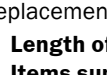
Figure	Connection type		Model	Type	Part no.
	deTec system connection	Replacement C4000			
	Female connector, M12, 5-pin, straight	Male connector, M12, 8-pin, straight	PVC, unshielded	DSL-1285GM25034KM1	2070987
		Male connector, M26, 12-pin, straight	PVC, unshielded	DSL-6182GM25034KM1	2070989
		Male connector, M26, 7-pin, straight	PVC, unshielded	DSL-6187GM25034KM1	2070988
	Female connector, M12, 8-pin, straight	Male connector, M12, 8-pin, straight	PUR, halogen-free, unshielded	DSL-6108GM25034KM1	2034865
		Male connector, M26, 12-pin, straight (RES)	PUR, halogen-free, unshielded	DSL-6129GM25034KM1	2081442
		Male connector, M26, 12-pin, straight (ADO)	PUR, halogen-free, unshielded	DSL-6129GM25034KM7	2112706
		Male connector, M26, 7-pin, straight	PUR, halogen-free, unshielded	DSL-6130GM25034KM1	2081443

Replacement cables (replacement of C2000 with deTec)

- **Length of cable:** 0,25 m
- **Items supplied:** 1 cable





Figure	Connection type		Model	Type	Part no.
	deTec system connection	Replacement C2000			
	Female connector, M12, 8-pin, straight	Male connector, M12, 8-pin, straight (sender)	PUR, unshielded	DSL-1M08G0M2D25KM4	2120145
		Male connector, M12, 8-pin, straight (receiver)		DSL-1M08GM25D25KM4	2120144

Modules and gateways

Connection modules

Figure	Description	Type	Part no.
	IO-Link V1.1 Class A port, USB2.0 port, optional external power supply 24 V / 1 A	IOLA2US-01101 (SiLink2 Master)	1061790

T-connectors and pushbuttons

Figure	Description	Type	Part no.
	T-connector M12, 5-pin For simultaneous connection to sender and receiver. Splits the cable from the control cabinet to the sender and receiver.	DSC-1205T000025KM0	6030664
	T-connector M12, 8-pin For simultaneous connection to sender and receiver. Splits the cable from the control cabinet to the sender and receiver.	DSC-1208T000025KM0	6058647
	T-connector with pushbutton for laser alignment aid, M12, 5-pin For simultaneous connection to sender and receiver. Splits the cable from the control cabinet to the sender and receiver. The pushbutton makes it possible to switch on and off the laser alignment aid integrated into the deTec4 Prime sender.	T-connector with pushbutton for laser alignment aid, M12, 5-pin	2077933
	Pushbutton for laser alignment aid, M12, 5-pin The pushbutton makes it possible to switch on and off the laser alignment aid integrated into the deTec4 Prime sender.	Pushbutton for laser alignment aid, M12, 5-pin	2082166
	Pushbutton for laser alignment aid, M12, 8-pin The pushbutton makes it possible to switch on and off the laser alignment aid integrated into the deTec4 Prime sender.	Pushbutton for laser alignment aid, M12, 8-pin	2082167

Connectors



Figure	Description	Type	Part no.
	The IO-Link connector is used to establish a connection between suitable devices and an IO-Link master, enabling communication via IO-Link. The IO-Link connector can also be used to connect up to 2 muting sensors.	IO-Link connector	2092757

Power supply units and power supply cables

Figure	Input voltage	Output voltage	Output current	Type	Part no.
	100 V AC ... 240 V AC	24 V DC	≤ 2.1 A	PS50WE24V	7028789
			≤ 3.9 A	PS95WE24V	7028790



Reflectors and optics

Alignment aids

Figure	Description	Type	Part no.
	Laser alignment aid AR 60, Laser class 2 (IEC 60825). Do not look into the beam!	AR60	1015741
	Adapter AR60 for deTec, deTem and MLG-2	AR60 adapter, deTec, deTem, MLG-2	4070854

Further accessories

Test and monitoring tools

Figure	Description	Type	Part no.
	14 mm diameter	Test rod 14 mm	2022599
	24 mm diameter (An effective resolution of 24 mm can be achieved with a physical resolution of 14 mm using the function reduced resolution by 1 beam)	Test rod 24 mm	2045592
	30 mm diameter	Test rod 30 mm	2022602
	34 mm diameter (An effective resolution of 34 mm can be achieved with a physical resolution of 14 mm using the function reduced resolution by 2 beams)	Test rod 34 mm	2045593
	Test rod holder	BEF-3WNAAAAL1	2052249

Cleaning agent

Figure	Description	Type	Part no.
	Cloth for cleaning the front screen	Lens cloth	4003353
	Plastic cleaner and care product, anti-static, 0.5 liter	Plastic cleaner	5600006



Safety command devices

Reset pushbuttons

Figure	Description	Items supplied	Type	Part no.
	Reset pushbutton	Including retaining clip, "RESET" cover and "RESET/OVERRIDE" cover	ER12-SB3C5	6045316

Sensor Integration Gateway

SIG200

Figure	Brief description	Type	Part no.
	<ul style="list-style-type: none"> • Further functions: Web server available, USB connection for easy configuration of the SIG200 Sensor Integration Gateway with SOPAS ET, the engineering tool from SICK, logic editor is available for easy configuration of logic functions • I/O connection: 4 x M12, 5-pin female connector, A-coded • Connection CONFIG: 1 x M8, 4-pin female connector, USB 2.0 (USB-A) • Logic editor: yes • Communication interface: IO-Link, USB, Ethernet, PROFINET, REST API • Product category: IO-Link Master 	SIG200-0A0412200	1089794
	<ul style="list-style-type: none"> • Description: The SIG200 Sensor Integration Gateway is an IO-Link master with 4 configurable ports through which the IO-Link devices or standard inputs or standard outputs can be connected to a PLC or cloud application using the REST API. • Further functions: Web server available, USB connection for easy configuration of the SIG200 Sensor Integration Gateway with SOPAS ET, the engineering tool from SICK, logic editor is available for easy configuration of logic functions • I/O connection: 4 x M12, 5-pin female connector, A-coded • Connection CONFIG: 1 x M8, 4-pin female connector, USB 2.0 (USB-A) • Logic editor: yes • Communication interface: IO-Link, USB, Ethernet, EtherNet/IP™, REST API • Product category: IO-Link Master 	SIG200-0A0512200	1089796
	<ul style="list-style-type: none"> • Further functions: Web server available, USB connection for easy configuration of the SIG200 Sensor Integration Gateway with SOPAS ET, the engineering tool from SICK, logic editor is available for easy configuration of logic functions • I/O connection: 4 x M12, 5-pin female connector, A-coded • Connection CONFIG: 1 x M8, 4-pin female connector, USB 2.0 (USB-A) • Logic editor: yes • Communication interface: IO-Link, USB, Ethernet, REST API • Product category: IO-Link Master 	SIG200-0A0G12200	1102605

SAFETY IN EXPLOSIVE ATMOSPHERES

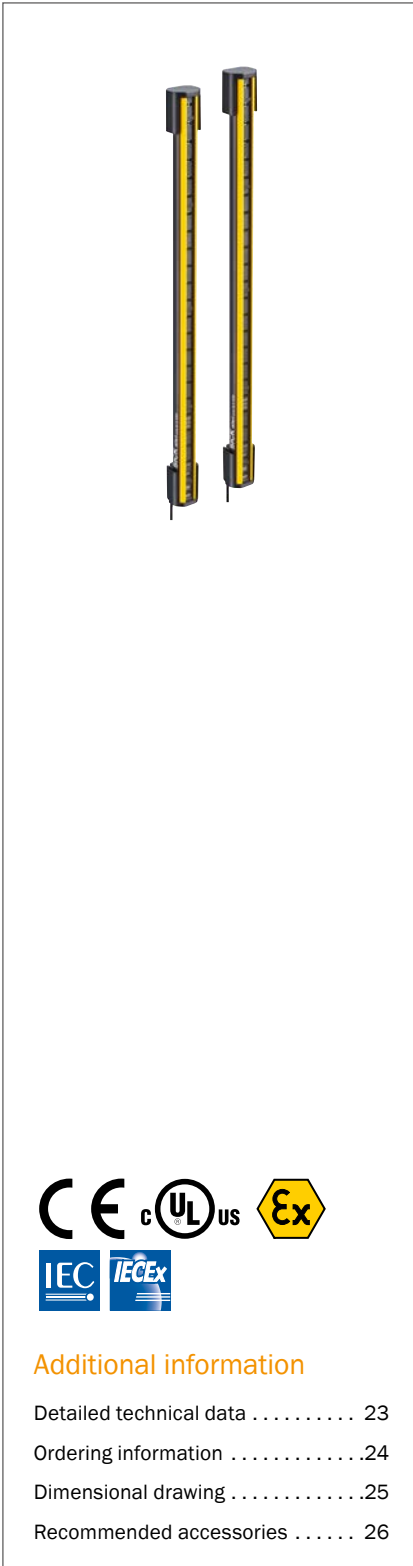

Product description

Rugged and reliable safety technology is very important in industries with explosion-hazardous areas. A single spark can be disastrous. With the special version of the deTec4 Core Ex II 3GD safety light curtain, SICK is ensuring compliance with the high safety requirements in explosive areas. It fulfills the requirements of the ATEX guidelines for use in explosion-hazardous areas (ATEX

for gas: II 3G EX and ATEX for dust: II 3D Ex). Thanks to the high resistance and reliability, the safety light curtain is particularly well-suited for use in tough industrial settings. The deTec4 Core Ex II 3GD offers maximum reliability and very high safety for employees, even in explosive atmospheres.

At a glance

- ATEX for gas: II 3G Ex ec op is IIC T4 Gc
- ATEX for dust: II 3D Ex tc IIIC T135°C Dc
- Innovative bracket
- No blind zones
- Automated calibration of the protective field width
- LED alignment and output display
- Standardized connectivity: M12 male connector, 5-pin connection, compatible with Flexi Loop
- Enclosure ratings: IP65 and IP67

Your benefits

- Uniform housing and accessory concept for standard and special industrial environments saves time and money when planning systems
- Innovative bracket concept for easy mounting saves installation time and costs
- No blind zones for very high flexibility and space-saving machine design
- Quick installation thanks to integrated LED display and automated calibration of the protective field width save time and money
- Standardized connectivity for Flexi Loop integration saves time and money when it comes to installation
- Enclosure ratings IP65, IP67 and temperature resistance offer long sensor life times and therefore even more efficiency

→ www.sick.com/deTec

For more information, simply enter the link or scan the QR code and get direct access to technical data, CAD design models, operating instructions, software, application examples, and much more.



Detailed technical data

Features

	Resolution 14 mm	Resolution 30 mm
Application	Explosive areas	
Ex-approvals	ATEX for gas: II 3G Ex ec op is IIC T4 Gc ATEX for dust: II 3D Ex tc IIIC T135°C Dc	
Protective field height	300 mm ... 2,100 mm (depending on type)	
Scanning range	10 m	15 m
No blind zones	Yes	
Synchronization	Optical synchronisation	

Safety-related parameters

Type	Type 4 (IEC 61496-1)
Safety integrity level	SIL3 (IEC 61508) SILCL3 (IEC 62061)
Category	Category 4 (ISO 13849-1)
Performance level	PL e (ISO 13849-1)
PFH_D (mean probability of a dangerous failure per hour)	3.7 x 10 ⁻⁹
T_M (mission time)	20 years (ISO 13849-1)
Safe state in the event of a fault	At least one OSSD is in the OFF state.

Functions

Protective operation	✓
Automatic calibration of the protective field width	✓

Interfaces

Connection type	Male connector M12, 5-pin
Display elements	LEDs
Fieldbus, industrial network	
Integration via Flexi Soft safety controller	CANopen, DeviceNet™, EtherCAT®, EtherNet/IP™, Modbus TCP, PROFIBUS DP, PROFINET ¹⁾

¹⁾ For additional information on Flexi Soft → www.sick.com/Flexi_Soft

Electrical data

Protection class	III (IEC 61140)
Supply voltage V_s	24 V DC (19.2 V ... 28.8 V)
Ripple	≤ 10 %
Output signal switching devices (OSSDs)	
Type of output	2 PNP semiconductors, short-circuit protected, cross-circuit monitored ¹⁾
ON state, switching voltage HIGH	24 V DC (V _s - 2.25 V DC ... V _s)
OFF state, switching voltage LOW	≤ 2 V DC
Current-carrying capacity per OSSD	≤ 300 mA

¹⁾ Applies to the voltage range between -30 V and +30 V.

Mechanical data

Dimensions	See dimensional drawing
Housing material	Aluminum extruded profile

Ambient data

Enclosure rating	IP65 (IEC 60529) IP67 (IEC 60529)
Ambient operating temperature	0 °C ... +55 °C
Storage temperature	-30 °C ... +70 °C
Air humidity	15 % ... 95 %, Non-condensing
Vibration resistance	5 g, 10 Hz ... 55 Hz (IEC 60068-2-6)
Shock resistance	10 g, 16 ms (IEC 60068-2-27)

Other information

Wave length	850 nm
Type of light	Near-infrared (NIR), invisible

Ordering information

Resolution	Scanning range	Protective field height	Sender		Receiver	
			Type	Part no.	Type	Part no.
14 mm	10 m	300 mm	C4C-SX03010A10000	1220313	C4C-EX03010A10000	1220326
		450 mm	C4C-SX04510A10000	1220314	C4C-EX04510A10000	1220327
		600 mm	C4C-SX06010A10000	1220315	C4C-EX06010A10000	1220328
		750 mm	C4C-SX07510A10000	1220316	C4C-EX07510A10000	1220329
		900 mm	C4C-SX09010A10000	1220317	C4C-EX09010A10000	1220330
		1,050 mm	C4C-SX10510A10000	1220318	C4C-EX10510A10000	1220331
		1,200 mm	C4C-SX12010A10000	1220319	C4C-EX12010A10000	1220332
		1,350 mm	C4C-SX13510A10000	1220320	C4C-EX13510A10000	1220333
		1,500 mm	C4C-SX15010A10000	1220321	C4C-EX15010A10000	1220334
		1,650 mm	C4C-SX16510A10000	1220322	C4C-EX16510A10000	1220335
		1,800 mm	C4C-SX18010A10000	1220323	C4C-EX18010A10000	1220336
		1,950 mm	C4C-SX19510A10000	1220324	C4C-EX19510A10000	1220337
30 mm	15 m	2,100 mm	C4C-SX21010A10000	1220325	C4C-EX21010A10000	1220338
		300 mm	C4C-SX03030A10000	1220339	C4C-EX03030A10000	1220352
		450 mm	C4C-SX04530A10000	1220340	C4C-EX04530A10000	1220353
		600 mm	C4C-SX06030A10000	1220341	C4C-EX06030A10000	1220354
		750 mm	C4C-SX07530A10000	1220342	C4C-EX07530A10000	1220355
		900 mm	C4C-SX09030A10000	1220343	C4C-EX09030A10000	1220356
		1,050 mm	C4C-SX10530A10000	1220344	C4C-EX10530A10000	1220357
		1,200 mm	C4C-SX12030A10000	1220345	C4C-EX12030A10000	1220358
		1,350 mm	C4C-SX13530A10000	1220346	C4C-EX13530A10000	1220359
		1,500 mm	C4C-SX15030A10000	1220347	C4C-EX15030A10000	1220360
		1,650 mm	C4C-SX16530A10000	1220348	C4C-EX16530A10000	1220363
		1,800 mm	C4C-SX18030A10000	1220349	C4C-EX18030A10000	1220362
1,950 mm	C4C-SX19530A10000	1220350	C4C-EX19530A10000	1220361		
		2,100 mm	C4C-SX21030A10000	1220351	C4C-EX21030A10000	1220364

Dimensional drawing (Dimensions in mm (inch))

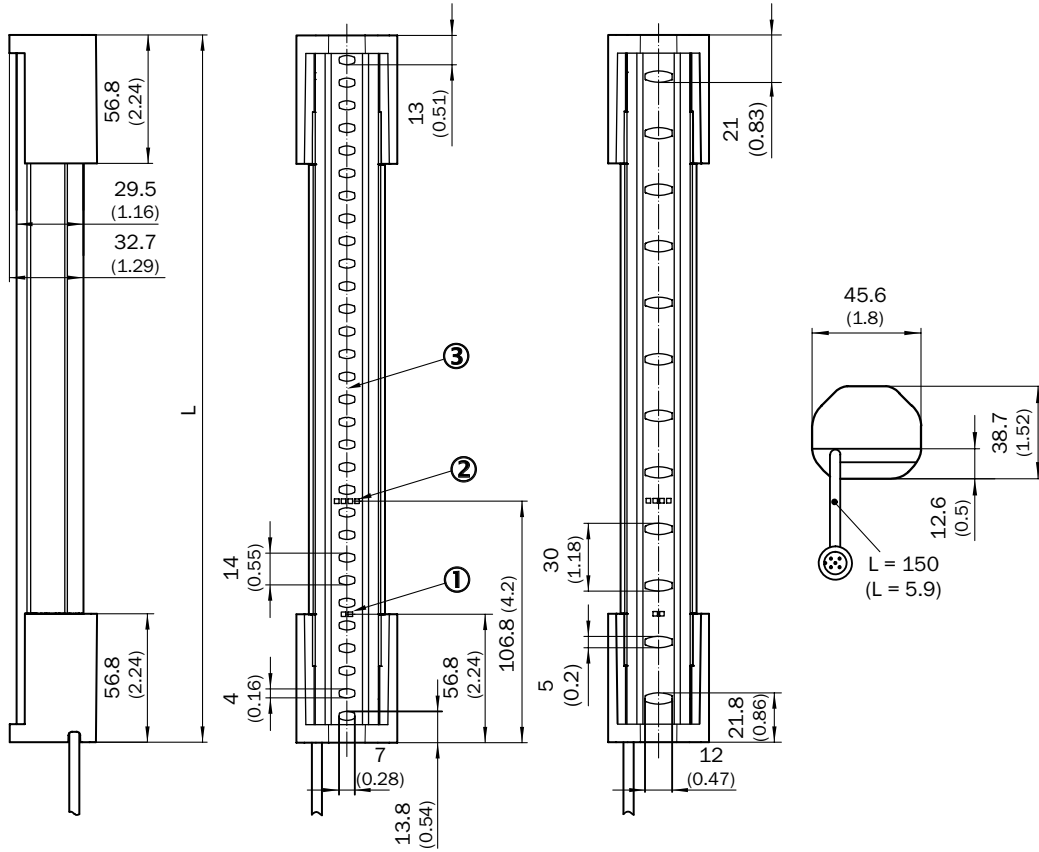





- ① Operating indicator
- ② Alignment indicator
- ③ Optical axis

		L
	300 (11.81)	313 (12.32)
	450 (17.72)	463 (18.23)
	600 (23.62)	613 (24.13)
	750 (29.53)	763 (30.04)
	900 (35.43)	913 (35.94)
	1,050 (41.34)	1,063 (41.85)
	1,200 (47.24)	1,213 (47.76)
	1,350 (53.15)	1,362 (53.62)
	1,500 (59.05)	1,512 (59.53)
	1,650 (64.96)	1,662 (65.43)
	1,800 (70.87)	1,812 (71.34)
	1,950 (76.77)	1,962 (77.24)
	2,100 (82.68)	2,112 (83.15)

Recommended accessories

Mounting systems

Terminal and alignment brackets

Figure	Description	Packing unit	Type	Part no.
	FlexFix mounting kit for 1 device, e.g. sender or receiver (FlexFix bracket, alignment tool and assembly materials for installation in PU3H device columns), plastic	2 pieces	BEF-1SHABBKU2	2073543
	FlexFix replacement bracket (mounting kit for replacement of swivel mount brackets 2030510 or side bracket 2019506 with the FlexFix bracket when using the wells provided), Aluminum (anodised), plastic	4 pieces	BEF-1SHABU004	2099282
	FlexFix replacement bracket (mounting kit for replacement of swivel mount brackets 2019649 and 2019659 or side bracket 2019506 with the FlexFix bracket when using the wells provided), Aluminum (anodised), plastic	4 pieces	BEF-1SHABS004	2100345
	FlexFix bracket for 1 device (e.g. sender or receiver), can be aligned $\pm 15^\circ$, including M5 screw, plastic	2 pieces	BEF-1SHABPKU2	2098709
	FlexFix bracket for 2 devices (e.g. sender and receiver), can be aligned $\pm 15^\circ$, including M5 screw, plastic	4 pieces	BEF-1SHABPKU4	2066614
	QuickFix bracket for 1 device (e.g. sender or receiver), plastic	2 pieces	BEF-3SHABPKU2	2066048
	QuickFix bracket for 2 devices (e.g. sender and receiver), plastic	4 pieces	BEF-3SHABPKU4	2098710

Other mounting accessories

Mounting tools



Figure	Description	Packing unit	Type	Part no.
	Alignment tool for aligning sensors in areas with limited accessibility, e.g. device columns	1 piece	Alignment tool	4084133

Connection systems

Plug connectors and cables



Connecting cables

- **Model:** PUR, halogen-free, unshielded

Figure	Connection type		Conductor cross-section	Length of cable	Type	Part no.
	Female connector, M12, 5-pin, straight	Flying leads	0.34 mm ²	2 m	YF2A15-020UB5XLEAX	2095617
				5 m	YF2A15-050UB5XLEAX	2095618
				10 m	YF2A15-100UB5XLEAX	2095619
				15 m	YF2A15-150UB5XLEAX	2095620
				20 m	YF2A15-200UB5XLEAX	2095614
				30 m	YF2A15-300UB5XLEAX	2095621
	Female connector, M12, 5-pin, angled	Flying leads	0.34 mm ²	2 m	YG2A15-020UB5XLEAX	2095772
				5 m	YG2A15-050UB5XLEAX	2095773
				10 m	YG2A15-100UB5XLEAX	2095774

Replacement cables (replacement of C4000 with deTec Core)

- **Length of cable:** 0,25 m
- **Items supplied:** 2 cables

Figure	Connection type		Model	Type	Part no.
	deTec system connection	Replacement C4000			
	Female connector, M12, 5-pin, straight	Male connector, M12, 8-pin, straight	PVC, unshielded	DSL-1285GM25034KM1	2070987
		Male connector, M26, 12-pin, straight	PVC, unshielded	DSL-6182GM25034KM1	2070989
		Male connector, M26, 7-pin, straight	PVC, unshielded	DSL-6187GM25034KM1	2070988



Adapters and distributors

T-junctions

Figure	Description	Type	Part no.
	T-piece for simultaneous connection to sender and receiver, splits the cable from the control cabinet to the sender and receiver, 5-pin	DSC-1205T000025KM0	6030664



Reflectors and optics

Alignment aids

Figure	Description	Type	Part no.
	Laser alignment aid for various sensors, laser class 2 (IEC 60825). Do not look into the beam!	AR60	1015741
	Adapter AR60 for deTec4, deTec2 and MLG-2	AR60 adapter, deTec, deTem, MLG-2	4070854

Further accessories

Test and monitoring tools

Figure	Description	Type	Part no.
	14 mm diameter	Test rod 14 mm	2022599
	30 mm diameter	Test rod 30 mm	2022602
	Test rod holder	BEF-3WNAAAAL1	2052249

TOTAL FLEXIBILITY – EVEN IN EXPLOSIVE ENVIRONMENTS

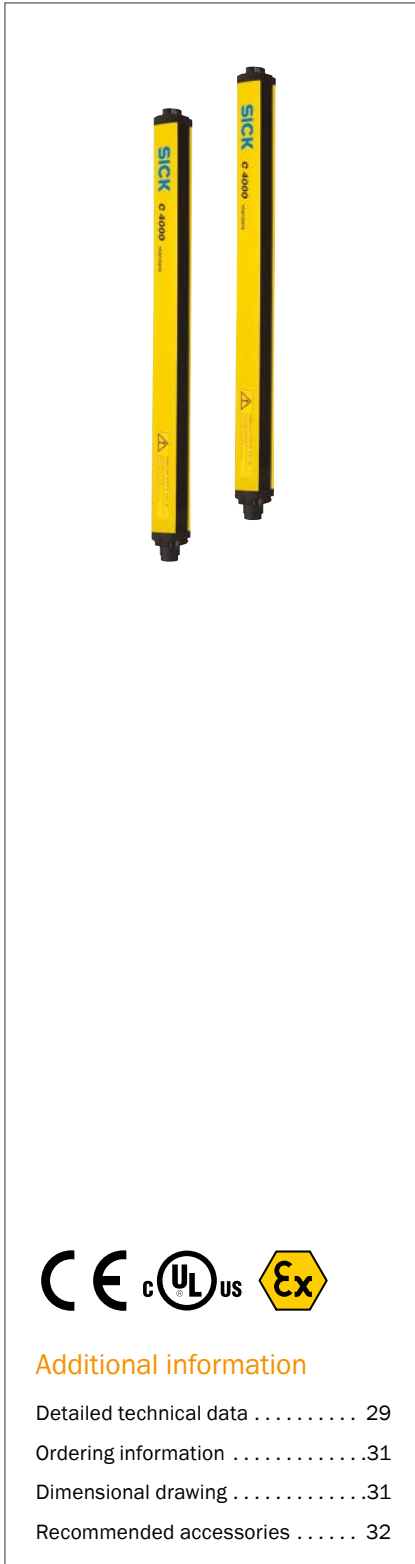

Product description

The C4000 Advanced ATEX II 3G/3D safety light curtain is a cost-effective, reliable solution that safeguards hazardous points and areas, even in potentially explosive atmospheres. Functions such as the restart interlock (RES) and external device monitoring (EDM) provide easy machine integration. Vari-

ous mounting adapters and innovative accessories enable flexible installation. The industry-tested 7-segment display saves time during alignment and diagnostics. Plus, the C4000 Advanced ATEX II 3G/3D safeguards areas with up to an 1,800 mm protective field height.

At a glance

- Type 4 (IEC 61496), SIL3 (IEC 61508), PL e (EN ISO 13849)
- ATEX II 3G/3D (2/22 zones)
- ATEX for gas: II 3G Ex nA op is IIC T4 Gc X
- ATEX for dust: II 3D Ex tc IIIC T135°C Dc
- 7-segment display
- External device monitoring (EDM) and restart interlock (RES)
- Beam coding for correct system allocation
- Configuration and diagnostics via PC

Your benefits

- ATEX II 3G/3D for use in zones 2/22
- Large sensing ranges up to 21 m and sufficient power reserve for use in paint finishing lines, for example
- Time-saving alignment and diagnostics by means of 7-segment display
- Beam coding protects the systems against mutual interference and thus offers a high level of availability
- Quick and easy commissioning by means of pre-configuration of the systems or clone plug
- Convenient configuration and diagnostics ensure increased availability



Additional information

Detailed technical data	29
Ordering information	31
Dimensional drawing	31
Recommended accessories	32

→ www.sick.com/C4000_Advanced_ATEX_II_3G_3D

For more information, simply enter the link or scan the QR code and get direct access to technical data, CAD design models, operating instructions, software, application examples, and much more.



Detailed technical data

Features

	Resolution 14 mm	Resolution 30 mm	Resolution 40 mm
Application	Explosive areas		
Ex-approvals	ATEX for gas: II 3G Ex nA op is IIC T4 Gc X ATEX for dust: II 3D Ex tc IIIC T135°C Dc		
Protective field height	450 mm / 1,800 mm (depending on type)	900 mm / 1,500 mm / 1,800 mm (depending on type)	1,350 mm
Scanning range	10 m	21 m	
Synchronization	Optical synchronisation		

Safety-related parameters

Type	Type 4 (IEC 61496-1)
Safety integrity level	SIL3 (IEC 61508) SILCL3 (EN 62061)
Category	Category 4 (EN ISO 13849)
Performance level	PL e (EN ISO 13849)
PFH_d (mean probability of a dangerous failure per hour)	15 x 10 ⁻⁹ (EN ISO 13849)
T_M (mission time)	20 years (EN ISO 13849)
Safe state in the event of a fault	At least one OSSD is in the OFF state.

Functions

	Functions	Delivery status
Protective operation	✓	
Restart interlock	✓	External
External device monitoring (EDM)	✓	Deactivated
Beam coding	✓	Uncoded
Configurable scanning range	✓	
Reduced resolution	✓	Deactivated
Fixed blanking	✓	Deactivated
Floating blanking	✓	Deactivated
Safe SICK device communication via EFI	✓	

Functions in combination with UE402

Bypass	✓
Operating mode switching	✓
PSDI mode	✓

Interfaces

System connection	
Connection type	Hirschmann male connector M26, 12-pin
Permitted cable length	50 m ¹⁾
Conductor cross-section	0.75 mm ²
Configuration connection	

¹⁾ Depending on load, power supply and wire cross-section. The technical specifications must be observed.

²⁾ For a suitable EFI-gateway see modules and gateways in the accessory section of connection systems.

³⁾ For additional information on Flexi Soft → www.sick.com/Flexi_Soft

Connection type	Female connector M8, 4-pin
Configuration method	PC with CDS (Configuration and Diagnostic Software)
Display elements	7-segment display
Fieldbus, industrial network	
Integration via EFI gateways	PROFINET PROFI-safe ²⁾
Integration via Flexi Soft safety controller	CANopen, DeviceNet™, EtherCAT®, EtherNet/IP™, Modbus TCP, PROFIBUS DP, PROFINET ³⁾

¹⁾ Depending on load, power supply and wire cross-section. The technical specifications must be observed.

²⁾ For a suitable EFI-gateway see modules and gateways in the accessory section of connection systems.

³⁾ For additional information on Flexi Soft → www.sick.com/Flexi_Soft

Electrical data

Protection class	III (IEC 61140)
Supply voltage V_s	24 V DC (19.2 V ... 28.8 V) ¹⁾
Residual ripple	≤ 10 % ²⁾
Output signal switching devices (OSSDs)	
Type of output	2 PNP semiconductors, short-circuit protected, cross-circuit monitored ³⁾
ON state, switching voltage HIGH	24 V DC ($V_s - 2.25$ V DC ... V_s)
OFF state, switching voltage LOW	≤ 2 V DC
Current-carrying capacity per OSSD	≤ 500 mA
Application diagnostic output (ADO)	
Type of output	PNP semiconductor, short-circuit protected ³⁾
Output voltage HIGH (active)	24 V DC ($V_s - 4.2$ V DC ... V_s)
Output voltage LOW (deactivated)	High resistance
Output current HIGH (active)	≤ 100 mA

¹⁾ The external voltage supply must be capable of buffering brief mains voltage failures of 20 ms as specified in EN 60204-1. Suitable power supplies are available as accessories from SICK.

²⁾ Within the limits of V_s .

³⁾ Applies to the voltage range between -30 V and +30 V.

Mechanical data

Dimensions	See dimensional drawing
Housing cross-section	48 mm x 40 mm
Housing material	Aluminum extruded profile

Ambient data

Enclosure rating	IP65 (EN 60529)
Ambient operating temperature	0 °C ... +55 °C
Storage temperature	-25 °C ... +70 °C
Air humidity	15 % ... 95 %, Non-condensing
Vibration resistance	5 g, 10 Hz ... 55 Hz (EN 60068-2-6)
Shock resistance	10 g, 16 ms (EN 60068-2-27)

Other information

Wave length	950 nm
Type of light	Near-infrared (NIR), invisible

Ordering information

Resolution	Scanning range	Protective field height	Sender		Receiver	
			Type	Part no.	Type	Part no.
14 mm	10 m	450 mm	C40S-S144	1071158	C40E-S144	1071159
		1,800 mm	C40S-S136	1063412	C40E-S136	1063413
30 mm	21 m	900 mm	C40S-S114	1050298	C40E-S116	1050537
		1,500 mm	C40S-S005	1024072	C40E-S138	1064892
		1,800 mm	C40S-S124	1051138	C40E-S142	1070016
40 mm	21 m	1,350 mm	C40S-S125	1051371	C40E-S133	1056824

Dimensional drawing (Dimensions in mm (inch))

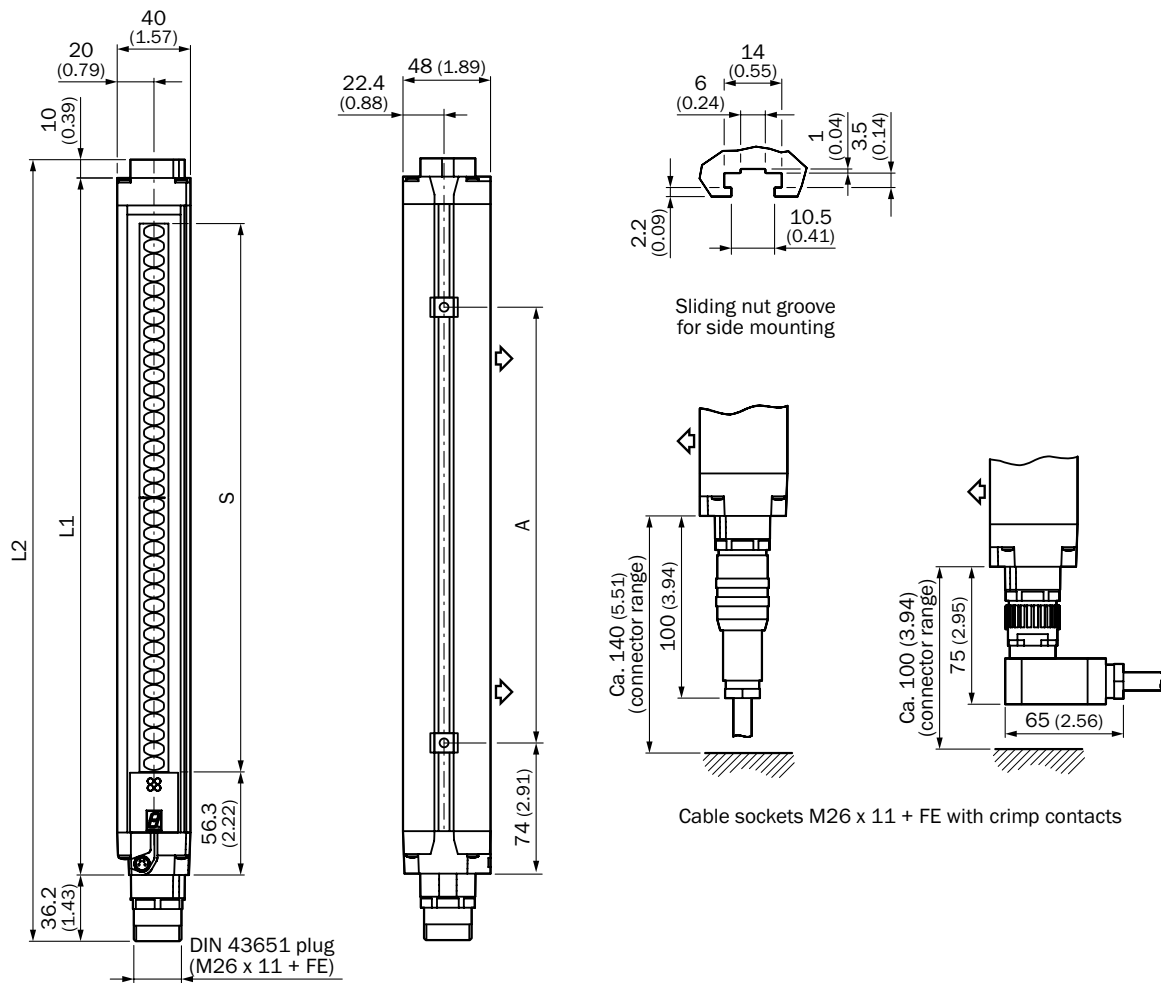



Illustration sender (receiver mirror image)

Protective field height S	L1	L2	A
450 (17.72)	532 (20.94)	578 (22.76)	374 (14.72)
900 (35.43)	984 (38.74)	1,030 (40.55)	824 (32.44)
1,350 (53.15)	1,435 (56.50)	1,481 (58.31)	1,274 (50.16)
1,500 (59.05)	1,586 (62.44)	1,632 (64.25)	1,424 (56.06)
1,800 (70.87)	1,887 (74.29)	1,933 (76.10)	1,724 (67.87)

Recommended accessories







Mounting systems

Mounting brackets and plates

Figure	Description	Packing unit	Type	Part no.
	Mounting kit 1, mounting bracket, rigid, L-shaped, including fixing screws and washers	4 pieces	BEF-3WNGBAST4	7021352
	Mounting kit 11, exchangeable retainer, suitable for replacement of FGS	4 pieces	BEF-3WNGBCST4	2021646

Terminal and alignment brackets

Alignment brackets

Figure	Description	Packing unit	Type	Part no.
	Mounting kit 2, rotatable, swivel mount, Polyamide PA6	4 pieces	BEF-2SMMEAKU4	2019659
	Mounting kit 3, rotatable, with shock-absorber	4 pieces	BEF-1SHADAAL4	2017752
	Mounting kit 6, side bracket, rotatable, Zinc diecast	4 pieces	BEF-1SHABAZN4	2019506
	Mounting kit, rotatable, telescopic, swivel mount, Polyamide PA6	2 pieces	BEF-0SMMEA002	2046172
	Omega bracket, rotatable, fixable with only one screw, for mounting on the swivel mount	4 pieces	BEF-2SMMEAAL4	2044847
	Reinforced stainless steel bracket, rotatable, stainless steel 1.4350, stainless steel 1.4301	4 pieces	BEF-2SMMVAES4	2026850
	Stainless steel bracket, rotatable, stainless steel 1.4350, stainless steel 1.4301	4 pieces	BEF-2SMMEAES4	2023708

Other mounting accessories

Sliding nuts

Figure	Description	Packing unit	Type	Part no.
	Sliding nut set, M5, 4x, Included in delivery	4 pieces	Sliding nuts	2017550
 Illustration may differ	Suitable for PNS75 and PNS125	6 pieces	Sliding nuts for deflector mirror	2030600

Connection systems

Plug connectors and cables

Cables (ready to assemble)



Figure	Description	Model	Conductor cross-section	Number of cores	Items supplied	Type	Part no.
	max. 100 m, fitting for EFI connections	PVC, unshielded	0.75 mm ²	12-wire	By the meter	Connecting cable	6021437

Connecting cables

- **Model:** PVC, unshielded

Figure	Connection type		Description	Conductor cross-section	Length of cable	Type	Part no.	
	Female connector, M26, 12-pin, straight	Flying leads	-	0.75 mm ²	2.5 m	DOL-0612G2M5075KM0	2022544	
					5 m	DOL-0612G05M075KM0	2022545	
					7.5 m	DOL-0612G7M5075KM0	2022546	
					10 m	DOL-0612G10M075KM0	2022547	
					15 m	DOL-0612G15M075KM0	2022548	
					20 m	DOL-0612G20M075KM0	2022549	
					30 m	DOL-0612G30M075KM0	2022550	
					50 m	DOL-0612G50M075KM0	2033548	
				0.75 mm ²	Without EFI: Pin 9 and 10 not connected	5 m	DOL-0610G05M075KM1	2046888
						7.5 m	DOL-0610G7M5075KM5	2044042
						10 m	DOL-0610G10M075KM1	2046889
						20 m	DOL-0610G20M075KM1	2046890

Field-attachable connectors

Figure	Connection type	Permitted cross-section	Permitted cable diameter	Type	Part no.
	Female connector, M26, 12-pin, straight, crimp contacts	0.5 mm ² ... 1.5 mm ²	8 mm ... 10 mm	DOS-0612G000GA3KM0	6020757
	Female connector, M26, 12-pin, angled, crimp contacts	0.5 mm ² ... 1.5 mm ²	8 mm ... 10 mm	DOS-0612W000GA3KM0	6020758
	Male connector, M26, 12-pin, straight, crimp contacts	0.5 mm ² ... 1.5 mm ²	8 mm ... 10 mm	STE-0612G000GA3KM0	6021191
	Male connector, M26, 12-pin, angled, crimp contacts	0.5 mm ² ... 1.5 mm ²	8 mm ... 10 mm	STE-0612W000GA3KM0	6021192

Connection cables

- **Model:** PVC, unshielded

Figure	Connection type		Conductor cross-section	Length of cable	Type	Part no.
	Male connector, M8, 4-pin, straight	Male connector, USB-A, straight	0.25 mm ²	2 m	DSL-8U04G02M025KM1	6034574
				10 m	DSL-8U04G10M025KM1	6034575



Modules and gateways

EFI gateways

Figure	Description	Type	Part no.
	PROFINET PROFIsafe	UE4740-22H0000	1046978

Reflectors and optics

Alignment aids

Figure	Description	Type	Part no.
	Laser alignment aid for various sensors, laser class 2 (IEC 60825). Do not look into the beam!	AR60	1015741
	Adapter AR60 for housing cross-section 48 mm x 40 mm	AR60 adapter, 48x40	4032461
 <small>Illustration may differ</small>	Adapter AR60 for housing cross-section 48 mm x 40 mm in PU3H device column	AR60 adapter, 48x40, PU3H	4056731

Optics cloths

Figure	Description	Type	Part no.
	Cloth for cleaning optical surfaces	Lens cloth	4003353

Further accessories

Test and monitoring tools

Figure	Description	Type	Part no.
	14 mm diameter	Test rod 14 mm	2022599
	30 mm diameter	Test rod 30 mm	2022602
	40 mm diameter	Test rod 40 mm	2022604

Cleaning agent

Figure	Description	Type	Part no.
	Plastic cleaner and care product, anti-static, 0.5 liter	Plastic cleaner	5600006

Safety relays

Switching amplifiers

Figure	Description	Type	Part no.
 Illustration may differ	UE402 switching amplifier	UE402	1023577

TOTAL FLEXIBILITY – EVEN IN EXPLOSIVE ATMOSPHERES

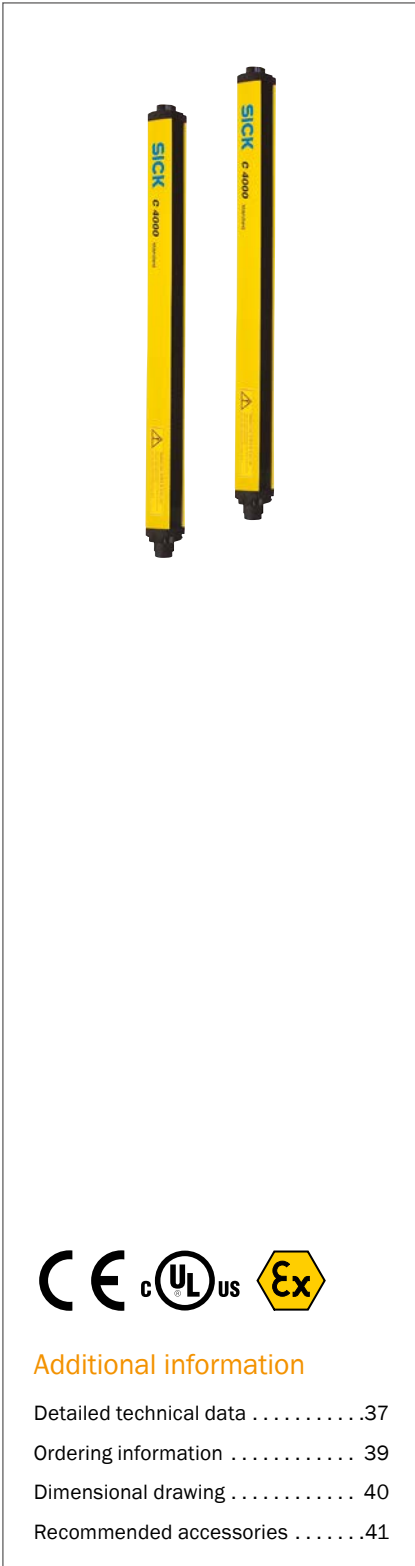

Product description

The C4000 Fusion ATEX II 3G/3D safety light curtain is a cost-effective, reliable solution that safeguards hazardous points and areas, even in potentially explosive atmospheres. Functions such as the restart interlock and external device monitoring provide easy machine integration. Various mounting adapters

and innovative accessories enable flexible installation. The industry-tested 7-segment display saves time during alignment and diagnostics. Plus, the C4000 Fusion ATEX II 3G/3D safeguards hazardous points in explosion-hazardous areas with a protective field height of up to 1,800 mm.

At a glance

- Type 4 (IEC 61496), SIL3 (IEC 61508), PL e (EN ISO 13849)
- ATEX II 3G/3D (2/22 zones)
- ATEX for gas: II 3G Ex nA op is IIC T4 Gc X
- ATEX for dust: II 3D Ex tc IIIC T135°C Dc
- 7-segment display
- External device monitoring (EDM) and restart interlock
- Beam coding for accurate system allocation
- Configuration and diagnostics via PC

Your benefits

- ATEX II 3G/3D for use in 2/22 zones
- Large scanning ranges up to 21 m and sufficient power reserve for use in paint finishing lines, for example
- Time-saving alignment and diagnostics by means of 7-segment display
- Beam coding protects the systems against mutual interference and thus offers a high level of availability
- Quick and easy commissioning by means of pre-configuration of the systems or clone plug
- Convenient configuration and diagnostics ensure increased availability



Additional information

Detailed technical data37
 Ordering information 39
 Dimensional drawing 40
 Recommended accessories41

→ www.sick.com/C4000_Fusion_ATEX_II_3G_3D

For more information, simply enter the link or scan the QR code and get direct access to technical data, CAD design models, operating instructions, software, application examples, and much more.



Detailed technical data

Features

Application	Explosive areas
Ex-approvals	ATEX for gas: II 3G Ex nA op is IIC T4 Gc X ATEX for dust: II 3D Ex tc IIIC T135°C Dc
Resolution	20 mm
Protective field height	600 mm ... 1,800 mm (depending on type)
Scanning range	21 m
Synchronization	Optical synchronisation
Integrated laser alignment aid	✓

Safety-related parameters

Type	Type 4 (IEC 61496-1)
Safety integrity level	SIL3 (IEC 61508) SILCL3 (EN 62061)
Category	Category 4 (EN ISO 13849)
Performance level	PL e (EN ISO 13849)
PFH _D (mean probability of a dangerous failure per hour)	15 x 10 ⁻⁹ (EN ISO 13849)
T _M (mission time)	20 years (EN ISO 13849)
Safe state in the event of a fault	At least one OSSD is in the OFF state.

Functions

	Functions	Delivery status
Protective operation	✓	
Restart interlock	✓	Internal
External device monitoring (EDM)	✓	Deactivated
Beam coding	✓	Code 1
Configurable scanning range	✓	
Reduced resolution	✓	Deactivated
Fixed blanking	✓	Deactivated
Floating blanking	✓	Deactivated
Dynamic blanking for object pattern recognition	✓	
Self-teach dynamic blanking for goods detection	✓	
Self-teach dynamic blanking for pallet detection	✓	
Multiple sampling	✓	2x evaluation
Direction monitoring	✓	
Virtual photoelectric switches	✓	
Sensor gap monitoring	✓	
Sequence monitoring	✓	
Object entry monitoring	✓	
Detection of geometrically even objects	✓	
Safe SICK device communication via EFI	✓	

Functions in combination with UE402

Bypass	✓
Operating mode switching	✓

Interfaces

System connection	
Connection type	Hirschmann male connector M26, 12-pin
Permitted cable length	50 m ¹⁾
Conductor cross-section	0.75 mm ²
Configuration connection	
Connection type	Female connector M8, 4-pin
Configuration method	PC with CDS (Configuration and Diagnostic Software)
Display elements	7-segment display
Fieldbus, industrial network	
Integration via EFI gateways	PROFINET PROFIsafe ²⁾
Integration via Flexi Soft safety controller	CANopen, DeviceNet™, EtherCAT®, EtherNet/IP™, Modbus TCP, PROFIBUS DP, PROFINET ³⁾

¹⁾ Depending on load, power supply and wire cross-section. The technical specifications must be observed.

²⁾ For a suitable EFI-gateway see modules and gateways in the accessory section of connection systems.

³⁾ For additional information on Flexi Soft → www.sick.com/Flexi_Soft

Electrical data

Protection class	III (IEC 61140)
Supply voltage V_s	24 V DC (19.2 V ... 28.8 V) ¹⁾
Residual ripple	≤ 10 % ²⁾
Output signal switching devices (OSSDs)	
Type of output	2 PNP semiconductors, short-circuit protected, cross-circuit monitored ³⁾
ON state, switching voltage HIGH	24 V DC ($V_s - 2.25$ V DC ... V_s)
OFF state, switching voltage LOW	≤ 2 V DC
Current-carrying capacity per OSSD	≤ 500 mA
Application diagnostic output (ADO)	
Type of output	PNP semiconductor, short-circuit protected ³⁾
Output voltage HIGH (active)	24 V DC (15 V DC ... 28.8 V DC)
Output voltage LOW (deactivated)	High resistance
Output current HIGH (active)	≤ 100 mA

¹⁾ The external voltage supply must be capable of buffering brief mains voltage failures of 20 ms as specified in EN 60204-1. Suitable power supplies are available as accessories from SICK.

²⁾ Within the limits of V_s .

³⁾ Applies to the voltage range between -30 V and +30 V.

Mechanical data

Dimensions	See dimensional drawing
Housing cross-section	48 mm x 40 mm
Housing material	Aluminum extruded profile

Ambient data

Enclosure rating	IP65 (EN 60529)
Ambient operating temperature	0 °C ... +55 °C
Storage temperature	-25 °C ... +70 °C
Air humidity	15 % ... 95 %, Non-condensing
Vibration resistance	5 g, 10 Hz ... 55 Hz (EN 60068-2-6)
Shock resistance	10 g, 16 ms (EN 60068-2-27)

Other information

Wave length	950 nm
Type of light	Near-infrared (NIR), invisible
Integrated laser alignment aid	✓
Laser class	1
Wave length	650 nm
Type of light	Visible red light

Ordering information

Resolution	Scanning range	Protective field height	Sender		Receiver	
			Type	Part no.	Type	Part no.
20 mm	21 m	600 mm	C40S-S139	1065840	C40E-S139	1065841
		750 mm	C40S-S145	1081732	C40E-S145	1081733
		900 mm	C40S-S146	1081931	C40E-S146	1081932
		1,050 mm	C40S-S131	1054690	C40E-S131	1054691
		1,350 mm	C40S-S147	1082907	C40E-S147	1082908
		1,800 mm	C40S-S135	1063410	C40E-S135	1063411

Dimensional drawing (Dimensions in mm (inch))

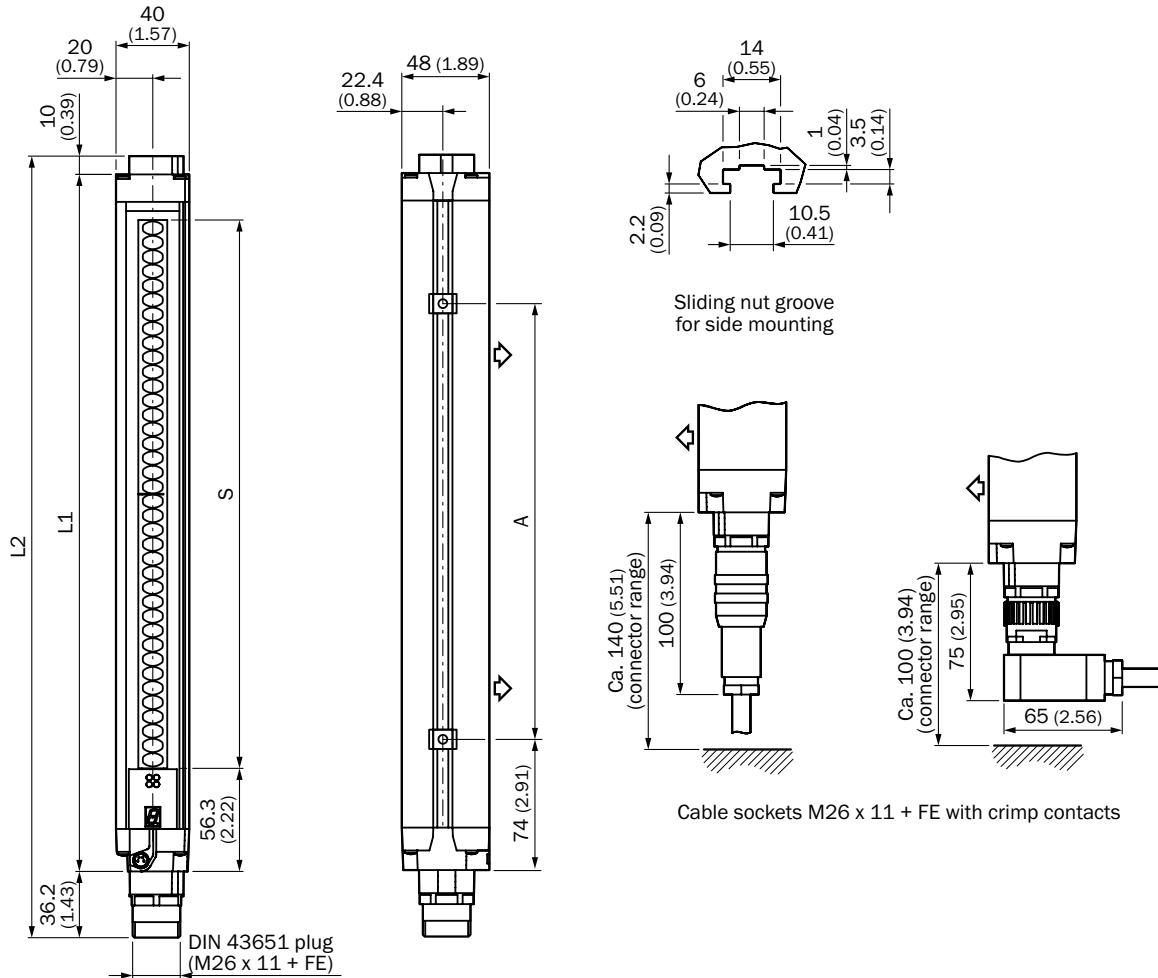



Illustration sender (receiver mirror image)

Protective field height S	L1	L2	A
600 (23.62)	682 (26.85)	728 (28.66)	524 (20.63)
750 (29.53)	833 (32.80)	879 (34.61)	674 (26.54)
900 (35.43)	984 (38.74)	1.030 (40.55)	824 (32.44)
1,050 (41.34)	1,134 (44.65)	1,180 (46.46)	974 (38.35)
1,350 (53.15)	1,435 (56.50)	1,481 (58.31)	1,274 (50.16)
1,800 (70.87)	1,887 (74.29)	1,933 (76.10)	1,724 (67.87)

Recommended accessories







Mounting systems

Mounting brackets and plates

Figure	Description	Packing unit	Type	Part no.
	Mounting kit 1, mounting bracket, rigid, L-shaped, including fixing screws and washers	4 pieces	BEF-3WNGBAST4	7021352
	Mounting kit 11, exchangeable retainer, suitable for replacement of FGS	4 pieces	BEF-3WNGBCST4	2021646

Terminal and alignment brackets

Alignment brackets

Figure	Description	Packing unit	Type	Part no.
	Mounting kit 2, rotatable, swivel mount, Polyamide PA6	4 pieces	BEF-2SMMEAKU4	2019659
	Mounting kit 3, rotatable, with shock-absorber	4 pieces	BEF-1SHADAAL4	2017752
	Mounting kit 6, side bracket, rotatable, Zinc diecast	4 pieces	BEF-1SHABAZN4	2019506
	Mounting kit, rotatable, telescopic, swivel mount, Polyamide PA6	2 pieces	BEF-0SMMEA002	2046172
	Omega bracket, rotatable, fixable with only one screw, for mounting on the swivel mount	4 pieces	BEF-2SMMEAAL4	2044847
	Reinforced stainless steel bracket, rotatable, stainless steel 1.4350, stainless steel 1.4301	4 pieces	BEF-2SMMVAES4	2026850
	Stainless steel bracket, rotatable, stainless steel 1.4350, stainless steel 1.4301	4 pieces	BEF-2SMMEAES4	2023708

Other mounting accessories

Sliding nuts

Figure	Description	Packing unit	Type	Part no.
	Sliding nut set, M5, 4x, Included in delivery	4 pieces	Sliding nuts	2017550
 Illustration may differ	Suitable for PNS75 and PNS125	6 pieces	Sliding nuts for deflector mirror	2030600

Stands

Figure	Description	Packing unit	Type	Part no.
	Floor stands for the horizontal mounting of the safety light curtains C4000 Fusion, Entry/Exit, Palletizer, as well as the multi-beam safety light curtain M4000 Area, for mounting heights of between 70 mm and 780 mm., Includes mounting bracket	2 pieces	BEF-3HHOCAST2	2041661

Connection systems

Plug connectors and cables

Cables (ready to assemble)

Figure	Description	Model	Conductor cross-section	Number of cores	Items supplied	Type	Part no.
	max. 100 m, fitting for EFI connections	PVC, unshielded	0.75 mm ²	12-wire	By the meter	Connecting cable	6021437

Connecting cables

- **Model:** PVC, unshielded

Figure	Connection type	Description	Conductor cross-section	Length of cable	Type	Part no.
	Flying leads	-	0.75 mm ²	2.5 m	DOL-0612G2M5075KM0	2022544
				5 m	DOL-0612G05M075KM0	2022545
				7.5 m	DOL-0612G7M5075KM0	2022546
				10 m	DOL-0612G10M075KM0	2022547
				15 m	DOL-0612G15M075KM0	2022548
				20 m	DOL-0612G20M075KM0	2022549
				30 m	DOL-0612G30M075KM0	2022550
		Without EFI: Pin 9 and 10 not connected	0.75 mm ²	5 m	DOL-0610G05M075KM1	2046888
				7.5 m	DOL-0610G7M5075KM5	2044042
				10 m	DOL-0610G10M075KM1	2046889
				20 m	DOL-0610G20M075KM1	2046890

Field-attachable connectors

Figure	Connection type	Permitted cross-section	Permitted cable diameter	Type	Part no.
	Female connector, M26, 12-pin, straight, crimp contacts	0.5 mm ² ... 1.5 mm ²	8 mm ... 10 mm	DOS-0612G000GA3KM0	6020757
	Female connector, M26, 12-pin, angled, crimp contacts	0.5 mm ² ... 1.5 mm ²	8 mm ... 10 mm	DOS-0612W000GA3KM0	6020758
	Male connector, M26, 12-pin, straight, crimp contacts	0.5 mm ² ... 1.5 mm ²	8 mm ... 10 mm	STE-0612G000GA3KM0	6021191
	Male connector, M26, 12-pin, angled, crimp contacts	0.5 mm ² ... 1.5 mm ²	8 mm ... 10 mm	STE-0612W000GA3KM0	6021192

Connection cables

- **Model:** PVC, unshielded

Figure	Connection type		Conductor cross-section	Length of cable	Type	Part no.
	Male connector, M8, 4-pin, straight	Male connector, USB-A, straight	0.25 mm ²	2 m	DSL-8U04G02M025KM1	6034574
				10 m	DSL-8U04G10M025KM1	6034575



Modules and gateways

EFI gateways

Figure	Description	Type	Part no.
	PROFINET PROFI-safe	UE4740-22H0000	1046978

Reflectors and optics

Alignment aids

Figure	Description	Type	Part no.
	Laser alignment aid for various sensors, laser class 2 (IEC 60825). Do not look into the beam!	AR60	1015741
	Adapter AR60 for housing cross-section 48 mm x 40 mm	AR60 adapter, 48x40	4032461
 Illustration may differ	Adapter AR60 for housing cross-section 48 mm x 40 mm in PU3H device column	AR60 adapter, 48x40, PU3H	4056731

Optics cloths

Figure	Description	Type	Part no.
	Cloth for cleaning optical surfaces	Lens cloth	4003353

Further accessories

Test and monitoring tools

Figure	Description	Type	Part no.
	20 mm diameter	Test rod 20 mm	2022600

Cleaning agent

Figure	Description	Type	Part no.
	Plastic cleaner and care product, anti-static, 0.5 liter	Plastic cleaner	5600006

Safety relays

Switching amplifiers

Figure	Description	Type	Part no.
 Illustration may differ	UE402 switching amplifier	UE402	1023577

TOTAL FLEXIBILITY – EVEN IN EXPLOSIVE ATMOSPHERES

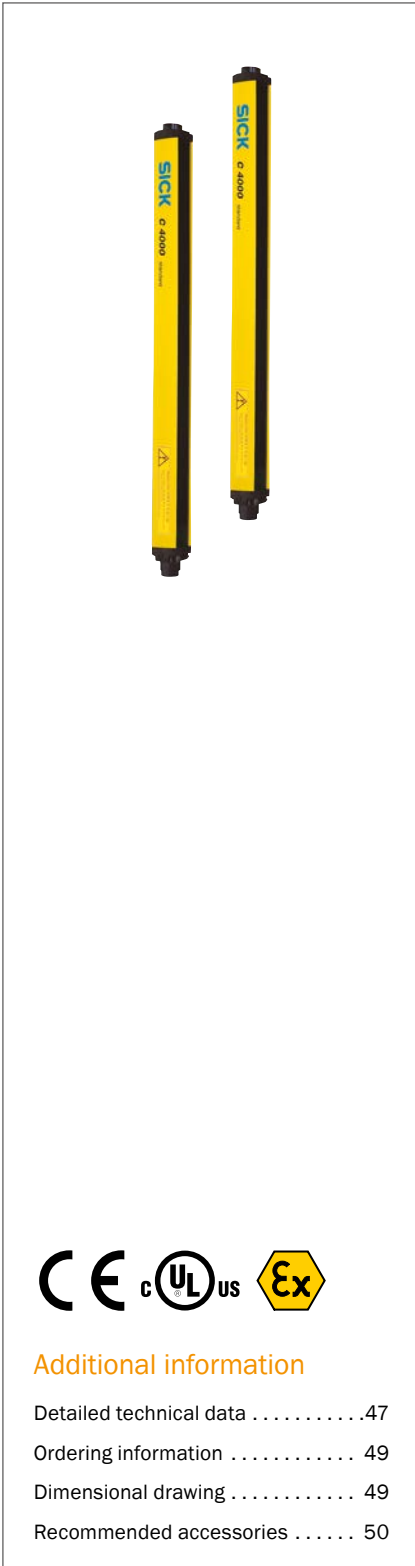

Product description

The C4000 Entry/Exit ATEX II 3G/3D safety light curtain is a cost-effective, reliable solution that safeguards hazardous points and areas, even in potentially explosive atmospheres. Functions such as the restart interlock and external device monitoring provide easy machine integration. Various mounting

adapters and innovative accessories enable flexible installation. The industry-tested 7-segment display saves time during alignment and diagnostics. Plus, the C4000 Entry/Exit ATEX II 3G/3D safeguards hazardous points in explosion-hazardous area with a protective field height of up to 1800 mm.

At a glance

- Type 4 (IEC 61496), SIL3 (IEC 61508), PL e (EN ISO 13849)
- ATEX II 3G/3D (2/22 zones)
- ATEX for gas: II 3G Ex nA op is IIC T4 Gc X
- ATEX for dust: II 3D Ex tc IIIC T135°C Dc
- 7-segment display
- External device monitoring (EDM) and restart interlock
- Beam coding for accurate system allocation
- Configuration and diagnostics via PC

Your benefits

- ATEX II 3G/3D for use in 2/22 zones
- Large scanning ranges up to 21 m and sufficient power reserve for use in paint finishing lines, for example
- Time-saving alignment and diagnostics by means of 7-segment display
- Beam coding protects the systems against mutual interference and thus offers a high level of availability
- Quick and easy commissioning by means of pre-configuration of the systems or clone plug
- Convenient configuration and diagnostics ensure increased availability



Additional information

Detailed technical data	47
Ordering information	49
Dimensional drawing	49
Recommended accessories	50

→ www.sick.com/C4000_Entry_Exit_ATEX_II_3G_3D

For more information, simply enter the link or scan the QR code and get direct access to technical data, CAD design models, operating instructions, software, application examples, and much more.



Detailed technical data

Features

Application	Explosive areas, Explosive areas
Ex-approvals	ATEX for gas: II 3G Ex nA op is IIC T4 Gc X ATEX for dust: II 3D Ex tc IIIC T135°C Dc
Resolution	20 mm
Protective field height	900 mm
Scanning range	21 m
Synchronization	Optical synchronisation

Safety-related parameters

Type	Type 4 (IEC 61496-1)
Safety integrity level	SIL3 (IEC 61508) SILCL3 (EN 62061)
Category	Category 4 (EN ISO 13849)
Performance level	PL e (EN ISO 13849)
PFH_d (mean probability of a dangerous failure per hour)	15 x 10 ⁻⁹ (EN ISO 13849)
T_M (mission time)	20 years (EN ISO 13849)
Safe state in the event of a fault	At least one OSSD is in the OFF state.

Functions

	Functions	Delivery status
Protective operation	✓	
Restart interlock	✓	Internal
External device monitoring (EDM)	✓	Deactivated
Beam coding	✓	Code 1
Configurable scanning range	✓	
Dynamic blanking for object pattern recognition	✓	
Safe SICK device communication via EFI	✓	

Functions in combination with UE402

Bypass	✓
Operating mode switching	✓

Interfaces

System connection	
Connection type	Hirschmann male connector M26, 12-pin
Permitted cable length	50 m ¹⁾
Conductor cross-section	0.75 mm ²
Configuration connection	
Connection type	Female connector M8, 4-pin
Configuration method	PC with CDS (Configuration and Diagnostic Software)
Display elements	7-segment display

¹⁾ Depending on load, power supply and wire cross-section. The technical specifications must be observed.

²⁾ For a suitable EFI-gateway see modules and gateways in the accessory section of connection systems.

³⁾ For additional information on Flexi Soft → www.sick.com/Flexi_Soft

Fieldbus, industrial network	
Integration via EFI gateways	PROFINET PROFIsafe ²⁾
Integration via Flexi Soft safety controller	CANopen, DeviceNet™, EtherCAT®, EtherNet/IP™, Modbus TCP, PROFIBUS DP, PROFINET ³⁾

¹⁾ Depending on load, power supply and wire cross-section. The technical specifications must be observed.

²⁾ For a suitable EFI-gateway see modules and gateways in the accessory section of connection systems.

³⁾ For additional information on Flexi Soft → www.sick.com/Flexi_Soft

Electrical data

Protection class	III (IEC 61140)
Supply voltage V_s	24 V DC (19.2 V ... 28.8 V) ¹⁾
Residual ripple	≤ 10 % ²⁾
Output signal switching devices (OSSDs)	
Type of output	2 PNP semiconductors, short-circuit protected, cross-circuit monitored ³⁾
ON state, switching voltage HIGH	24 V DC ($V_s - 2.25$ V DC ... V_s)
OFF state, switching voltage LOW	≤ 2 V DC
Current-carrying capacity per OSSD	≤ 500 mA
Application diagnostic output (ADO)	
Type of output	PNP semiconductor, short-circuit protected ³⁾
Output voltage HIGH (active)	24 V DC ($V_s - 4.2$ V DC ... V_s)
Output voltage LOW (deactivated)	High resistance
Output current HIGH (active)	≤ 100 mA

¹⁾ The external voltage supply must be capable of buffering brief mains voltage failures of 20 ms as specified in EN 60204-1. Suitable power supplies are available as accessories from SICK.

²⁾ Within the limits of V_s .

³⁾ Applies to the voltage range between -30 V and +30 V.

Mechanical data

Dimensions	See dimensional drawing
Housing cross-section	48 mm x 40 mm
Housing material	Aluminum extruded profile

Ambient data

Enclosure rating	IP65 (EN 60529)
Ambient operating temperature	0 °C ... +55 °C
Storage temperature	-25 °C ... +70 °C
Air humidity	15 % ... 95 %, Non-condensing
Vibration resistance	5 g, 10 Hz ... 55 Hz (EN 60068-2-6)
Shock resistance	10 g, 16 ms (EN 60068-2-27)

Other information

Wave length	950 nm
Type of light	Near-infrared (NIR), invisible

Ordering information

Resolution	Scanning range	Protective field height	Sender		Receiver	
			Type	Part no.	Type	Part no.
20 mm	21 m	900 mm	C40S-S129	1053721	C40E-S129	1053722

Dimensional drawing (Dimensions in mm (inch))

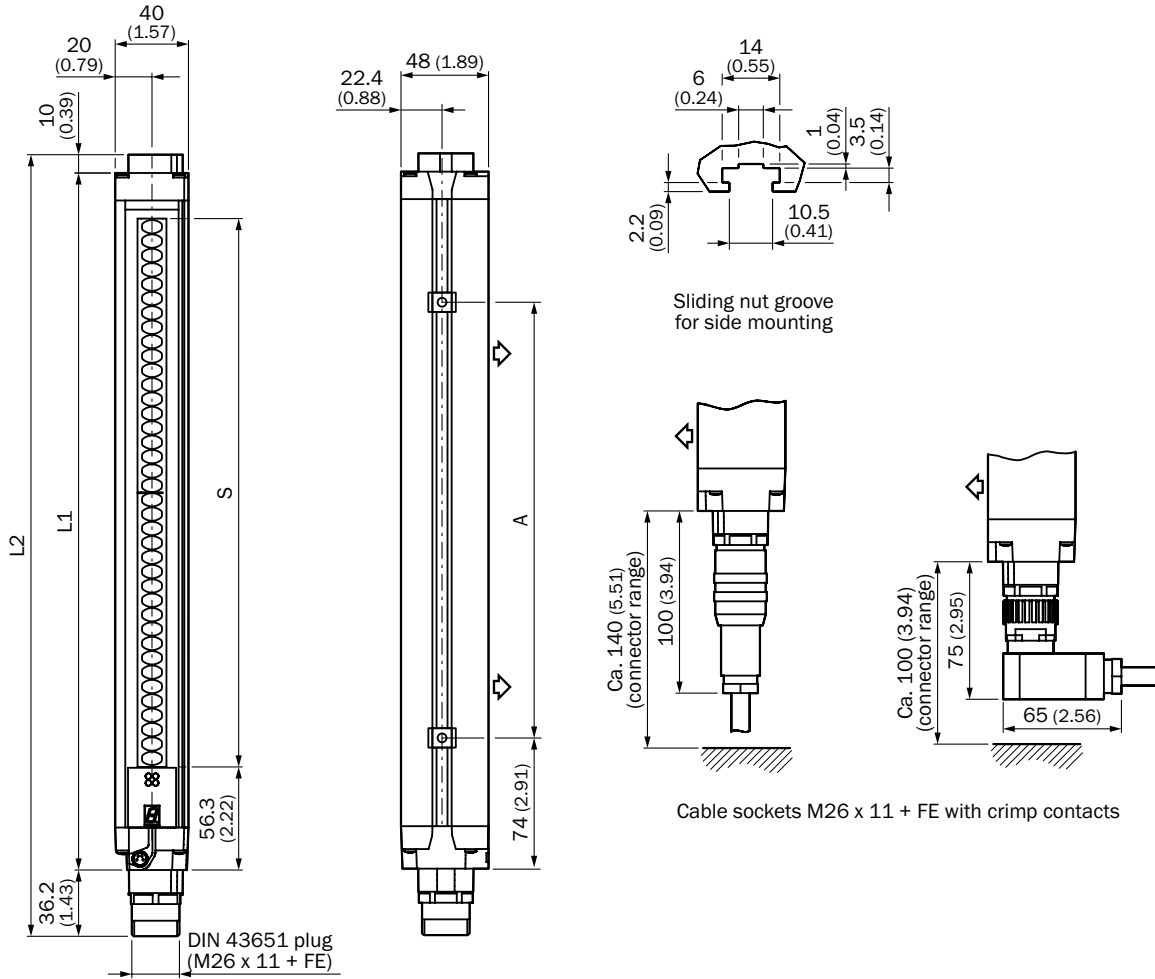



Illustration sender (receiver mirror image)

Protective field height S	L1	L2	A
900 (35.43)	984 (38.74)	1,030 (40.55)	824 (32.44)

Recommended accessories





Mounting systems

Mounting brackets and plates

Figure	Description	Packing unit	Type	Part no.
	Mounting kit 1, mounting bracket, rigid, L-shaped, including fixing screws and washers	4 pieces	BEF-3WNGBAST4	7021352

Terminal and alignment brackets

Alignment brackets

Figure	Description	Packing unit	Type	Part no.
	Mounting kit 2, rotatable, swivel mount, Polyamide PA6	4 pieces	BEF-2SMMEAKU4	2019659
	Mounting kit 3, rotatable, with shock-absorber	4 pieces	BEF-1SHADAAL4	2017752
	Mounting kit 6, side bracket, rotatable, Zinc diecast	4 pieces	BEF-1SHABAZN4	2019506
	Omega bracket, rotatable, fixable with only one screw, for mounting on the swivel mount	4 pieces	BEF-2SMMEAL4	2044847
	Reinforced stainless steel bracket, rotatable, stainless steel 1.4350, stainless steel 1.4301	4 pieces	BEF-2SMMVAES4	2026850

Other mounting accessories

Sliding nuts

Figure	Description	Packing unit	Type	Part no.
	Sliding nut set, M5, 4x, Included in delivery	4 pieces	Sliding nuts	2017550

Connection systems

Plug connectors and cables

Cables (ready to assemble)

Figure	Description	Model	Conductor cross-section	Number of cores	Items supplied	Type	Part no.
	max. 100 m, fitting for EFI connections	PVC, unshielded	0.75 mm ²	12-wire	By the meter	Connecting cable	6021437

Connecting cables

- **Model:** PVC, unshielded

Figure	Connection type		Description	Conductor cross-section	Length of cable	Type	Part no.
	Female connector, M26, 12-pin, straight	Flying leads	-	0.75 mm ²	2.5 m	DOL-0612G2M5075KM0	2022544
					5 m	DOL-0612G05M075KM0	2022545
					7.5 m	DOL-0612G7M5075KM0	2022546
					10 m	DOL-0612G10M075KM0	2022547
					15 m	DOL-0612G15M075KM0	2022548
					20 m	DOL-0612G20M075KM0	2022549
					30 m	DOL-0612G30M075KM0	2022550
		Without EFI: Pin 9 and 10 not connected	0.75 mm ²	5 m	DOL-0610G05M075KM1	2046888	
				7.5 m	DOL-0610G7M5075KM5	2044042	
				10 m	DOL-0610G10M075KM1	2046889	
				20 m	DOL-0610G20M075KM1	2046890	

Field-attachable connectors

Figure	Connection type	Permitted cross-section	Permitted cable diameter	Type	Part no.
	Female connector, M26, 12-pin, straight, crimp contacts	0.5 mm ² ... 1.5 mm ²	8 mm ... 10 mm	DOS-0612G000GA3KM0	6020757
	Female connector, M26, 12-pin, angled, crimp contacts	0.5 mm ² ... 1.5 mm ²	8 mm ... 10 mm	DOS-0612W000GA3KM0	6020758

Connection cables

- **Model:** PVC, unshielded

Figure	Connection type		Conductor cross-section	Length of cable	Type	Part no.
	Male connector, M8, 4-pin, straight	Male connector, USB-A, straight	0.25 mm ²	2 m	DSL-8U04G02M025KM1	6034574
				10 m	DSL-8U04G10M025KM1	6034575



Modules and gateways

EFI gateways

Figure	Description	Type	Part no.
	PROFINET PROFI-safe	UE4740-22H0000	1046978

Reflectors and optics

Alignment aids

Figure	Description	Type	Part no.
	Laser alignment aid for various sensors, laser class 2 (IEC 60825). Do not look into the beam!	AR60	1015741
	Adapter AR60 for housing cross-section 48 mm x 40 mm	AR60 adapter, 48x40	4032461
 Illustration may differ	Adapter AR60 for housing cross-section 48 mm x 40 mm in PU3H device column	AR60 adapter, 48x40, PU3H	4056731

Optics cloths

Figure	Description	Type	Part no.
	Cloth for cleaning optical surfaces	Lens cloth	4003353

Further accessories

Test and monitoring tools

Figure	Description	Type	Part no.
	20 mm diameter	Test rod 20 mm	2022600

Cleaning agent

Figure	Description	Type	Part no.
	Plastic cleaner and care product, anti-static, 0.5 liter	Plastic cleaner	5600006

Safety relays

Switching amplifiers

Figure	Description	Type	Part no.
 Illustration may differ	UE402 switching amplifier	UE402	1023577

SAFETY IN EXPLOSIVE ATMOSPHERES

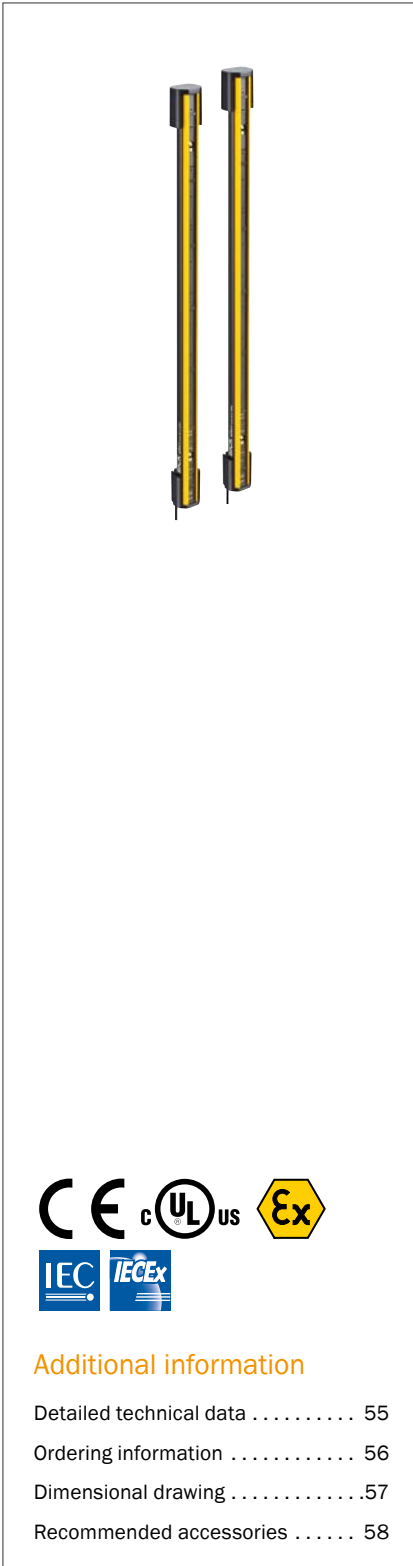

Product description

Rugged and reliable safety technology is very important in industries with explosion-hazardous areas. A single spark can be disastrous. With the special version of the deTem4 Core Ex II 3GD safety multibeam sensor, SICK is ensuring compliance with the high safety requirements in explosive areas. It fulfills the requirements of the ATEX guidelines for use in explosion-hazardous areas (ATEX

for gas: II 3G EX and ATEX for dust: II 3D Ex). Thanks to the high resistance and reliability, the safety multibeam sensor is particularly well-suited for use in tough industrial settings. The deTem4 Core Ex II 3GD offers maximum reliability and very high safety for employees, even in explosive atmospheres.

At a glance

- ATEX for gas: II 3G Ex ec op is IIC T4 Gc
- ATEX for dust: II 3D Ex tc IIIC T135°C Dc
- Innovative bracket
- LED alignment and status display
- Standardized connectivity: M12 male connector, 5-pin connection, compatible with Flexi Loop
- Enclosure ratings: IP65 and IP67

Your benefits

- Uniform housing and accessory concept for standard and special industrial environments saves time and money when planning systems
- Innovative bracket concept for easy mounting saves installation time and costs
- Fast installation thanks to integrated LED display saves time and money
- Standardized connectivity for Flexi Loop integration saves installation time and costs
- Enclosure ratings IP65, IP67 and temperature resistance offer long sensor life times and therefore even more efficiency



→ www.sick.com/deTem4_Core_Ex_II_3GD

For more information, simply enter the link or scan the QR code and get direct access to technical data, CAD design models, operating instructions, software, application examples, and much more.



Detailed technical data

Features

Application	Explosive areas
Ex-approvals	ATEX for gas: II 3G Ex ec op is IIC T4 Gc ATEX for dust: II 3D Ex tc IIIC T135°C Dc
Scanning range	17 m / 90 m (depending on type)
Number of beams	2 / 3 / 4 (depending on type)
Beam separation	500 mm / 400 mm / 300 mm (depending on type)
Response time	20 ms
Synchronization	Optical synchronisation

Safety-related parameters

Type	Type 4 (IEC 61496-1)
Safety integrity level	SIL3 (IEC 61508) SILCL3 (IEC 62061)
Category	Category 4 (ISO 13849-1)
Performance level	PL e (ISO 13849-1)
PFH_D (mean probability of a dangerous failure per hour)	3×10^{-9}
T_M (mission time)	20 years (ISO 13849-1)
Safe state in the event of a fault	At least one OSSD is in the OFF state.

Functions

Protective operation	✓
-----------------------------	---

Interfaces

System connection	
Connection type	Male connector M12, 5-pin
Permitted cable length	≤ 50 m ¹⁾
Status display	LEDs
Fieldbus, industrial network	
Integration via Flexi Soft safety controller	CANopen, DeviceNet™, EtherCAT®, EtherNet/IP™, Modbus TCP, PROFIBUS DP, PROFINET ²⁾

¹⁾ Maximum permissible conductor resistance must be observed.

²⁾ For additional information on Flexi Soft → www.sick.com/Flexi_Soft

Electrical data

Protection class	III (IEC 61140)
Supply voltage V_s	24 V DC (19.2 V DC ... 28.8 V DC) ¹⁾
Residual ripple	≤ 10 % ²⁾
Output signal switching devices (OSSDs)	
Type of output	2 PNP semiconductors, short-circuit protected, cross-circuit monitored ³⁾
ON state, switching voltage HIGH	24 V DC (V _s – 2.25 V DC ... V _s)
OFF state, switching voltage LOW	≤ 2 V DC
Current-carrying capacity per OSSD	≤ 300 mA

¹⁾ The external voltage supply must be capable of buffering brief mains voltage failures of 20 ms as specified in EN 60204-1. Suitable power supplies are available as accessories from SICK.

²⁾ Within the limits of V_s.

³⁾ Applies to the voltage range between –30 V and +30 V.

Mechanical data

Dimensions	See dimensional drawing
Housing cross-section	38.7 mm x 45.6 mm
Housing material	Aluminum extruded profile

Ambient data

Enclosure rating	IP65 (IEC 60529) IP67 (IEC 60529)
Ambient operating temperature	0 °C ... +55 °C
Storage temperature	-30 °C ... +70 °C
Air humidity	15 % ... 95 %, Non-condensing
Vibration resistance	5 g, 10 Hz ... 55 Hz (IEC 60068-2-6)
Shock resistance	10 g, 16 ms (IEC 60068-2-27)

Other information

Wave length	Near-infrared (NIR), invisible
-------------	--------------------------------

Ordering information

Scanning range	Number of beams	Beam separation	Sender		Receiver	
			Type	Part no.	Type	Part no.
17 m	2	500 mm	M4C-SX0250LA10	1092039	M4C-EX02500A10	1092041
	3	400 mm	M4C-SX0340LA10	1092042	M4C-EX03400A10	1092044
	4	300 mm	M4C-SX0430LA10	1092045	M4C-EX04300A10	1092047
90 m	2	500 mm	M4C-SX0250HA10	1092040	M4C-EX02500A10	1092041
	3	400 mm	M4C-SX0340HA10	1092043	M4C-EX03400A10	1092044
	4	300 mm	M4C-SX0430HA10	1092046	M4C-EX04300A10	1092047

Dimensional drawing (Dimensions in mm (inch))

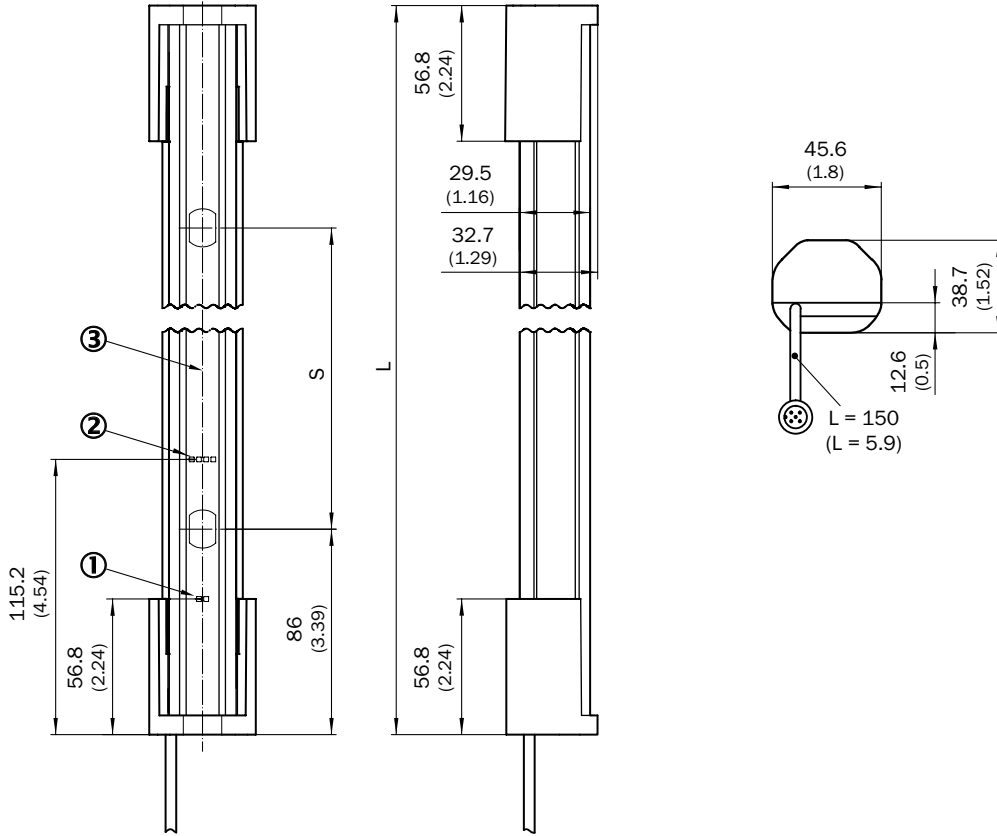



- ① Operating indicator
- ② Alignment indicator
- ③ Optical axis

Number of beams	Beam separation S	Length L
2	500 (19.69)	672 (26.46)
3	400 (15.75)	972 (38.27)
4	300 (11.81)	1,072 (42.2)

Recommended accessories

Mounting systems

Terminal and alignment brackets

Figure	Description	Packing unit	Type	Part no.
	FlexFix mounting kit for 1 device, e.g. sender or receiver (FlexFix bracket, alignment tool and assembly materials for installation in PU3H device columns), plastic	2 pieces	BEF-1SHABBKU2	2073543
	FlexFix bracket for 1 device (e.g. sender or receiver), can be aligned $\pm 15^\circ$, including M5 screw, plastic	2 pieces	BEF-1SHABPKU2	2098709
	FlexFix bracket for 2 devices (e.g. sender and receiver), can be aligned $\pm 15^\circ$, including M5 screw, plastic	4 pieces	BEF-1SHABPKU4	2066614
	QuickFix bracket for 1 device (e.g. sender or receiver), plastic	2 pieces	BEF-3SHABPKU2	2066048
	QuickFix bracket for 2 devices (e.g. sender and receiver), plastic	4 pieces	BEF-3SHABPKU4	2098710

Other mounting accessories

Mounting tools



Figure	Description	Packing unit	Type	Part no.
	Alignment tool for aligning sensors in areas with limited accessibility, e.g. device columns	1 piece	Alignment tool	4084133

Connection systems

Plug connectors and cables

Connecting cables

- **Model:** PUR, halogen-free, unshielded

Figure	Connection type		Conductor cross-section	Length of cable	Type	Part no.
	Female connector, M12, 5-pin, straight	Flying leads	0.34 mm ²	2 m	YF2A15-020UB5XLEAX	2095617
				5 m	YF2A15-050UB5XLEAX	2095618
				10 m	YF2A15-100UB5XLEAX	2095619
				15 m	YF2A15-150UB5XLEAX	2095620
				20 m	YF2A15-200UB5XLEAX	2095614
				30 m	YF2A15-300UB5XLEAX	2095621
	Female connector, M12, 5-pin, angled	Flying leads	0.34 mm ²	2 m	YG2A15-020UB5XLEAX	2095772
				5 m	YG2A15-050UB5XLEAX	2095773
				10 m	YG2A15-100UB5XLEAX	2095774



Adapters and distributors

T-junctions

Figure	Description	Type	Part no.
	T-piece for simultaneous connection to sender and receiver, splits the cable from the control cabinet to the sender and receiver, 5-pin	DSC-1205T000025KM0	6030664

Reflectors and optics

Alignment aids

Figure	Description	Type	Part no.
	Laser alignment aid for various sensors, laser class 2 (IEC 60825). Do not look into the beam!	AR60	1015741
	Adapter AR60 for deTec4, deTec2 and MLG-2	AR60 adapter, deTec, deTem, MLG-2	4070854

Optics cloths

Figure	Description	Type	Part no.
	Cloth for cleaning optical surfaces	Lens cloth	4003353

Further accessories

Test and monitoring tools

Figure	Description	Type	Part no.
	30 mm diameter	Test rod 30 mm	2022602

Cleaning agent

Figure	Description	Type	Part no.
	Plastic cleaner and care product, anti-static, 0.5 liter	Plastic cleaner	5600006

SAFETY IN EXPLOSIVE ATMOSPHERES

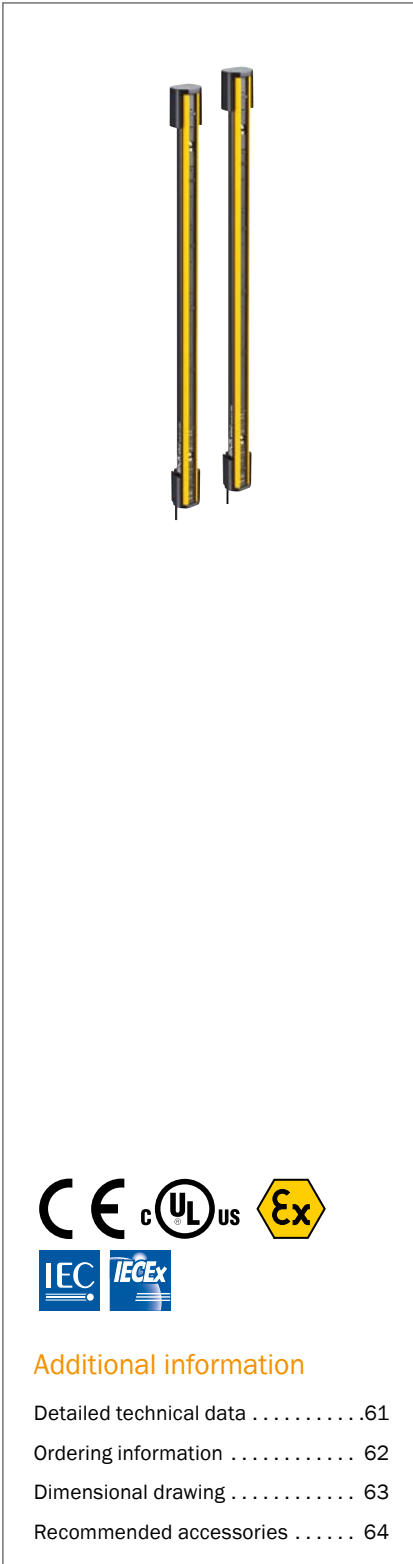

Product description

Rugged and reliable safety technology is very important in industries with explosion-hazardous areas. A single spark can be disastrous. With the special version of the deTem2 Core Ex II 3GD safety multibeam sensor, SICK is ensuring compliance with the high safety requirements in explosive areas. It fulfills the requirements of the ATEX guidelines for use in explosion-hazardous areas (ATEX

for gas: II 3G EX and ATEX for dust: II 3D Ex). Thanks to the high resistance and reliability, the safety multibeam sensor is particularly well-suited for use in tough industrial settings. The deTem2 Core Ex II 3GD offers maximum reliability and very high safety for employees, even in explosive atmospheres.

At a glance

- ATEX for gas: II 3G Ex ec op is IIC T4 Gc
- ATEX for dust: II 3D Ex tc IIIC T135°C Dc
- Innovative bracket
- LED alignment and output display
- Standardized connectivity: M12 male connector, 5-pin connection, compatible with Flexi Loop
- Enclosure ratings: IP65 and IP67

Your benefits

- Uniform housing and accessory concept for standard and special industrial environments saves time and money when planning systems
- Innovative bracket concept for easy mounting saves installation time and costs
- Fast installation thanks to integrated LED display saves time and money
- Standardized connectivity for Flexi Loop integration saves installation time and costs
- Enclosure ratings IP65, IP67 and temperature resistance offer long sensor life times and therefore even more efficiency

→ www.sick.com/deTem2_Core_Ex_II_3GD

For more information, simply enter the link or scan the QR code and get direct access to technical data, CAD design models, operating instructions, software, application examples, and much more.



Detailed technical data

Features

Application	Explosive areas
Ex-approvals	ATEX for gas: II 3G Ex ec op is IIC T4 Gc ATEX for dust: II 3D Ex tc IIIC T135°C Dc
Scanning range	17 m / 90 m (depending on type)
Number of beams	2 / 3 / 4 (depending on type)
Beam separation	500 mm / 400 mm / 300 mm (depending on type)
Response time	20 ms
Synchronization	Optical synchronisation

Safety-related parameters

Type	Type 2 (IEC 61496-1)
Safety integrity level	SIL1 (IEC 61508) SILCL1 (IEC 62061)
Category	Category 2 (ISO 13849-1)
Performance level	PL c (ISO 13849-1)
PFH_D (mean probability of a dangerous failure per hour)	3×10^{-9}
T_M (mission time)	20 years (ISO 13849-1)
Safe state in the event of a fault	At least one OSSD is in the OFF state.

Functions

Protective operation	✓
-----------------------------	---

Interfaces

System connection	
Connection type	Male connector M12, 5-pin
Permitted cable length	≤ 50 m ¹⁾
Status display	LEDs
Fieldbus, industrial network	
Integration via Flexi Soft safety controller	CANopen, DeviceNet™, EtherCAT®, EtherNet/IP™, Modbus TCP, PROFIBUS DP, PROFINET ²⁾

¹⁾ Maximum permissible conductor resistance must be observed.

²⁾ For additional information on Flexi Soft → www.sick.com/Flexi_Soft

Electrical data

Protection class	III (IEC 61140)
Supply voltage V_s	24 V DC (19.2 V DC ... 28.8 V DC) ¹⁾
Residual ripple	≤ 10 % ²⁾
Output signal switching devices (OSSDs)	
Type of output	2 PNP semiconductors, short-circuit protected, cross-circuit monitored ³⁾
ON state, switching voltage HIGH	24 V DC (V _s – 2.25 V DC ... V _s)
OFF state, switching voltage LOW	≤ 2 V DC
Current-carrying capacity per OSSD	≤ 300 mA

¹⁾ The external voltage supply must be capable of buffering brief mains voltage failures of 20 ms as specified in EN 60204-1. Suitable power supplies are available as accessories from SICK.

²⁾ Within the limits of V_s.

³⁾ Applies to the voltage range between –30 V and +30 V.

Mechanical data

Dimensions	See dimensional drawing
Housing cross-section	38.7 mm x 45.6 mm
Housing material	Aluminum extruded profile

Ambient data

Enclosure rating	IP65 (IEC 60529) IP67 (IEC 60529)
Ambient operating temperature	0 °C ... +55 °C
Storage temperature	-30 °C ... +70 °C
Air humidity	15 % ... 95 %, Non-condensing
Vibration resistance	5 g, 10 Hz ... 55 Hz (IEC 60068-2-6)
Shock resistance	10 g, 16 ms (IEC 60068-2-27)

Other information

Wave length	Near-infrared (NIR), invisible
-------------	--------------------------------

Ordering information

Scanning range	Number of beams	Beam separation	Sender		Receiver	
			Type	Part no.	Type	Part no.
17 m	2	500 mm	M2C-SX0250LA10	1093813	M2C-EX02500A10	1093899
	3	400 mm	M2C-SX0340LA10	1093900	M2C-EX03400A10	1093903
	4	300 mm	M2C-SX0430LA10	1093904	M2C-EX04300A10	1093909
90 m	2	500 mm	M2C-SX0250HA10	1093898	M2C-EX02500A10	1093899
	3	400 mm	M2C-SX0340HA10	1093902	M2C-EX03400A10	1093903
	4	300 mm	M2C-SX0430HA10	1093906	M2C-EX04300A10	1093909

Dimensional drawing (Dimensions in mm (inch))

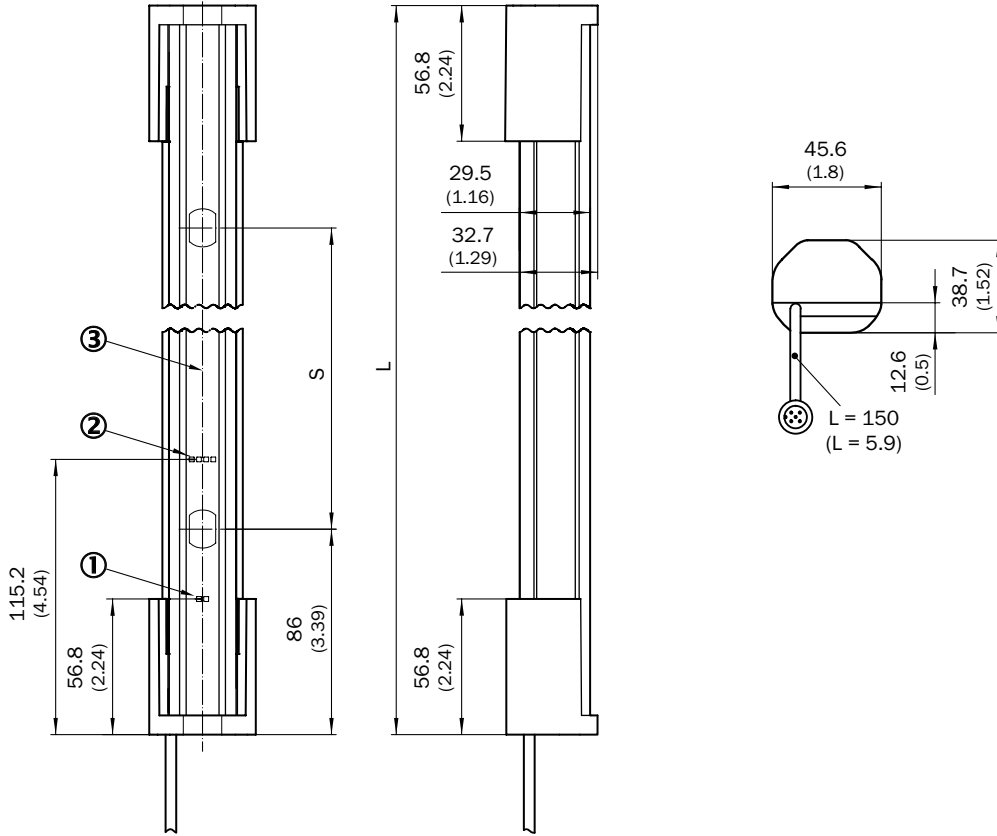



- ① Operating indicator
- ② Alignment indicator
- ③ Optical axis

Number of beams	Beam separation S	Length L
2	500 (19.69)	672 (26.46)
3	400 (15.75)	972 (38.27)
4	300 (11.81)	1,072 (42.2)

Recommended accessories

Mounting systems

Terminal and alignment brackets

Figure	Description	Packing unit	Type	Part no.
	FlexFix mounting kit for 1 device, e.g. sender or receiver (FlexFix bracket, alignment tool and assembly materials for installation in PU3H device columns), plastic	2 pieces	BEF-1SHABBKU2	2073543
	FlexFix bracket for 1 device (e.g. sender or receiver), can be aligned $\pm 15^\circ$, including M5 screw, plastic	2 pieces	BEF-1SHABPKU2	2098709
	FlexFix bracket for 2 devices (e.g. sender and receiver), can be aligned $\pm 15^\circ$, including M5 screw, plastic	4 pieces	BEF-1SHABPKU4	2066614
	QuickFix bracket for 1 device (e.g. sender or receiver), plastic	2 pieces	BEF-3SHABPKU2	2066048
	QuickFix bracket for 2 devices (e.g. sender and receiver), plastic	4 pieces	BEF-3SHABPKU4	2098710

Other mounting accessories

Mounting tools



Figure	Description	Packing unit	Type	Part no.
	Alignment tool for aligning sensors in areas with limited accessibility, e.g. device columns	1 piece	Alignment tool	4084133

Connection systems

Plug connectors and cables

Connecting cables

- **Model:** PUR, halogen-free, unshielded

Figure	Connection type		Conductor cross-section	Length of cable	Type	Part no.
	Female connector, M12, 5-pin, straight	Flying leads	0.34 mm ²	2 m	YF2A15-020UB5XLEAX	2095617
				5 m	YF2A15-050UB5XLEAX	2095618
				10 m	YF2A15-100UB5XLEAX	2095619
				15 m	YF2A15-150UB5XLEAX	2095620
				20 m	YF2A15-200UB5XLEAX	2095614
				30 m	YF2A15-300UB5XLEAX	2095621
	Female connector, M12, 5-pin, angled	Flying leads	0.34 mm ²	2 m	YG2A15-020UB5XLEAX	2095772
				5 m	YG2A15-050UB5XLEAX	2095773
				10 m	YG2A15-100UB5XLEAX	2095774



Adapters and distributors

T-junctions

Figure	Description	Type	Part no.
	T-piece for simultaneous connection to sender and receiver, splits the cable from the control cabinet to the sender and receiver, 5-pin	DSC-1205T000025KM0	6030664

Reflectors and optics

Alignment aids

Figure	Description	Type	Part no.
	Laser alignment aid for various sensors, laser class 2 (IEC 60825). Do not look into the beam!	AR60	1015741
	Adapter AR60 for deTec4, deTec2 and MLG-2	AR60 adapter, deTec, deTem, MLG-2	4070854

Optics cloths

Figure	Description	Type	Part no.
	Cloth for cleaning optical surfaces	Lens cloth	4003353

Further accessories

Test and monitoring tools

Figure	Description	Type	Part no.
	30 mm diameter	Test rod 30 mm	2022602

Cleaning agent

Figure	Description	Type	Part no.
	Plastic cleaner and care product, anti-static, 0.5 liter	Plastic cleaner	5600006

READY FOR EXPLOSIVE ATMOSPHERES



Product description

The deTec4 Ex safety light curtain in its explosion-proof enclosure is specially designed and approved for use under the strict safety requirements found in hazardous locations in accordance with

ATEX, IECEx, and NEC. Pre-wired and fully mounted within the housing, the complete system is also UL certified and represents a truly outstanding product that is unique within the market.

At a glance

- Pre-assembled and pre-wired safety light curtain in an explosion-proof enclosure
- Certified for use in explosive atmospheres in accordance with ATEX, IECEx and NEC thanks to explosion-proof enclosure
- Available in protective field heights of 450 mm, 600 mm, 900 mm, 1,200 mm, and 1,500 mm

Your benefits

- The way the device is assembled – complete with cable and pre-installed within the explosion-proof enclosure – not only saves on installation time but also on certification costs
- Maximum safety and automation in explosive atmospheres thanks to compliance with stringent regulations and strict safety requirements
- Straightforward installation and alignment
- LEDs offer a quick overview of the device status to reduce downtime and maximize productivity



Additional information

Detailed technical data67
 Ordering information 69
 Recommended accessories 69

→ www.sick.com/deTec

For more information, simply enter the link or scan the QR code and get direct access to technical data, CAD design models, operating instructions, software, application examples, and much more.



Detailed technical data

Features

Application	Explosive areas
Ex-approvals	ATEX for gas: II 2 G Ex db IIB T6 ATEX for dust: II 2 D Ex tb IIIC T56°C Db IP6X NFPA 70/NEC 500 Class I, Div. 1, Groups C and D NFPA 70/NEC 500 Class II, Div. 1, Groups E, F and G NFPA 70/NEC 500 Class III, Div. 1
Protective field height	450 mm ... 1,500 mm (depending on type)
Scanning range	25.2 m
Synchronization	Optical synchronisation
Integrated laser alignment aid	✓

Safety-related parameters

Type	Type 4 (IEC 61496-1)
Safety integrity level	SIL3 (IEC 61508) SILCL3 (IEC 62061)
Category	Category 4 (ISO 13849-1)
Performance level	PL e (ISO 13849-1)
PFH_D (mean probability of a dangerous failure per hour)	15.3 x 10 ⁻⁹
T_M (mission time)	20 years (ISO 13849-1)
Safe state in the event of a fault	At least one OSSD is in the OFF state.

Functions

Protective operation	✓
Automatic calibration of the protective field width	✓
Beam coding	✓
Restart interlock	✓
External device monitoring (EDM)	✓

Interfaces

Connection type	Connecting cable (30 m) with flying leads, 8-wire
Configuration method	DIP switch on system plug
Display elements	LEDs
Display of the synchronization status of the upper and lower beams	✓
Application diagnostic output (ADO)	✓
Fieldbus, industrial network	
Integration via Flexi Soft safety controller	CANopen, DeviceNet™, EtherCAT®, EtherNet/IP™, Modbus TCP, PROFIBUS DP, PROFINET ¹⁾

¹⁾ For additional information on Flexi Soft → www.sick.com/Flexi_Soft

Electrical data

Protection class	III (IEC 61140)
Supply voltage V_s	24 V DC (19.2 V ... 28.8 V)
Ripple	$\leq 10 \%$
Output signal switching devices (OSSDs)	
Type of output	2 PNP semiconductors, short-circuit protected, cross-circuit monitored ¹⁾
ON state, switching voltage HIGH	24 V DC ($V_s - 2.25 \text{ V DC} \dots V_s$)
OFF state, switching voltage LOW	$\leq 2 \text{ V DC}$
Current-carrying capacity per OSSD	$\leq 500 \text{ mA}$
Application diagnostic output (ADO)	
Type of output	PNP semiconductor, short-circuit protected ¹⁾
Output voltage HIGH (active)	$\geq V_s - 3 \text{ V}$
Output voltage LOW (deactivated)	High resistance
Output current HIGH (active)	$\leq 100 \text{ mA}$

¹⁾ Applies to the voltage range between -30 V and +30 V.

Mechanical data

Housing cross-section	161.8 mm x 142.1 mm
Housing material	Aluminum casting / AISi7Mg0,6

Ambient data

Enclosure rating	IP65 (IEC 60529) IP66 (IEC 60529)
Ambient operating temperature	-20 °C ... +55 °C
Storage temperature	-30 °C ... +70 °C
Air humidity	15 % ... 95 %, Non-condensing
Vibration resistance	5 g, 10 Hz ... 55 Hz (IEC 60068-2-6)
Shock resistance	10 g, 16 ms (IEC 60068-2-27)

Other information

Wave length	850 nm
Type of light	Near-infrared (NIR), invisible
Integrated laser alignment aid	✓
Laser class	1
Wave length	650 nm
Type of light	Visible red light

Ordering information

Resolution	Scanning range	Protective field height	Sender		Receiver	
			Type	Part no.	Type	Part no.
30 mm	25.2 m	450 mm	EXS-06D6113A020	1097705	EXE-06D6113A020	1097704
		600 mm	EXS-06D6213A020	1097702	EXE-06D6213A020	1097701
		900 mm	EXS-09D6413A020	1097708	EXE-09D6413A020	1097707
		1,200 mm	EXS-12D6613A020	1097711	EXE-12D6613A020	1097710
		1,500 mm	EXS-12D6813A020	1097714	EXE-12D6813A020	1097713

Recommended accessories

Mounting systems

Terminal and alignment brackets

Figure	Description	Packing unit	Type	Part no.
	Alignment bracket for explosion-proof enclosure	2 pieces	BEF-1SHABRST2	2072525

Connection systems



Plug connectors and cables

Other connectors and cables

Figure	Description	Type	Part no.
	Cable gland for the European market	Cable gland	5329002

Reflectors and optics

Alignment aids

Figure	Description	Type	Part no.
	Laser alignment aid for various sensors, laser class 2 (IEC 60825). Do not look into the beam!	AR60	1015741
	Adapter AR60 for explosion-proof enclosure	AR60 adapter, Ex	2074849

Further accessories

Test and monitoring tools

Figure	Description	Type	Part no.
	30 mm diameter	Test rod 30 mm	2022602

SAFETY IN EXPLOSIVE ENVIRONMENTS



Product description

The explosion-proof enclosure for safety light curtains is designed and approved for use in hazardous locations according to ATEX for gas: II 2 G Ex db IIB T6; for dust: II 2 D Ex tb IIIC T56°C Db IP6X; NFPA 70/NEC 500 Class I, Div. 1, groups C and D; Class II, Div. 1, groups E, F, and G; Class III, Div. 1. The enclosure is compatible with a variety of SICK safety

light curtains to fit multiple applications including paint booths, granaries, chemical processing and many others. The explosion-proof enclosure and safety light curtains have been tested together and are UL listed to give you the peace of mind that your safety solution meets the necessary safety and regulatory standards.

At a glance

- ATEX for gas: II 2 G Ex db IIB T6
- ATEX for dust: II 2 D Ex tb IIIC T56°C Db IP6X
- NFPA 70/NEC 500 Class I, Div. 1, Groups C and D
- NFPA 70/NEC 500 Class II, Div. 1, Groups E, F and G
- NFPA 70/NEC 500 Class III, Div. 1
- Available in protective field heights of 600 mm, 900 mm, 1,200 mm and 1,500 mm
- Resolution of 30 mm
- Scanning range of 10 m

Your benefits

- Compatibility with multiple SICK safety light curtains offers maximum flexibility in your application
- Durable design with flexible adjustment and handling of the whole device provides easy installation and alignment
- Pre-mounted and pre-wired safety light curtains in the enclosure reduces installation time and cost
- The IP66 enclosure rating protects the safety light curtain from water and dust to reduce downtime
- Highly visible LED status indicators provide quick troubleshooting
- One source for worldwide delivery and support of complete safety solutions



Additional information

Detailed technical data71
 Ordering information72
 Recommended accessories72

→ www.sick.com/deTec

For more information, simply enter the link or scan the QR code and get direct access to technical data, CAD design models, operating instructions, software, application examples, and much more.



Detailed technical data

Features

Application	Explosive areas
Ex-approvals	ATEX for gas: II 2 G Ex db IIB T6 ATEX for dust: II 2 D Ex tb IIIC T56°C Db IP6X NFPA 70/NEC 500 Class I, Div. 1, Groups C and D NFPA 70/NEC 500 Class II, Div. 1, Groups E, F and G NFPA 70/NEC 500 Class III, Div. 1
Resolution	30 mm
Protective field height	600 mm ... 1,500 mm (depending on type)
Scanning range	10 m
Synchronization	Optical synchronisation

Safety-related parameters

Type	Type 4 (IEC 61496-1)
Safety integrity level	SIL3 (IEC 61508) SILCL3 (IEC 62061)
Category	Category 4 (ISO 13849-1)
Performance level	PL e (ISO 13849-1)
PFH_D (mean probability of a dangerous failure per hour)	3.7×10^{-9}
T_M (mission time)	20 years (ISO 13849-1)
Safe state in the event of a fault	At least one OSSD is in the OFF state.

Functions

Protective operation	✓
Automatic calibration of the protective field width	✓

Interfaces

Connection type	Connecting cable (30 m) with flying leads, 5-wire
Display elements	LEDs
Fieldbus, industrial network	
Integration via Flexi Soft safety controller	CANopen, DeviceNet™, EtherCAT®, EtherNet/IP™, Modbus TCP, PROFIBUS DP, PROFINET ¹⁾

¹⁾ For additional information on Flexi Soft → www.sick.com/Flexi_Soft

Electrical data

Protection class	III (IEC 61140)
Supply voltage V_s	24 V DC (19.2 V ... 28.8 V)
Ripple	≤ 10 %
Output signal switching devices (OSSDs)	
Type of output	2 PNP semiconductors, short-circuit protected, cross-circuit monitored ¹⁾
ON state, switching voltage HIGH	24 V DC (V _s - 2.25 V DC ... V _s)
OFF state, switching voltage LOW	≤ 2 V DC
Current-carrying capacity per OSSD	≤ 300 mA

¹⁾ Applies to the voltage range between -30 V and +30 V.

Mechanical data

Housing cross-section	161.8 mm x 142.1 mm
Housing material	Aluminum casting / AISi7Mg0,6

Ambient data

Enclosure rating	IP65 (IEC 60529) IP66 (IEC 60529)
Ambient operating temperature	-20 °C ... +55 °C
Storage temperature	-30 °C ... +70 °C
Air humidity	15 % ... 95 %, Non-condensing
Vibration resistance	5 g, 10 Hz ... 55 Hz (IEC 60068-2-6)
Shock resistance	10 g, 16 ms (IEC 60068-2-27)

Other information

Wave length	850 nm
Type of light	Near-infrared (NIR), invisible

Ordering information

Resolution	Scanning range	Protective field height	Sender		Receiver	
			Type	Part no.	Type	Part no.
30 mm	10 m	600 mm	EXS-06D6203B020	1068407	EXE-06D6203B020	1068406
		900 mm	EXS-09D6403B020	1068410	EXE-09D6403B020	1068409
		1,200 mm	EXS-12D6603B020	1068413	EXE-12D6603B020	1068412
		1,500 mm	EXS-12D6803B020	1068416	EXE-12D6803B020	1068415

Recommended accessories

Mounting systems

Terminal and alignment brackets

Figure	Description	Packing unit	Type	Part no.
	Alignment bracket for explosion-proof enclosure	2 pieces	BEF-1SHABRST2	2072525

Connection systems



Plug connectors and cables

Other connectors and cables

Figure	Description	Type	Part no.
	Cable gland for the European market	Cable gland	5329001

Reflectors and optics

Alignment aids

Figure	Description	Type	Part no.
	Laser alignment aid for various sensors, laser class 2 (IEC 60825). Do not look into the beam!	AR60	1015741
	Adapter AR60 for explosion-proof enclosure	AR60 adapter, Ex	2074849

Further accessories

Test and monitoring tools

Figure	Description	Type	Part no.
	30 mm diameter	Test rod 30 mm	2022602

SAFETY IN EXPLOSIVE ENVIRONMENTS

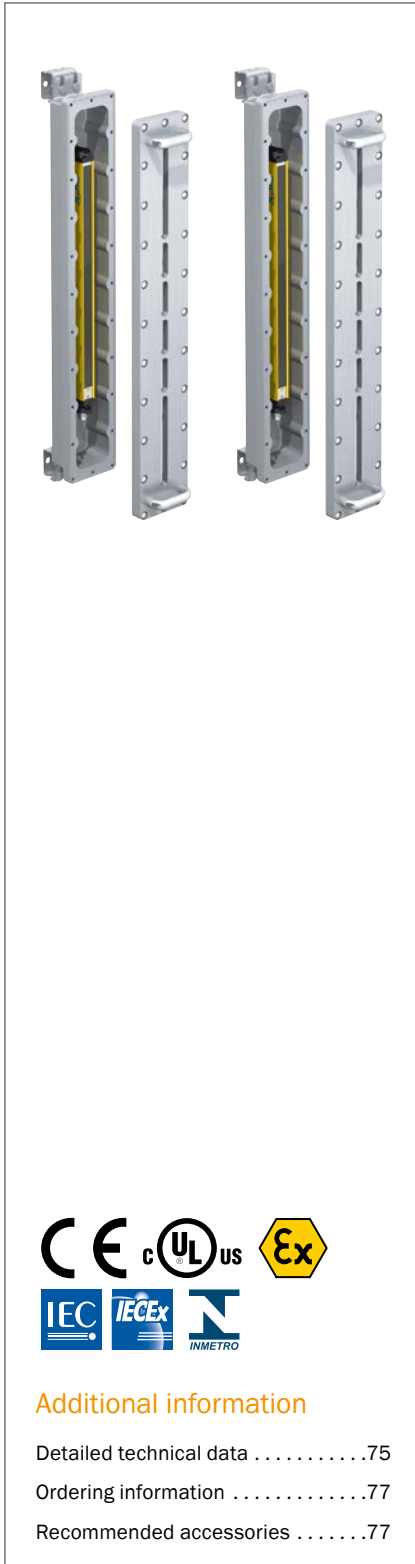

Product description

The explosion-proof enclosure for safety light curtains is designed and approved for use in hazardous locations according to ATEX for gas: II 2 G Ex db IIB T6; for dust: II 2 D Ex tb IIIC T56°C Db IP6X; NFPA 70/NEC 500 Class I, Div. 1, Groups C and D; Class II, Div. 1, Groups E, F and G; Class III, Div. 1. The enclosure is compatible with a variety of SICK safety

light curtains to fit multiple applications including paint booths, granaries, chemical processing and many others. The explosion-proof enclosure and safety light curtains have been tested together and are UL listed to give you the peace of mind that your safety solution meets the necessary safety and regulatory standards.

At a glance

- ATEX for gas: II 2 G Ex db IIB T6
- ATEX for dust: II 2 D Ex tb IIIC T56°C Db IP6X
- NFPA 70/NEC 500 Class I, Div. 1, Groups C and D
- NFPA 70/NEC 500 Class II, Div. 1, Groups E, F and G
- NFPA 70/NEC 500 Class III, Div. 1
- Available in protective field heights of 600 mm, 900 mm and 1,200 mm
- Resolution of 30 mm
- Scanning range of 16 m

Your benefits

- Compatibility with numerous SICK safety light curtains makes high flexibility in the application solution possible
- Durable housing
- Simple installation and alignment with the special mounting system
- Quick commissioning of pre-mounting systems, comprises light curtain and housing
- Low downtimes thanks to resistance to water and dust as a result of enclosure rating IP 66
- Well visible LED status indicator for quick fault diagnosis
- Global availability and support for the entire safety solution



Additional information

- Detailed technical data75
- Ordering information77
- Recommended accessories77

→ www.sick.com/C4000_Advanced_Ex

For more information, simply enter the link or scan the QR code and get direct access to technical data, CAD design models, operating instructions, software, application examples, and much more.



Detailed technical data

Features

Application	Explosive areas
Ex-approvals	ATEX for gas: II 2 G Ex db IIB T6 ATEX for dust: II 2 D Ex tb IIIC T56°C Db IP6X NFPA 70/NEC 500 Class I, Div. 1, Groups C and D NFPA 70/NEC 500 Class II, Div. 1, Groups E, F and G NFPA 70/NEC 500 Class III, Div. 1
Resolution	30 mm
Protective field height	600 mm / 900 mm / 1,200 mm (depending on type)
Scanning range	16 m
Synchronization	Optical synchronisation

Safety-related parameters

Type	Type 4 (IEC 61496-1)
Safety integrity level	SIL3 (IEC 61508) SILCL3 (EN 62061)
Category	Category 4 (EN ISO 13849)
Performance level	PL e (EN ISO 13849)
PFH_D (mean probability of a dangerous failure per hour)	15 x 10 ⁻⁹ (EN ISO 13849)
T_M (mission time)	20 years (EN ISO 13849)
Safe state in the event of a fault	At least one OSSD is in the OFF state.

Functions

	Functions	Delivery status
Restart interlock	✓	External
External device monitoring (EDM)	✓	Deactivated
Beam coding	✓	Uncoded
Configurable scanning range	✓	0 m ... 5 m
Safe SICK device communication via EFI	✓	

Functions in combination with UE402

Bypass	✓
Operating mode switching	✓
PSDI mode	✓

Interfaces

System connection	
Connection type	Connecting cable (30 m) with flying leads, 12-wire
Configuration connection	
Connection type	Female connector M8, 4-pin
Configuration method	PC with CDS (Configuration and Diagnostic Software)
Display elements	7-segment display
Fieldbus, industrial network	
Integration via EFI gateways	PROFINET PROFIsafe ¹⁾
Integration via Flexi Soft safety controller	CANopen, DeviceNet™, EtherCAT®, EtherNet/IP™, Modbus TCP, PROFIBUS DP, PROFINET ²⁾

¹⁾ For a suitable EFI-gateway see modules and gateways in the accessory section of connection systems.

²⁾ For additional information on Flexi Soft → www.sick.com/Flexi_Soft

Electrical data

Protection class	III (IEC 61140)
Supply voltage V_s	24 V DC (19.2 V ... 28.8 V) ¹⁾
Residual ripple	≤ 10 % ²⁾
Output signal switching devices (OSSDs)	
Type of output	2 PNP semiconductors, short-circuit protected, cross-circuit monitored ³⁾
ON state, switching voltage HIGH	24 V DC ($V_s - 2.25$ V DC ... V_s)
OFF state, switching voltage LOW	≤ 3.5 V DC
Current-carrying capacity per OSSD	≤ 500 mA
Application diagnostic output (ADO)	
Type of output	PNP semiconductor, short-circuit protected ³⁾
Output voltage HIGH (active)	24 V DC ($V_s - 4.2$ V DC ... V_s)
Output voltage LOW (deactivated)	High resistance
Output current HIGH (active)	≤ 100 mA

¹⁾ The external voltage supply must be capable of buffering brief mains voltage failures of 20 ms as specified in EN 60204-1. Suitable power supplies are available as accessories from SICK.

²⁾ Within the limits of V_s .

³⁾ Applies to the voltage range between -30 V and +30 V.

Mechanical data

Housing cross-section	161.8 mm x 142.1 mm
Housing material	Aluminum casting / AISi7Mg0,6

Ambient data

Enclosure rating	IP65 (EN 60529) IP66 (EN 60529)
Ambient operating temperature	0 °C ... +55 °C
Storage temperature	-25 °C ... +70 °C
Air humidity	15 % ... 95 %, Non-condensing
Vibration resistance	5 g, 10 Hz ... 55 Hz (EN 60068-2-6)
Shock resistance	10 g, 16 ms (EN 60068-2-27)

Other information

Wave length	950 nm
Type of light	Near-infrared (NIR), invisible

Ordering information

Resolution	Scanning range	Protective field height	Sender		Receiver	
			Type	Part no.	Type	Part no.
30 mm	16 m	600 mm	EXS-06C6203B020	1068398	EXE-06C6203B020	1068397
		900 mm	EXS-09C6403B020	1068401	EXE-09C6403B020	1068400
		1,200 mm	EXS-12C6603B020	1068404	EXE-12C6603B020	1068403

Recommended accessories

Mounting systems

Terminal and alignment brackets

Figure	Description	Packing unit	Type	Part no.
	Alignment bracket for explosion-proof enclosure	2 pieces	BEF-1SHABRST2	2072525

Connection systems

Plug connectors and cables

Other connectors and cables

Figure	Description	Type	Part no.
	Cable gland for the European market	Cable gland	5329002



Modules and gateways

EFl gateways

Figure	Description	Type	Part no.
	PROFINET PROFIsafe	UE4740-22H0000	1046978

Reflectors and optics

Alignment aids

Figure	Description	Type	Part no.
	Laser alignment aid for various sensors, laser class 2 (IEC 60825). Do not look into the beam!	AR60	1015741
	Adapter AR60 for explosion-proof enclosure	AR60 adapter, Ex	2074849

Optics cloths

Figure	Description	Type	Part no.
	Cloth for cleaning optical surfaces	Lens cloth	4003353

Further accessories

Test and monitoring tools

Figure	Description	Type	Part no.
	30 mm diameter	Test rod 30 mm	2022602

Cleaning agent

Figure	Description	Type	Part no.
	Plastic cleaner and care product, anti-static, 0.5 liter	Plastic cleaner	5600006

Safety relays

Switching amplifiers

Figure	Description	Type	Part no.
 Illustration may differ	UE402 switching amplifier	UE402	1023577

READY FOR EXPLOSIVE ATMOSPHERES

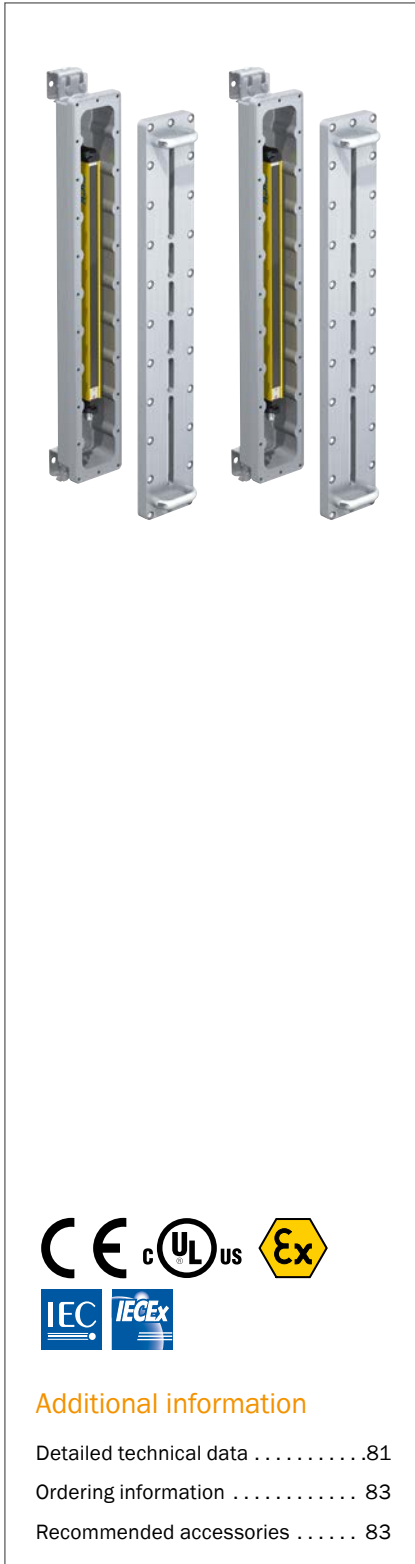

Additional information

Detailed technical data81
 Ordering information 83
 Recommended accessories 83

Product description

The C4000 Fusion Ex safety light curtain in its explosion-proof enclosure is specially designed and approved for use under the strict safety requirements found in hazardous locations in accordance

with ATEX, IECEx, and NEC. Pre-wired and fully mounted within the housing, the complete system is also UL certified and represents a truly outstanding product that is unique within the market.

At a glance

- Certified for use in explosive atmospheres in accordance with ATEX, IECEx and NEC thanks to explosion-proof enclosure
- Access protection that can differentiate between personnel and materials – without muting
- Hazardous point protection with optional regular blanking
- Available in protective field heights of 600 mm, 900 mm, and 1,200 mm

Your benefits

- The way the device is assembled – complete with cable and pre-installed within the explosion-proof enclosure – not only saves on installation time but also on certification costs
- Maximum safety and automation in explosive atmospheres thanks to compliance with stringent regulations and strict safety requirements
- Straightforward installation and alignment
- Maximum safety for access protection with automated material transport – the system reliably differentiates between personnel and materials without the need for an additional muting sensor
- Maximum availability thanks to regular blanking: Skids are detected and interference objects such as cables are blanked

→ www.sick.com/C4000_Fusion_Ex

For more information, simply enter the link or scan the QR code and get direct access to technical data, CAD design models, operating instructions, software, application examples, and much more.



Detailed technical data

Features

Application	Explosive areas
Ex-approvals	ATEX for gas: II 2 G Ex db IIB T6 ATEX for dust: II 2 D Ex tb IIIC T56°C Db IP6X NFPA 70/NEC 500 Class I, Div. 1, Groups C and D NFPA 70/NEC 500 Class II, Div. 1, Groups E, F and G NFPA 70/NEC 500 Class III, Div. 1
Resolution	30 mm
Protective field height	600 mm / 900 mm / 1,200 mm (depending on type)
Scanning range	17.6 m
Synchronization	Optical synchronisation

Safety-related parameters

Type	Type 4 (IEC 61496-1)
Safety integrity level	SIL3 (IEC 61508) SILCL3 (EN 62061)
Category	Category 4 (EN ISO 13849)
Performance level	PL e (EN ISO 13849)
PFH _D (mean probability of a dangerous failure per hour)	15 x 10 ⁻⁹ (EN ISO 13849)
T _M (mission time)	20 years (EN ISO 13849)
Safe state in the event of a fault	At least one OSSD is in the OFF state.

Functions

	Functions	Delivery status
Protective operation	✓	
Restart interlock	✓	External
External device monitoring (EDM)	✓	Deactivated
Beam coding	✓	Uncoded
Configurable scanning range	✓	
Reduced resolution	✓	Deactivated
Fixed blanking	✓	Deactivated
Floating blanking	✓	Deactivated
Dynamic blanking for object pattern recognition	✓	
Self-teach dynamic blanking for goods detection	✓	
Self-teach dynamic blanking for pallet detection	✓	
Multiple sampling	✓	2x evaluation
Direction monitoring	✓	
Virtual photoelectric switches	✓	
Sensor gap monitoring	✓	
Sequence monitoring	✓	
Object entry monitoring	✓	
Detection of geometrically even objects	✓	
Safe SICK device communication via EFI	✓	

Functions in combination with UE402

Bypass	✓
Operating mode switching	✓

Interfaces

System connection	
Connection type	Connecting cable (30 m) with flying leads, 12-wire
Configuration connection	
Connection type	Female connector M8, 4-pin
Configuration method	PC with CDS (Configuration and Diagnostic Software)
Display elements	7-segment display
Fieldbus, industrial network	
Integration via EFI gateways	PROFINET PROFIsafe ¹⁾
Integration via Flexi Soft safety controller	CANopen, DeviceNet™, EtherCAT®, EtherNet/IP™, Modbus TCP, PROFIBUS DP, PROFINET ²⁾

¹⁾ For a suitable EFI-gateway see modules and gateways in the accessory section of connection systems.

²⁾ For additional information on Flexi Soft → www.sick.com/Flexi_Soft

Electrical data

Protection class	III (IEC 61140)
Supply voltage V_s	24 V DC (19.2 V ... 28.8 V) ¹⁾
Residual ripple	≤ 10 % ²⁾
Output signal switching devices (OSSDs)	
Type of output	2 PNP semiconductors, short-circuit protected, cross-circuit monitored ³⁾
ON state, switching voltage HIGH	24 V DC ($V_s - 2.25$ V DC ... V_s)
OFF state, switching voltage LOW	≤ 3.5 V DC
Current-carrying capacity per OSSD	≤ 500 mA
Application diagnostic output (ADO)	
Type of output	PNP semiconductor, short-circuit protected ³⁾
Output voltage HIGH (active)	24 V DC ($V_s - 4.2$ V DC ... V_s)
Output voltage LOW (deactivated)	High resistance
Output current HIGH (active)	≤ 100 mA

¹⁾ The external voltage supply must be capable of buffering brief mains voltage failures of 20 ms as specified in EN 60204-1. Suitable power supplies are available as accessories from SICK.

²⁾ Within the limits of V_s .

³⁾ Applies to the voltage range between -30 V and +30 V.

Mechanical data

Housing cross-section	161.8 mm x 142.1 mm
Housing material	Aluminum casting / AISi7Mg0,6

Ambient data

Enclosure rating	IP65 (EN 60529) IP66 (EN 60529)
Ambient operating temperature	0 °C ... +55 °C
Storage temperature	-25 °C ... +70 °C
Air humidity	15 % ... 95 %, Non-condensing
Vibration resistance	5 g, 10 Hz ... 55 Hz (EN 60068-2-6)
Shock resistance	10 g, 16 ms (EN 60068-2-27)

Other information

Wave length	950 nm
Type of light	Near-infrared (NIR), invisible

Ordering information

Resolution	Scanning range	Protective field height	Sender		Receiver	
			Type	Part no.	Type	Part no.
30 mm	17.6 m	600 mm	EXS-06C6202A020	1097726	EXE-06C6202A020	1097725
		900 mm	EXS-09C6402A020	1097729	EXE-09C6402A020	1097728
		1,200 mm	EXS-12C6602A020	1097732	EXE-12C6602A020	1097731

Recommended accessories

Mounting systems

Terminal and alignment brackets

Figure	Description	Packing unit	Type	Part no.
	Alignment bracket for explosion-proof enclosure	2 pieces	BEF-1SHABRST2	2072525

Connection systems

Plug connectors and cables

Other connectors and cables

Figure	Description	Type	Part no.
	Cable gland for the European market	Cable gland	5329002



Modules and gateways

EFI gateways

Figure	Description	Type	Part no.
	PROFINET PROFI-safe	UE4740-22H0000	1046978

Reflectors and optics

Alignment aids

Figure	Description	Type	Part no.
	Laser alignment aid for various sensors, laser class 2 (IEC 60825). Do not look into the beam!	AR60	1015741
	Adapter AR60 for explosion-proof enclosure	AR60 adapter, Ex	2074849

Optics cloths

Figure	Description	Type	Part no.
	Cloth for cleaning optical surfaces	Lens cloth	4003353

Further accessories

Test and monitoring tools

Figure	Description	Type	Part no.
	30 mm diameter	Test rod 30 mm	2022602

Cleaning agent

Figure	Description	Type	Part no.
	Plastic cleaner and care product, anti-static, 0.5 liter	Plastic cleaner	5600006

Safety relays

Switching amplifiers

Figure	Description	Type	Part no.
 Illustration may differ	UE402 switching amplifier	UE402	1023577

READY FOR EXPLOSIVE ATMOSPHERES



Product description

The deTem4 Core Ex safety multibeam sensor in its explosion-proof enclosure is specially designed and approved for use under the strict safety requirements found in hazardous locations in accordance with ATEX, IECEx, and NEC.

Pre-wired and fully mounted within the housing, the complete system is also UL certified and represents a truly outstanding product that is unique within the market.

At a glance

- Pre-assembled and pre-wired safety multibeam sensor in an explosion-proof enclosure
- Certified for use in explosive atmospheres in accordance with ATEX, IECEx and NEC thanks to explosion-proof enclosure
- Typical scanning range of up to 14.2 m
- Versions with 2, 3, and 4 light beams

Your benefits

- The way the device is assembled – complete with cable and pre-installed within the explosion-proof enclosure – not only saves on installation time but also on certification costs
- Maximum safety and automation in explosive atmospheres thanks to compliance with stringent regulations and strict safety requirements
- Long scanning range facilitates efficient access protection with minimal component requirements
- Straightforward installation and alignment



Additional information

Detailed technical data87
 Ordering information 88
 Recommended accessories 88

→ www.sick.com/deTem4_Core_Ex

For more information, simply enter the link or scan the QR code and get direct access to technical data, CAD design models, operating instructions, software, application examples, and much more.



Detailed technical data

Features

Application	Explosive areas
Ex-approvals	ATEX for gas: II 2 G Ex db IIB T6 ATEX for dust: II 2 D Ex tb IIIC T56°C Db IP6X NFPA 70/NEC 500 Class I, Div. 1, Groups C and D NFPA 70/NEC 500 Class II, Div. 1, Groups E, F and G NFPA 70/NEC 500 Class III, Div. 1
Scanning range	14.2 m
Number of beams	2 / 3 / 4 (depending on type)
Beam separation	500 mm / 400 mm / 300 mm (depending on type)
Response time	20 ms
Synchronization	Optical synchronisation

Safety-related parameters

Type	Type 4 (IEC 61496-1)
Safety integrity level	SIL3 (IEC 61508) SILCL3 (IEC 62061)
Category	Category 4 (ISO 13849-1)
Performance level	PL e (ISO 13849-1)
PFH_D (mean probability of a dangerous failure per hour)	3 x 10 ⁻⁹
T_M (mission time)	20 years (ISO 13849-1)
Safe state in the event of a fault	At least one OSSD is in the OFF state.

Functions

Protective operation	✓
-----------------------------	---

Interfaces

System connection	
Connection type	Connecting cable (30 m) with flying leads, 5-wire
Display elements	LEDs
Fieldbus, industrial network	
Integration via Flexi Soft safety controller	CANopen, DeviceNet™, EtherCAT®, EtherNet/IP™, Modbus TCP, PROFIBUS DP, PROFINET ¹⁾

¹⁾ For additional information on Flexi Soft → www.sick.com/Flexi_Soft

Electrical data

Protection class	III (IEC 61140)
Supply voltage V_s	24 V DC (19.2 V DC ... 28.8 V DC) ¹⁾
Residual ripple	≤ 10 % ²⁾
Output signal switching devices (OSSDs)	
Type of output	2 PNP semiconductors, short-circuit protected, cross-circuit monitored ³⁾
ON state, switching voltage HIGH	24 V DC (V _s - 2.25 V DC ... V _s)
OFF state, switching voltage LOW	≤ 2 V DC
Current-carrying capacity per OSSD	≤ 300 mA

¹⁾ The external voltage supply must be capable of buffering brief mains voltage failures of 20 ms as specified in EN 60204-1. Suitable power supplies are available as accessories from SICK.

²⁾ Within the limits of V_s.

³⁾ Applies to the voltage range between -30 V and +30 V.

Mechanical data

Housing cross-section	161.8 mm x 142.1 mm
Housing material	Aluminum casting / AlSi7Mg0,6

Ambient data

Enclosure rating	IP65 (IEC 60529) IP66 (IEC 60529)
Ambient operating temperature	-20 °C ... +55 °C
Storage temperature	-30 °C ... +70 °C
Air humidity	15 % ... 95 %, Non-condensing
Vibration resistance	5 g, 10 Hz ... 55 Hz (IEC 60068-2-6)
Shock resistance	10 g, 16 ms (IEC 60068-2-27)

Other information

Wave length	Near-infrared (NIR), invisible
--------------------	--------------------------------

Ordering information

Scanning range	Number of beams	Beam separation	Sender		Receiver	
			Type	Part no.	Type	Part no.
14.2 m	2	500 mm	EXS-06D0250A020	1097717	EXE-06D0250A020	1097716
	3	400 mm	EXS-09D0340A020	1097720	EXE-09D0340A020	1097719
	4	300 mm	EXS-12D0430A020	1097723	EXE-12D0430A020	1097722

Recommended accessories

Mounting systems

Terminal and alignment brackets

Figure	Description	Packing unit	Type	Part no.
	Alignment bracket for explosion-proof enclosure	2 pieces	BEF-1SHABRST2	2072525

Connection systems



Plug connectors and cables

Other connectors and cables

Figure	Description	Type	Part no.
	Cable gland for the European market	Cable gland	5329002

Reflectors and optics

Alignment aids

Figure	Description	Type	Part no.
	Laser alignment aid for various sensors, laser class 2 (IEC 60825). Do not look into the beam!	AR60	1015741
	Adapter AR60 for explosion-proof enclosure	AR60 adapter, Ex	2074849

Optics cloths

Figure	Description	Type	Part no.
	Cloth for cleaning optical surfaces	Lens cloth	4003353

Further accessories

Test and monitoring tools

Figure	Description	Type	Part no.
	30 mm diameter	Test rod 30 mm	2022602

Cleaning agent

Figure	Description	Type	Part no.
	Plastic cleaner and care product, anti-static, 0.5 liter	Plastic cleaner	5600006

WORKING WITH SICK IN A DIGITAL WORLD

Making your digital business environment comfortable

Find a suitable solution in next to no time

- Online product catalog
- Application Solver
- Online configurators and selectors

My SICK is your personal self-service portal

- Open around the clock
- Clear product information
- Company-specific price conditions
- Convenience during the ordering process
- Document overview
- Availability and delivery times

Register now:

→ www.sick.com/myBenefits

Even more value

- Digital Customer Trainings → www.sick.com/c/g300887
- Digital Service Catalog → cloud.sick.com
- SICK AppPool → apppool.cloud.sick.com



SERVICES FOR MACHINES AND PLANTS: SICK LifeTime Services

Our comprehensive and versatile LifeTime Services are the perfect addition to the comprehensive range of products from SICK. The services range from product-independent consulting to traditional product services.



Consulting and design
Safe and professional



Product and system support
Reliable, fast, and on-site



Verification and optimization
Safe and regularly inspected



Upgrade and retrofits
Easy, safe, and economical



Training and education
Practical, focused, and professional

SICK AT A GLANCE

SICK is a leading manufacturer of intelligent sensors and sensor solutions for industrial applications. With more than 10,400 employees and over 50 subsidiaries and equity investments as well as numerous agencies worldwide, SICK is always close to its customers. A unique range of products and services creates the perfect basis for controlling processes securely and efficiently, protecting individuals from accidents, and preventing damage to the environment.

SICK has extensive experience in various industries and understands their processes and requirements. With intelligent sensors, SICK delivers exactly what the customers need. In application centers in Europe, Asia, and North America, system solutions are tested and optimized in accordance with customer specifications. All this makes SICK a reliable supplier and development partner.

Comprehensive services round out the offering: SICK LifeTime Services provide support throughout the machine life cycle and ensure safety and productivity.

That is “Sensor Intelligence.”

Worldwide presence:

Australia, Austria, Belgium, Brazil, Canada, Chile, China, Czech Republic, Denmark, Finland, France, Germany, Great Britain, Hungary, Hong Kong, India, Israel, Italy, Japan, Malaysia, Mexico, Netherlands, New Zealand, Norway, Poland, Romania, Russia, Singapore, Slovakia, Slovenia, South Africa, South Korea, Spain, Sweden, Switzerland, Taiwan, Thailand, Turkey, United Arab Emirates, USA, Vietnam.

Detailed addresses and further locations → www.sick.com