



# Safe series connection

GUIDELINES FOR SMART DECISION MAKERS

Industrial safety systems

**SICK**  
Sensor Intelligence.

# SAFE MACHINE STOP WHEN LINKING PROTECTIVE DEVICES

Large machine systems have one thing in common across all industries: Different types of machines need different protective devices. As complexity increases, so do the requirements on integration. Nevertheless, all safety sensors used have the same goal: To ensure the machine stops safely when there is a fault or danger.

The big challenge: To safely bring all safety sensors together. The solution from SICK: Safe series connection.

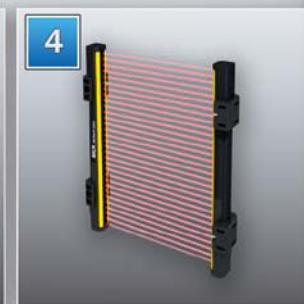

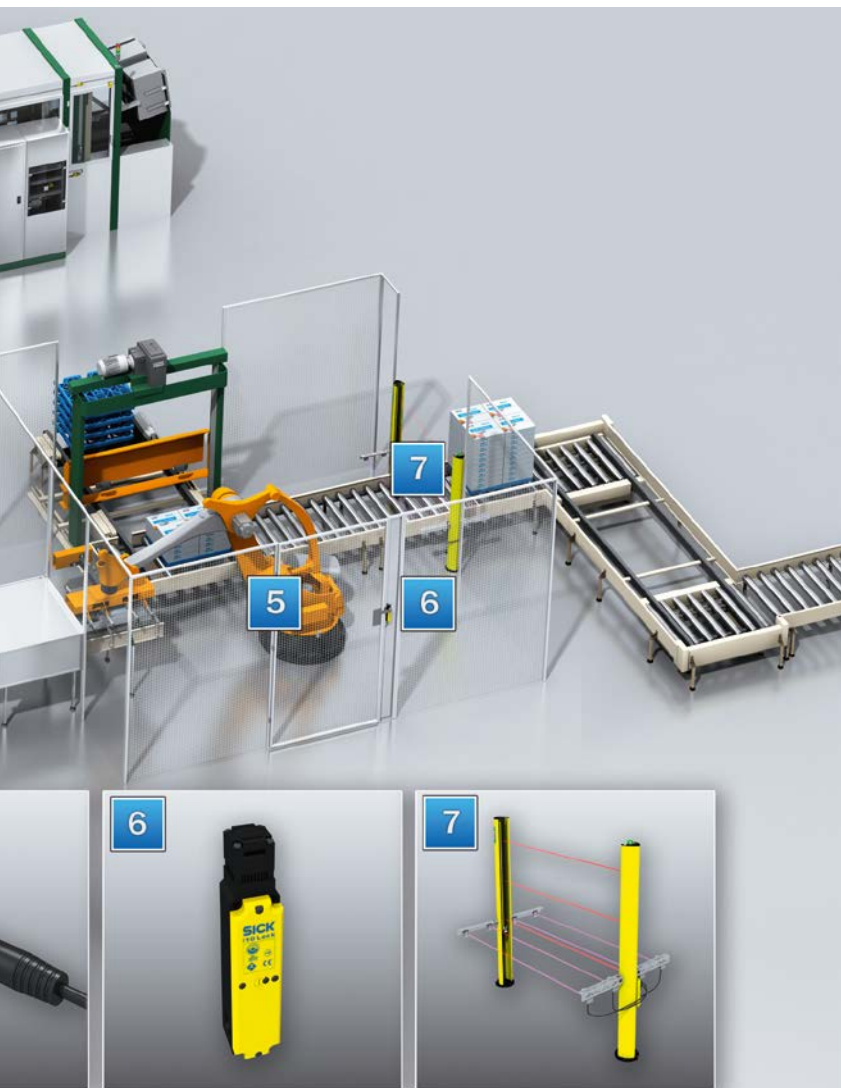

## Safe series connection from SICK

- Saves up to 75 % of installation time
- Reduces the number of required safe inputs
- Minimizes wiring effort

Solutions from SICK . . . . .	5
Individual wiring . . . . .	6
Series connection of sensors with volt-free contacts . . . . .	7
Series connection of sensors with monitored semiconductor outputs . . . .	8
Safe series connection with Flexi Loop . . . . .	9
Selection guide and ordering information. . . . .	12
Annex Glossary. . . . .	24

# THE RIGHT SOLUTION TO FIT ANY REQUIREMENTS

Different industry sectors, different tasks, different requirements – modern industry is becoming increasingly diverse. It's good when you have a reliable partner in this environment – and that's SICK. This is because SICK offers every customer an appropriate solution for wiring sensors.

- For the conventional machine manufacturer who produces compact machines and individually wires the required sensors
- For the manufacturer of machine systems who looks to safely wire several simple protective devices in series
- For the producer of flexible machine modules, who wants to cascade a variety of safety sensors, and in doing so pays close attention to safety and diagnostic information

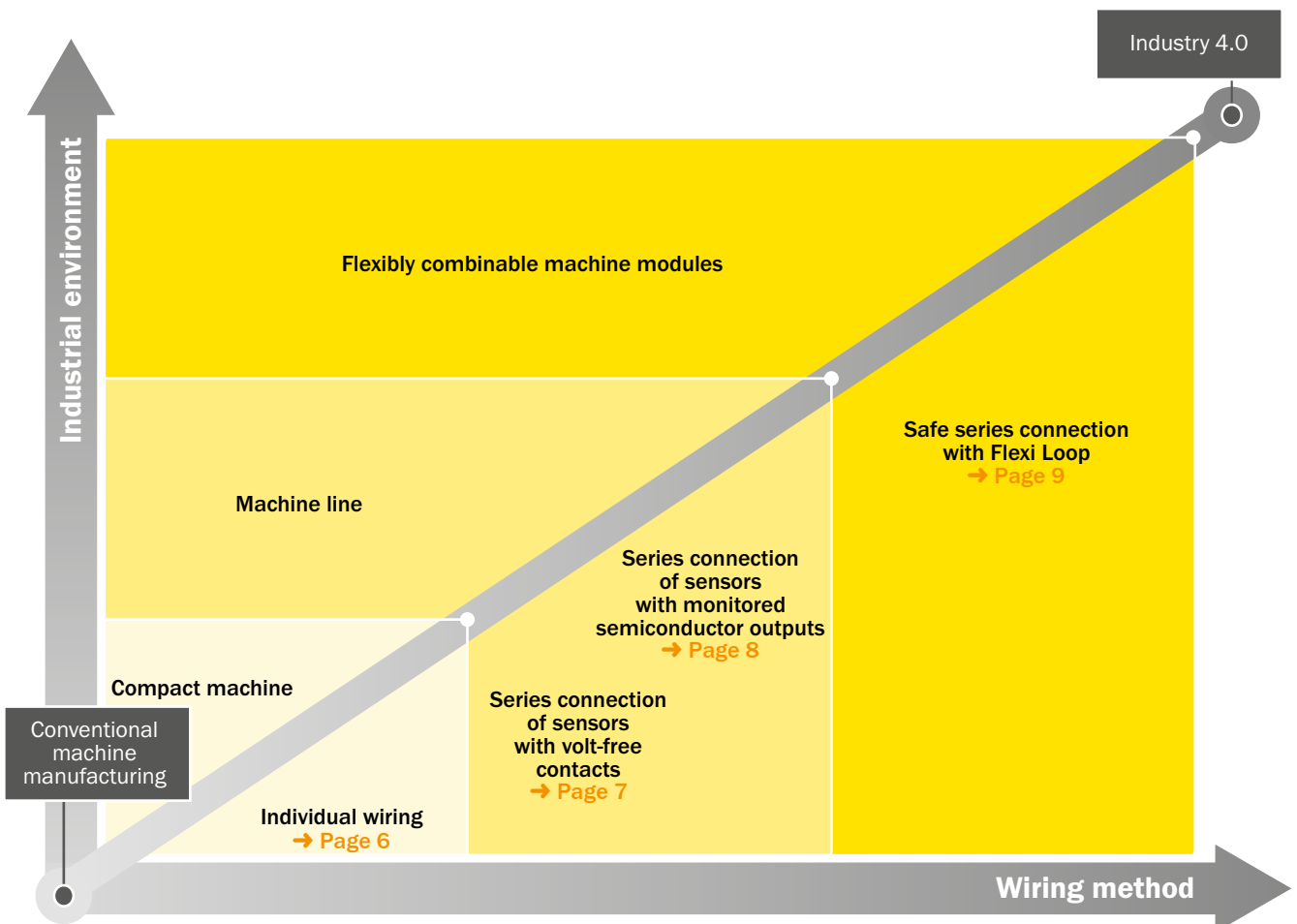

If you're finding the decision difficult, ask yourself this: what are the relevant requirements when selecting the wiring method?

### Safety

Detecting faults and ensuring a safe status

- ★☆☆☆☆ not all faults are detected
- ★★★★★★ all faults are detected

### Diagnostics

Determining which protective device has been activated and which fault has occurred

- ★☆☆☆☆ no diagnostic option
- ★★★★★★ enhanced diagnostics using light emitting diodes on the protective device and application diagnostic output

### Wiring

Wiring complexity, material costs and time required

- ★☆☆☆☆ wiring with high complexity
- ★★★★★★ wiring with low complexity

### Cost effectiveness

Material cost of the components, cost of installation, number of safety inputs required for safety evaluation

- ★☆☆☆☆ high overall costs
- ★★★★★★ low overall costs

### Flexibility

Option of combining different sensors, possibility of expanding the solution

- ★☆☆☆☆ only a certain product type can be used in the series connection; complicated expansion
- ★★★★★★ different sensors can be combined in one series connection; simple expansion of the solution using new sensors

## SOLUTIONS FROM SICK

	Individual wiring	Series connection of sensors with volt-free contacts	Series connection of sensors with monitored semiconductor outputs	Safe series connection with Flexi Loop
Safety	★★★★★★	★☆☆☆☆	★★★★★★	★★★★★★
Diagnosis	★★★★★★	★☆☆☆☆	★★★★★	★★★★★★
Wiring	★☆☆☆☆	★★★★★	★★★★★★	★★★★★★
Cost effectiveness	★☆☆☆☆	★★★★★	★★★★★★	★★★★★★
Flexibility	★★★★★	★☆☆☆☆	★☆☆☆☆	★★★★★★
Classification	The safe and established solution	The cost-effective solution for lower safety requirements	The safe solution for sensors with semiconductor outputs	Flexible, innovative and safe

And what do the wiring methods look like in detail?

# INDIVIDUAL WIRING

The safe and established solution

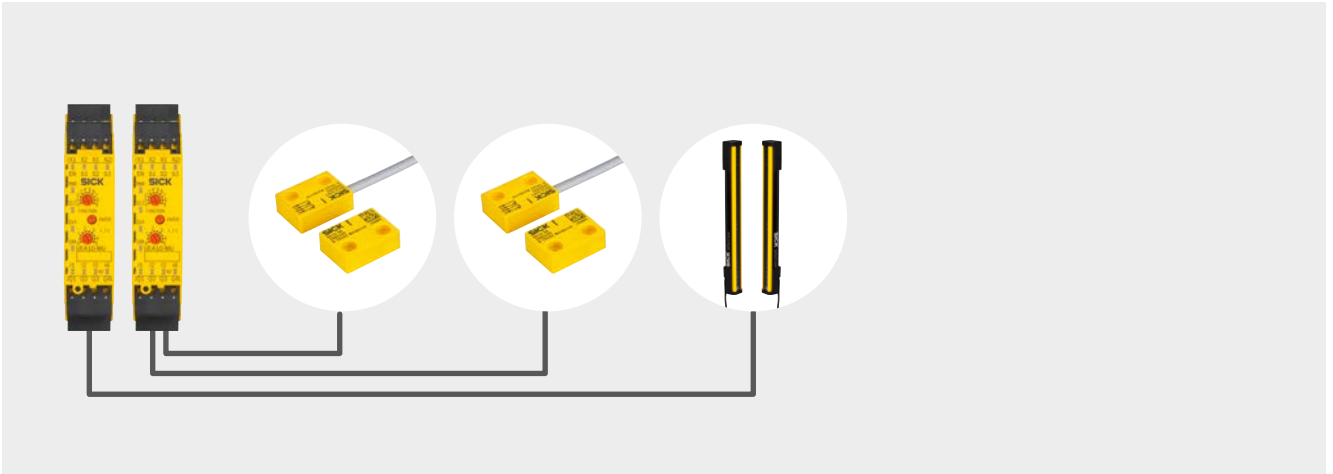

When connecting a low number of sensors or connecting sensors of different types, individual wiring is an established method.

- + The highest level of safety and good diagnostic options, since, due to the individual evaluation if a fault occurs, it can be easily determined which sensor is faulty
- + All types of sensors can be connected
- Very high wiring complexity, since for each sensor a separate cable to the evaluation unit has to be laid
- High amount of space required in the control cabinet due to additional evaluation units or input expansion modules
- Limited flexibility, since the complex wiring makes it very difficult to expand

Safety	★★★★★
Diagnosis	★★★★★
Wiring	★☆☆☆☆
Cost effectiveness	★☆☆☆☆
Flexibility	★★★★☆

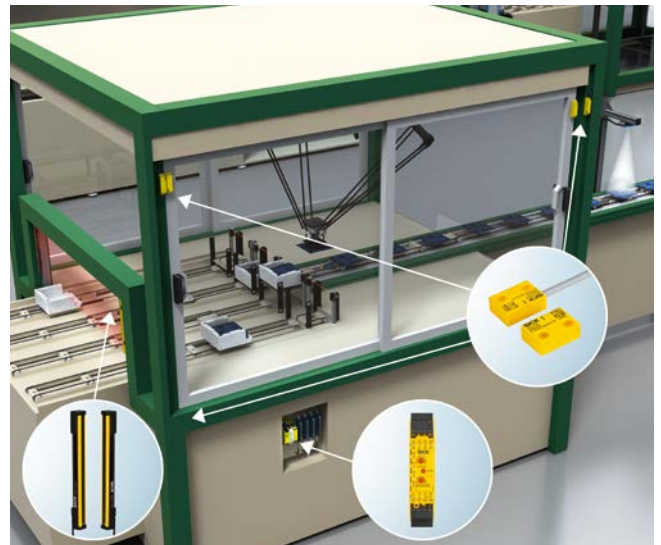

# SERIES CONNECTION OF SENSORS WITH VOLT-FREE CONTACTS

The cost-effective solution where there are low safety requirements

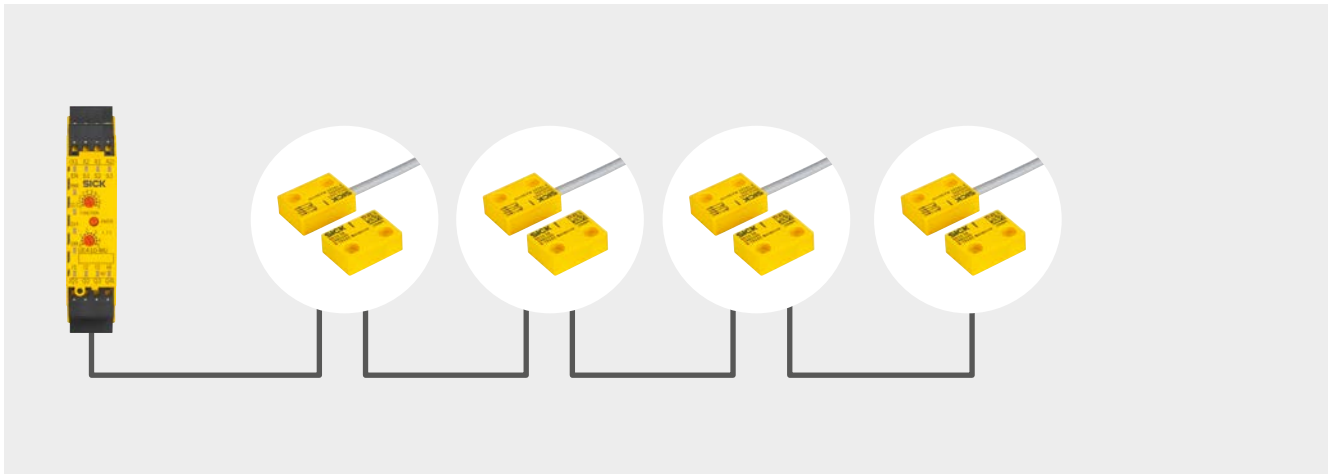

With a low number of sensors and low requirements, for example infrequent operation, there is the option of a hard-wired series connection of the sensors with volt-free contacts (e.g. electro-mechanical safety switches, magnetic safety switches).

- + Lower wiring complexity compared with individual wiring
- + High cost-effectiveness
- Limited safety and reduced performance level because of possible fault maskin  
→ [Annex, pagee 24](#)
- No diagnostic option
- Low flexibility, since only certain sensors with equivalent (only N/O or only N/C) volt-free contacts can be wired using this method

Safety	★☆☆☆☆
Diagnosis	★☆☆☆☆
Wiring	★★★★☆
Cost effectiveness	★★★★★
Flexibility	★☆☆☆☆



# SERIES CONNECTION OF SENSORS WITH MONITORED SEMICONDUCTOR OUTPUTS

The safe solution for sensors with semiconductor outputs

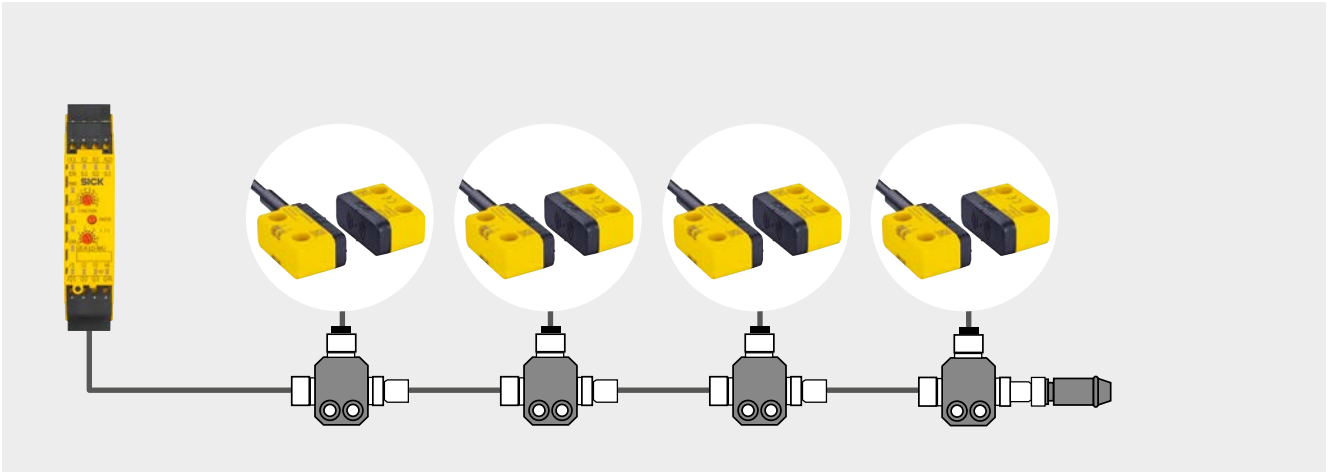

Series connection is also possible via sensors with monitored semiconductor outputs such as the deTec4 Prime safety light curtain or the STR1 transponder safety switch. The 8-pin cascadable variants of the STR1 feature two safety capable inputs and 2 safety outputs can be easily connected in series with T-connectors.

- + Simple and direct connection to a safe control
- + Highest level of safety and immediate fault detection via test pulses of the monitored semiconductor outputs; The STR1 transponder safety switches thereby fulfill performance level PL e even if up to 30 devices are connected in series
- + Very easy wiring of the individual sensors with M12 plug connector and T-connector
- Limited diagnostic option via LED displays on sensor
- Low level of flexibility since only the safety sensors with monitored semiconductor outputs (such as STR1 and deTec4 Prime) can be connected in series

Safety	★★★★★
Diagnosis	★★★☆☆
Wiring	★★★★★
Cost effectiveness	★★★★★
Flexibility	★☆☆☆☆

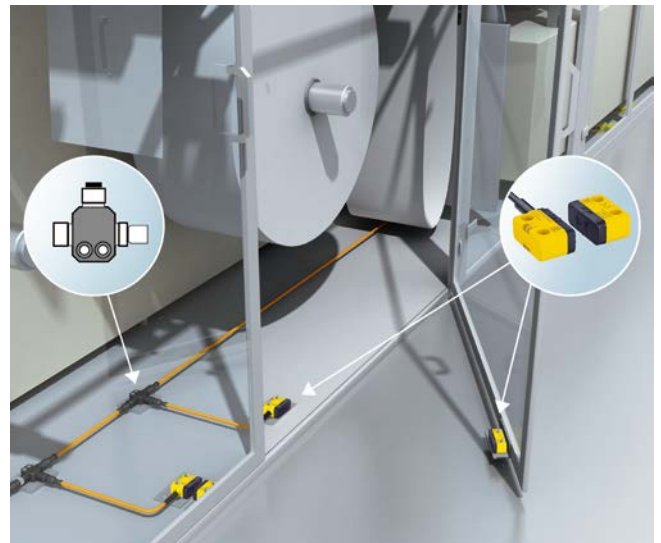



# SAFE SERIES CONNECTION WITH FLEXI LOOP

Flexible, innovative and safe

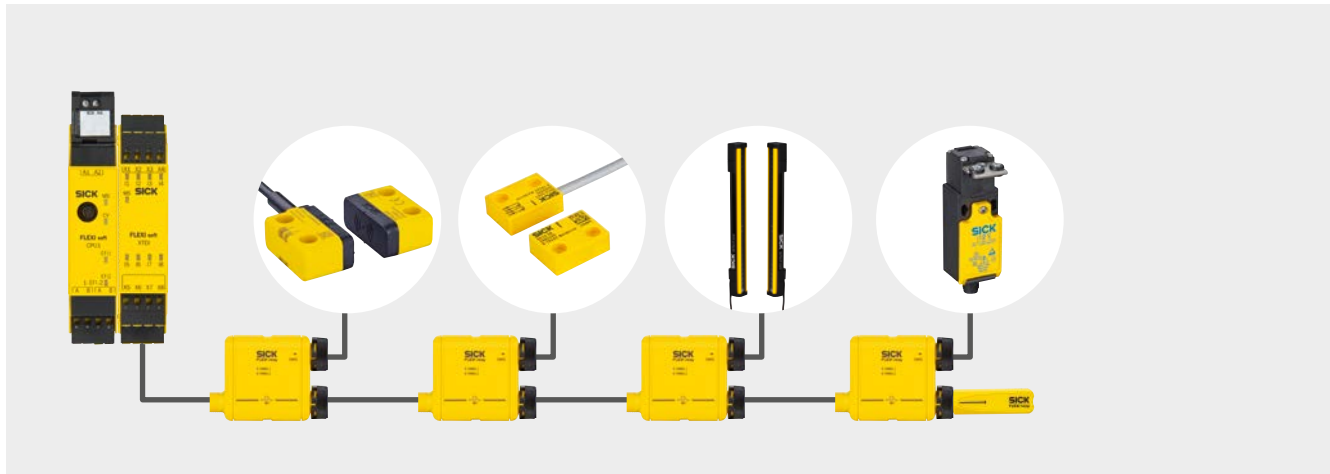

Cost-effective, supports diagnostics, safe: Flexi Loop is the best solution for series connection of safety switches and other safety sensors within a machine.

- +** Compliance with the highest level of safety when up to 32 safety sensors which are of a different construction and use different technology are connected in series
- +** Expanded diagnostic options and direct transmission of current information at a superordinate automation level
- +** Cost saving by minimized and very simple wiring using the M12 wiring technique
- +** User friendly due to quick and easy configuration
- +** The highest level of flexibility and compatibility, even with sensors from other manufacturers
- +** Easy retrofitting of existing machines

Safety	★★★★★★
Diagnosis	★★★★★★
Wiring	★★★★★★
Cost effectiveness	★★★★★★
Flexibility	★★★★★★



# YET MORE CHOICE WITH FLEXI LOOP

There's nothing more flexible: SICK also provides suitable solutions to different requirements for safety controllers.

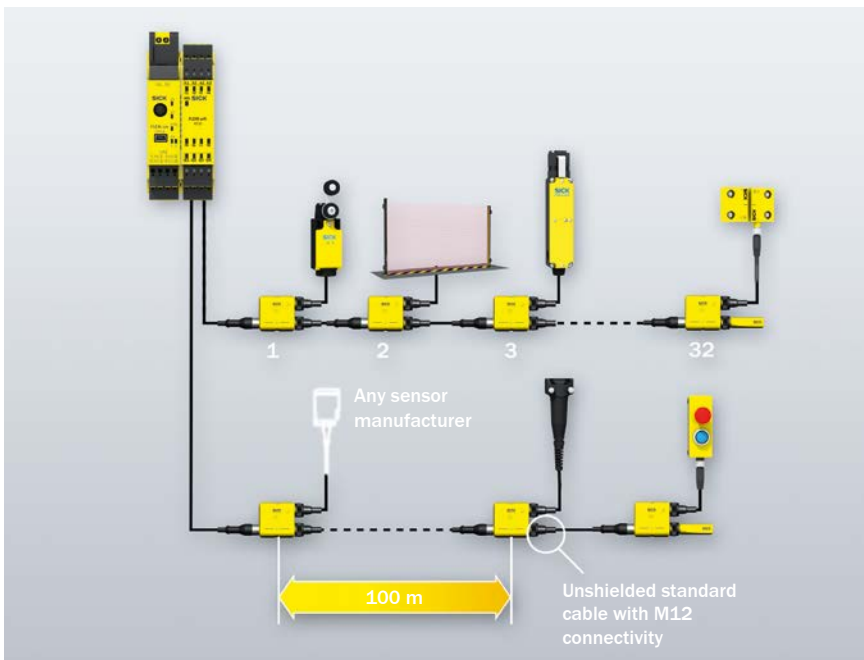

There is, on the one hand, the Flexi Soft safety controller. It is modular, intuitive and can be easily and freely configured using software. Since 2008, Flexi Soft has been one of the best-selling safety controllers in the safety technology industry. Using a range of main modules, expansion modules, motion control modules and gateways, it is possible to create a customized solution for your safety application. And together with Flexi Loop for the safe series connection of up to 32 switches and sensors, it is particularly suitable for protecting large machine systems.

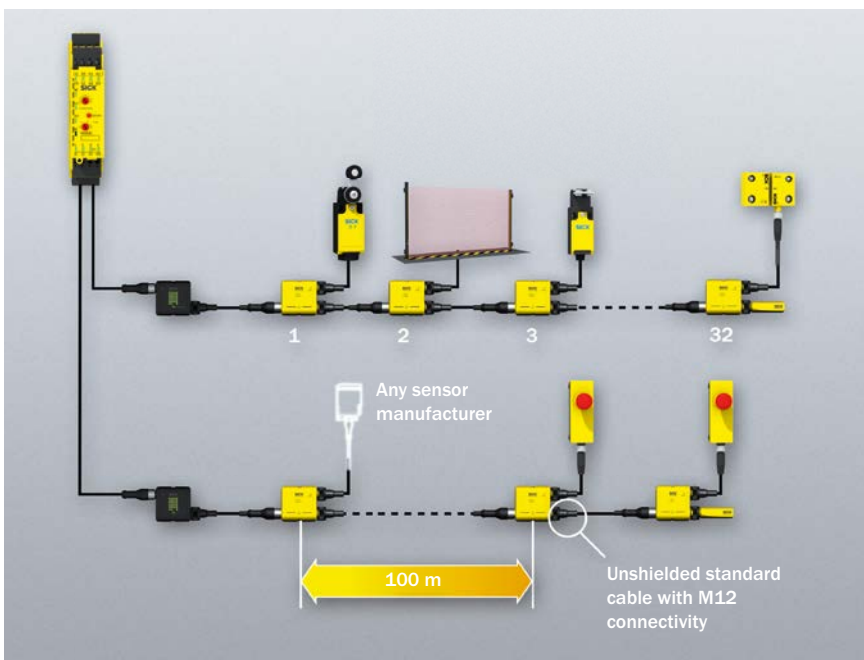

The Flexi Classic safety controller is the ideal solution for simple control tasks. It efficiently ensures that machines are immediately stopped in the case of danger or a fault. The main advantage of using the Flexi Classic is that the logic is generated without software. With very little effort, the user can set and adjust the configuration directly on the module using rotary switches. Connection to Flexi Loop is carried out via the Flexi Loop master nodes. The clever interpreting unit transmits relevant safety information from the cascade, and sends the corresponding safety signals back to the safety controller.

## Clear and detailed diagnostic options with Flexi Soft

There is a significant flaw in other methods of series connection: limited diagnostic options lead to unnecessary down time and therefore higher costs for maintenance and repair.

Flexi Loop puts an end to this:

- Providing detailed information: which safety sensor has operated and why (normal operation vs. sensor fault)?
- Monitoring the entire safety cascade
- All information can be implemented in the software logic and is processed there
- Information can be transferred to gateways and is therefore available in all standard fieldbuses for integration into standard automation
- Reducing idle times through information visualization via man-machine interfaces







# SELECTION GUIDE AND ORDERING INFORMATION

Make more from the sum of the individual parts: 1 + 1 = 3



Safety solutions from SICK allow you to work more efficiently. And the principle is simple: Combine a Flexi-Loop-ready safety sensor from SICK with a Flexi Loop node - up to 32 times. By connecting to a safety controller (e.g. Flexi Soft), you create a series connection tailored to your requirements and the complexity of your machine system. In addition to the individual components, in this combination, you receive the safe series connection as an additional benefit. We say: 1 + 1 = 3

■ = Safe series connection.



Safety sensor		Flexi Loop			
		For volt-free contacts		For monitored semiconductor outlets	
		FLN-EMSS0000105 5-pin	FLN-EMSS1100108 8-pin	FLN-OSSD1000105 5-pin	FLN-OSSD1100108 8-pin
<b>Electro-mechanical safety switches</b>					
	i12S	■			
	i16S	■			
	i110S	■			
	i10 Lock		■		
	i110 Lock		■		
<b>Non-contact safety switches</b>					
	RE13 / RE23	■			
	RE27		■		
	TR4 Direct			■	■
	STR1			■	■
	IN3000 Direct			■	
	IN4000 Direct			■	
<b>Safety command devices</b>					
	i110RP	■			
	i150RP	■			
	ES11-SA1xx	■			
	ES11-Sx2xx / ES11-Sx4xx		■		
<b>Safety light curtains</b>					
	deTec 4 Prime			■	
	deTec4 Core			■	
	deTec2 Core			■	
<b>Multiple light beam safety devices <sup>1)</sup></b>					
	M4000 Advanced Curtain			■	
	M4000 Advanced			■	

<sup>1)</sup> The DSL-6182G01M034KM1 connecting cable (female connector M26 / male connector M12) should be used to connect multiple light beam safety devices to the Flexi Loop.



## Flexi Loop

Figure	Description	Safety device connection	Type	Part number
	For dual-channel equivalent electro-mechanical safety switches	M12 5-pin	FLN-EMSS0000105	1061711
		M12 8-pin	FLN-EMSS1100108	1061712
	For safety sensors with dual-channel semiconductor (OSSD) outputs	M12 5-pin	FLN-OSSD1000105	1061709
		M12 8-pin	FLN-OSSD1100108	1061710
	Module to terminate cascade	-	FLT-TERM00001	1061716

## Flexi Loop accessories





Figure	Description	Type	Part number
	For energy supply	FLA-PWRI00001	1061715
	For diagnostics during operation and quick commissioning	FLA-DIAG00001	1061714
	Y-adapter (EMSS) For distributing the 8-pin connection of a Flexi Loop node into a 5-pin for connecting the safety devices, as well as a 5-pin connection for the non-safe input and output	FLA-YCON00001	2074733
	Y-adapter (OSSD) Like Y-adapter (EMSS)	FLA-YCON00002	2074734

## Flexi Loop accessories for connecting to the Flexi Classic



Figure	Description	Type	Part number
	Flexi Loop master nodes for connecting a Flexi Loop strand to the Flexi Classic and for system observation during operation and commissioning	FLA-MSTR00001	1061713
	Like FLA-MSTR00001, with IO-Link	FLA-MSTR00002	1067650

## Electro-mechanical safety switches (Flexi Loop-ready)

Safety switch with separate actuator: i12S, i16S, i110S



Figure	Description	Connection	Type	Part number
	2 N/C, 6 N retaining force	M12 4-pin	i12-SA205	1064506
	2 N/C, 15 N retaining force		i12-SB215	1064507
	2 N/C, 30 N retaining force		i16-SA205	1064508
	2 N/C, 12 N retaining force		i110-SA225	1064509

Safety locking devices: i10 Lock, i110 Lock



Figure	Description	Connection	Type	Part number
	Mechanical locking, 1,300 N locking force, 2 N/C for locking device monitoring, 1 N/C for door monitoring	M12 8-pin	i10-M0454	6045055
	Electrical locking, 1,300 N locking force, 2 N/C for locking device monitoring, 1 N/C for door monitoring		i10-E0454	6045056
	Electrical locking, 1,300 N locking force, 1 N/C for locking device monitoring, 2 N/C, only for process protection		i10-E0354	6053788
	Mechanical locking, 2,500 N locking force, 2 N/C for locking device monitoring, 1 N/C for door monitoring		i110-M0454	6051602
	Electrical locking, 2,500 N locking force, 2 N/C for locking device monitoring, 1 N/C for door monitoring		i110-E0454	6051603
	Electrical locking, 2,500 N locking force, 1 N/C for locking device monitoring, 2 N/C, only for process protection		i110-E0354	6053945

Non-contact safety switch (Flexi Loop-ready)

Magnetic safety switches: RE1, RE2

Figure	Description	Connection	Type	Part number
	RE1, 2 N/O, assured switch-on distance 7 mm	M12 4-pin	RE13-SA64	1062540
	RE2, 2 N/O, assured switch-on distance 9 mm	M12 4-pin	RE23-SA64	1062542
	RE2, 2 N/O + 1 auxiliary contact with LED, assured switch-on distance 9 mm	M12 8-pin	RE27-SA68LS04	1065233



Transponder safety switches: STR1

Figure	Description	Connection	Type	Part number
	STR1 with standard actuator, universally coded	M12 5-pin	STR1-SASMOAC5	1069560
	STR1 with standard actuator, unique coded		STR1-SASUOAC5	1072709
	STR1 with standard actuator, permanently coded		STR1-SASFOAC5	1073211
	STR1 with flat actuator, universally coded		STR1-SAFMOAC5	1069565
	STR1 with flat actuator, unique coded		STR1-SAFUOAC5	1069575
	STR1 with flat actuator, permanently coded		STR1-SAFFOAC5	1073206
	STR1 with mini actuator, universally coded		STR1-SAMMOAC5	1069570
	STR1 with mini actuator, unique coded		STR1-SAMUOAC5	1073205
	STR1 with mini actuator, permanently coded		STR1-SAMFOAC5	1073216

Recommended accessories



Figure	Description	Type	Part number
	T-connector for series connection of STR1	TR4-AK004C	5325889

Inductive safety switches: IN3000 Direct, IN4000 Direct



Figure	Description	Connection	Type	Part number
	Cylindrical M30, non-flush, assured switch-on distance 15 mm, up to PL d	M12 4-pin	IN30-E0208K	6044655
	Cylindrical M18, non-flush, assured switch-on distance 8 mm, up to PL d		IN30-E0305K	6034576
	Cylindrical M18, flush, assured switch-on distance 5 mm, up to PL d		IN30-E0206K	6034581
	Cylindrical M12, non-flush, assured switch-on distance 4 mm, up to PL d		IN30-E0407K	6034582
	Cuboid, non-flush, assured switch-on distance 15 mm, up to PL e		IN40-E0101K	6027388
	Cuboid, non-flush, assured switch-on distance 20 mm, up to PL e		IN40-E0109K	6050281

Safety command devices (Flexi Loop-ready)

Rope pull switch: i110RP, i150RP

Figure	Description	Connection	Type	Part number
	2 N/C, wire lengths up to 30 m	M12 4-pin	i110-RP224	1064510
	2 N/C, wire lengths up to 30 m		i150-RP224	1064511

Emergency stop pushbuttons: ES11

Figure	Description	Connection	Type	Part number
	Emergency stop pushbutton not illuminated, 2 N/C	M12 4-pin	ES11-SA1A4	6051327
	Emergency stop pushbutton illuminated, 2 N/C	M12 8-pin	ES11-SA2B8	6051328
	Emergency stop pushbutton not illuminated and reset button illuminated, 2 N/C / 1 N/O	M12 8-pin	ES11-SC4D8	6051329

Safety light curtains (Flexi Loop-ready)

deTec4 Prime

deTec4 Prime scope of delivery:

- Safety light curtain consisting of a sender and a receiver
- 2 system plugs
- 4 QuickFix brackets
- Test rod with diameter corresponding to the resolution of the safety light curtain
- Sticker with notes on daily thorough check
- Safety note
- Mounting instructions



deTec4 Prime with 5-pin system connection without extension connection

- **Use:** As single system or as the last system in a cascade
- **Resolution:** 14 mm
- **System connection:** Male connector M12, 5-pin
- **Minimum scanning range:** 0.15 m ... 10 m
- **Typical scanning range:** 0.15 m ... 16 m

Protective field height	Sender		Receiver	
	Type	Part no.	Type	Part no.
300 mm	C4P-SA03010A001000	1215556	C4P-EA03010A001000	1215583
450 mm	C4P-SA04510A001000	1215651	C4P-EA04510A001000	1215652
600 mm	C4P-SA06010A001000	1215653	C4P-EA06010A001000	1215654
750 mm	C4P-SA07510A001000	1215655	C4P-EA07510A001000	1215656
900 mm	C4P-SA09010A001000	1215657	C4P-EA09010A001000	1215658
1,050 mm	C4P-SA10510A001000	1215659	C4P-EA10510A001000	1215660
1,200 mm	C4P-SA12010A001000	1215661	C4P-EA12010A001000	1215662
1,350 mm	C4P-SA13510A001000	1215663	C4P-EA13510A001000	1215664
1,500 mm	C4P-SA15010A001000	1215665	C4P-EA15010A001000	1215666
1,650 mm	C4P-SA16510A001000	1215667	C4P-EA16510A001000	1215668
1,800 mm	C4P-SA18010A001000	1215669	C4P-EA18010A001000	1215670
1,950 mm	C4P-SA19510A001000	1215671	C4P-EA19510A001000	1215672
2,100 mm	C4P-SA21010A001000	1215673	C4P-EA21010A001000	1215674

- **Use:** As single system or as the last system in a cascade
- **Resolution:** 30 mm
- **System connection:** Male connector M12, 5-pin
- **Minimum scanning range:** 0.15 m ... 21 m
- **Typical scanning range:** 0.15 m ... 24 m

Protective field height	Sender		Receiver	
	Type	Part no.	Type	Part no.
300 mm	C4P-SA03030A001000	1215753	C4P-EA03030A001000	1215754
450 mm	C4P-SA04530A001000	1215755	C4P-EA04530A001000	1215756
600 mm	C4P-SA06030A001000	1215757	C4P-EA06030A001000	1215758
750 mm	C4P-SA07530A001000	1215759	C4P-EA07530A001000	1215760
900 mm	C4P-SA09030A001000	1215761	C4P-EA09030A001000	1215762
1,050 mm	C4P-SA10530A001000	1215763	C4P-EA10530A001000	1215764
1,200 mm	C4P-SA12030A001000	1215765	C4P-EA12030A001000	1215766
1,350 mm	C4P-SA13530A001000	1215767	C4P-EA13530A001000	1215768
1,500 mm	C4P-SA15030A001000	1215769	C4P-EA15030A001000	1215770
1,650 mm	C4P-SA16530A001000	1215771	C4P-EA16530A001000	1215772
1,800 mm	C4P-SA18030A001000	1215773	C4P-EA18030A001000	1215774
1,950 mm	C4P-SA19530A001000	1215775	C4P-EA19530A001000	1215776
2,100 mm	C4P-SA21030A001000	1215777	C4P-EA21030A001000	1215778



## deTec4 Prime with 5-pin system connection and 5-pin extension connection

- **Use:** As single system or as the first, middle or last system in a cascade
- **Resolution:** 14 mm
- **System connection:** Male connector M12, 5-pin
- **Extension connection:** Female connector M12, 5-pin
- **Minimum scanning range:** 0.15 m ... 10 m
- **Typical scanning range:** 0.15 m ... 16 m

Protective field height	Sender		Receiver	
	Type	Part no.	Type	Part no.
300 mm	C4P-SA03010A001100	1215675	C4P-EA03010A001100	1215676
450 mm	C4P-SA04510A001100	1215677	C4P-EA04510A001100	1215678
600 mm	C4P-SA06010A001100	1215679	C4P-EA06010A001100	1215680
750 mm	C4P-SA07510A001100	1215681	C4P-EA07510A001100	1215682
900 mm	C4P-SA09010A001100	1215683	C4P-EA09010A001100	1215684
1,050 mm	C4P-SA10510A001100	1215685	C4P-EA10510A001100	1215686
1,200 mm	C4P-SA12010A001100	1215687	C4P-EA12010A001100	1215688
1,350 mm	C4P-SA13510A001100	1215689	C4P-EA13510A001100	1215690
1,500 mm	C4P-SA15010A001100	1215691	C4P-EA15010A001100	1215692
1,650 mm	C4P-SA16510A001100	1215693	C4P-EA16510A001100	1215694
1,800 mm	C4P-SA18010A001100	1215695	C4P-EA18010A001100	1215696
1,950 mm	C4P-SA19510A001100	1215697	C4P-EA19510A001100	1215698
2,100 mm	C4P-SA21010A001100	1215699	C4P-EA21010A001100	1215700

- **Use:** As single system or as the first, middle or last system in a cascade
- **Resolution:** 30 mm
- **System connection:** Male connector M12, 5-pin
- **Extension connection:** Female connector M12, 5-pin
- **Minimum scanning range:** 0.15 m ... 21 m
- **Typical scanning range:** 0.15 m ... 24 m

Protective field height	Sender		Receiver	
	Type	Part no.	Type	Part no.
300 mm	C4P-SA03030A001100	1215779	C4P-EA03030A001100	1215780
450 mm	C4P-SA04530A001100	1215781	C4P-EA04530A001100	1215782
600 mm	C4P-SA06030A001100	1215783	C4P-EA06030A001100	1215784
750 mm	C4P-SA07530A001100	1215785	C4P-EA07530A001100	1215786
900 mm	C4P-SA09030A001100	1215787	C4P-EA09030A001100	1215788
1,050 mm	C4P-SA10530A001100	1215789	C4P-EA10530A001100	1215790
1,200 mm	C4P-SA12030A001100	1215791	C4P-EA12030A001100	1215792
1,350 mm	C4P-SA13530A001100	1215793	C4P-EA13530A001100	1215794
1,500 mm	C4P-SA15030A001100	1215795	C4P-EA15030A001100	1215796
1,650 mm	C4P-SA16530A001100	1215797	C4P-EA16530A001100	1215798
1,800 mm	C4P-SA18030A001100	1215799	C4P-EA18030A001100	1215800
1,950 mm	C4P-SA19530A001100	1215801	C4P-EA19530A001100	1215802
2,100 mm	C4P-SA21030A001100	1215803	C4P-EA21030A001100	1215804

deTec4 Core

deTec4 Core scope of delivery:

- Safety light curtain consisting of a sender and a receiver
- 4 QuickFix brackets
- Test rod with diameter corresponding to the resolution of the safety light curtain
- Operating instructions on CD-ROM
- Sticker with notes on daily thorough check

<b>Use</b>	As single system
<b>Connections/ports</b>	
System connection	Male connector, M12, 5-pin
<b>Type according to IEC 61496</b>	Type 4

- **Resolution:** 14 mm
- **Scanning range:** 0 m ... 7 m

Protective field height	Sender		Receiver	
	Type	Part no.	Type	Part no.
300 mm	C4C-SA03010A10000	1211450	C4C-EA03010A10000	1211463
450 mm	C4C-SA04510A10000	1211469	C4C-EA04510A10000	1211470
600 mm	C4C-SA06010A10000	1211471	C4C-EA06010A10000	1211472
750 mm	C4C-SA07510A10000	1211473	C4C-EA07510A10000	1211474
900 mm	C4C-SA09010A10000	1211475	C4C-EA09010A10000	1211515
1,050 mm	C4C-SA10510A10000	1211476	C4C-EA10510A10000	1211477
1,200 mm	C4C-SA12010A10000	1211478	C4C-EA12010A10000	1211479
1,350 mm	C4C-SA13510A10000	1211480	C4C-EA13510A10000	1211481
1,500 mm	C4C-SA15010A10000	1211482	C4C-EA15010A10000	1211483
1,650 mm	C4C-SA16510A10000	1211484	C4C-EA16510A10000	1211485
1,800 mm	C4C-SA18010A10000	1211486	C4C-EA18010A10000	1211487
1,950 mm	C4C-SA19510A10000	1211488	C4C-EA19510A10000	1211489
2,100 mm	C4C-SA21010A10000	1211490	C4C-EA21010A10000	1211491

- **Resolution:** 30 mm
- **Scanning range:** 0 m ... 10 m

Protective field height	Sender		Receiver	
	Type	Part no.	Type	Part no.
300 mm	C4C-SA03030A10000	1211462	C4C-EA03030A10000	1211464
450 mm	C4C-SA04530A10000	1211492	C4C-EA04530A10000	1211493
600 mm	C4C-SA06030A10000	1211494	C4C-EA06030A10000	1211495
750 mm	C4C-SA07530A10000	1211496	C4C-EA07530A10000	1211497
900 mm	C4C-SA09030A10000	1211498	C4C-EA09030A10000	1211516
1,050 mm	C4C-SA10530A10000	1211499	C4C-EA10530A10000	1211500
1,200 mm	C4C-SA12030A10000	1211501	C4C-EA12030A10000	1211502
1,350 mm	C4C-SA13530A10000	1211503	C4C-EA13530A10000	1211504
1,500 mm	C4C-SA15030A10000	1211505	C4C-EA15030A10000	1211506
1,650 mm	C4C-SA16530A10000	1211507	C4C-EA16530A10000	1211508
1,800 mm	C4C-SA18030A10000	1211509	C4C-EA18030A10000	1211510
1,950 mm	C4C-SA19530A10000	1211511	C4C-EA19530A10000	1211512
2,100 mm	C4C-SA21030A10000	1211513	C4C-EA21030A10000	1211514

<sup>1)</sup> The DSL-6182G01M034KM1 connecting cable (female connector M26 / male connector M12) should be used to connect multiple light beam safety devices to the Flexi Loop.

## deTec2 Core

deTec2 Core scope of delivery:

- Safety light curtain consisting of a sender and a receiver
- 4 QuickFix brackets
- Test rod with diameter corresponding to the resolution of the safety light curtain
- Operating instructions on CD-ROM
- Sticker with notes on daily thorough check

<b>Use</b>	As single system
<b>Connections/ports</b>	
System connection	M12, 5-pin
<b>Type according to IEC 61496</b>	Type 2

- **Resolution:** 14 mm
- **Scanning range:** 0 m ... 7 m

Protective field height	Sender		Receiver	
	Type	Part no.	Type	Part no.
300 mm	C2C-SA03010A10000	1213163	C2C-EA03010A10000	1213188
450 mm	C2C-SA04510A10000	1213189	C2C-EA04510A10000	1213190
600 mm	C2C-SA06010A10000	1213191	C2C-EA06010A10000	1213192
750 mm	C2C-SA07510A10000	1213193	C2C-EA07510A10000	1213194
900 mm	C2C-SA09010A10000	1213195	C2C-EA09010A10000	1213196
1,050 mm	C2C-SA10510A10000	1213197	C2C-EA10510A10000	1213198
1,200 mm	C2C-SA12010A10000	1213183	C2C-EA12010A10000	1213199

- **Resolution:** 30 mm
- **Scanning range:** 0 m ... 10 m

Protective field height	Sender		Receiver	
	Type	Part no.	Type	Part no.
300 mm	C2C-SA03030A10000	1213200	C2C-EA03030A10000	1213184
450 mm	C2C-SA04530A10000	1213202	C2C-EA04530A10000	1213203
600 mm	C2C-SA06030A10000	1213204	C2C-EA06030A10000	1213205
750 mm	C2C-SA07530A10000	1213206	C2C-EA07530A10000	1213207
900 mm	C2C-SA09030A10000	1213208	C2C-EA09030A10000	1213209
1,050 mm	C2C-SA10530A10000	1213210	C2C-EA10530A10000	1213211
1,200 mm	C2C-SA12030A10000	1213212	C2C-EA12030A10000	1213213
1,350 mm	C2C-SA13530A10000	1213214	C2C-EA13530A10000	1213215
1,500 mm	C2C-SA15030A10000	1213216	C2C-EA15030A10000	1213217
1,650 mm	C2C-SA16530A10000	1213218	C2C-EA16530A10000	1213219
1,800 mm	C2C-SA18030A10000	1213220	C2C-EA18030A10000	1213221
1,950 mm	C2C-SA19530A10000	1213222	C2C-EA19530A10000	1213223
2,100 mm	C2C-SA21030A10000	1213201	C2C-EA21030A10000	1213164

Multiple light beam safety devices (Flexi Loop-ready <sup>1)</sup>)

M4000 Advanced Curtain



M4000 Advanced Curtain scope of delivery:

- Safety light curtain consisting of a sender and a receiver
- 8 sliding nuts for side bracket
- Test rod with diameter corresponding to the resolution of the safety light curtain
- Operating instructions and CDS (Configuration & Diagnostic Software) on DVD
- Sticker with notes on daily thorough check

<b>Use</b>	As single system
<b>Connections/ports</b>	
System connection	Hirschmann M26 male connector, 12-pin
Extension connection	Male connector, M12, 5-pin
Configuration connection	Female connector, M8, 4-pin

- **Resolution:** 14 mm
- **Scanning range:** 0 m ... 8 m

Protective field height	Sender		Receiver	
	Type	Part no.	Type	Part no.
300 mm	M40S-60A503AAO	1203262	M40E-60A503RB0	1203263
450 mm	M40S-61A503AAO	1203264	M40E-61A503RB0	1203265
600 mm	M40S-62A503AAO	1203266	M40E-62A503RB0	1203267
750 mm	M40S-63A503AAO	1203240	M40E-63A503RB0	1203241
900 mm	M40S-64A503AAO	1203268	M40E-64A503RB0	1203269
1,050 mm	M40S-65A503AAO	1203270	M40E-65A503RB0	1203271
1,350 mm	M40S-67A503AAO	1203274	M40E-67A503RB0	1203275
1,200 mm	M40S-66A503AAO	1203272	M40E-66A503RB0	1203273
1,500 mm	M40S-68A503AAO	1203276	M40E-68A503RB0	1203277
1,650 mm	M40S-69A503AAO	1203278	M40E-69A503RB0	1203279
1,800 mm	M40S-70A503AAO	1203250	M40E-70A503RB0	1203280

- **Resolution:** 30 mm
- **Scanning range:** 0 m ... 19 m

Protective field height	Sender		Receiver	
	Type	Part no.	Type	Part no.
300 mm	M40S-60A303AAO	1201570	M40E-60A303RB0	1201572
450 mm	M40S-61A303AAO	1201127	M40E-61A303RB0	1201214
600 mm	M40S-62A303AAO	1201463	M40E-62A303RB0	1201464
750 mm	M40S-63A303AAO	1201571	M40E-63A303RB0	1201573
900 mm	M40S-64A303AAO	1201441	M40E-64A303RB0	1201442
1,050 mm	M40S-65A303AAO	1201482	M40E-65A303RB0	1201483
1,200 mm	M40S-66A303AAO	1201036	M40E-66A303RB0	1201035
1,350 mm	M40S-67A303AAO	1203236	M40E-67A303RB0	1203242
1,500 mm	M40S-68A303AAO	1203237	M40E-68A303RB0	1203243
1,650 mm	M40S-69A303AAO	1203238	M40E-69A303RB0	1203244
1,800 mm	M40S-70A303AAO	1203239	M40E-70A303RB0	1203245

M4000 Advanced Curtain with end cap with integrated LED

Use	As single system
Connections/ports	
System connection	Hirschmann M26 male connector, 12-pin
Extension connection	Male connector, M12, 5-pin
Configuration connection	Female connector, M8, 4-pin



- **Resolution:** 14 mm
- **Scanning range:** 0 m ... 8 m

Protective field height	Sender		Receiver	
	Type	Part no.	Type	Part no.
300 mm	M40S-60A503AA0	1203262	M40E-60A523RB0	1205622
450 mm	M40S-61A503AA0	1203264	M40E-61A523RB0	1205623
600 mm	M40S-62A503AA0	1203266	M40E-62A523RB0	1205625
750 mm	M40S-63A503AA0	1203240	M40E-63A523RB0	1205303
900 mm	M40S-64A503AA0	1203268	M40E-64A523RB0	1205626
1,050 mm	M40S-65A503AA0	1203270	M40E-65A523RB0	1205627
1,200 mm	M40S-66A503AA0	1203272	M40E-66A523RB0	1204827
1,350 mm	M40S-67A503AA0	1203274	M40E-67A523RB0	1205628
1,500 mm	M40S-68A503AA0	1203276	M40E-68A523RB0	1203511
1,650 mm	M40S-69A503AA0	1203278	M40E-69A523RB0	1205629
1,800 mm	M40S-70A503AA0	1203250	M40E-70A523RB0	1204828

- **Resolution:** 30 mm
- **Scanning range:** 0 m ... 19 m

Protective field height	Sender		Receiver	
	Type	Part no.	Type	Part no.
300 mm	M40S-60A303AA0	1201570	M40E-60A323RB0	1205630
450 mm	M40S-61A303AA0	1201127	M40E-61A323RB0	1205631
600 mm	M40S-62A303AA0	1201463	M40E-62A323RB0	1204362
750 mm	M40S-63A303AA0	1201571	M40E-63A323RB0	1205392
900 mm	M40S-64A303AA0	1201441	M40E-64A323RB0	1204680
1,050 mm	M40S-65A303AA0	1201482	M40E-65A323RB0	1205632
1,200 mm	M40S-66A303AA0	1201036	M40E-66A323RB0	1204764
1,350 mm	M40S-67A303AA0	1203236	M40E-67A323RB0	1205633
1,500 mm	M40S-68A303AA0	1203237	M40E-68A323RB0	1204598
1,650 mm	M40S-69A303AA0	1203238	M40E-69A323RB0	1205634
1,800 mm	M40S-70A303AA0	1203239	M40E-70A323RB0	1204829

Recommended accessories

Figure	Description	Type	Part no.
	UE403 muting switching amplifier	UE403-A0930	1026287
	Connection cable for connecting the system connection to a Flexi Loop node Female connector, M26, 12-pin, straight/male connector, M12, 5-pin, straight, PUR, halogen-free 1 m	DSL-6182G01M034KM1	2072829

M4000 Advanced

M4000 Advanced scope of delivery:

- Multiple light beam safety device consisting of a sender and a receiver
- 8 sliding nuts for side bracket
- Operating instructions and CDS (Configuration & Diagnostic Software) on DVD
- Sticker with notes on daily thorough check



- **Scanning range:** 0.5 m ... 70 m, configurable

Number of beams	Beam separation	Sender		Receiver	
		Type	Part no.	Type	Part no.
2	500 mm	M40S-025003AAO	1200060	M40E-025003RBO	1200065
	600 mm	M40S-026003AAO	1200070	M40E-026003RBO	1200096
3	220 mm	M40S-032203AAO	1200063	M40E-032203RBO	1200097
	400 mm	M40S-034003AAO	1200061	M40E-034003RBO	1200064
	450 mm	M40S-034503AAO	1200071	M40E-034503RBO	1200098
4	220 mm	M40S-042203AAO	1200072	M40E-042203RBO	1200099
	300 mm	M40S-043003AAO	1200073	M40E-043003RBO	1200100
5	220 mm	M40S-052203AAO	1200074	M40E-052203RBO	1200101
6	220 mm	M40S-062203AAO	1200075	M40E-062203RBO	1200102
7	220 mm	M40S-072203AAO	1200076	M40E-072203RBO	1200103
8	220 mm	M40S-082203AAO	1200077	M40E-082203RBO	1200104

M4000 Advanced with integrated alignment aid

- **Scanning range:** 0.5 m ... 70 m, configurable

Number of beams	Beam separation	Sender		Receiver	
		Type	Part no.	Type	Part no.
2	500 mm	M40S-025013AAO	1200057	M40E-025013RBO	1200058
	600 mm	M40S-026013AAO	1200078	M40E-026013RBO	1200105
3	400 mm	M40S-034013AAO	1200069	M40E-034013RBO	1200106
	450 mm	M40S-034513AAO	1200082	M40E-034513RBO	1200107
4	300 mm	M40S-043013AAO	1200080	M40E-043013RBO	1200108

## M4000 Advanced with end cap with integrated LED

- **Scanning range:** 0.5 m ... 70 m, configurable



Number of beams	Beam separation	Sender		Receiver	
		Type	Part no.	Type	Part no.
2	500 mm	M40S-025003AA0	1200060	M40E-025023RB0	1200062
	600 mm	M40S-026003AA0	1200070	M40E-026023RB0	1200079
3	220 mm	M40S-032203AA0	1200063	M40E-032223RB0	1200066
	400 mm	M40S-034003AA0	1200061	M40E-034023RB0	1200067
	450 mm	M40S-034503AA0	1200071	M40E-034523RB0	1200081
4	220 mm	M40S-042203AA0	1200072	M40E-042223RB0	1210279
	300 mm	M40S-043003AA0	1200073	M40E-043023RB0	1200109
5	220 mm	M40S-052203AA0	1200074	M40E-052223RB0	1208161
6	220 mm	M40S-062203AA0	1200075	M40E-062223RB0	1203850
7	220 mm	M40S-072203AA0	1200076	M40E-072223RB0	1201247
8	220 mm	M40S-082203AA0	1200077	M40E-082223RB0	1206683

## M4000 Advanced with integrated alignment aid and end cap with integrated LED

- **Scanning range:** 0.5 m ... 70 m, configurable

Number of beams	Beam separation	Sender		Receiver	
		Type	Part no.	Type	Part no.
2	500 mm	M40S-025013AA0	1200057	M40E-025033RB0	1200110
	600 mm	M40S-026013AA0	1200078	M40E-026033RB0	1200111
3	400 mm	M40S-034013AA0	1200069	M40E-034033RB0	1200068
	450 mm	M40S-034513AA0	1200082	M40E-034533RB0	1200112
4	300 mm	M40S-043013AA0	1200080	M40E-043033RB0	1200113

## Recommended accessories

Figure	Description	Type	Part no.
	UE403 muting switching amplifier	UE403-A0930	1026287
	Connection cable for connecting the system connection to a Flexi Loop node Female connector, M26, 12-pin, straight/male connector, M12, 5-pin, straight, PUR, halogen-free 1 m	DSL-6182G01M034KM1	2072829

## FAULT MASKING IN SERIES CONNECTION OF INTERLOCKING DEVICES WITH VOLT-FREE CONTACTS

Standard EN ISO 14119 and technical report ISO TR 24119 define, among others, the requirements on the logical series connection of position switches (called safety switches in the remainder of the document). The risk of possible “fault masking” in the conventional series connection of the safety switches with volt-free contacts limits the performance level that can be achieved and, in some applications, makes such a series connection inadmissible.

Fault masking can occur in series connection of switches with volt-free contacts. Since the evaluation unit only evaluates the signals of the complete series, fault detection can be prevented. The fault, e.g. a short-circuit or cross-circuit, is either not detected at all due to actuation of another protective device with a safety switch, or is reset (masked) after detection. This means that operation of dangerous machine functions is possible despite the presence of an isolated fault. The accumulation of masked faults may then lead to the loss of the safety function.

### Example for the development of fault masking

- 1 Initial fault occurs (e.g. short-circuit at safety switch 2 due to cable damage)
- 2 The faulty safety switch is activated (protective door 2<sup>1)</sup> is opened, then closed)
- 3 The evaluation unit detects a discrepancy, switches off and goes into lockout mode (reset not possible)
- 4 During troubleshooting, another safety switch is actuated (protective door 3<sup>1)</sup> is opened, then closed). Since this safety switch does not have a pending fault, the two channels are shut off synchronously. A discrepancy is no longer present.
- 5 The input requirements of the evaluation unit are fulfilled: The evaluation unit is reset, masking the initial fault.  
→ Resetting the evaluation unit enables operation of dangerous machine function while an isolated fault still exists.
- 6 An additional fault on the other channel (e.g. due to additional cable damage) results in loss of the safety function (e.g. when opening protective door 2<sup>1)</sup>, the evaluation unit would not signal a stop command).

<sup>1)</sup> The term “protective door” is used in this document instead of the term “movable physical guard” used in the standard.

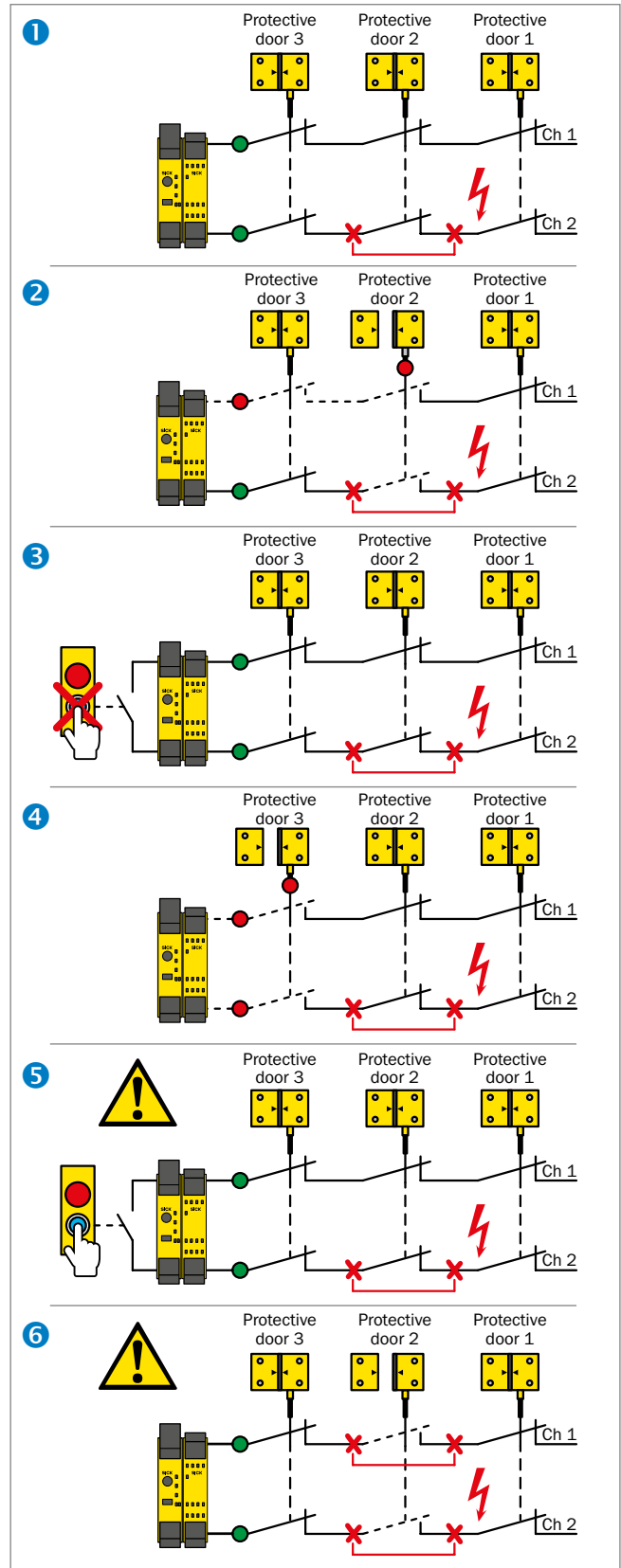



If it is assumed that, during the foreseeable troubleshooting, one of the movable physical guards (e.g. protective door, maintenance flap) is operated by the machine operator and the fault is masked thereby, the corresponding reduction in the

diagnostic coverage DC (fault recognition rate) has to be taken into account (see table 1). This may lead to the performance level being reduced to PL d or PL c (see table 2).

Number of frequently-used <sup>1)</sup> protective doors	Number of additional protective doors	Maximum achieved diagnostic coverage (DC) <sup>2)</sup>
0	2 ... 4	Medium
0	5 ... 30	Low
0	> 30	None
1	1	Medium
1	2 ... 4	Low
1	≥ 5	None
> 1	≥ 0	None

Source: ISO/DTR 24119

<sup>1)</sup> Frequent = More than 1 opening per hour.

<sup>2)</sup> If it can be expected that, during normal operation, several doors will be open at the same time (e.g. with swing doors of when the machine is operated by several people at the same time), meaning a fault could be masked, diagnostic coverage DC must be limited to "None".

Table 1 - Simplified process for calculating the maximum achievable DC.

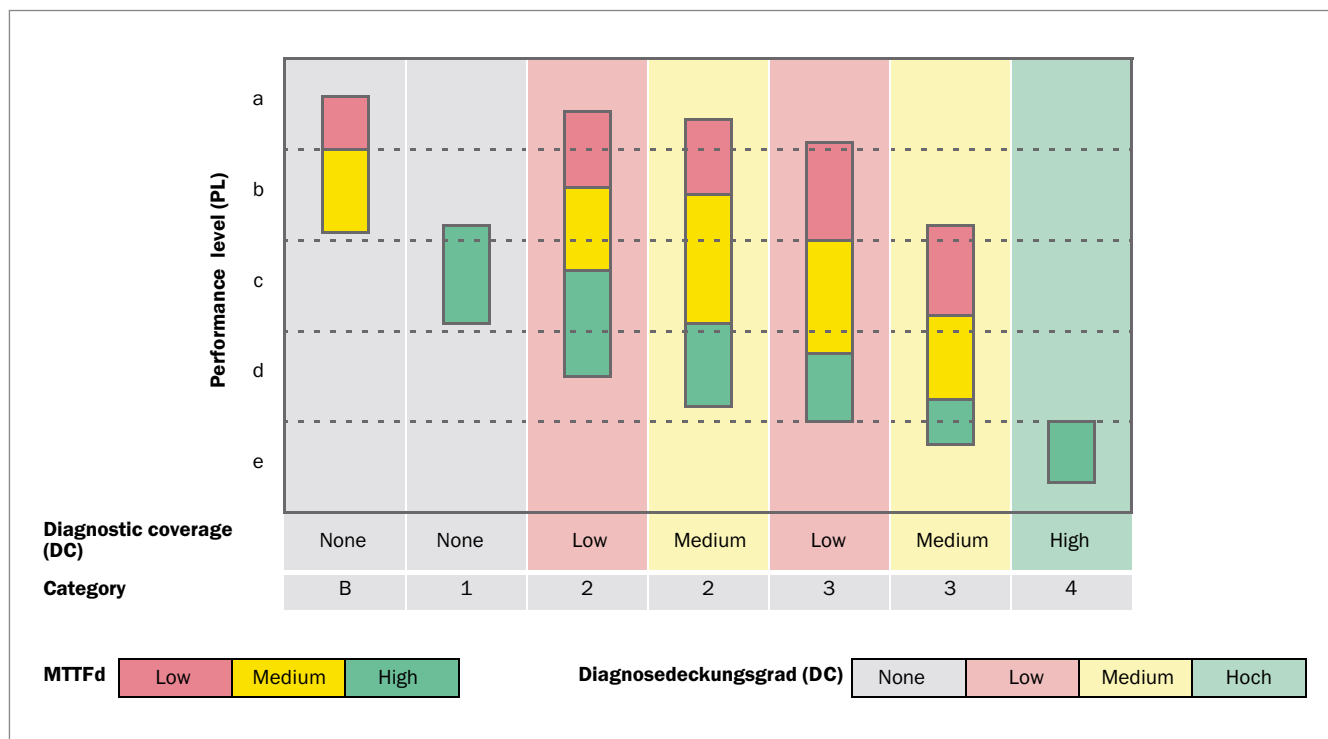

Source of graphics: Guide for Safe Machinery, 4/23/2014, p. 3-80

Table 2 - Determining the PL of a subsystem. The following figure shows the relationship between the MTTFd value (per channel), the DC, and the category in connection with suitable evaluation unit, e.g. Flexi Classic/Flexi Soft.



# FAULT MASKING – EXAMPLE 1

Series connection of 4 magnetic safety switches

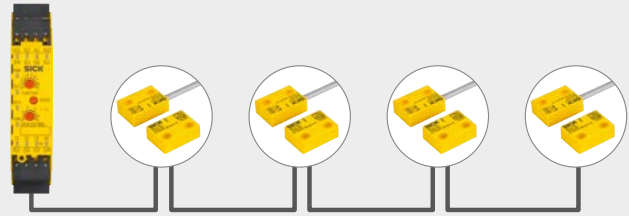

### 1 Calculation of MTTFd

- **MTTFd (overall) = High**
  - Calculated from the actuation frequency of the individual protective doors, the total switching frequency of the evaluation unit and  $B10_d$  values of the devices used

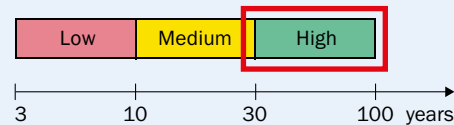

### 2 Calculation of diagnostic coverage (DC)

- **Diagnostic coverage (DC) = Medium**
  - With 4 magnetic safety switches connected in series which are actuated less than once per hour

Number of additional protective doors	Number of frequently-used protective doors	Maximum achieved diagnostic coverage (DC)
2 ... 4	0	Medium
≥ 0	> 1	None

### 3 Category determination

- **Category 3 or category 4**
  - The safety switches are connected as dual-channel, category 3 or category 4 with sufficient measures against failures resulting from a mutual cause (CCF)



→ Maximum achievable performance level = PL e, when the protective doors are used frequently = max. PL c

When the number of safety switches in the cascade is small and under certain conditions (type of wiring, low frequency of actuation, etc.), the probability of fault masking is still limited. Series connection is therefore still permitted with a high performance level. If, however, it can be expected that, during normal operation, several doors will be open at the same time, meaning a fault could be masked, diagnostic coverage DC must be limited to “None” and the performance level falls to PL c at most.

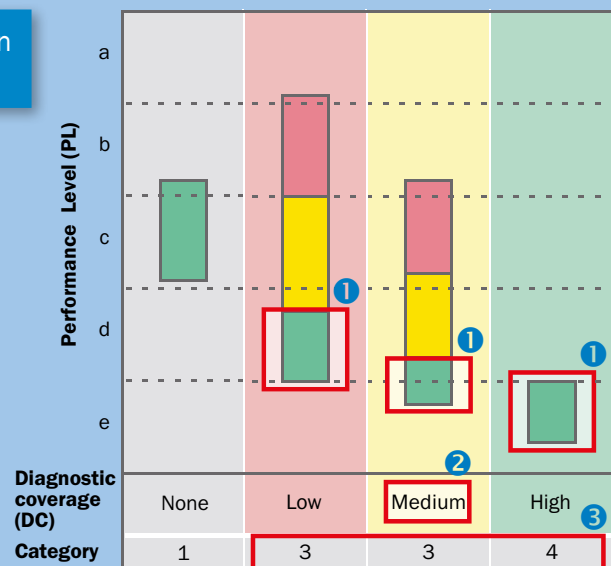

## FAULT MASKING – EXAMPLE 2

Series connection of 5 magnetic safety switches

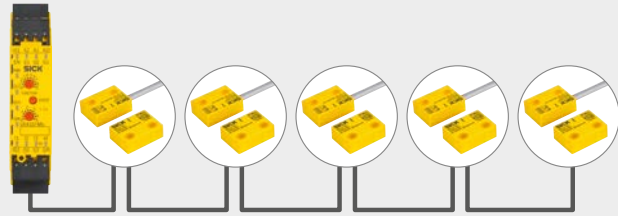

### 1 Calculation of MTTFd

- **MTTFd (overall) = High**
  - Calculated from the actuation frequency of the individual protective doors, the total switching frequency of the evaluation unit and B10<sub>d</sub> values of the devices used

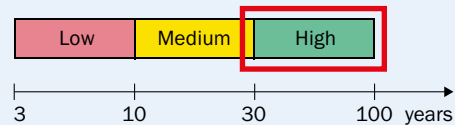

### 2 Calculation of diagnostic coverage (DC)

- **Diagnostic coverage (DC) = Low**
  - With 5 magnetic safety switches connected in series which are actuated less than once per hour

Number of additional protective doors	Number of frequently-used protective doors	Maximum achieved diagnostic coverage (DC)
5 ... 30	0	Low
≥ 0	> 1	None

### 3 Category determination

- **Category 3 or category 4**
  - The safety switches are connected as dual-channel, category 3 or category 4 with sufficient measures against failures resulting from a mutual cause (CCF)



→ Maximum achievable performance level = PL d, when the protective doors are used frequently = max. PL c

As the number of safety switches in the series connection rises, so does the probability of fault masking, which has an influence on the maximum diagnostic coverage achievable. That means that even if the total MTTFd value is high, only performance level PL d can be reached. If, during normal operation, several doors can be open at the same time or if the protective doors are opened more than once per hour, the danger of fault masking is particularly high (diagnostic coverage DC = "None") and the achievable performance level falls to PL c at most.

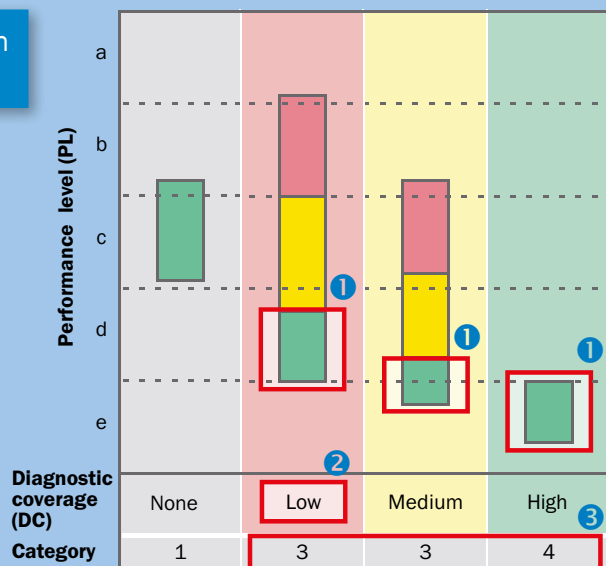

Source of graphics: Guide for Safe Machinery, 4/23/2014, p. 3-80

## B

### B10d

Number of cycles after which a dangerous failure has occurred on 10% of the components (for pneumatic and electro-mechanical components)

## C

### Complementary contacts

The term for 2 different contacts (1 N/C and 1 N/O) for safety-related tasks.

## D

### DC (diagnostic coverage)

Measure of the effectiveness of the diagnostics that can be determined as the ratio of the failure rate of detected dangerous failures to the failure rate of all dangerous failures

## E

### Equivalent contacts

The term for 2 similar contacts (2 N/C or 2 N/O) for safety-related tasks.

## M

### Monitored semiconductor outputs

A monitored semiconductor output is a safety output signal switching device which is periodically tested for faultless function.

### Movable physical guard

Physical barrier which is designed as part of the machine to provide protection (physical guard) and can be opened without the use of tools. Generally, the position of these guards is monitored by locking devices (e.g. comprising position switches) in order to prevent the operation of dangerous machine functions when the guard is opened.

### MTTFd (mean time to failure)

Expected value for the mean time to dangerous failure (ISO 13849-1/EN ISO 13849-1)

## P

### PFHd (probability of dangerous failure per hour)

Mean probability of a dangerous failure per hour (1/h).

### PL (performance level)

Discrete level used to specify the ability of the safety-related parts of a control system to perform a safety function under foreseeable conditions (ISO 13849-1/EN ISO 13849-1)

## S

### Safety function

Function of a machine, the failure of which can result in an immediate increase of the risk(s) (EN ISO 12100-1). A safety function is provided by safety-related parts of control systems (SRP/CS).

## V

### Volt-free contact

Electrical switching element in which, in the connected state (contact closed), the input potential is available at the output due to a conducting connection. When the contact is opened, the flow of current is interrupted. A volt-free contact may be a mechanical switching element (e.g. a reed contact) or an optocoupler.





## REGISTER AT WWW.SICK.COM TO TAKE ADVANTAGE OF OUR FOLLOWING SERVICES FOR YOU





- ✔ Access information on net prices and individual discounts.
- ✔ Easily order online and track your delivery.
- ✔ Check your history of all your orders and quotes.
- ✔ Create, save, and share as many wish lists as you want.
- ✔ Use the direct order to quickly order a big amount of products.
- ✔ Check the status of your orders and quotes and get information on status changes by e-mail.
- ✔ Save time by using past orders.
- ✔ Easily export orders and quotes, suited to your systems.



## SERVICES FOR MACHINES AND PLANTS: SICK LifeTime Services

Our comprehensive and versatile LifeTime Services are the perfect addition to the comprehensive range of products from SICK. The services range from product-independent consulting to traditional product services.



- 
**Consulting and design**  
 Safe and professional
- 
**Product and system support**  
 Reliable, fast, and on-site
- 
**Verification and optimization**  
 Safe and regularly inspected
- 
**Upgrade and retrofits**  
 Easy, safe, and economical
- 
**Training and education**  
 Practical, focused, and professional

## SICK AT A GLANCE

SICK is a leading manufacturer of intelligent sensors and sensor solutions for industrial applications. With more than 8,000 employees and over 50 subsidiaries and equity investments as well as numerous agencies worldwide, we are always close to our customers. A unique range of products and services creates the perfect basis for controlling processes securely and efficiently, protecting individuals from accidents and preventing damage to the environment.

We have extensive experience in various industries and understand their processes and requirements. With intelligent sensors, we can deliver exactly what our customers need. In application centers in Europe, Asia and North America, system solutions are tested and optimized in accordance with customer specifications. All this makes us a reliable supplier and development partner.

Comprehensive services round out our offering: SICK LifeTime Services provide support throughout the machine life cycle and ensure safety and productivity.

**For us, that is “Sensor Intelligence.”**

### **Worldwide presence:**

Australia, Austria, Belgium, Brazil, Canada, Chile, China, Czech Republic, Denmark, Finland, France, Germany, Great Britain, Hungary, India, Israel, Italy, Japan, Malaysia, Mexico, Netherlands, New Zealand, Norway, Poland, Romania, Russia, Singapore, Slovakia, Slovenia, South Africa, South Korea, Spain, Sweden, Switzerland, Taiwan, Thailand, Turkey, United Arab Emirates, USA, Vietnam.

Detailed addresses and further locations → [www.sick.com](http://www.sick.com)