

Nova 2D

SensorApps



Described product

Nova 2D (version 2.7)

Manufacturer

SICK AG
Erwin-Sick-Str. 1
79183 Waldkirch
Germany

Legal information

This work is protected by copyright. Any rights derived from the copyright shall be reserved for SICK AG. Reproduction of this document or parts of this document is only permissible within the limits of the legal determination of Copyright Law. Any modification, abridgment or translation of this document is prohibited without the express written permission of SICK AG.

The trademarks stated in this document are the property of their respective owner.

© SICK AG. All rights reserved.

Original document

This document is an original document of SICK AG.

Contents

1	About this document.....	5
1.1	Information on the operating instructions.....	5
1.2	Explanation of symbols.....	5
1.3	Further information.....	5
2	Safety information.....	7
2.1	Intended use.....	7
2.2	Limitation of liability.....	7
2.3	Modifications and conversions.....	7
2.4	Cybersecurity.....	7
3	Product description.....	9
3.1	Overview.....	9
3.2	Licenses.....	9
3.2.1	Available licenses.....	9
3.3	System requirements.....	10
4	Getting started.....	12
4.1	Connecting the Inspector.....	12
4.2	Connecting camera and SIM.....	13
5	Installation.....	15
5.1	Setting up the Ethernet network.....	15
5.1.1	Setting an IP address on the computer.....	15
5.1.2	Setting an IP address on the device.....	17
5.2	Installing or updating the SensorApp on a device.....	18
5.2.1	Installing the .sapk file using SICK AppManager.....	20
5.3	Activating a license using LicenseManager.....	21
5.3.1	Direct license transfer.....	22
5.3.2	File-based license transfer.....	24
5.4	SICK AppManager.....	29
5.5	SICK AppEngine.....	29
5.6	Installing tools.....	30
6	Operation.....	32
6.1	User interface.....	32
6.1.1	Top menu items.....	33
6.1.2	Tool tree.....	34
6.1.3	Monitoring results and cycle times	35
6.1.4	Monitoring CPU and memory usage.....	36
6.1.5	Image source.....	37
6.1.6	Creating and switching jobs.....	39
6.2	Permissions and user level access.....	40
6.2.1	Logging in.....	40
6.2.2	Change password.....	41

6.3	Editing the image acquisition settings.....	42
6.3.1	Working with an Inspector device.....	42
6.3.2	Working with a picoCam2 or midiCam2.....	44
6.4	Setting the region of interest for a tool.....	45
6.5	Configure mode.....	46
6.5.1	Saving, importing and exporting a configuration.....	47
6.6	System settings.....	48
6.6.1	Interfaces tools.....	48
6.6.2	Calibration tools.....	56
6.7	Job settings.....	57
6.7.1	Analysis tools.....	57
6.7.2	Results tools.....	85
6.7.3	Communication tools.....	92
6.8	Run mode.....	101
6.9	License handling.....	101
6.9.1	Indicating the need of a license.....	102
6.9.2	Activation of Intelligent Inspection Upgrade License.....	103
7	Annex.....	104
7.1	Third party licenses.....	104
7.2	Standard plug-in tools.....	104
7.2.1	Analysis tools.....	104

1 About this document

1.1 Information on the operating instructions

These operating instructions provide important information on how to use products from SICK AG. Prerequisites for safe work are:

- Compliance with all safety notes and handling instructions supplied.
- Compliance with local work safety regulations and general safety regulations for product applications .

The operating instructions are intended to be used by qualified personnel.



NOTE

Read these operating instructions carefully before starting any work, in order to familiarize yourself with the product and its function.

The instructions constitute an integral part of the product and must be accessible to staff at all times.

These operating instructions do not provide information on operating the machine or system in which the product is integrated. For information about this, refer to the operating instructions of the specific machine.

1.2 Explanation of symbols

Warnings and important information in this document are labeled with symbols. The warnings are introduced by signal words that indicate the extent of the danger. These warnings must be observed at all times and care must be taken to avoid accidents, personal injury, and material damage.



DANGER

... indicates a situation of imminent danger, which will lead to a fatality or serious injuries if not prevented.



WARNING

... indicates a potentially dangerous situation, which may lead to a fatality or serious injuries if not prevented.



CAUTION

... indicates a potentially dangerous situation, which may lead to minor/slight injuries if not prevented.



NOTICE

... indicates a potentially harmful situation, which may lead to material damage if not prevented.



NOTE

... highlights useful tips and recommendations as well as information for efficient and trouble-free operation.

1.3 Further information

More information can be found on the product page.

The page can be accessed via the SICK Product ID: pid.sick.com/{P/N}/{S/N}

{P/N} corresponds to the part number of the product, see type label.

{S/N} corresponds to the serial number of the product, see type label (if indicated).

The following information is available depending on the product:

- Data sheets
- This document in all available language versions
- CAD files and dimensional drawings
- Certificates (e.g., declaration of conformity)
- Other publications
- Software
- Accessories

2 Safety information

2.1 Intended use

Nova 2D is a SensorApp for the InspectorP6xx and Inspector8xx families of 2D cameras and for the SIM2x00 in combination with picoCam2 or midiCam2 cameras. Nova 2D is the common name for two similar SensorApps used on InspectorP6xx, Inspector8xx and SIM2x00.

The SensorApp enables vision-based quality inspection by applying embedded image analysis tools to images acquired by the camera. The results are sent to a control system via external interfaces. Different licenses makes different toolsets available for productive use.

2.2 Limitation of liability

Relevant standards and regulations, the latest technological developments, and our many years of knowledge and experience have all been taken into account when compiling the data and information contained in these operating instructions. The manufacturer accepts no liability for damage caused by:

- Non-adherence to the product documentation (e.g., operating instructions)
- Incorrect use
- Use of untrained staff
- Unauthorized conversions or repair
- Technical modifications
- Use of unauthorized spare parts, consumables, and accessories

2.3 Modifications and conversions



NOTICE

Modifications and conversions to the device may result in unforeseeable dangers.

Interrupting or modifying the device or SICK software will invalidate any warranty claims against SICK AG. This applies in particular to opening the housing, even as part of mounting and electrical installation.

2.4 Cybersecurity

Overview

To protect against cybersecurity threats, it is necessary to continuously monitor and maintain a comprehensive cybersecurity concept. A suitable concept consists of organizational, technical, procedural, electronic, and physical levels of defense and considers suitable measures for different types of risks. The measures implemented in this product can only support protection against cybersecurity threats if the product is used as part of such a concept.

You will find further information at www.sick.com/psirt, e.g.:

- General information on cybersecurity
- Contact option for reporting vulnerabilities
- Information on known vulnerabilities (security advisories)

Device capabilities and recommended use

As the device typically uses network communication extensively, please note the following when designing a cybersecurity concept for the system this device shall be part of:

- When correctly configured, the Nova 2D SensorApp offers basic authentication for the GUI to prevent unintentional or accidental misuse. However, the underlying browser-to-device communication is not authenticated.
- All communication (images, configuration, logs) between the device and network devices (e.g. a computer used for configuration), should be assumed to be unencrypted unless otherwise specified.
- It is recommended to always use the latest software to ensure that the latest security patches are applied.
- It is recommended to only connect the device to private isolated networks. At all points where there is a physical connection to external, possibly untrusted networks, it is strongly recommended to block all network traffic to and from the device using a firewall.
- A user who develops custom software running on the device (i.e. development in SICK AppSpace) is responsible for the security of the developed solution. For example, the web-based CROWN interface does not offer any authentication, and should be disabled when possible for increased security. For more information, see the SICK AppSpace Security Concepts document: supportportal.sick.com/Product_notes/sick-appspace-security-concepts/.

3 Product description

3.1 Overview

The Nova 2D SensorApp is configured through a web-based graphical user interface, which contains a selection of software tools for image analysis, result output, and communication. The SensorApp is available for both InspectorP6xx, Inspector8xx¹⁾ and SIM2x00²⁾. The tools are listed and described in [System settings](#) and [Job settings](#).

Quality Inspection toolset



The Quality Inspection toolset uses vision-based quality inspection to ensure that produced items have the exact qualities required regarding presence and measurements of details.

Intelligent Inspection toolset



The deep learning-powered Intelligent Inspection toolset enables powerful anomaly detection and object classification that is not possible with rule-based machine vision. The combination of an example-based approach with on-device training and user-friendly interface paves the way for simplified solution development.

The anomaly detection and classification tools ensure that inspected items fulfill required quality and sorting demands, which help to improve yield, reduce waste and increase customer satisfaction. In addition, all traditional rule-based machine vision software tools from Quality Inspection toolset are included.

3.2 Licenses

3.2.1 Available licenses

The Quality Inspection License is pre-activated on the InspectorP6xx and Inspector8xx devices (not possible to relocate to other device). The Intelligent Inspection Upgrade License (possible to relocate) can be purchased separately to productively use the complete set of tools.

The licenses can be purchased separately for use with Nova SIM 2D on SIM2x00, and all are possible to relocate to other device. SIM2x00 with pre-installed SensorApp and pre-activated license is available for purchase. There is a link to where a license is available for purchase, right next to the download button for the SensorApp on SICK AppPool, <http://apppool.cloud.sick.com/>.

For details about the different licensed toolsets, see "[Tools included per license](#)", page 9.

3.2.1.1 Tools included per license

Tools	Quality Inspection	Intelligent Inspection
Object Locator	✓	✓
Blob Finder	✓	✓
Blob Finder Color	✓	✓
Edge Pixel Counter	✓	✓
Pixel Counter	✓	✓
Pixel Counter Color	✓	✓

1) Nova Inspector.sapk

2) Nova SIM 2D.sapk

Tools	Quality Inspection	Intelligent Inspection
Angle	✓	✓
Bead	✓	✓
Blob Locator	✓	✓
Blob Locator Color	✓	✓
Circle Fitter	✓	✓
Distance	✓	✓
Ellipse Fitter	✓	✓
Fixed Line	✓	✓
Fixed Point	✓	✓
Line Fitter	✓	✓
Pattern Locator	✓	✓
AI Anomaly Detection	2-hour trial period	✓
AI Classification	2-hour trial period	✓
AI Classification (dStudio)	2-hour trial period	✓

In addition to the tools that are included for a specific license, the Nova 2D SensorApp supports the creation and import of additional tools. For a description of how to import a tool through SICK AppManager, see "Installing tools", page 30. A tutorial for tool development is available from the SICK Support Portal, supportportal.sick.com.

3.3 System requirements

Hardware

The following devices support the use of Nova 2D SensorApp. A trial period of 2-hours per reboot is enabled for the Intelligent Inspection toolset when installing the Nova 2D SensorApp without license activated. For more information about license handling, see "License handling", page 101.

- InspectorP611
- InspectorP621
- InspectorP631
- InspectorP632
- InspectorP642
- InspectorP652
- InspectorP654
- Inspector83x
- Inspector85x
- SIM2000
- SIM2500
- SICK AppStudio Emulator (full featured)¹⁾
- SICK AppEngine (as emulator)¹⁾

¹⁾ Cannot be used for all tools.

Software

- The SICK AppManager software (www.sick.com/SICK_AppManager) is required for installing or updating the SensorApp on a device.
- The web-based dStudio software (<https://dstudio.cloud.sick.com/>) is required for acquiring a trained neural network to be used for the Deep Learning-based image classification.

- The SICK AppStudio (www.sick.com/SICK_AppStudio) is required for custom tool development.
- The SICK AppEngine (www.sick.com/SICK_AppSpace) can be used as an emulator.

Firmware

- InspectorP6xx firmware, SIM2x00 firmware, or SICK AppEngine is required to run the SensorApp. Supported firmware version available via SICK Support Portal, supportportal.sick.com.

Supported web browsers

- Google Chrome
- Microsoft Edge

4 Getting started



NOTE

Before using the product in a production environment, the complete operating instructions must have been read and understood.

4.1 Connecting the Inspector

For an overview of the electrical connections for the installation, see the respective Operating Instructions for the devices. The photoelectric sensor, external illumination, and connection module are optional accessories.



NOTE

Preset IP addresses of the Ethernet interfaces:

- Ethernet (default): 192.168.0.1
- USB-C: 169.254.0.1

When using USB-C, you can usually access the device at 169.254.0.1 without any configuration.

InspectorP6xx

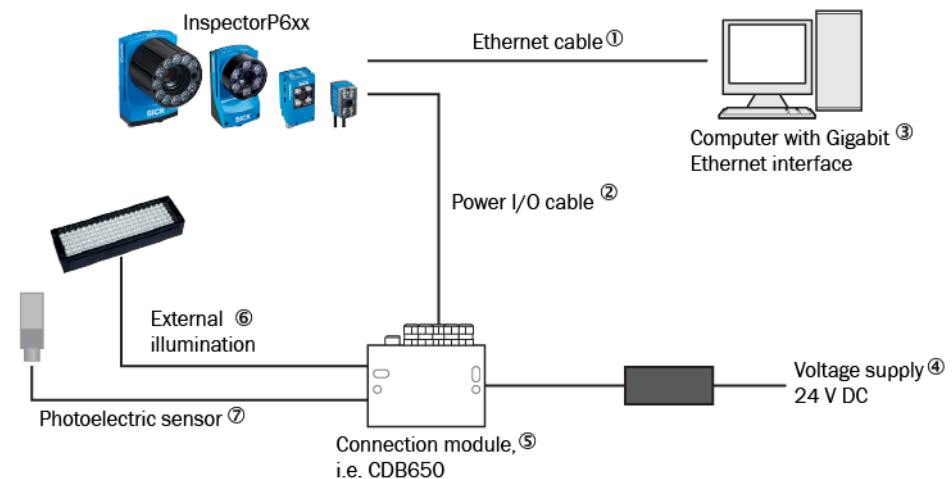

Figure 1: Connecting an InspectorP6xx device

- ① Device
- ② Ethernet cable
- ③ Power I/O cable
- ④ Computer with Gigabit Ethernet interface
- ⑤ Voltage supply 24 V DC
- ⑥ Connection module, i.e. CDB650
- ⑦ External illumination
- ⑧ Photoelectric sensor

Inspector8xx



NOTE

The USB interface is recommended for easy setup and used for test, demo, and commissioning. The Gigabit Ethernet must be used for any permanent installation.

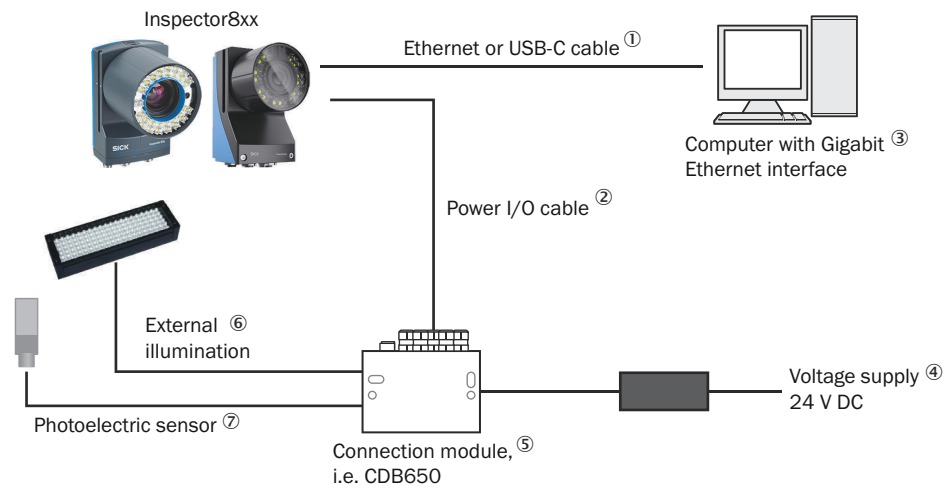

Figure 2: Connecting an Inspector8xx device

- ① Ethernet or USB-C cable
- ② Power I/O cable
- ③ Computer with Gigabit Ethernet interface
- ④ Voltage supply 24 V DC
- ⑤ Connection module, i.e. CDB650
- ⑥ External illumination
- ⑦ Photoelectric sensor

4.2 Connecting camera and SIM

For an overview of the electrical connections for the installation, see the respective Operating Instructions for the devices.



NOTE

Preset IP addresses of the Ethernet interfaces:

- Ethernet 1: 192.168.0.1
- Ethernet 2: 192.168.1.1
- Ethernet 3: 192.168.2.1
- Ethernet 4: 192.168.3.1

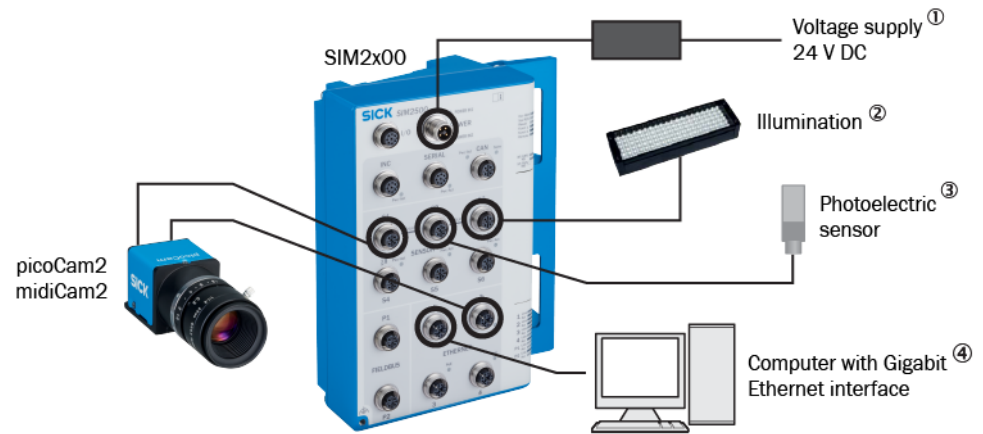

Figure 3: Connecting a camera and SIM2x00

- ① Voltage supply 24 V DC
- ② Illumination
- ③ Photoelectric sensor
- ④ Computer with Gigabit Ethernet interface



WARNING

If the camera is connected to both an S connector and an Ethernet connector, do not enable power on both connectors. The camera can be damaged.

5 Installation

By default, the Nova 2D SensorApp is pre-installed on the InspectorP6xx³⁾ devices. The Quality Inspection License is pre-activated and not possible to relocate to another device.

The Nova 2D SensorApp for Inspector85x³⁾ and SIM2x00⁴⁾ are available for download and installation via SICK AppPool (<http://apppool.cloud.sick.com/>). Both Inspector85x and SIM2x00 can also be purchased with Nova 2D SensorApp pre-installed and selected toolset license pre-activated.

The Intelligent Inspection toolset is available by purchase and activation of license. For more information about the available licenses, see "Licenses", page 9.

- To run a pre-installed SensorApp, proceed to "User interface", page 32 for instructions on how to open the user interface.
- To install or update the SensorApp on a device, follow the instructions in "Installing or updating the SensorApp on a device", page 18.
- To start, stop or delete an installed SensorApp, use SICK AppManager (see "SICK AppManager", page 29).
- To install additional tools, see "Installing tools", page 30.

5.1 Setting up the Ethernet network

The Ethernet network must be correctly set up, in order for the computer and device to communicate. The Ethernet network can be a factory or office network, or consist of only the computer and the device.



NOTE

Both the computer and the device must be set up for communication on the same network.

In this example, we connect the device directly to a Windows computer. The network consists of the computer, the device, and the Ethernet cable between them. Set the IP address and the Subnet mask so that each device has a unique IP address. The IP address must still be similar enough to belong to the same network.

5.1.1 Setting an IP address on the computer

If you have more than one Ethernet port, try to disconnect and reconnect the Ethernet cable between the device and computer. You can then identify which connection to adapt.

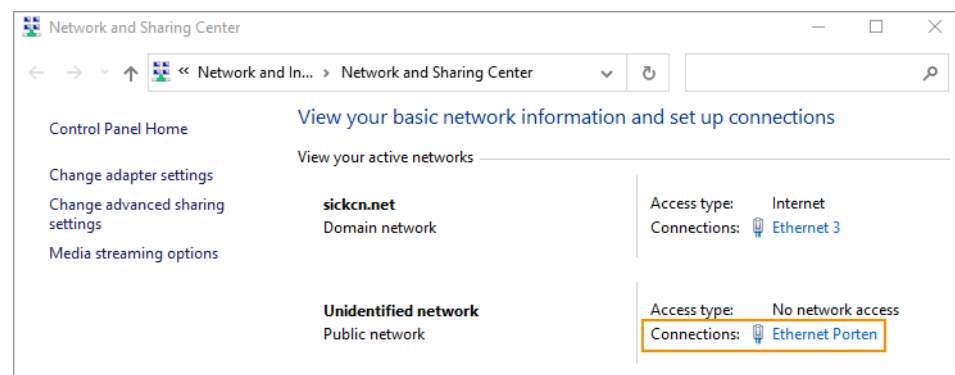

³⁾ Nova Inspector.sapk

⁴⁾ Nova SIM 2D.sapk

**NOTE**

You need to be authorized to change the computer settings.

1. Open the **Network and Sharing Center** on the computer.
2. Click on the link for the appropriate **Connection**.
3. Click on **Properties**.

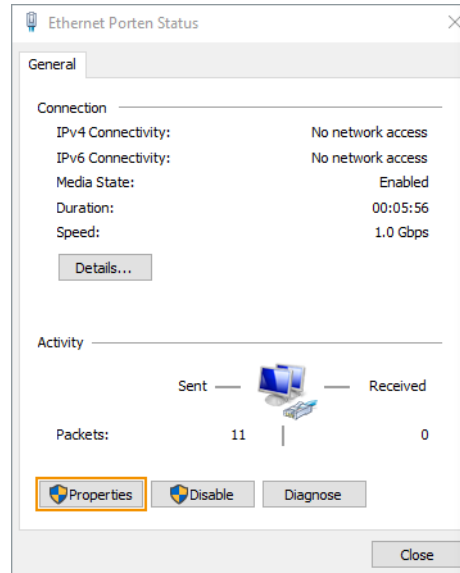

4. Select **Internet Protocol Version 4 (TCP/IPv4)** in the list, and click on **Properties**.

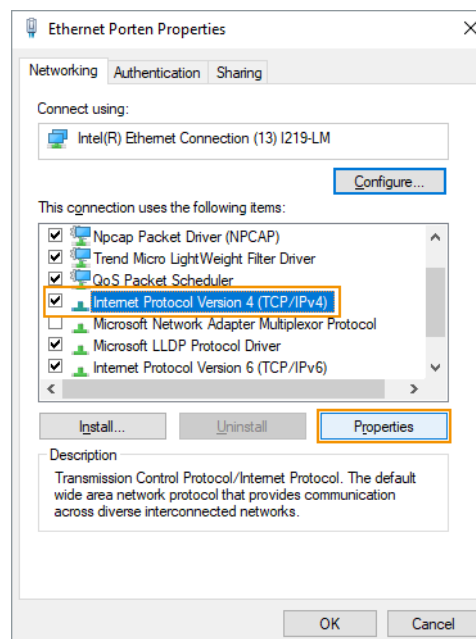

5. A DHCP-server automatically assigns IP addresses to recognized devices on the network. We have to manually assign an **IP address** and a **Subnet mask** to the computer, since there is no DHCP-server. Set the **Subnet mask**. The subnet mask decides the size of the network.

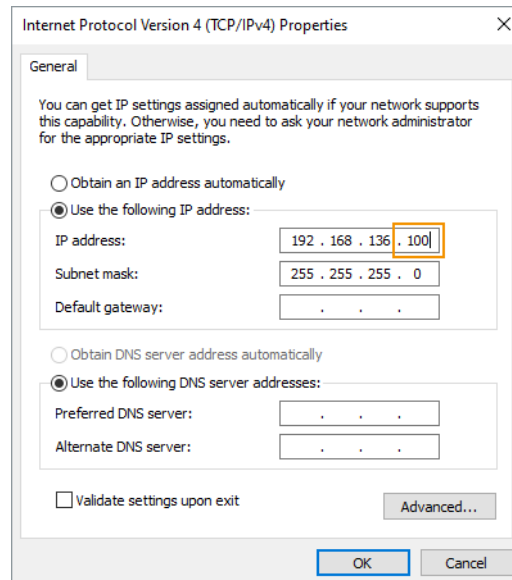

Each position in the subnet mask controls how many possible options that position can have in the corresponding IP address. However, a large number means fewer options and a small number means many possible options. The corresponding formula is:

$$\text{Number of options} = 256 - x$$

255 in a position means that there is only one possible option for that position in the IP-address. 0 means that you have all 256 possible options from 0 to 255 available for that position of the IP-address. 255.255.255.0 is sometimes called a C-network, and is the most commonly used network type. A C-network can, at the most, host 256 devices on the same network.

6. Set the **IP address**. Use the same IP address as the device for the first three sections. The last section in the IP address must be different. In this example, we only have two devices to address. It does not matter what numbers you pick, as long as they all are smaller than 256.
7. Click **OK** and **Close** to complete the settings.



NOTE

If you use the same Ethernet port on your computer for connecting to your home, factory, or office network you have to remember to change back to your original settings in order for that to work when you are done connecting to the device. For that reason, it is usually a good idea to pick IP addresses that are compatible with that network in case you forget.

5.1.2 Setting an IP address on the device

Use the SICK AppManager to find connected devices on the local network, and change the settings on your device. If your device is powered up and connected to the computer when you start SICK AppManager, the device will show up as one or two lines in the **Device search** tab.

1. Open the **SICK AppManager** on the computer.
2. Select the line representing the desired device.

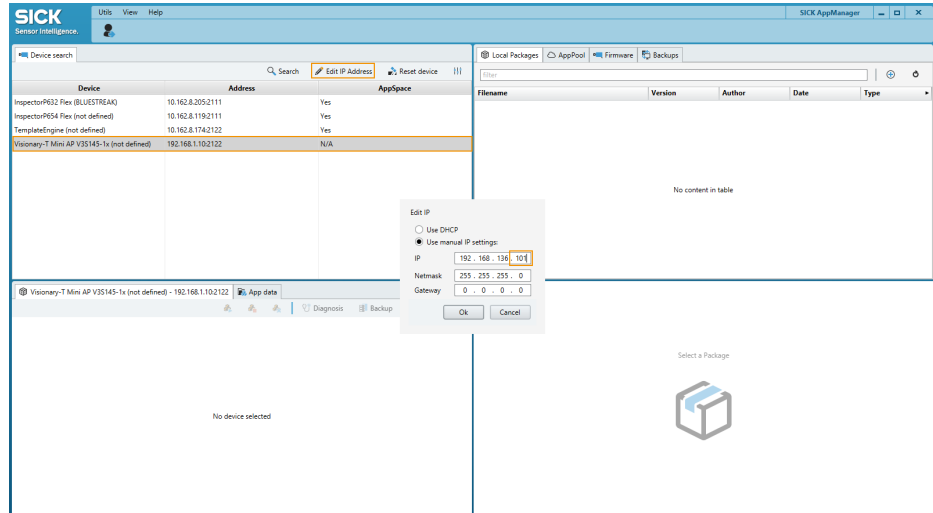

3. Click on **Edit IP Address**.
4. Set the **Netmask**. Enter the same subnet mask as the computer has.
5. Set the **IP**. Use the same IP address as the computer for the first three sections. The last section in the IP address must be different.
6. Click **OK**.

5.2 Installing or updating the SensorApp on a device



The latest version of the Nova 2D SensorApp file (.sapk) is available from SICK AppPool (<http://app-pool.cloud.sick.com/>). The use of SICK AppPool requires a SICK ID, which can be obtained at the login page at the link above.



If the computer has Internet access when connected to the device, the SensorApp can be downloaded and installed directly from SICK AppPool using SICK AppManager. If the computer does not have Internet access when connected to the device, the SensorApp must be downloaded to the computer prior to the installation. See [figure 4](#).

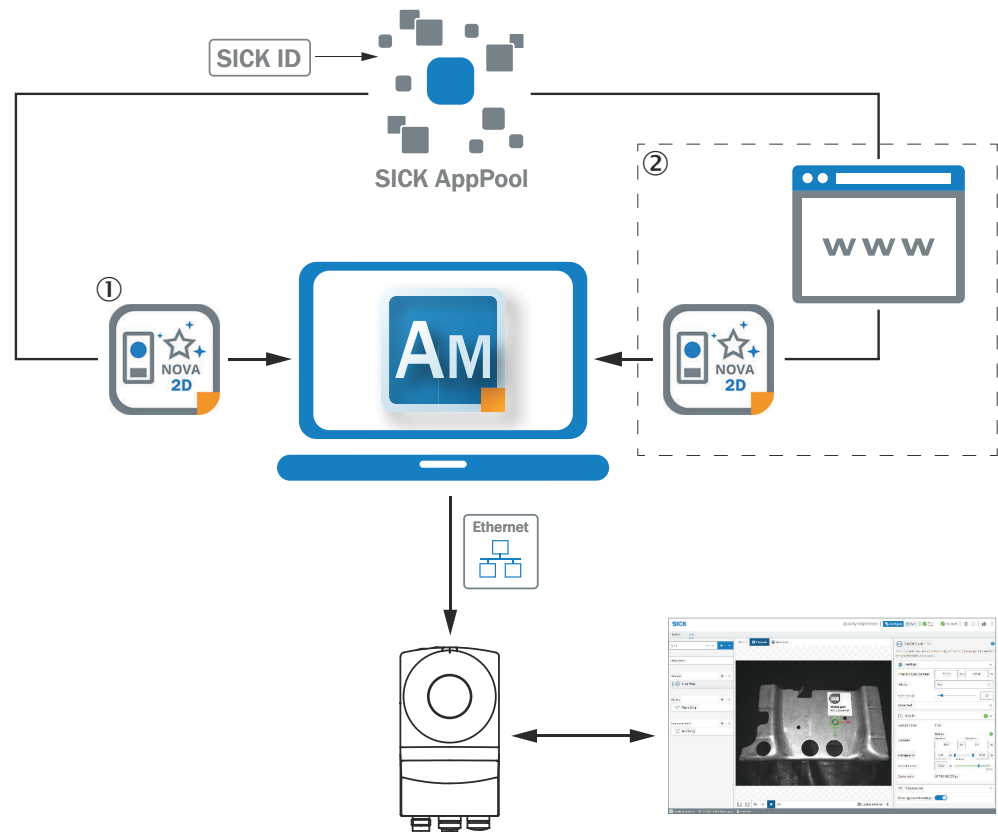

Figure 4: Online and offline solutions for installing a SensorApp via SICK AppManager

- ① Online solution: Download and install the SensorApp directly from SICK AppPool using SICK AppManager
- ② Offline solution: Download the SensorApp from apppool.cloud.sick.com to the computer prior to the installation



NOTE

Before starting the installation, make sure that the network communication settings on the computer are correctly set up:

- The computer must be on the same network as the device.
- The computer must not use the same IP address as the device.

For more information, see "Setting up the Ethernet network", page 15.



NOTE

When upgrading or downgrading Nova 2D SensorApp, the associated configuration file is deleted.

To re-use the existing configuration file, export it before the upgrade or downgrade and re-import it after.

To install the Nova 2D SensorApp using SICK AppManager:

1. Connect the device to the computer via Ethernet.
2. On the computer, open SICK AppManager.
3. Under the **Device Search** tab in SICK AppManager, click **Search** to search for available devices on the network.
4. In the list of available devices, select the device where you want to install the SensorApp.
5. If the device tab (lower left pane) contains any active applications, right-click the applications and delete them.

6. To download and install the SensorApp directly from SICK AppPool:
 - a) Click **Login to SICK ID** (below the **Utils** menu in SICK AppManager) to log in to SICK AppPool.
 - b) Click the **AppPool** tab.
 - c) Select the correct SensorApp in the list of available SensorApps.
 - d) Click **Download and install** to download the SensorApp to the computer and install it on the device.

Or:

To install a downloaded SensorApp (.sapk file) from the computer to the device:

- a) Click the **Local Packages** tab in SICK AppManager.
 - b) Drag and drop the SensorApp into the file list.
 - c) Click **Install** to install the SensorApp on the device.
- ✓ The SensorApp is now installed and running on the device.
7. To open the user interface, open a web browser window and type the IP address of the device.

To downgrade the Nova 2D SensorApp:

- To re-use the existing configuration file, export it before the downgrade.
- Keep track of installed plug-ins as they will be deleted when downgrading.
- Delete active applications.
- Downgrade by installing the desired .sapk file and re-import the configuration file.

5.2.1 Installing the .sapk file using SICK AppManager

Install the downloaded .sapk using SICK AppManager. More information about SICK AppManager can be found via SICK Support Portal (supportportal.sick.com).

1. Drag-and-drop the .sapk file from Windows File Explorer to the **Local Packages** section.

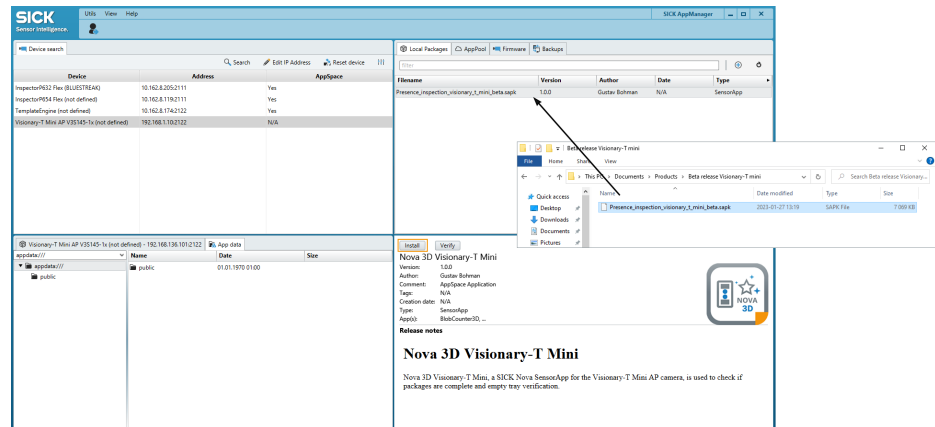

NOTE

If there are files listed in the **App data** tab, delete them prior to commencing the installation.

2. Click **Install** to start the installation.
3. Enter **Userlevel** and **Password**.

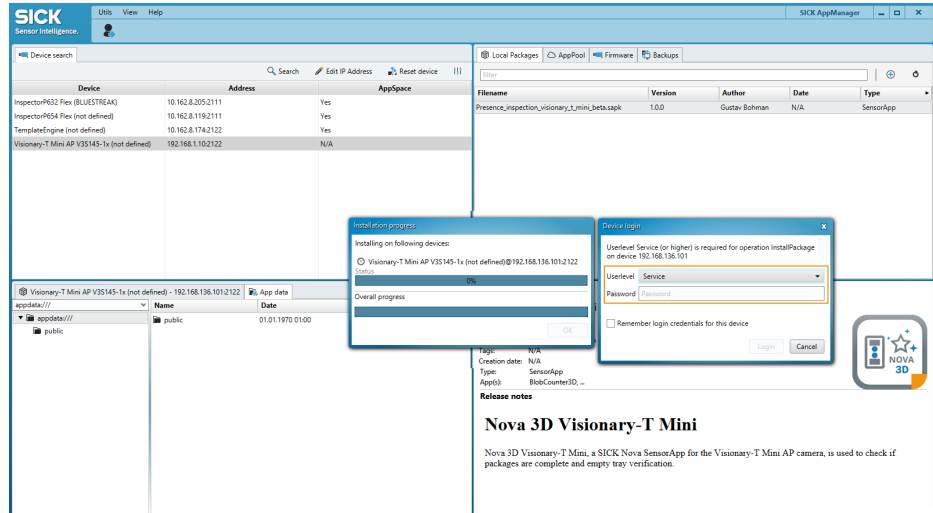

The standard password for **Userlevel: Service**, is `Servicelevel`. However, each package can be built with a different password. If you are installing a beta release, ask the provider for the **Userlevel** and **Password**.

4. Click **Login**.
5. Connect to the device using a web browser. Enter the IP address in the URL-field to load the user interface through SOPASair.
If the SensorApp you installed requires a license, see "[Activating a license using LicenseManager](#)", page 21.

5.3 Activating a license using LicenseManager

Use the LicenseManager to activate a license. When the license is active, the tools included in the license are enabled.

The LicenseManager can be used in two ways:

- Direct license transfer, see "[Direct license transfer](#)", page 22
- File-based license transfer, see "[File-based license transfer](#)", page 24

The direct license transfer requires an internet connection while connected to the device. If no internet connection is available while connected to the device, use the file-based license transfer.

Install LicenseManager

Download LicenseManager from SICK AppPool, <http://appool.cloud.sick.com/>.

1. Drag-and-drop the .sapk file from Explorer to the **Local Packages** section.

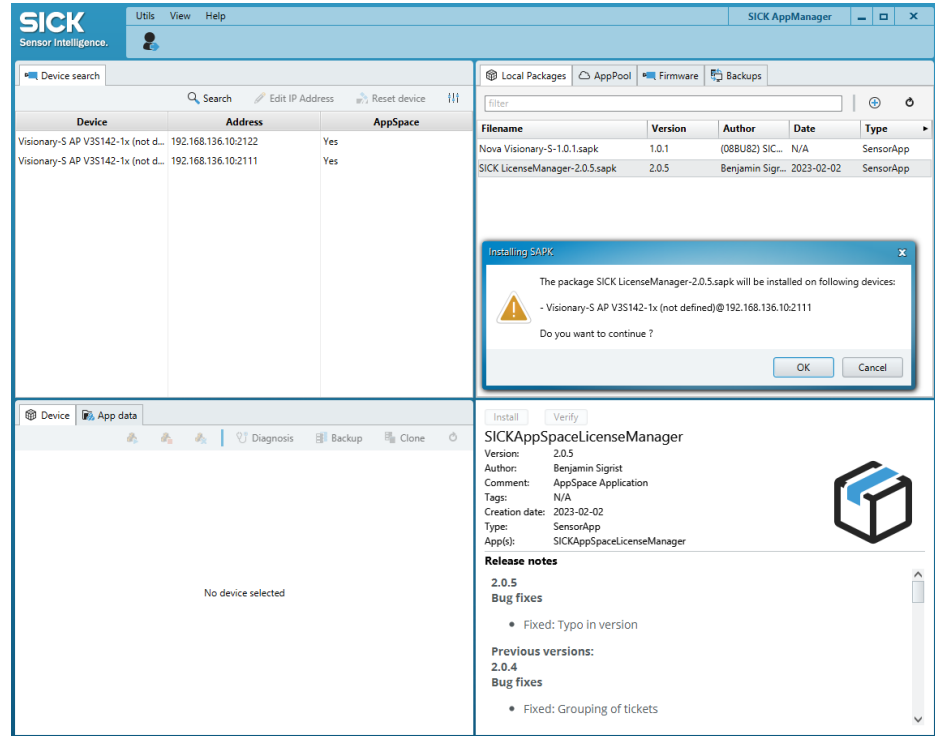

2. Click **OK** to start the installation.

Connect to the device

When the installation is complete, connect to the device by entering the device IP address in a web browser. If there is no valid license active on the device, the LicenseManager will start automatically.

5.3.1 Direct license transfer

If the computer has internet access when connected to the device, the license can be activated directly from the LicenseManager.

1. Select **Yes**, for direct license transfer and click **Next**.

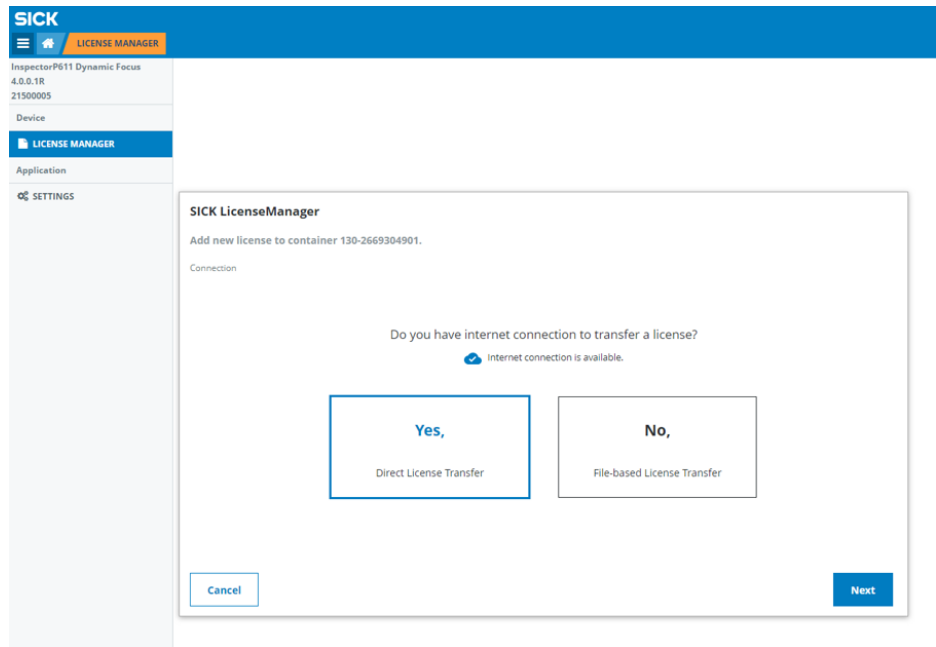

2. Enter the ticket ID you received via e-mail when purchasing the license.

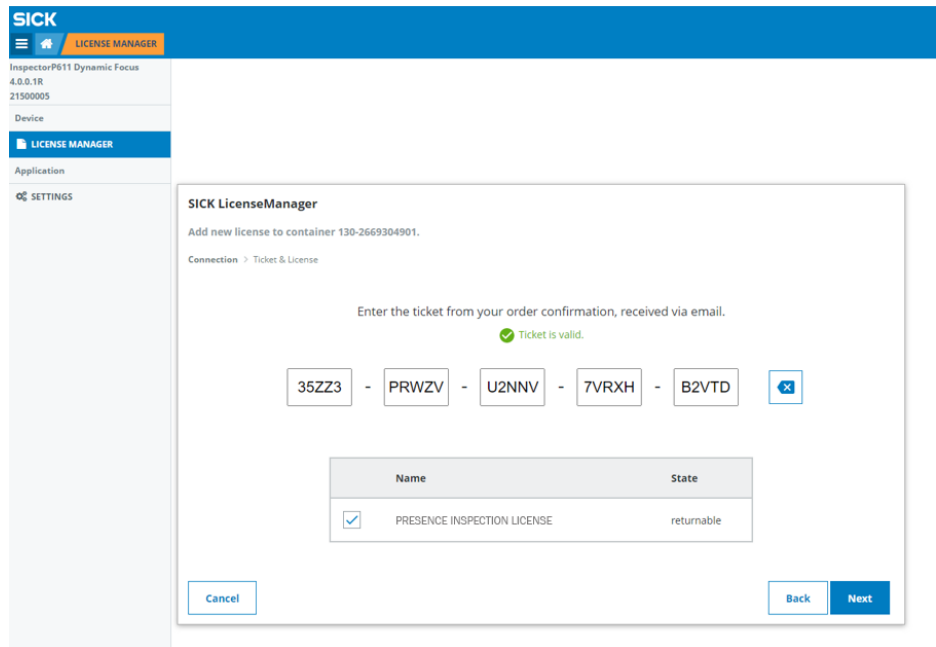

3. Click **Next**, when the checkmark indicates a valid ticket ID.

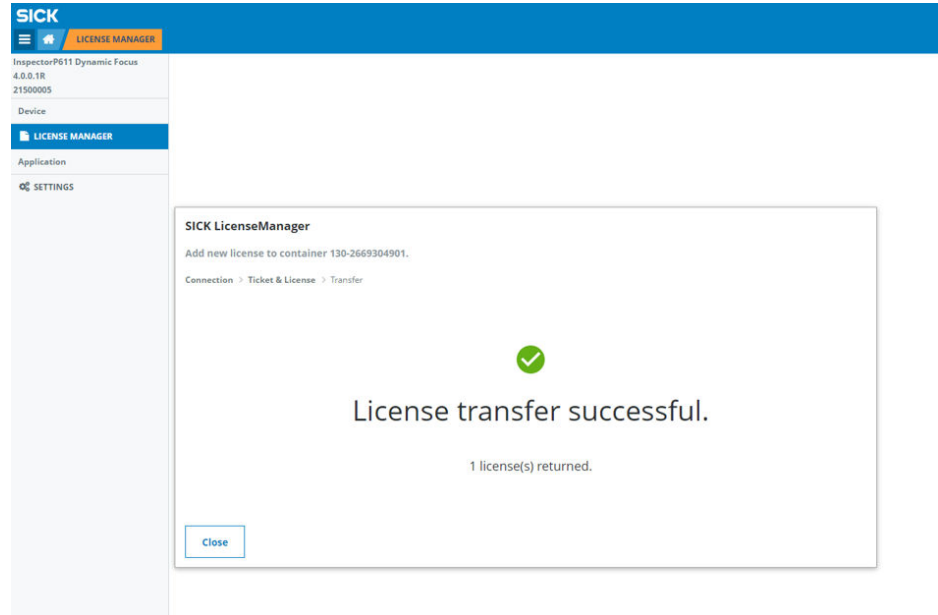

4. **Close** the wizard.
- ✓ The license is now activated on the device.
5. To open the user interface, open a web browser window and type the IP address of the device.

5.3.2 File-based license transfer

If the computer does not have internet access when connected to the device, the license can be activated using the file-based transfer. The LicenseManager will guide you through the installation and activation process on your device.

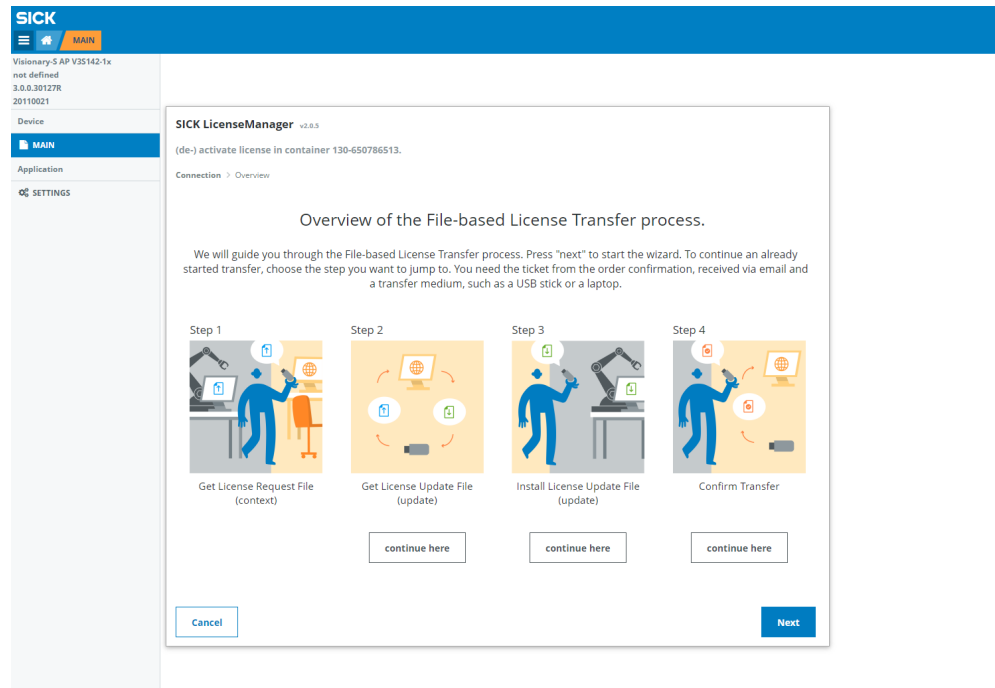



NOTE

The license can also be reused on a different hardware device. To reuse a license, move the license from the device and upload a receipt to the cloud. The license is then possible to use on the new device. This procedure is also handled in the LicenseManager.

1. Click **Save License Request File (context)**. A software license is carried onto the device in a "bucket", which is downloaded from the device to the computer. This bucket file has a filename ending with `.WibuCmRaC`.

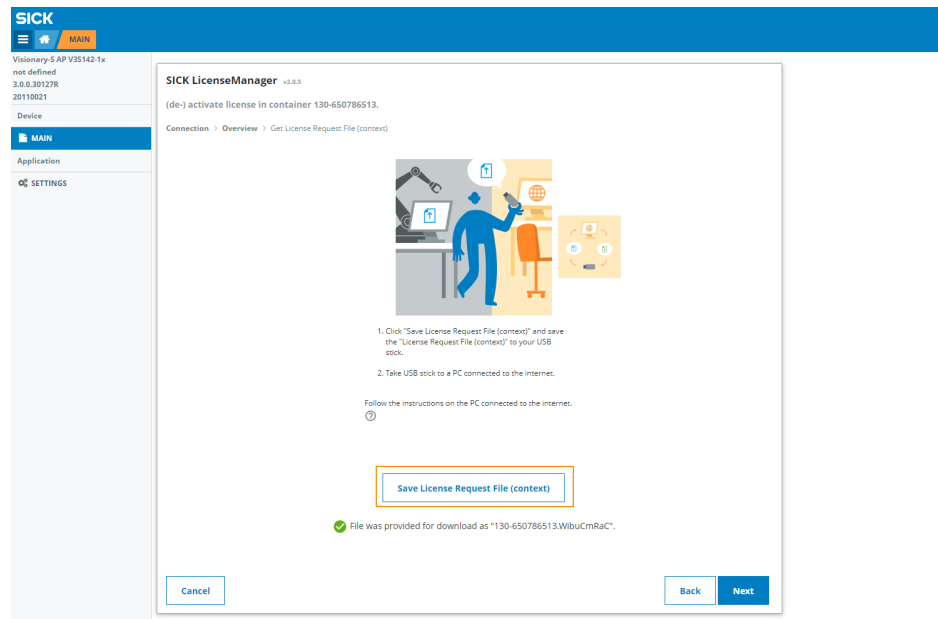

2. Save the license request file in a folder on the computer.

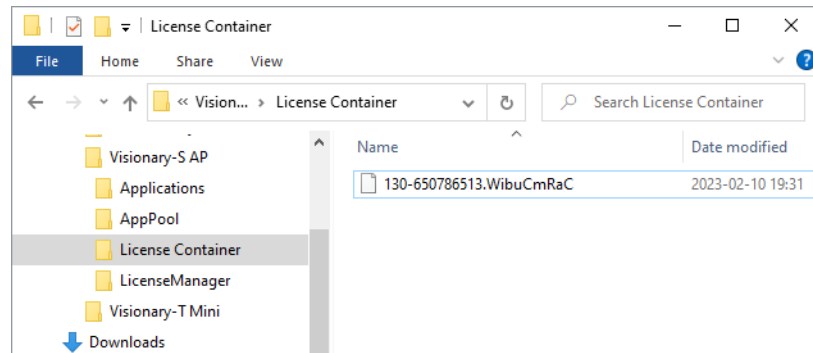

3. Click **Next** when the license request file is downloaded.

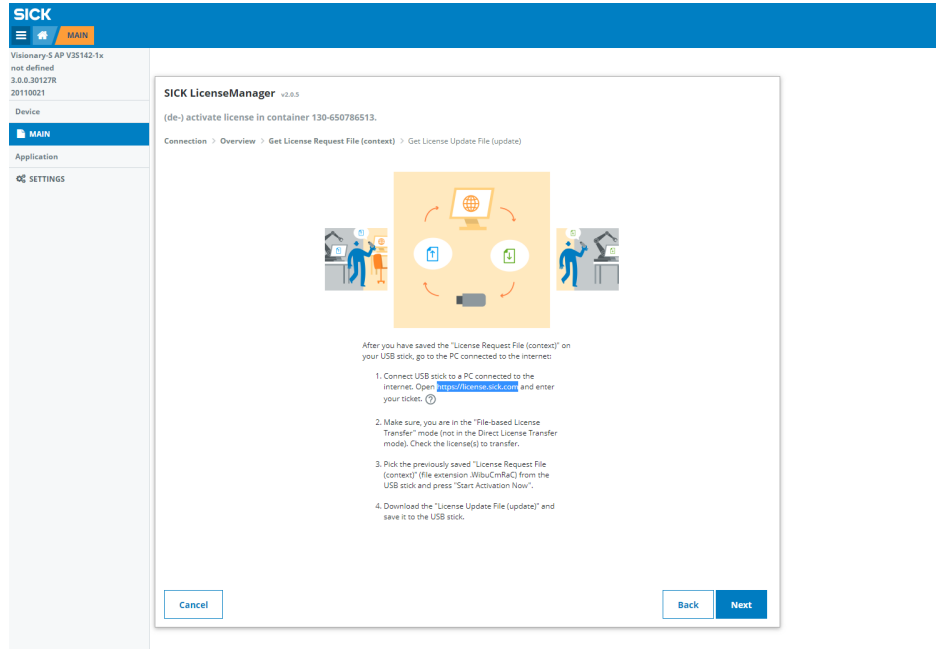

4. Make sure that the computer has internet access. Open a web browser and enter <https://license.sick.com/>.

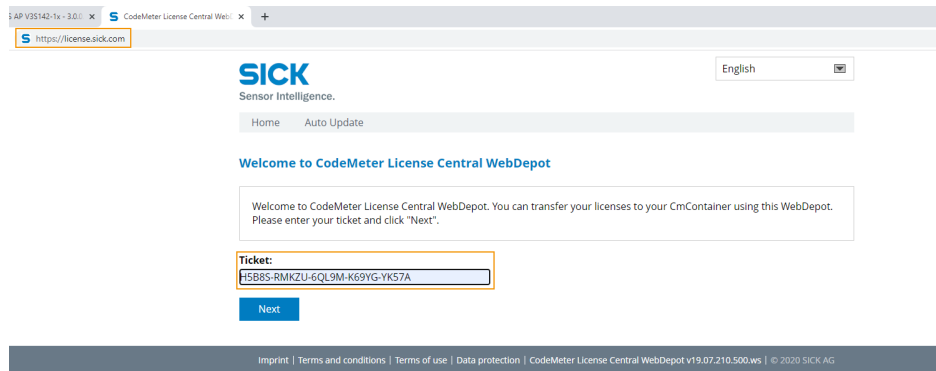

5. Enter the ticket ID purchased from SICK.com or reused from another device.
6. Click **Next** to see available licenses. Click **Continue License Transfer**.
7. Select the license to use. Click **Activate Licenses**.

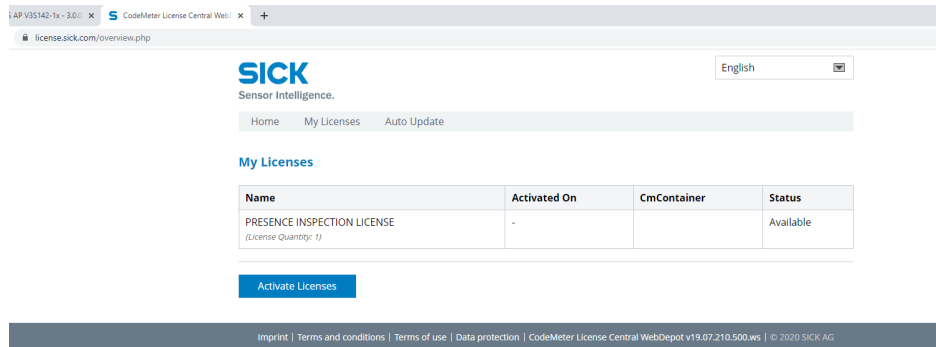

8. The license needs to be connected to the device you want to use it on. Click the **SICK Sensor/SIM** logo.

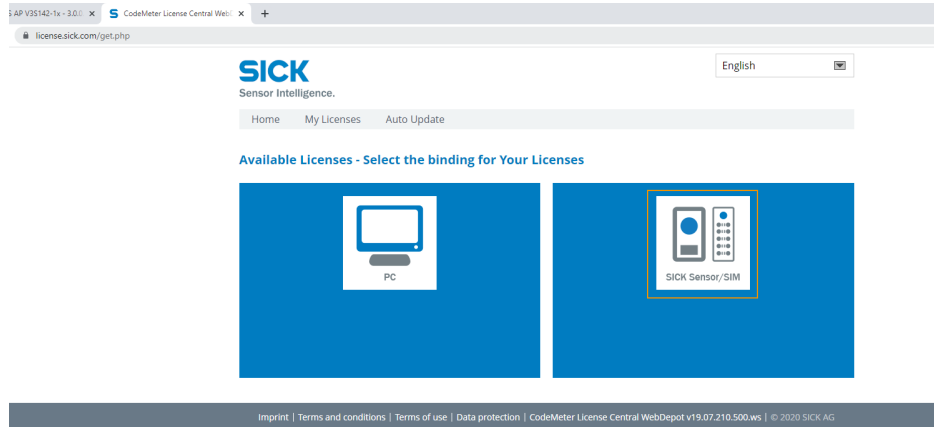

9. Select **Choose File** and point out the previously downloaded bucket file. A second file, similar to the original bucket file, is created. This bucket file has a filename ending with `.WibuCmRaU`. The file can be seen as a filled bucket, holding the license inside.

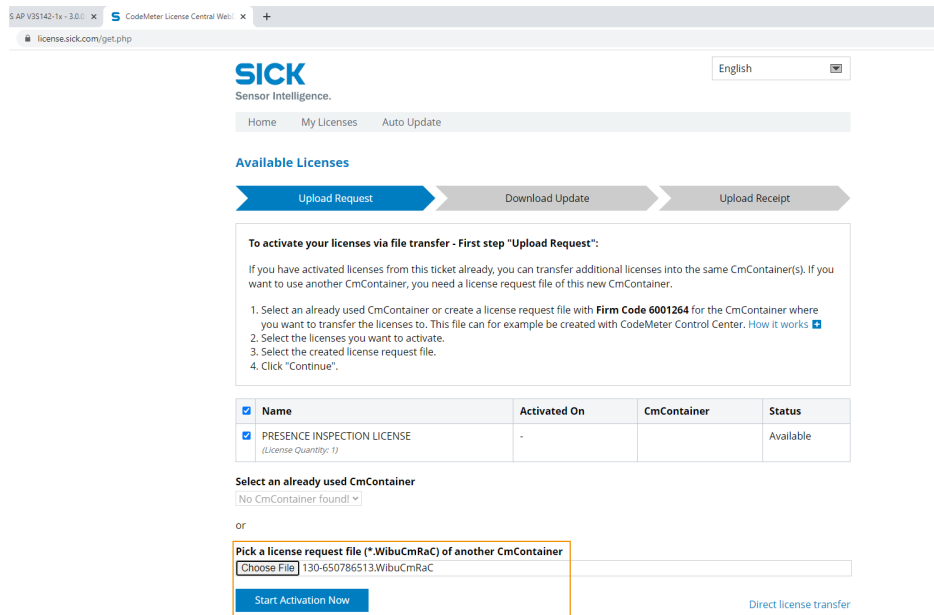

10. Save the file to the same folder as the previous bucket file.
11. Make sure that the device is connected and return to LicenseManager.
12. Click **Choose & install the License Update File (update)** and select the filled bucket file. Click **Open**.

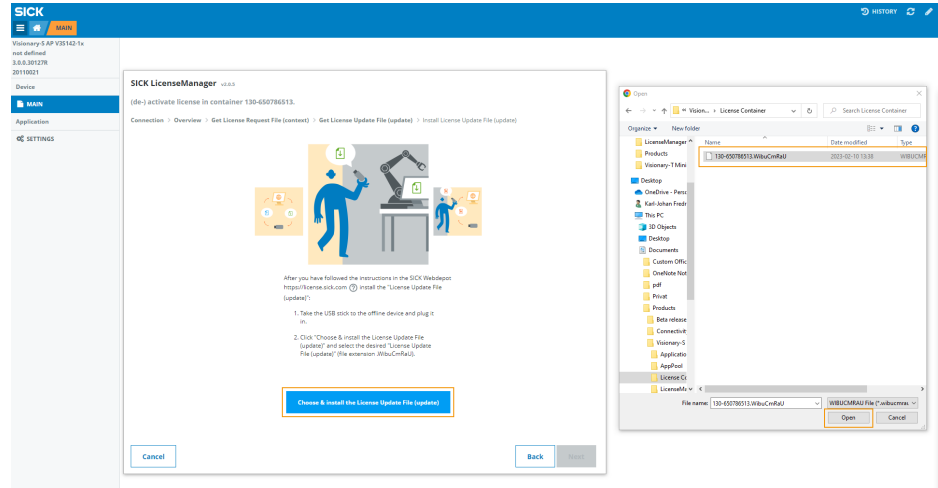

13. The file `.WibuCmRaU` is now installed on the device. Click **Next** to proceed with the final steps.

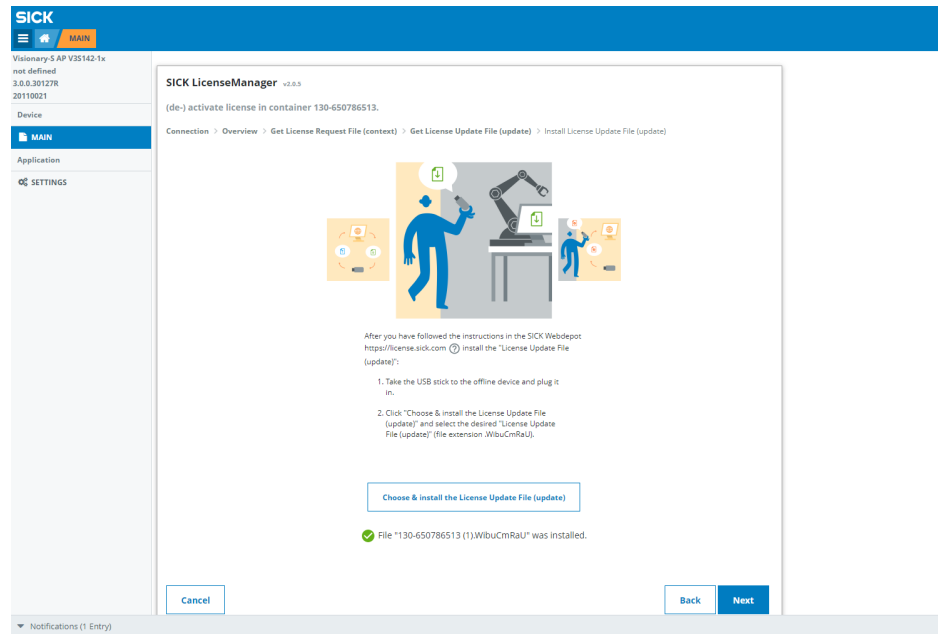

14. Upload a receipt file to SICK License Server to finalize the license activation. Click **Save Receipt File** and save the receipt to a new bucket-file. Place the file in the same folder as the previous bucket files.

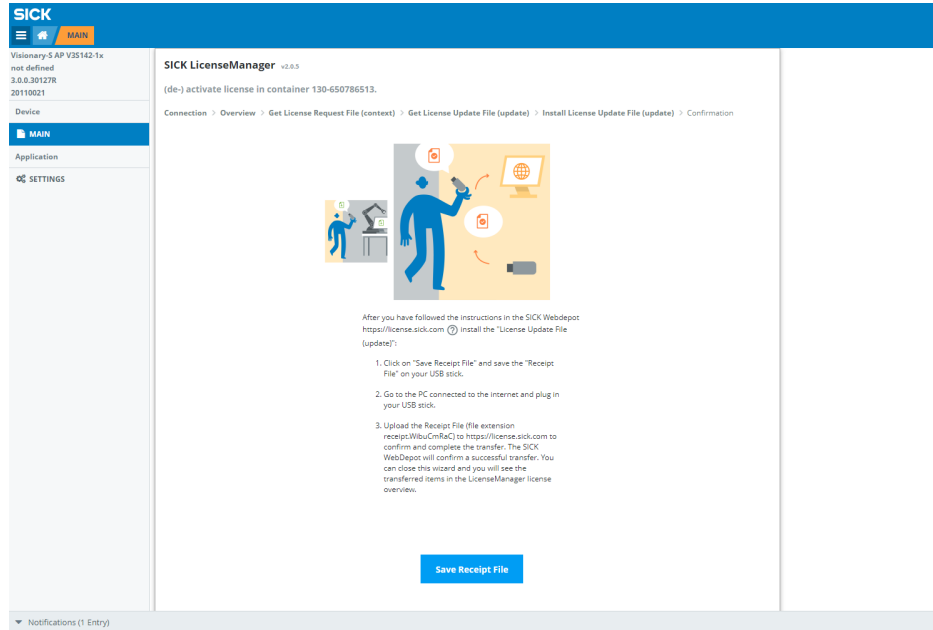

15. Make sure that the computer has internet access. Open a web browser and enter <https://license.sick.com/>.
16. Select **Choose File** and point out the bucket-file with the receipt, to confirm the license transfer. Click **Upload Receipt Now** to complete the license process.

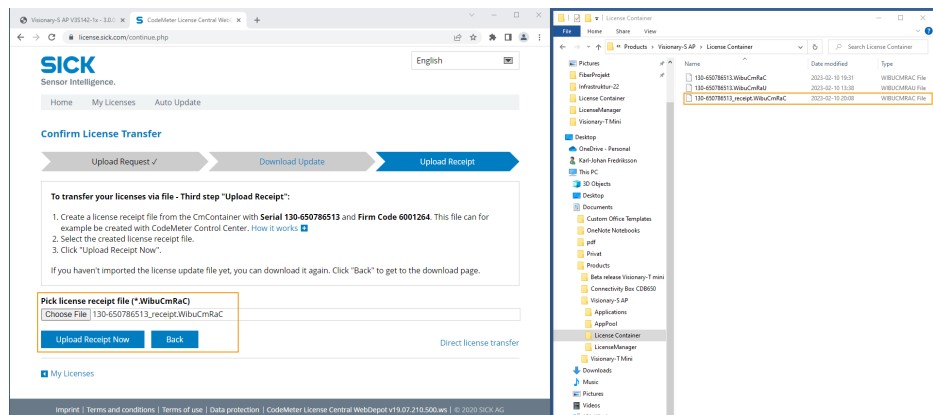

- ✓ The license is now activated on the device.
17. To open the user interface, make sure that the computer and device are connected. Open a web browser window and type the IP address of the device.

5.4 SICK AppManager

A computer running the SICK AppManager software is required for the following actions:

- Installing and updating a SensorApp on a device.
- Starting, stopping, and deleting installed SensorApps.
- Reading and changing the device's IP address.
- Installing firmware updates.

Download SICK AppManager from www.sick.com/SICK_AppManager.

5.5 SICK AppEngine

The SICK AppEngine computer software is supported to run as an emulator and is downloaded via login on www.sick.com/SICK_AppSpace.

SICK AppEngine can be used for non-production environments, off-line configuration, or testing purposes.

Install SICK AppEngine

1. Download the SICK AppEngine installer file.
2. Follow the steps in the installer dialog.
3. Open SICK AppEngine, which will automatically start running in demo mode.

A complete installation guide and download can be found via SICK Support Portal (supportportal.sick.com).



NOTE

SICK AppEngine will run for 120 minutes in a demo mode with full functionality and will shut down afterward automatically. The demo mode can be used without applying a license.

Start SICK AppManager and use the SICK AppEngine emulator to run Nova 2D.

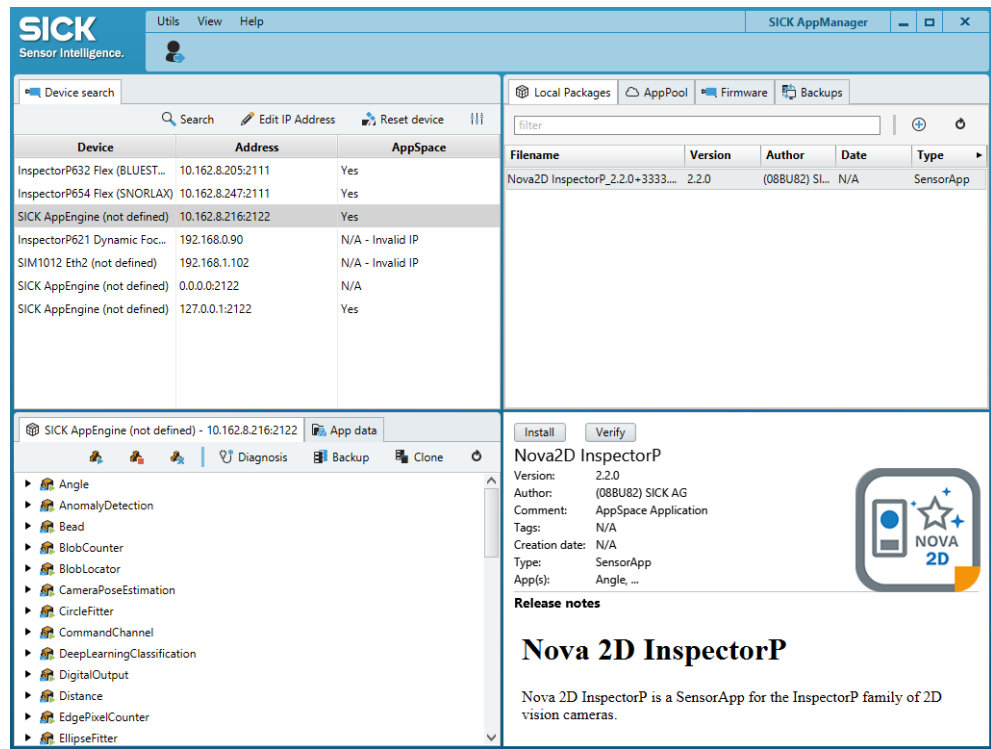

More information about SICK AppManager can be found via SICK Support Portal (supportportal.sick.com).

5.6 Installing tools

In addition to the tools that are included in the SensorApp by default, custom tools can be installed and integrated in the SensorApp. Tools are installed as .sapk files using SICK AppManager. Each file may contain one or more tools.



NOTE

The use of additional tools requires that both the SensorApp and the tool are present on the device.

Follow the steps below to install tools using SICK AppManager. The device must be connected to the computer via Ethernet.

1. In the SensorApp web user interface, click **Save Permanently** to avoid losing any data during the tool installation process.
 2. On the computer, open SICK AppManager and click **Scan** to browse for available devices.
 3. In the list of available devices, select the device where the SensorApp is installed.
 4. To download and install a tool directly from SICK AppPool:
 - a) Click **Login to SICK ID** (below the **Utils** menu in SICK AppManager) to log in to SICK AppPool.
 - b) Click the **AppPool** tab.
 - c) Select the correct tool in the list of available toolsets.
 - d) Click **Download and install** to download the tool to the computer and install it on the device.
- Or:
- To install a downloaded tool (.sapk file) from the computer to the device:
- a) Click the **Local Packages** tab in SICK AppManager.
 - b) Drag and drop the tool into the file list.
 - c) Click **Install** to install the tool on the device.
- ✓ The tool is now installed and running on the device.
5. When the tool installation is complete, reload the web browser to view the installed tool in the user interface.

6 Operation

6.1 User interface

Opening the user interface

1. Open a web browser window.
2. Type the IP address of the device. The default IP address is 192.168.0.1.



NOTE

If you do not remember the device IP address, SICK AppManager will help you find it.

Overview of the user interface



Figure 5: User interface overview

- ① Tool categories with tool boxes and tool tree
- ② Job list
- ③ System/Jobs switch
- ④ Image source selection
- ⑤ Image viewer
- ⑥ Header information
- ⑦ Licensed toolset
- ⑧ Mode selection (Run/Configure)
- ⑨ Overall result, cycle time and issues list
- ⑩ Login and logout options
- ⑪ Save permanent
- ⑫ Import and export options, file explorer, language selection
- ⑬ Tool pane
- ⑭ Tool help
- ⑮ Footer information
- ⑯ Image controls

The footer shows information about the current setup, such as:

- Which toolset is active, i.e. Presence Inspection, Quality Inspection, or Intelligent Inspection.
- The connected device.
- The current **User level**.

6.1.1 Top menu items

The top menu in Nova applies actions to the entire software. You can, for example, select which language you want to use in the software.

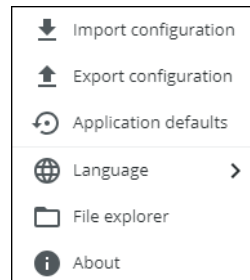

Figure 6: Nova top menu selection.

For information about how to handle configurations, see ["Configure mode"](#), page 46.

6.1.1.1 Reset to application defaults

Resetting the Nova configuration to the default settings also gives the possibility to reset permission settings. The option **Application configuration** is mandatory.

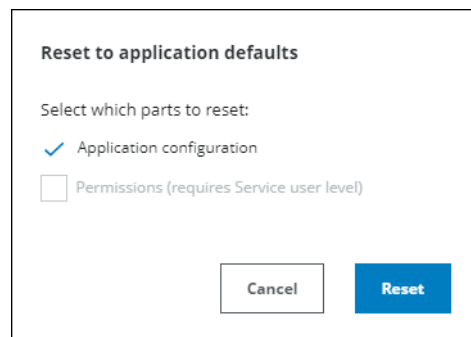

Figure 7: Reset to defaults dialog

Resetting to application defaults will:

- Remove all jobs. An empty job is created.
- Keep the device IP address.
- Keep system settings for **Fieldbus**.



NOTE

Permissions can only be selected if the user is logged on as service user level.

6.1.1.2 File explorer

The file explorer provides easy access to images stored on the device.

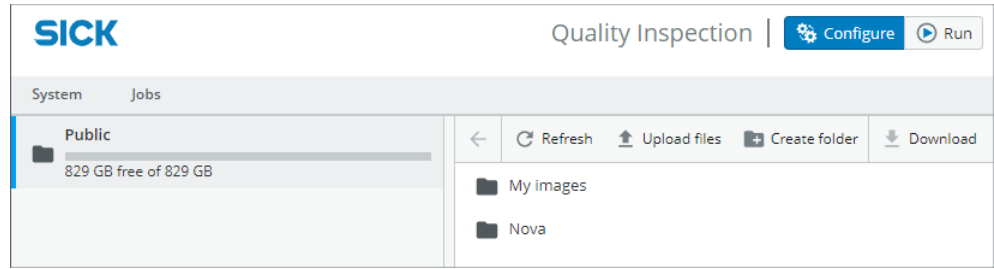

Figure 8: File explorer

6.1.2 Tool tree

The toolset concept is based on a tool tree structure, which contains defined categories and associated tools. A configuration contains one tool tree for the system level and an additional tool tree for each created job.

The user adapts each tool tree to the application of interest by adding tool instances to the different categories. The available tools for each category are described in detail in "System settings", page 48 and "Job settings", page 57.

An example of a job tool tree is displayed in figure 9.

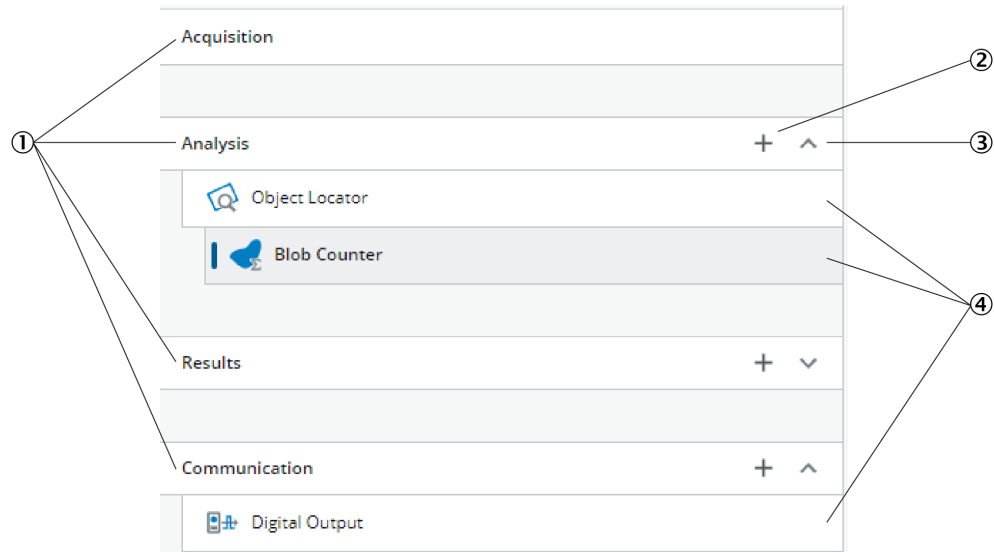

Figure 9: Example of a job tool tree with added tool instances

- ① Categories
- ② Open tool box
- ③ Show or hide tool tree
- ④ Added tool instances

Adding and removing tool instances

To add a tool instance to a tool tree:

1. Click the plus sign for a category in the tool tree to display its associated tools.

2. Create a new instance of the tool, using one of the following options:
 - a) Click a tool icon to create a new instance of the tool to the selected category or linked to the selected tool.
 - b) Click and drag a tool icon to the correct category or linked to the correct tool in the tool tree to create a new instance of the tool. Possible and correct drops are indicated with gray underline. Selected drop is indicated with green highlight.

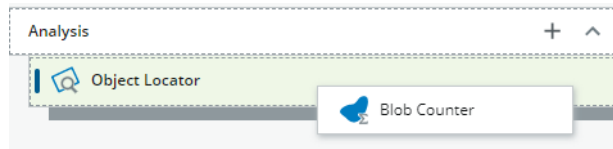

To remove a tool instance from a tool tree:

1. Hover the mouse over the tool and click the trash bin to delete.

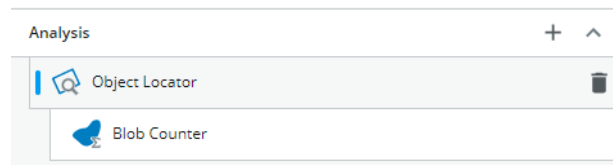

2. In the dialog box that appears, click **Delete** to confirm deletion.



NOTE

Deleting a parent tool will also remove all of its child tools.

Editing the tool settings

Click a tool instance in the tool tree to display its tool pane, which contains all the available settings and result parameters. For more information about the settings and result parameters, click the tool help (Help button) in the tool pane.

6.1.3 Monitoring results and cycle times

Click the overall result in the header information to view the results in detail. The view shows a result history that is populated when the application is in **Run** mode.

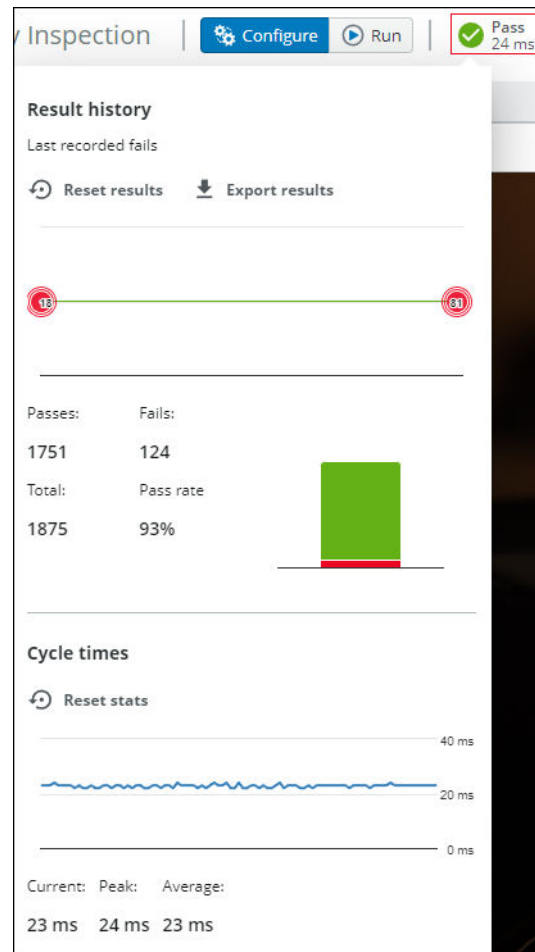

Figure 10: The results history in detail.

Result history

The result graph displays the latest overall result failures that have been recorded. The graph only shows the latest 100 fails. Fails that happened close together in time, are clustered in the graph.

The pass/fail graph shows the ratio between overall result passes and failures. The green bar represents the amount of passes. The red bar represents the amount of fails.

Use the button **Reset results** to clear the result history. Use the button **Export results** to download a file with all information about the latest recording fails and overarching statistics.

Cycle times

The cycle times graph shows the latest recorded cycle times. Below the graph the current, peak and average cycle times are shown.

Use the button **Reset stats** to clear all cycle time statistics.

6.1.4 Monitoring CPU and memory usage

Click the IP address in the footer information to view the CPU and memory usage in detail.

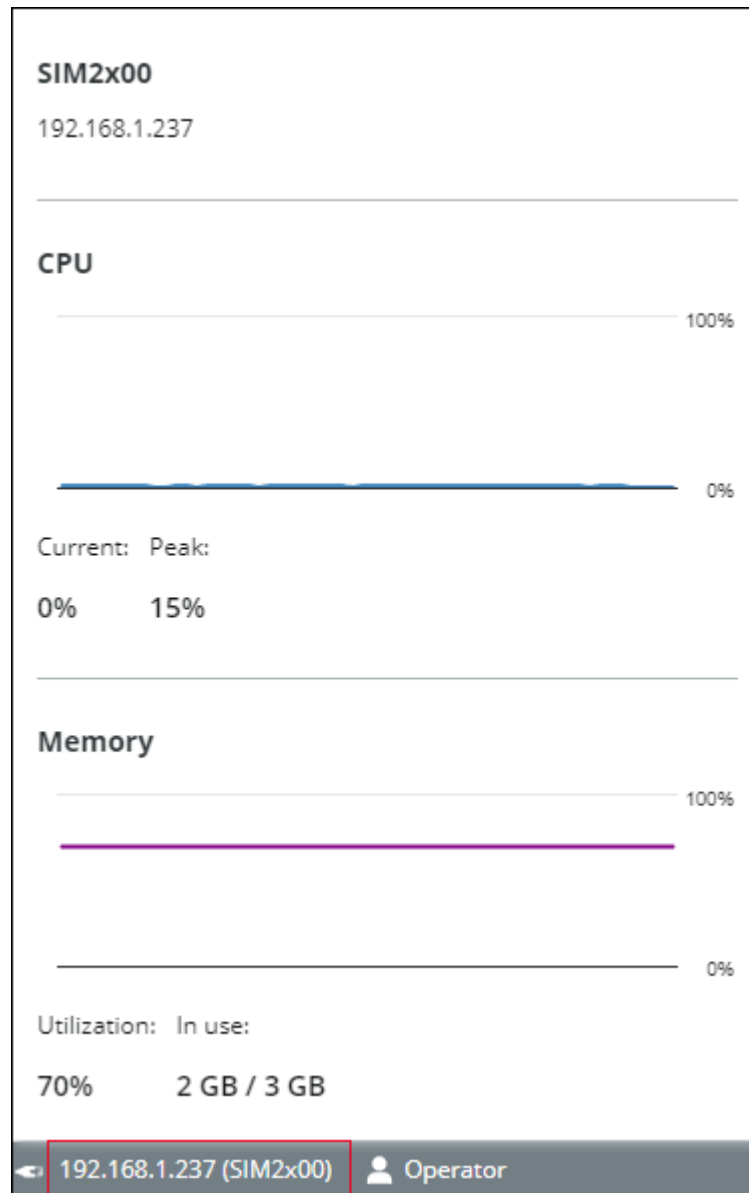

Figure 11: The usage information in detail.

6.1.5 Image source

Use the image source selection buttons on the **Jobs** page to select an image source for the configuration. Each option has a set of associated controls, which are displayed below the image viewer.



NOTE

The selected image source is only used during the configuration. In **Run** mode, the analysis is based on live images.

Live image



Set up the configuration based on live images. The **Live** option is suitable for configuring in the real inspection environment.

**NOTE**

- The Live option is not available when using the SICK AppStudio Emulator or SICK AppEngine.

Table 1: Controls available for live images

Control	Name	Function
	Free running	Acquire images continuously.
	Run as configured	Acquire images based on the current configuration settings.
	Stop	Stop the image acquisition.
	Trigger	Acquire one single image (trigger an image acquisition by clicking the button).
	Download current image	Export the displayed image to a local file on the computer. The saved images are in a format that can be used with playback. The images do not contain result overlays and they are unaffected by image view zoom.
	Update reference	Set the currently displayed image as the reference image. The currently stored reference image is overwritten.

Playback image

Set up the configuration based on recorded images stored on the device, or images stored on computer when using SICK AppEngine as emulator.

Table 2: Controls for playback images

Control	Name	Function
	Play	Display and loop through the images in the target folder.
	Pause	Pause the playback.
	First image	Go to the first image in the series.
	Next image	Step to the next image in the series.
	Download current image	Export the displayed image to a local file on the computer. The saved images are in a format that can be used with playback. The images do not contain result overlays and they are unaffected by image view zoom.
	Settings	<p>Cycle images (On/Off)</p> <p>Image folder: The folder where the recorded images are stored. The folder must be a public folder on the device or a folder on an SD card. Examples:</p> <pre>/public/myDirectory</pre> <pre>/sdcard/0/myDirectory</pre> <p>If using SICK AppEngine as emulator, specify a folder where your images are stored. Example:</p> <pre>C:\myDirectory</pre>

Control	Name	Function
	Update reference	Set the currently displayed image as the reference image. The currently stored reference image is overwritten.



Reference image



Set up the configuration based on a saved reference image. This option is suitable if there is one particular image that you want to use for the configuration.

- The reference image is job-specific and must be defined for each job.
- To save a reference image, click **Update reference** (available for the **Live** and **Playback** options).
- A reference image is required for setting the region of interest for the **Object Locator** tool.

Table 3: Controls for the reference image

Control	Name	Function
	Reset view	Reset the image view.
	Open in fullscreen	Open the image viewer in fullscreen mode.
	Exit fullscreen	Exit fullscreen mode and return to image viewer.

6.1.6 Creating and switching jobs

Create a job for each inspection situation and object type. The job list in the upper left part of the user interface displays the active job.



If there is no configuration saved on the device when opening the SensorApp, a new job ('Job 1') is created automatically.



- ① Job list
- ② New job
- ③ Job options

Adding and removing jobs

Use the buttons next to the job list to add and edit jobs to and from a configuration. The **Job options** button will open up the possibility to clone and remove the currently selected job.

Icon	Name	Description
	Rename job	Rename the currently selected job.
	Clone job	Create a copy of the currently selected job and add to the configuration.
	Detete job	Remove the currently selected job from the configuration.



NOTE

Give the job a name describing what the application does, to make it easier to find the correct job for a task.

Selecting jobs

Click the job list to display and switch between existing jobs.

When the device is restarted, the most recent active job is reactivated (Requirement: **Save permanently** has been done prior to the restart, see "[Saving, importing and exporting a configuration](#)", page 47).

6.2 Permissions and user level access

Using the **Permissions** settings it is possible to manage access to the application. Configure the user levels and their respective permissions.

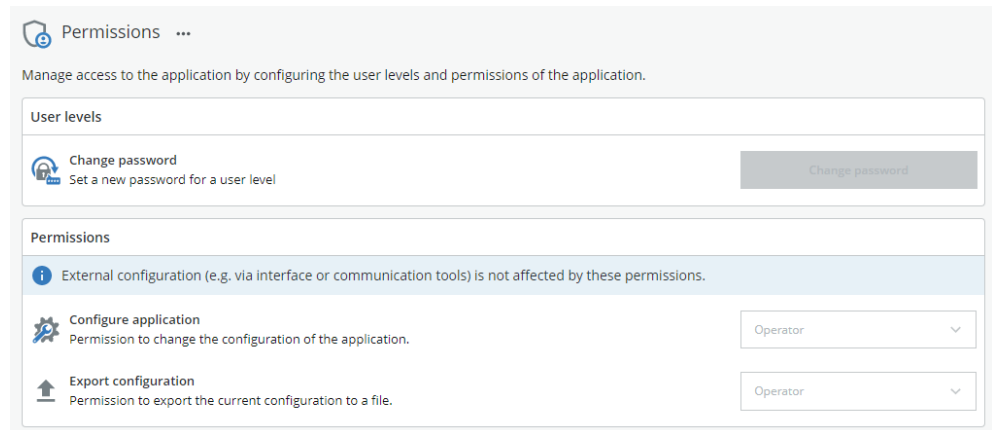

Figure 12: Define access permissions for user levels



NOTE

By default all permissions are set to **Operator**, so no login is required. Only exception is managing permissions, which only **Service** level has access to.

Possible permissions:

- **Configure application:** Gives the user level permission to change the configuration of the application.
- **Export configuration:** Gives the user level permission to export the current configuration to a file.

Available user levels:



- **Operator:** Not logged in.
- **Authorized client:** Default password (InspectorP6xx devices) is `client`.
- **Service:** Default password (InspectorP6xx devices) is `servicelevel`.

The user levels are hierarchical. The permissions granted for the **Authorized client**, will automatically be granted for **Service**.

6.2.1 Logging in

If the user is not logged in, the user access level is **Operator**.

Option		Function
	Login	Log in to the application at a selected user level. The button is located in the header.

Option		Function
	Logout	Log out from the application. When logging out, the user level is automatically returned to Operator . The button is located in the header.
	Operator	Change user level by clicking the button in the footer displaying the current user level.

Select the **User level** and enter the **Password**.

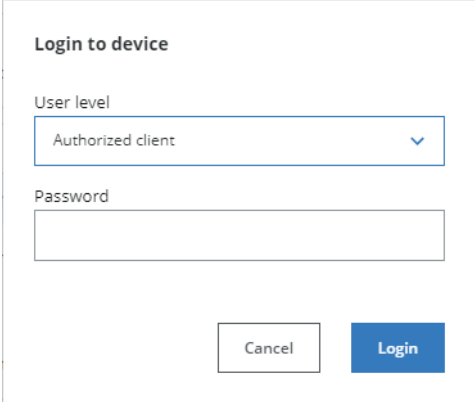

Login to device

User level

Password

Figure 13: Login dialog

6.2.2 Change password

The user can change password for the different user levels. Click the button **Change password** to open the dialog.

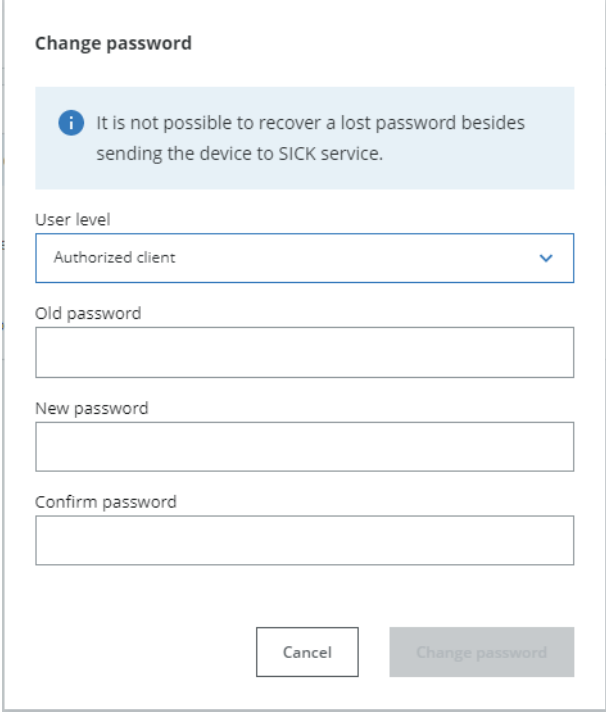

Change password

 It is not possible to recover a lost password besides sending the device to SICK service.

User level

Old password

New password

Confirm password

Figure 14: Change password for a user level



NOTE

It is not possible to reset a password. If the password is forgotten, the device must be sent to SICK for servicing.

1. Select the **User level** for which you want to change the password.
2. Enter the **Old password**.
3. Enter the **New password**.
4. Enter the new password in **Confirm password**.
5. To confirm the change, click the button **Change password**.

6.3 Editing the image acquisition settings

To edit the image acquisition settings for a job, click the **Acquisition** category. The **Acquisition** settings are displayed in the tool pane to the right of the image viewer.



NOTE

Changes to the image acquisition settings are applied to the next acquired image.

6.3.1 Working with an Inspector device

Auto setup

The **Auto setup** feature in **Acquisition** aids the user to get a good image straight away. When pressing the button **Run auto setup**, alternative configurations are displayed. The user can select which parameters to include when running the **Auto setup**.

Setting	Description
Use region of interest	The Auto setup is performed within the defined region of interest. <ul style="list-style-type: none"> • Green region: the auto setup has been performed for that region. • Red region: auto setup has not been performed for that region.
Auto exposure	The Auto setup adjusts the Exposure time when performing the setup.
Auto focus	The Auto setup adjusts the Focus when performing the setup. This option is only available for devices with dynamic focus.
Auto contrast	The Auto setup adjusts the Contrast when performing the setup.

Settings

Setting	Description
Exposure time	The exposure time of the sensor. Increase the exposure time to get a brighter image. Some device types have a lower limit on the maximum exposure time when integrated lighting is enabled. The exposure time will be limited automatically due to eye safety concerns and a warning will display the maximum value when it is exceeded.
Brightness	The brightness (gain factor) for image acquisition. Keep the brightness low to reduce the level of noise. If a brighter image is required, it is recommended to increase the exposure time before increasing the brightness.
Contrast	The contrast level for image acquisition. Increase the contrast to make objects in the image more distinguishable.
Downsample	The downsample factor for the acquired images. The downsample factor is applied both vertically and horizontally. For example, a downsample factor of 2 will resize a 1000 x 1000 px image into a 500 x 500 px image. Downsampling is recommended to save disk space and to decrease the processing time for images with high resolution.
Horizontal FOV	Limit the camera's field of view width (X direction). At least 20% of the total width must be used.

Setting	Description
Vertical FOV	Limit the camera's field of view height (Y direction). At least 20% of the total height must be used.
Integrated lighting	Use the integrated light in the device during the image acquisition. This option is only available for devices that support external lighting. If an external light is connected to the device, the integrated and the external lighting can be used in parallel.
Aiming light	Enables or disables the aiming light. The aiming light is automatically turned off during an image acquisition and then turned on again, if enabled.
External light type	<p>Define the type of external light that is connected to the device:</p> <ul style="list-style-type: none"> For light sources sold by SICK (denoted by ICL), select the correct model in the list to automatically configure the required device settings. For other light sources, select the Active high (flashing) or Active low (flashing) setting, depending on whether the light source triggers on an active high (+5 V) or active low (+0 V) signal. See the light source specification for details. <p>The External light type option is only available when the device is configured for use with external lighting. To configure the device for use with external lighting, use the I/O Configuration tool.</p>
Focus	<p>The focus distance (in mm) for devices with dynamic focus. The lower and upper limits are set based on the possible focus distances for the device.</p> <p>This option is only available for devices with dynamic focus.</p>
External trigger	Enable the use of an external trigger, e.g. a photoelectric sensor or a trigger command through the Command Channel , to trigger image acquisition. If a digital input is used, the external trigger must be connected to digital input port 1. The image acquisition starts on a rising edge signal.
Delay	<p>The delay between the trigger signal and the image acquisition when using an external trigger.</p> <p>This option is only available when an External trigger is selected.</p>
Record images	Record and save all acquired images to a specified target folder. Images are only recorded when the system is in Configure mode and Live images are used as the image source.
Record directory	<p>The full path to the target folder where the recorded images are saved. The target folder must be a public folder on the device or a folder on an SD card. Examples:</p> <pre>/public/myDirectory /sdcard/0/myDirectory /ram</pre> <p>The <code>/ram</code> location is not persistent.</p> <p>If the selected target folder is not valid, an error message appears in the log.</p>
Image correction	<p>Apply a calibration model to all acquired images. This option is only available when a calibration model has been created by the Camera Pose Estimation tool.</p> <p>Correction options:</p> <ul style="list-style-type: none"> No correction: Do not apply the calibration. Lens distortion: Remove lens distortion from the acquired images. Full calibration: Remove lens distortion and perspective from the acquired images, apply a world coordinate system with unit 'millimeters' to each image.

6.3.2 Working with a picoCam2 or midiCam2

The **Acquisition** category contains settings for image acquisition and image quality. Changes to the image acquisition settings are applied to the next acquired image.

To be able to acquire images and changing settings, first select an external camera in the tool **Camera Connection**, see "[Camera Connection tool](#)", page 48.

When a camera is selected, information and connection status of the camera is shown in the tool pane.

Settings

Setting	Description
Exposure time	The exposure time of the sensor. Increase the exposure time to get a brighter image.
Brightness	The brightness (gain factor) for image acquisition. Keep the brightness low to reduce the level of noise. If a brighter image is required, it is recommended to increase the exposure time before increasing the brightness.
Contrast	The contrast level for image acquisition. Increase the contrast to make objects in the image more distinguishable.
Downsample	The downsample factor for the acquired images. The downsample factor is applied both vertically and horizontally. For example, a downsample factor of 2 will resize a 1000 x 1000-pixel image into a 500 x 500-pixel image. Downsampling is recommended to save disk space and to decrease the processing time for images with high resolution.
Horizontal FOV	Limit the camera's field of view width (X direction).
Vertical FOV	Limit the camera's field of view height (Y direction).
Image correction	Apply a calibration model to all acquired images. This option is only available when a calibration model has been created by the tool Camera Pose Estimation . Correction options: <ul style="list-style-type: none"> • No correction: Do not apply the calibration. • Lens distortion: Remove lens distortion from the acquired images. • Full calibration: Remove lens distortion and perspective from the acquired images, apply a world coordinate system with unit millimeters to each image.

Triggering

Setting	Description
External trigger	Enable the use of an external trigger, e.g. a photoelectric sensor or a trigger command through the Command Channel , to trigger image acquisition. If a digital input is used, the external trigger must be connected to digital input pin 2 or 4 on the S2 connector. The image acquisition starts on a rising edge signal. Enable power for the S2 connector in the tool Power Configuration , if the SIM2x00 is triggered by a sensor without an external power source.
Delay	The delay between the trigger signal and the image acquisition when using an external trigger. This option is only available when an External trigger on the S2 connector is selected.

Setting	Description
Camera trigger	<p>Define how the SIM triggers the external camera.</p> <p>To get high precision and low jitter, it is recommended to power the camera using the S1 connector.</p> <p>Use the Ethernet option if the camera is not connected to the S1 connector, i.e. if powered using Power over Ethernet (PoE) or using an external power source.</p> <p>Enable power for the selected connector in the tool Power Configuration.</p>

For more information about configuring the power settings, see "[Power Configuration tool](#)", page 55.

Lighting

Setting	Description
External light type	<p>Define the type of external light that is connected to the device:</p> <ul style="list-style-type: none"> Select the S3 (active high) or S3 (active low) setting, depending on whether the light source triggers on an active high or active low signal. See the light source specification for details.



NOTE

The external light must be connected to the S3 connector and the camera must be connected and powered via the S1 connector.

Image recording

Setting	Description
Record images	Record and save all acquired images to a specified target folder. Images are only recorded when the system is in Configure mode and Live images are used as the image source.
Record directory	<p>The full path to the target folder where the recorded images are saved. The target folder must be a public folder on the device or a folder on an SD card. Examples:</p> <pre>/public/myDirectory /sdcard/0/myDirectory /ram</pre> <p>The <code>/ram</code> location is not persistent.</p> <p>If the selected target folder is not valid, an error message appears in the log.</p>

6.4 Setting the region of interest for a tool

Some tools in the **Analysis** category operate within a defined region of interest (ROI). For such tools, the tool pane contains a **Regions** list where the ROI can be set.

Adding regions for a tool instance

When a tool instance is added to the tool tree, it is automatically assigned a rectangular default region which is displayed in the **Regions** list. To add additional regions, click **Add region**.

Because at least one region is required for each tool, the **Delete** button is only enabled if the **Regions** list contains more than one item.

Positive and negative regions



NOTE

If the total ROI is negative, the tool is invalid and gives a **Fail** result.

Each region in the **Regions** list is defined as positive or negative. The total ROI for a tool is defined as the union of all the positive regions subtracted by the union of all the negative regions, according to [figure 15](#).

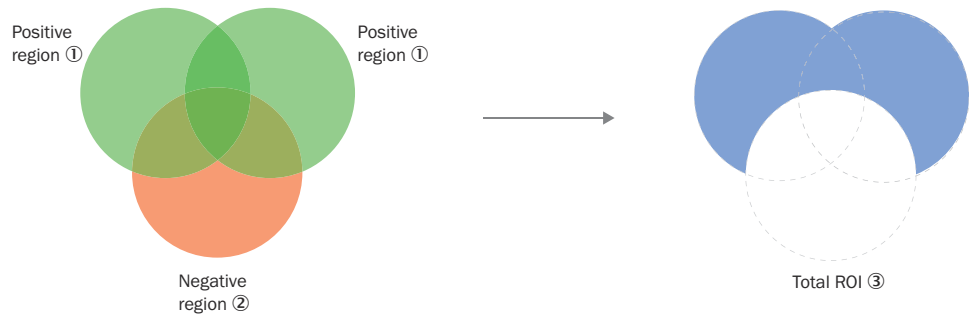

Figure 15: Positive and negative regions and the total ROI

- ① Positive region
- ② Negative region
- ③ Total ROI

Editing the ROI

To change the size and position of a region:

- Hover over a region in the image viewer to highlight its handles.
- Click and drag the center handle to move a region.
- Click and drag the side or corner handles to resize a region.

Visualization of results

By default, the ROI for each tool instance is displayed as an overlay in the image viewer. The ROI for the active tool is displayed with a yellow transparent overlay. The ROI border-color corresponds to the tool result (green color for **Pass**, red color for **Fail**).

To hide the overlay for a tool instance, clear the **Show regions and overlays** checkbox in the tool pane.

6.5 Configure mode

Use **Configure** mode to set up a configuration for the application of interest.



NOTICE

Click **Save permanent** in the configuration toolbar to save a configuration to the device's flash memory. If a configuration is not saved before disconnecting the power to the device, all settings are lost.



NOTE

All communication interfaces are inactive in **Configure** mode, except for **Command Channel** replies.

Follow the steps below to set up a configuration:

1. Add tools to the **System** tool tree and edit the tool settings, see "[System settings](#)", [page 48](#).
2. Select an image source for the configuration, see "[Image source](#)", [page 37](#).
3. Select a job, see "[Creating and switching jobs](#)", [page 39](#).
4. Add tools to the job tool tree and adjust the tool settings, see "[Job settings](#)", [page 57](#).
5. Edit the image acquisition settings for the job, see "[Editing the image acquisition settings](#)", [page 42](#).
6. If multiple jobs are required for an application, repeat step 3, 4 and 5 for each job.
7. Save the resulting configuration to the device and export the configuration for back-up, see "[Saving, importing and exporting a configuration](#)", [page 47](#).

6.5.1 Saving, importing and exporting a configuration

A configuration includes one or more jobs and a reference image. To save, export or import a configuration, use the buttons in the upper right part of the user interface.



NOTICE

If a configuration is not saved before disconnecting the power to the device, all settings are lost.

Button	Name	Description
	Save permanent	Save a configuration from the device's working memory to the flash memory.
	Export configuration	Export a configuration from the device's working memory to the connected computer.
	Import configuration	Import a configuration from the connected computer and save it to the device's working memory. To save the imported configuration permanently to the device, click Save permanent .

Import configuration

Importing a configuration file also gives the possibility to import permission settings. The option **Application configuration** is mandatory.

Figure 16: Import configuration file and permission settings



NOTE

Permissions can only be selected if the user is logged on as service user level.

6.6 System settings

The **System** page contains a tool tree with tools related to the device interfaces. Tool instances that are added to the **System** tool tree are valid for all jobs.

To access and edit the **System** page, set the **System/Jobs** toggle to **System**.

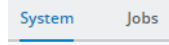

Figure 17: System/Jobs toggle, here set to System

6.6.1 Interfaces tools

The **Interfaces** category contains tools that communicate with external devices. Tools in the **Communication** category can use the **Interfaces** tools for communication and data transmission.

6.6.1.1 Fieldbus tool



The **Fieldbus** tool is a static (non-removable) tool that contains the available fieldbus modes for the device.

Settings

Setting	Description
Mode	<ul style="list-style-type: none"> Select EtherNet/IP to enable EtherNet/IP. Select PROFINET to enable PROFINET. Select Off to inactivate all fieldbus options.
PROFINET station name	The device is identified on the PROFINET network by its station name. This option is only available when PROFINET is selected.



NOTE

Click **Apply and reboot** to restart the device and apply the updated settings.

For more information, see the [EtherNet/IP tool](#) or [PROFINET tool](#) help sections.

6.6.1.2 Camera Connection tool



The tool **Camera Connection** scans for an external camera to connect to. The selected camera is used by the category **Acquisition**, making it possible to configure camera settings and acquire images from the camera.



NOTE

Which cameras the tool can find, depends on the Nova package.

Workflow



NOTE

Use the tool **Power Configuration** to enable power to the camera, see "[Power Configuration tool](#)", page 55.

Selecting a camera

1. Click the button **Select camera**. The scan searches for cameras connected to the interfaces Ethernet 1 and Ethernet 2.

2. Choose a camera in the list and click the button **Select**.
3. The selected camera is shown in the tool **Camera Connection**.

If the camera's IP address is incorrect, click the button **Fix IP**, and change to a compatible IP address.

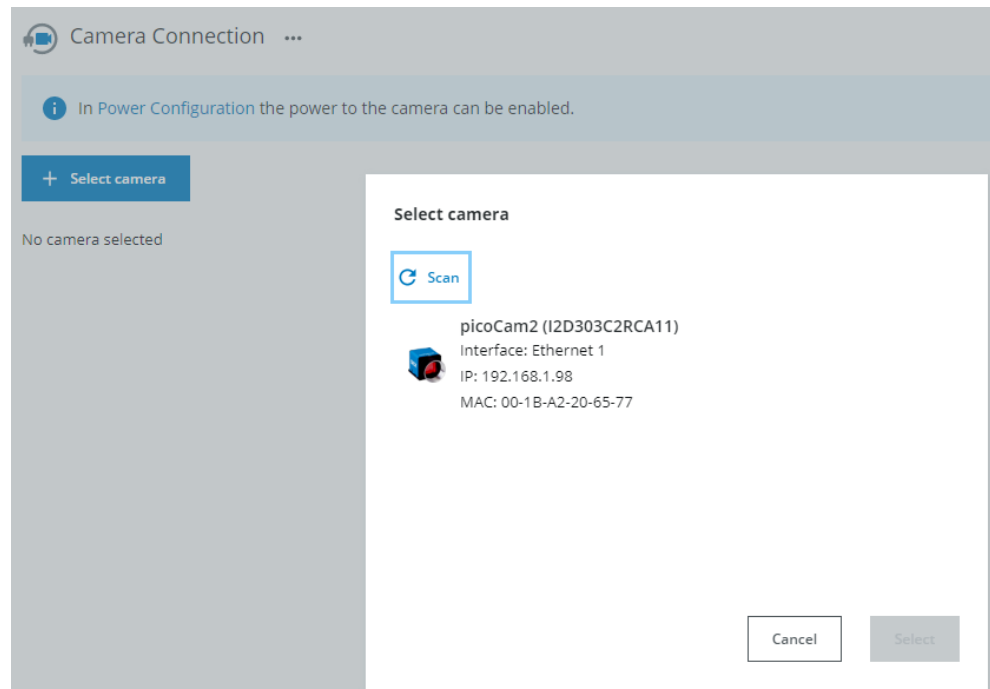

Figure 18: Scanning and selecting a camera

Changing a camera

1. Click the button **Change camera**.
2. Choose another camera and click the button **Select**.

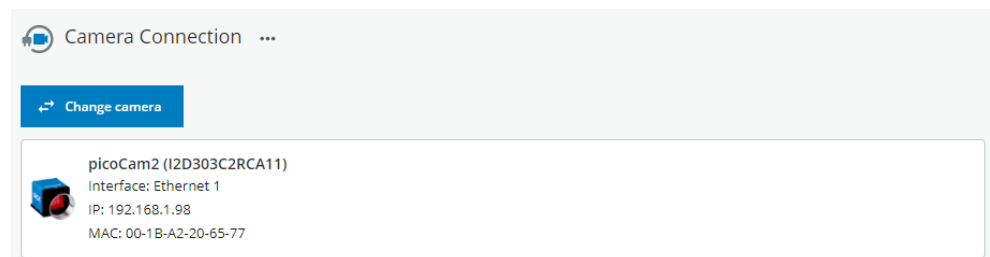

Figure 19: Changing a camera

6.6.1.3 Command Channel tool



The **Command Channel** tool is used to control the camera programmatically from an external source. The **Command Channel** can be run as a **TCP/IP Client**, **TCP/IP Server**, or **Fieldbus**.

The **Fieldbus** version of the **Command Channel** is set up in the tools **PROFINET** or **EtherNet/IP**.



NOTE

Fieldbus functionality can only be used together with devices supporting fieldbus.

Settings

Setting	Description
Interface	List of possible interfaces to select.

TCP/IP Client or server commands

Sending a command:

- Add the command delimiter bytes `stx` (0x02) and `etx` (0x03) to mark the beginning and end of a command.
- Use single spacing between a command and an argument, and between arguments.
- Use quoted text for string arguments and unquoted text for all other argument types.
- Messages sent to the **Command Channel** should be encoded in UTF-8.

Command	Argument	Return	Description
get job		job_id (number)	Get the id of the active job.
set job	job_id	OK or Error message if job id is not found or provided.	Select active job by id.
trigger		OK	Trigger a new image. The External trigger must be set to Command Channel in the active job.
echo	message (string)	message (string)	Return the argument, e.g. for testing connectivity.
set tool parameter/threshold	See below	OK or Error message	Change a parameter value for a tool.
get tool parameter/threshold	See below	OK or Error message	Get a parameter value for a tool.
call tool action_parameter	See below	OK or Error message	Call an action parameter for a tool. Check individual tool help texts for arguments.
replaceReferenceImage		OK or Error message	Replace the reference image and re-teach any locator tools.
saveConfiguration		OK	Save the current configuration.

Supported types

Tool settings, i.e. parameters and thresholds, of the following types can be modified and retrieved:

- String
- Integer (and variants, e.g. range or lower bound)
- Float (and variants, e.g. tolerance or upper bound)
- Degrees
- Range
- References
- Enum

Optional parameters are also supported. Sending a `True` or `False` before the actual values, will enable or disable the parameter. When sending `False`, the values are not needed.

Supported types for call

Action parameters support the following types of arguments:

- String
- Number
- Bool

Number follows the same formatting rules as float.

Formatting values

The following formatting rules apply:

- String settings should be enclosed within quotes for the set-command, and will be enclosed with quotes in the reply for a get-command.
- Integer settings are entered as a plain number, and should not be quoted.
- Float settings use a period (".") as the decimal separator, and should not be quoted.
- For settings that hold a pair of values, such as a range or a tolerance, a comma (",") should be use as delimiter between the values.

TCP/IP Client or server examples**Call action with parameters**

```
<stx>call AIAnomalyDetection:0 Train 0.6 true<etx>
```

Call action without parameters

```
<stx>call AIAnomalyDetection:0 SetOptimalThreshold<etx>
```

Setting a tool parameter or threshold

Use this command to set a parameter for a tool. To set a threshold value, replace parameter with threshold. The device returns OK if successful, or Error: <error description> if not.

```
<stx>set tool <tool instance id> parameter <parameter name> <new value><etx>
```

Use this command to set optional parameter **Scaling** in the tool **Object Locator**:

```
<stx>set tool ObjectLocator:0 parameter ScaleRange true 1 1.05<etx>
```

Use this command to set reference parameter **Feature A** in the tool **Distance** to the point of the tool **Circle Fitter**:

```
<stx>set tool Distance:0 parameter FeatureA CircleFitter:0/Point<etx>
```

Getting a tool parameter or threshold

This command retrieves the current value of a tool parameter. To set a threshold value, replace parameter with threshold. The device replies with OK <parameter value> if successful, or Error: <error description> if not.

```
get tool <tool instance id> parameter <parameter name>
```

Getting a job

Use the following syntax to get the ID of the currently running job:

```
<stx>get job<etx>
```

Selecting a job

Use the following syntax to select job 3:

```
<stx>set job 3<etx>
```

Triggering

Use the following syntax to trigger a new image:

```
<stx>trigger<etx>
```

Testing connectivity

Use the following syntax to test the connectivity:

```
<stx>echo "Test message"<etx>
```

Fieldbus



NOTE

Fieldbus functionality can only be used together with devices supporting fieldbus.

The two supported Fieldbuses are **PROFINET** and **EtherNet/IP**.

See "[Fieldbus tool](#)", page 48 for information on how to enable **PROFINET** or **EtherNet/IP** on the device.

Fieldbus commands

The **Fieldbus Command Channel** is configured in the tools **PROFINET** or **EtherNet/IP**. It also has three static commands available in the control bits for **Trigger**, **Change Job** and **Replace Reference Image**.

Table 4: Command Control bits

Bit	Name	Description
0	Trigger	Trigger image.
1	Change Job	Change job.
2	Replace Reference Image	Replace reference image.
3-5	[Reserved]	Set to 0 (zero).

When setting a new job, the **Job ID Command Data** field must be set before the **Change Job** bit is set in the **Command Control** bits.

A response is sent for each received command. The position and data type assignment of these replies are customizable in the **EtherNet/IP** and **PROFINET** tools.

Table 5: Response Control bits

Bit	Name	Description
0	[Reserved]	
1	[Reserved]	
2	Result ready	Is set to 1 when the analyses are done and result is ready.
3	OK	Is set to 1 if the last command sent was OK.
4	[Reserved]	
5	Error	Is set to 1 if any type of error occurred during the last command.

Error codes

Code	Description
0x0E	Invalid string.
0x14	Value outside range.

Code	Description
0x19	Replace reference image bit set before last replace reference image completed.
0x1E	Invalid enum value.
0x28	No job with provided id exists.
0x33	Invalid tool instance.
0x34	Unknown tool.
0x3A	Shape parameters are out of range.
0x3D	External trigger is not set to Command Channel .
0x3E	In Configure mode but Run triggered not selected.
0x40	Image provider does not support software trigger.
0x41	More than one of trigger, job change and replace reference image bits set.
0x62	Internal error (CALL_FAILED)
0x63	Unknown error.

Fieldbus examples

Example 1:

Change to job 2 from job 4, where job 2 exists. Start by clearing the control bits and setting the data. Afterward, set the change job bit.

	Command		Response		
	Control bits	Data (JobId)	Control bits	Data (JobId)	Error
Clear	0x00	0x02	0x08	0x04	0x00
Set job#2	0x02	0x02	0x08	0x02	0x00

Example 2:

Change to job 2 from job 4, where job 2 does not exist. The setup is the same as in example 1, but this response will contain an error code.

	Command		Response		
	Control bits	Data (JobId)	Control bits	Data (JobId)	Error
Clear	0x00	0x02	0x08	0x04	0x00
Set job#2	0x02	0x02	0x20	0x04	0x28

Example 3:

Trigger an image when **Run** mode is active and the device is configured to be triggered via the **Command Channel**. Start by clearing the control bits. Afterward, set the trigger image control bit.

	Command		Response		
	Control bits	Data (JobId)	Control bits	Data (JobId)	Error
Clear	0x00	-	0x08	0x04	0x00
Trigger	0x01	-	0x08	0x04	0x00

Example 4:

Trigger an image when the device is not configured to be triggered via the **Command Channel**. The setup is the same as in example 3, but this response will contain an error code.

	Command		Response		
	Control bits	Data (JobId)	Control bits	Data (JobId)	Error
Clear	0x00	-	0x08	0x04	0x00
Trigger	0x01	-	0x20	0x04	0x3D

6.6.1.4 I/O Configuration tool



The tool **I/O Configuration** lets the user select the usage for each available digital I/O port.



NOTE

The available options depend on the device.

Settings

Setting	Description
I/O	The port number of the digital I/O.
Usage	Select how to use the port: <ul style="list-style-type: none"> • IN/Image trigger: Use the port as input for external triggering. This option is only available for I/O 1. • IN/Job selection: Use the port as input for the Job Selection I/O tool. • IN/Update ref. image: Use the port as input for updating the reference image. • OUT/Digital output: Use the port as output for the Digital Output tool. • OUT/External light: Use the port as output for external lighting. The available I/O ports depend on the device. When this option is selected, further settings for the external lighting appear in the Acquisition settings.
Logic level	Set the output signal level: <ul style="list-style-type: none"> • Active high (24 V) • Active low (0 V)

6.6.1.5 Job Selection I/O tool



The **Job Selection I/O** tool enables job selection via digital input signals. The tool operates by linking a job to a binary configuration of digital input signals. To select the job, the digital input signals must be correctly set to HIGH and LOW according to the configuration.



NOTE

The **I/O Configuration** tool instance must be added before the **Job Selection I/O** tool can be used. The ports that are set as **IN/Job selection** in the **I/O Configuration** tool are available in the **Job Selection I/O** tool.



NOTE

To select a job, all corresponding input signals must be set to their correct values within 1 ms.

Settings

Setting	Description
Digital input	Each column represents an available digital input port. Each row represents a binary configuration of digital input signals, where "1" corresponds to signal level HIGH and "0" corresponds to signal level LOW. To select a job, all input signal levels on the same row must be set according to the given configuration.
Job	The job that is linked to the configuration of input signals on the current row.

6.6.1.6 Power Configuration tool

The tool **Power Configuration** controls the power output on the device connectors.

Settings**WARNING**

If the camera is connected to both an S connector and an Ethernet connector, do not enable power on both connectors. The camera can be damaged.

Setting	Description
Connector	Lists the connector to enable or disable. The connector is either a sensor connector (S) or an Ethernet connector with Power over Ethernet (POE).
Enabled	Choose to enable or disable the connector.

**NOTE**

On the SIM2x00, the S6 connector is reserved for the fan.

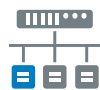
6.6.1.7 TCP Client tool

The **TCP Client** tool sets up an interface for sending data to an external server, using a TCP protocol.

Settings

Setting	Description
Server IP address	The external server's IP address.
Port	The port number to connect to on the external server.

The **Connection status** indicator displays the real-time status of the connection between the **TCP Client** tool and the external server:

- Green indicator: The connection is successfully set up.
- Red indicator: There is no connection to the server.

6.6.1.8 TCP Server tool

The **TCP Server** tool provides a server that external TCP clients can connect to. Data can then be sent from the server to the connected clients using a TCP protocol.

Settings

Setting	Description
Port	The port that the clients can connect to.
Max number of clients	The maximum number of clients allowed to connect.

The **clients connected** indicator shows how many clients that are currently connected to the server.

6.6.2 Calibration tools

The **Calibration** category contains tools for calibration of image data. When a calibration is applied to the image data, values and positions can be expressed as millimeter values in a world coordinate system.

6.6.2.1 Camera Pose Estimation tool



The **Camera Pose Estimation** tool estimates a calibration model for a camera setup. When the calibration model is applied, values and coordinates can be reported as millimeter values in a world coordinate system.

Calibration targets

The **Camera Pose Estimation** tool requires a printed calibration target to estimate a calibration model. The following target types are supported:

- **Plain:** A checkboard target that contains only squares. This target type calibrates the image so that the applied calibration rotates the original image as little as possible (maximum about 45°). When a full calibration is complete, the origin is located between the four squares closest to the middle of the image, according to the figure below.
- **Three dot:** A checkboard target that includes three black dots. The dots are easy to detect, which makes the target suitable for cases with low camera resolution. All three dots must be visible in the camera's field of view during the calibration. When a full calibration is complete, the origin is located in the lower right corner of the square containing the middle dot, according to the figure below.

The calibration targets are available in the SICK Support Portal, supportportal.sick.com.

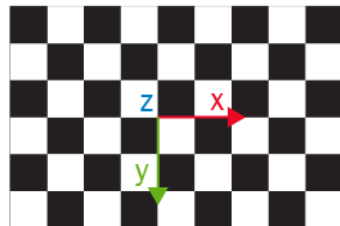

Origin for Plain calibration target

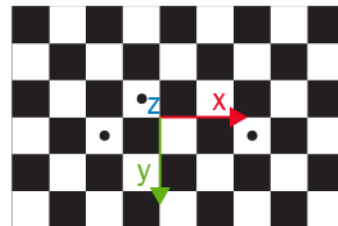

Origin for Three dot calibration target

Settings

Setting	Description
Tile size x, Tile size y	The length of the sides of the squares on the printed calibration target.
Target type	The type of calibration target to use for the pose estimation. See the target descriptions above for details.

Setting	Description
Estimate pose	<p>Estimate a calibration model based on the image currently displayed in the image viewer.</p> <p>Live or playback images can be used for estimating a calibration model. If using live images, position the calibration target in the measurement plane in front of the camera and adjust the Acquisition settings to get a good image.</p> <p>If the pose estimation is successful, a calibration model is created and the mean error for the calibration is displayed in the GUI. If the pose estimation fails, an error message is displayed and no calibration model is created.</p> <p>Once a calibration model is created, use the Image correction options in the Acquisition settings to apply the calibration model to the image data.</p>

6.7 Job settings

The **Jobs** page contains settings for individual jobs. Each job consists of a tool tree and a reference image. The tool tree structure for each job on the **Jobs** page is formed as a workflow, consisting of different categories.

To access and edit the **Jobs** page, set the **System/Jobs** toggle (figure 17) to **Jobs**.

6.7.1 Analysis tools

The **Analysis** category contains tools for image processing and image analysis.

Add a tool to the tool tree by either click a tool, or drag and drop a tool from the tool box (to the left of the tool tree) to the **Analysis** category. Click a tool in the tool tree to display its tool pane, which contains tool settings and results.

If the object rotation and position varies between the acquired images, it is recommended to link each **Analysis** tool to an **Object Locator** tool. To link a tool to the **Object Locator** either first select the **Object Locator** and then click a tool in the tool box, or drag and drop a tool onto an added **Object Locator** tool. Linked tools appear as indented items below the **Object Locator** tool in the tool tree.



NOTE

The available tools depend on the device.

6.7.1.1 AI Anomaly Detection tool



The tool **AI Anomaly Detection** provides functionality to find anomalies in images. To be able to detect anomalies, first images without anomalies from the production environment have to be captured and trained on.

License handling

To access the **AI Anomaly Detection** functionality, you must purchase the Intelligent Inspection Upgrade License. Trial period of 2-hours per reboot enabled for the Intelligent Inspection toolset when installing the Nova 2D SensorApp. The Intelligent Inspection Upgrade License makes it possible to productively use the tools contained in the Intelligent Inspection toolset when installed on certain SICK products. Follow the steps to activate the license:

On a physical device:

1. Open the **System** tab and select **Licensing**.
2. Do you have a license ticket?

- a) Yes. Proceed to step 3.
 - b) No. Click the link to Intelligent Inspection license, for more information about the features. Purchase a license and you will receive a ticket via email. When you have the license ticket, proceed to step 3.
3. Click the button **Open LicenseManager** and follow the instructions.

Settings

Dataset	Description
Annotate images	Opens the Annotate images view where you can upload images and annotate them.
Export dataset	Exports the current dataset to a computer. The images are sorted into different folders depending on their annotation.
Add active image	This button adds the current image in the viewer to the corresponding label, i.e. Good images or Bad images .
Add good, Add bad	Opens a file picker where you can select images that already exist in the device's storage. You can also upload images from your computer. The selected images are added to the corresponding label.
Auto collection	Opens the Auto collection view where you enter settings for collecting images automatically. When the specified Number of images is collected, the images will be saved to the selected Class . If Replace images is selected, the existing images in the class will be removed before saving the collected images.
Number of images	Specify the number of images to acquire.
Class	Select to which class that the images are saved.
Replace images	Select this checkbox to permanently delete all existing images in the selected class before saving the automatically collected images.
Cancel	When Auto collection is started, use the Cancel button to stop the automatic collection without saving any images. A progress bar shows how many images have been acquired.

Training and evaluation	Description
Train...	Opens the training view. Before training you will be prompted on how many of your good images that you want to train on. The rest will be saved for evaluation.
Evaluation	Opens the Evaluation view, where you can see how your trained tool performs on the images saved for evaluation.
Number of training images	The number of good images to be used when training. The maximum number of images is 100.
Tool performance	Use the slider to define how thorough the tool should be during training. The scale goes from Fast to Precise . The selected value affects Input width , Input height , Minimum defect size , Estimated time for training , and Estimated tool execution time .
Strict matching	Strict matching is used when the position or presence of an object is static. If the object moves but still appears in the image, it will be considered as an anomaly. Strict matching is enabled by default. Disable Strict matching if an object or feature is allowed to appear in new positions in the image.
Estimated time for training	Shows a rough estimation of the time needed for training.
Estimated tool execution time	Shows a rough estimation of the time needed for execution.
Input width	The input resolution width to the tool.
Input height	The input resolution height to the tool.

Training and evaluation	Description
Minimum defect size	The minimum defect size in diameter that the tool can detect. This value is only an estimation and practical results may differ depending on use case.
Anomaly score	Set the anomaly score threshold. If an image has an anomaly score above the threshold, it is predicted as bad. If the score is below the threshold, it is predicted as good. Anomaly score is how much the active image differs from the training dataset. It is a positive unbounded scalar value. A small value means little difference.
Show evaluation overlay	Select this checkbox to show the annotation including the tool result for the image. The tool result will show if the tool agrees with the user annotation or not. The overall score for the image is also shown.
Crop image to region	Zooms in to the region where the analysis is performed.
Show heatmap	Select this checkbox to show the image heatmap. The colors in the heatmap go from blue to green to red. The red color shows the parts of the images that differ the most from the good images.
Visualization range	This slider defines the boundaries for the colors in the heatmap.

The status indicator in the header of the **Training and evaluation** section shows the current training status of the tool. The status can be either **Trained** or **Not trained**.

Strict matching

The parameter **Strict matching** controls how the tool **AI Anomaly Detection** handles the positions of objects and features within the region that is trained on.

- If **Strict matching** is on, the tool requires that objects and features remain in the similar positions as they were during training.
- If **Strict matching** is off, objects and features are allowed to move around.

In this example the tool is trained on a coffee mug, with a large static region.

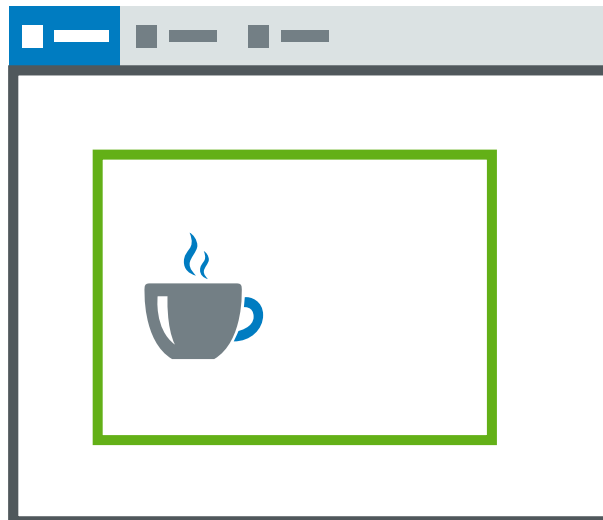

When **Strict matching** is on, objects and features must appear in the same positions as they did in the training images. If an object moves, both the previous position and the new position is considered as an anomaly.



When **Strict matching** is off, the tool does not produce heatmaps if the coffee cup is moved.

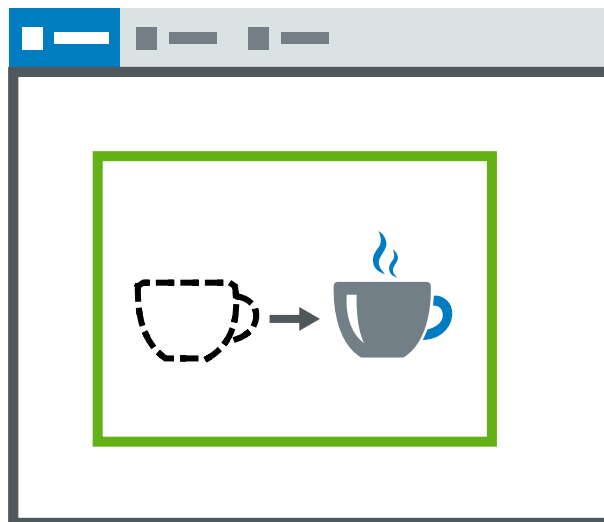

If a completely foreign object with a new appearance enters the ROI, it is marked as an anomaly.

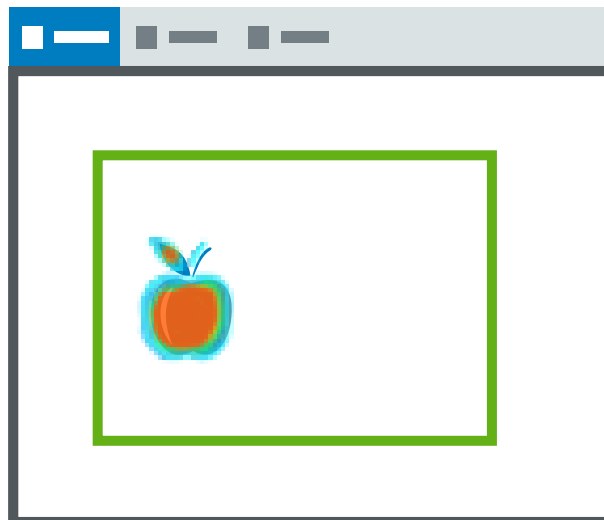

**NOTE**

If the training data contains background, and **Strict matching** is off, the tool does not see this as an anomaly.

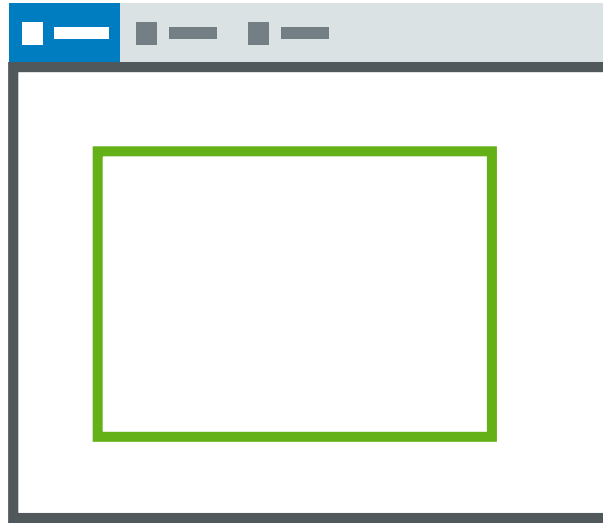
**Results**

Result	Description	Variable name
AutoCollect Number of remaining images	The number of remaining AutoCollection images. When the number is 0, then the automatic collection is either done or not started. This result is not visible in the user interface. The result can be fetched using the tool Result String .	AutoCollectionNumRemainingImages
Anomaly score	Anomaly score is how much the active image differs from the training dataset. It is a positive unbounded scalar value. A small value means little difference.	AnomalyScore
Pass decision	The total result, based on the set threshold value for Anomaly score .	Pass

Image handling**Filtering images**

In the windows **Annotate images** and **Evaluate images**, there is a possibility to filter which images are shown. Use the slider to decide the number of images shown on each row.

Annotate images:

- **All:** Shows all images added to the tools dataset.
- **Good:** Shows all images annotated as good.
- **Bad:** Shows all images annotated as bad.
- **Unclassified:** Shows all images not yet classified.

Evaluate images:

- **All:** Shows all images used in the evaluation.
- **Correct:** Shows all images the tool set as correct.
- **Incorrect:** Shows all images the tool set as incorrect.

Deleting images

It is possible to delete images from the sections **Good images** and **Bad images** in the tool pane. Select the images to delete and click the delete button. This operation can also be performed in the window **Annotate images**.

Workflow

1. Adjusting the ROI

Move the region such that it covers the part of the image where you want to perform anomaly detection. If the detail that you want to analyze can move around, consider using a locator tool such as **Object Locator** to dynamically follow the detail. Everything in the region is considered a feature, including the background. Exclude as much as possible so that the region covers only the area of interest. If you are working with images already saved on your device, use the **Playback** mode to adjust your region.

2. Creating a dataset of images

The **AI Anomaly Detection** tool needs to train on images from the production environment. Only images that are considered good (no anomaly) are used in the training set.

There are three ways to make images available for the anomaly detection tool:

- Add the currently active image.
- Add images from your computer.
- Add images that already exist in the device's storage.

To add the active image, use the button **Add active image** to add images to the corresponding label.

You can add images from your computer or device storage, both in the **Annotate images** view and directly from the tool pane. Click any of the buttons **Add good**, **Add bad**, or **Add unclassified** (only available in the **Annotate images** view), to open a file picker and from there add the images. In the file picker, you have the option to upload images from your computer to the current folder on the device. After uploading, select the files or folders on the device to use.

3. Training the tool

After adding good images to your dataset, you are ready to begin training the tool. When clicking the button **Train...**, you will be prompted to choose the number of good images that you want to use for training. The rest of the images will be reserved for evaluation. Let **Strict matching** be enabled if the position or presence of an object is of importance. If the object is not present in the image, it will be considered as an anomaly since the background appears in a new area.

After you have trained your tool, you can evaluate it on live images or on the evaluation dataset. To evaluate on the images in the evaluation dataset, click on the button **Evaluation**.

4. Evaluating

When clicking the button **Evaluation**, an evaluation will start on the images not trained on, as well as all the bad images. After completing an evaluation on an individual image, the tool will present:

- The user annotation.
- If the prediction is correct or incorrect.
- The anomaly score for the image.

When changing the **Anomaly score** threshold slider, the tool predictions change accordingly. Tool predictions that match the user annotation are evaluated as **Correct**. Tool predictions that do not match the user annotation are evaluated as **Incorrect**.

After choosing a value on the **Anomaly score** threshold that you are satisfied with, save the threshold by pressing **Confirm**. If you do not want to save, press **Cancel**.

Visualization

When the tool is trained, a heatmap is generated for each image. The heatmap can be enabled with the toggle **Show regions and overlays**. Enabling the heatmap adds a considerable overhead to the tool. It is recommended to switch off the heatmap when the tool is used in run mode.

The colors in the heatmap go from blue to green to red. The red color shows the parts of the images that differ the most from the good images. The intensity and colors of actual defects or anomalies are different for every dataset and application. The slider **Visualization range**, defines the boundaries for the colors in the heatmap.

6.7.1.2 AI Classification tool



The tool **AI Classification** provides functionality to classify images. To be able to classify images, a dataset needs to be captured and trained on.

License handling

To access the functionality, you must purchase the Intelligent Inspection Upgrade License. Follow the steps to activate the license.

On a physical device:

1. Open the **System** tab and select **Licensing**.
2. Do you have a license ticket?
 - a) Yes. Proceed to step 3.
 - b) No. Click the link to Intelligent Inspection license, for more information about the features. Purchase a license and you will receive a ticket via email. When you have the license ticket, proceed to step 3.
3. Click the button **Open LicenseManager** and follow the instructions.

Settings

Dataset	Description
Annotate images	Opens the Annotate images view where you can upload images and annotate them.
Export dataset	Exports the current dataset to a computer. The images are sorted into different folders depending on their annotation.
Add active image	This button adds the current image in the viewer to the corresponding class.
Add Class X	Opens a file picker where you can select images that already exist in the device's storage. You can also upload images from your computer. The selected images are added to the corresponding class.
Add class	Add a new class. The new class will be assigned the lowest index available. The maximum number of classes is 10. Hover over the class name to see the class index.

Training and cross validation	Description
Train	Starts the training.
Cross validation	Opens the Cross validation view, where you can see how well your tool understands the dataset.
Show cross validation overlay	Select this checkbox to show the annotation including the tool result for the image. The tool result will show if the tool agrees with the user annotation or not.
Crop image to region	Zooms in to the region where the analysis is performed.
Show region	Select this checkbox to show the image region.

The status indicator in the header of the **Training and cross validation** section shows the current training status of the tool. The status can be either **Trained** or **Not trained**.

The maximum number of images allowed during training is 100. If there are more than 100 images in the dataset, the images for training will be selected from the classes as equally as possible.

The **Dataset statistics** section in the **Cross validation** window shows the evaluation statistics per class. Tips are provided to the user to solve found issues.

Results

Result	Description	Variable name
Class score	The score assigned to the predicted class. Higher score indicates higher similarity to the images in the corresponding class.	ClassScore
Class margin	Indicates the difference between the largest score and the second largest score. A low margin indicates uncertainty in the prediction from the tool.	ClassMargin
Class index	The index of the predicted class.	ClassIndex
Class name	The name of the predicted class.	ClassName
Scores	A graph that visualizes all class scores.	
Pass decision	The total result. A successful classification gives a Pass result.	Pass

Workflow

1. Adjusting the ROI

Move the region such that it covers the part of the image where you want to perform classification. If the detail that you want to analyze can move around, consider using a locator tool such as **Object Locator** to dynamically follow the detail. If you are working with images already saved on your device, use the **Playback** mode to adjust your region.

2. Creating a dataset of images

The tool **AI Classification** needs to train on images from the production environment. There are three ways to make images available for the tool **AI Classification**:

- Add the currently active image.
- Add images from your computer.
- Add images that already exist in the device's storage.

To add the active image, use the button **Add active image** to add images to the corresponding class.

You can add images from your computer or device storage in the **Annotate images** view and directly from the tool pane. Click any of the **Add**-buttons to open a file picker and from there add the images. In the file picker, you have the option to upload images from your computer to the current folder on the device. After uploading, select the files or folders on the device to use.

3. Training the tool

After adding images to your dataset, you are ready to begin training the tool. After you have trained your tool, evaluate the tool and dataset by clicking the button **Cross validation**.

4. Cross validation

When clicking the button **Cross validation**, a cross validation evaluation will start on the images. The evaluation shows how well the tool understands the training data. During cross validation, a cloned classifier is trained while leaving one image out of the training data. This image is used to check if it classifies correctly. Images that are incorrectly marked, are difficult for the tool to understand.

After completing an evaluation on an individual image, the tool will present:

- The user annotation.
- The predicted class, and if the prediction is correct or incorrect.

Tool predictions that match the user annotation are evaluated as **Correct**. Tool predictions that do not match the user annotation are evaluated as **Incorrect**. Each class has an **Accuracy** score, which is the proportion of correctly classified images out of all images in the class. A high accuracy indicates that the tool has a good understanding of the training data in that class. If the accuracy is low, more images might need to be added to the class.

Use the pen icon to reannotate an image. If one or more images are reannotated, the tool must be retrained. Click the button **Save & train** to save the annotations and retrain the tool. If you do not want to save, click **Close** to exit the **Cross validation** window.

Image handling

Filtering images

In the windows **Annotate images** and **Cross validation**, there is a possibility to filter which images are shown. Use the slider to decide the number of images shown on each row.

Annotate images:

- **All**: Shows all images added to the tools dataset.
- **Class "X"**: Shows the images annotated as each respective class.
- **Unclassified**: Shows all images not yet classified.

Cross validation:

- **All**: Shows all images used in the evaluation.
- **Correct**: Shows all images that the tool predicted correctly.
- **Incorrect**: Shows all images that the tool predicted incorrectly.
- **Class "X"**: Shows the images annotated as each respective class.
- **Failed**: Shows all images where the region failed.

Deleting images

It is possible to delete images from the section **Dataset** in the tool pane. Select the images to delete and click the delete button. The images can be deleted from the dataset only, or from the dataset and the device. This operation can also be performed in the window **Annotate images**.

6.7.1.3 AI Classification (dStudio) tool



The tool **AI Classification (dStudio)** is used for classification of acquired images. The use of the tool **AI Classification (dStudio)** requires that a trained neural network is uploaded prior to starting the classification. The resulting class can be communicated with the tool **Send String**.

The tool **AI Classification (dStudio)** enables the usage of trained neural networks from dStudio. For more information about how to get your own network, visit <https://dstudio.cloud.sick.com/>.

License handling

To access the **AI Classification (dStudio)** functionality, you must purchase the Intelligent Inspection Upgrade license. Trial period of 2-hours per reboot enabled for the Intelligent Inspection toolset when installing the Nova 2D SensorApp. The Intelligent Inspection Upgrade License makes it possible to productively use the tools contained in the Intelligent Inspection toolset when installed on certain SICK products. Follow the steps to activate the license:

On a physical device:

1. Open the **System** tab and select **Licensing**.
2. Do you have a license ticket?

- a) Yes. Proceed to step 3.
 - b) No. Click the link to Intelligent Inspection license, for more information about the features. Purchase a license and you will receive a ticket via email. When you have the license ticket, proceed to step 3.
3. Click the button **Open LicenseManager** and follow the instructions.

Settings

Setting	Description
Upload network	Upload a trained neural network to use for the classification. The neural network must be trained by and downloaded as a .json file from the dStudio software.
Loaded network filename	Read-only field that displays the filename of the currently uploaded neural network.
Class labels in network	Read-only field that displays the class labels of the currently uploaded neural network.
Region reference	Reference a specific region produced by a Region tool. If a region is referenced, the image classification is only done on the content within this region. Notes: <ul style="list-style-type: none"> • Only positive rectangular regions can be used for the image classification. If the referenced Region tool contains more than one region, the first positive rectangular region in the list is used. If the Region tool does not contain any positive rectangular regions, an error message appears. • If the position and rotation of the object of interest vary between the acquired images, link the connected Region tool to an Object Locator tool. See the Object Locator tool help for more information.

Output activation depending on AI Classification (dStudio) class name

In order to activate an output depending on the resulting **AI Classification (dStudio)** class name, **Expression** tools are needed. See the **Expression** tool help for examples.

Results

Result	Description	Variable name
Confidence	The neural network's estimation of the probability that the classification of the object in the image is correct.	Confidence
Class index	The index of the class to which the current image belongs, according to the classification. If no network is uploaded, Class index is set to -1.	ClassIndex
Class	The name of the class to which the current image belongs, according to the classification. If no network is uploaded, Class is set to No class .	Class
Pass decision	The total result, based on the following settings: <ul style="list-style-type: none"> • The set threshold value for Confidence. • The uploaded network: If no valid network is uploaded, the Pass decision is set to Fail. • The referenced region: If an invalid or non-existing region is referenced, the Pass decision is set to Fail. 	Pass

Visualization

When the classification for an image is done, the class name and the confidence are displayed on top of the image in the image viewer.

- If a region is referenced, the class name and the confidence are displayed inside the region.
- The class name is displayed in the upper left corner of the image or region.
- The confidence is illustrated as a bar in the right part of the image or region. The higher the confidence, the higher the bar.

6.7.1.4 Angle tool



The **Angle** tool measures the angle, 0 to 180°, between two lines. The smallest angle between the lines in the chosen direction is measured, starting from the reference line.

Settings

Setting	Description
Reference line	The reference line from which the angle is calculated.
Secondary line	The line that has an angle in relation to the reference line.
Select angle direction	Direction: <ul style="list-style-type: none"> • Clockwise measures the angle from the reference line to the secondary line in a clockwise direction. • Counter clockwise measures the angle from the reference line to the secondary line in a counter clockwise direction.

Results

Result	Description	Variable name
Angle (deg)	The angle between the lines in degrees. The angle is between 0 and 180 degrees. Set which result is Expected and the Tolerance for the decision to pass.	Angle
Intersection point	The point, which is located where the two lines intersect.	Point
Pass decision	A valid angle measurement gives a Pass result.	Pass

Wrap-around effect

When validating that two lines are almost parallel there is a wrap-around effect to consider. Setting the **Expected** value to 0, but allowing a positive and negative **Tolerance**, will accept a result above 0° and below 180° as a valid angle measurement.

Example:

If the **Expected** value is 0 and the **Tolerance** is set to ±1, both 0-1° and 179-180° will be accepted as valid angle measurements.

6.7.1.5 Bead tool



The **Bead** tool verifies completeness, position and width tolerance of string-formed features, for example, glue beads. The reference position of the bead is configured with a polyline, with points placed along the center line of the reference bead.

To handle a curved bead string, additional points can be added by clicking on the bead when the yellow plus sign marker is shown. Right-click on a point to remove it.

**NOTE**

If the object position varies between the acquired images, this tool must be linked to a locator tool. Tools which are linked to a locator tool are repositioned according to the position of the located object. Drag and drop a created tool onto an added locator tool to link them.

Settings

Setting	Description
Bead intensity	The intensity of the bead string. Set this value to Bright if the bead is brighter than the background, and Dark if the bead is darker than the background. Use the option Both when the bead changes polarity along the bead and is sometimes brighter than the background and sometimes darker than the background
Threshold	Set the required contrast of the edges, that is, the minimum difference in intensity between the dark side and the bright side of an edge. A high value means that higher contrast is required between the bright and dark sides of an edge.
Width search range	The range for how much the bead width is allowed to vary.
Position search range +/-	Defines how much the position of the bead is allowed to differ from the reference polyline.
Distance between probes	The distance between the probes along the polyline. A short probe distance will provide a more precise trace of the bead string, but also increase the runtime.

Visual aid

The areas where the **Bead** tool searches for edges are marked by yellow rectangles along the polyline.

The **Position search range** is shown as a blue line in the middle of each polyline segment.

The result of each probe search is shown in the viewer. Bead edge pairs within the thresholds are shown as yellow dots and as red dots if too narrow or too wide. A red cross placed on the configuration polyline marks a probe where no edge is found.

The detected bead is marked by a polyline. Valid segments are green and segments outside the tolerances or without a valid edge pair are red. In **Run** mode only the edges are shown.

Results

Result	Description	Variable name
Mean width	The mean width of the bead.	MeanWidth
Total too wide probes	The number of probe points where the bead is wider than the width search range.	TooWide
Total too narrow probes	The number of probe points where the bead is narrower than the width search range.	TooNarrow
Total not found probes	The number of probe points where where none or only one of the edges in a bead edge pair could be found.	NotFound
Max consecutive too wide probes	The number of consecutive probe pairs that are wider than the width search range.	TooWideInSequence
Max consecutive too narrow probes	The number of consecutive probe pairs that are narrower than the width search range.	TooNarrowInSequence

Result	Description	Variable name
Max consecutive not found probes	The number of consecutive probe pairs where none or only one of the edges in a bead edge pair could be found. This tolerance is useful for detecting gaps in the bead.	NotFoundInSequence
Position tolerance	The maximum number of pixels the bead is moved in any direction from the position of the reference bead center line.	MaxPositionDeviation
Pass decision	Total result, based on the set threshold values for all the other tool results.	Pass

6.7.1.6 Blob Finder tool



The tool **Blob Finder** finds and counts blobs within its region of interest. A blob is defined as a cluster of connected pixels within a specified intensity and area range.



NOTE

If the object position varies between the acquired images, this tool must be linked to a locator tool. Tools which are linked to a locator tool are repositioned according to the position of the located object. Drag and drop a created tool onto an added locator tool to link them.

Settings

Setting	Description
Intensity	Only search for pixels with an intensity value within the specified intensity range.
Area	Only include blobs with an area within the specified area range.
Sort by	Select in which order the found blobs should be sorted. The possible choices are: <ul style="list-style-type: none"> • Area • Center of gravity X • Center of gravity Y • Height • Width
Order	Select between Ascending or Descending sorting order.

Advanced setting	Description
Circularity	A circularity measure that is 100 for ideal circles and smaller for other shapes. The measure is robust to high-frequency noise like jagged edges along the circle perimeter, so even noisy circles get a measure close to 100. The measure is significantly lower if the overall appearance is rather an ellipse, square or other non-circular shapes.
Compactness	The compactness measure of the blob ($4 * \text{PI} * \text{Area} / \text{Perimeter}^2$). This is close to 100 for circles and smaller for less compact blobs.
Convexity	The convexity measure of the blob (blob area divided by area of convex hull). This is 100 for convex blobs and smaller the more non-convex the blob is.
Number of holes allowed	Enable this parameter to specify the number of holes allowed inside the blob.
Remove blobs touching border	Select this checkbox to exclude blobs touching the region border.

Regions

This tool operates within its region of interest (ROI), which is set in the **Regions** section in the tool pane. For more information about how to set the ROI, see "[Setting the region of interest for a tool](#)", page 45.

Results

Result	Description	Variable name
Number of blobs	The number of found blobs.	NumBlobs
Blobs	List containing width, height, area, and center of gravity of all found blobs.	Blobs
Pass decision	Total result, based on the set threshold value for Number of blobs .	Pass

6.7.1.7 Blob Finder Color tool



The tool **Blob Finder Color** finds and counts blobs within its region of interest. A blob is defined as a cluster of connected pixels within a specified color and area range.



NOTE

This tool can only be used together with color variants of picoCam2 or midiCam2.



NOTE

If the object position varies between the acquired images, this tool must be linked to a locator tool. Tools which are linked to a locator tool are repositioned according to the position of the located object. Drag and drop a created tool onto an added locator tool to link them.

Settings

Setting	Description
Color	Only search for pixels with a color value within the specified color range. To specify the color range, set values for: <ul style="list-style-type: none"> • Color (h): Specify a color (hue) value and a tolerance. The selected range is shown on top of the color gradient. • Saturation (s): Specify the saturation (saturation) range. • Brightness (v): Specify the brightness (value) range.
Area	Only include blobs with an area within the specified area range.
Sort by	Select in which order the found blobs should be sorted. The possible choices are: <ul style="list-style-type: none"> • Area • Center of gravity X • Center of gravity Y • Height • Width
Order	Select between Ascending or Descending sorting order.

Advanced setting	Description
Circularity	A circularity measure that is 100 for ideal circles and smaller for other shapes. The measure is robust to high-frequency noise like jagged edges along the circle perimeter, so even noisy circles get a measure close to 100. The measure is significantly lower if the overall appearance is rather an ellipse, square or other non-circular shapes.
Compactness	The compactness measure of the blob ($4 * \pi * \text{Area} / \text{Perimeter}^2$). This is close to 100 for circles and smaller for less compact blobs.
Convexity	The convexity measure of the blob (blob area divided by area of convex hull). This is 100 for convex blobs and smaller the more non-convex the blob is.
Number of holes allowed	Enable this parameter to specify the number of holes allowed inside the blob.
Remove blobs touching border	Select this checkbox to exclude blobs touching the region border.

Regions

This tool operates within its region of interest (ROI), which is set in the **Regions** section in the tool pane. For more information about how to set the ROI, see ["Setting the region of interest for a tool"](#), page 45.

Results

Result	Description	Variable name
Number of blobs	The number of found blobs.	NumBlobs
Blobs	List containing width, height, area, and center of gravity of all found blobs.	Blobs
Pass decision	Total result, based on the set threshold value for Number of blobs .	Pass

6.7.1.8 Blob Locator tool



The tool **Blob Locator** locates an object using blob matching. A blob is a defined cluster of connected pixels within a specified intensity range. Use this tool to locate objects in cases where no consistent patterns, textures, or edge information are available.

The tool **Blob Locator** requires a reference image for manual selection of a reference blob by using a point. Once a yellow blob is selected, the blob color will turn blue and teach is complete. Using the area tolerance and the tolerances under the advanced section it is possible to filter the live blobs. The live blob selected for locating an object is, after filtering, the one inside the search region with most similar area to the reference blob. For each new image, the tool **Blob Locator** outputs the position translation components and rotation angle of the located blob relative to the reference blob.



NOTE

If the object position varies between the acquired images, this tool must be linked to a locator tool. Tools which are linked to a locator tool are repositioned according to the position of the located object. Drag and drop a created tool onto an added locator tool to link them.

Settings

Setting	Description
Intensity	Only search for pixels with an intensity value within the specified intensity range.
Area tolerance	Use the area tolerance to filter blobs found in the live images. The filtering is performed in relation to the reference blob that corresponds to a value of 100%. For example: If the Area tolerance is set to 80% and 120%, matching of reference blob will be made to blobs in live image which have an area between 80% to 120% of the reference blob.
Rotation (±)	The maximum allowed blob rotation in relation to the reference blob. When rotation is disabled, only a translation is calculated. If rotation is enabled, the tool will work better for elongated blobs. The default value is 180°. Circular or square blobs might not be possible to locate if rotation is enabled. Limiting the rotation range to 90°, can be useful when dealing with symmetric blobs, otherwise the highest rotation range should be used.
Search region	Selecting this checkbox shows the search region in the viewer, and makes it editable. The search region covers the whole viewer by default and is shown as a blue border. Defining a smaller search region increases speed as only a subset of the live image is used to extract blob candidates for the localization. The reference blob and the live blob match with the highest score is selected when calculating.

Advanced setting	Description
Circularity tolerance (±)	Enable to filter blobs found in live images. The filtering is performed in relation to the reference blob. The measure is robust to high-frequency noise like jagged edges along the circle perimeter. The measure is significantly lower if the overall appearance is rather an ellipse, square or other non-circular shape.
Compactness tolerance (±)	Enable to filter blobs found in live images. The filtering is performed in relation to the reference blob. The compactness value is highest for circles and decrease for less compact blobs, but not as much as with the parameter Circularity tolerance .
Convexity tolerance (±)	Enable to filter blobs found in live images. The filtering is performed in relation to the reference blob. The convexity value is highest for convex blobs and smallest for concave blobs.
Number of holes tolerance (±)	Enable to filter blobs found in live images. The filtering is performed in relation to the number of holes in the reference blob.

Results

Result	Description	Variable name
Match score	The percentage of matching between the located blob and the reference blob, indicating the quality of the located object.	MatchScore
Angle	The angle of the located blob compared to the reference blob.	Angle
Translation X	The X-translation of the located blob, compared to the reference blob.	TranslationX
Translation Y	The Y-translation of the located blob, compared to the reference blob.	TranslationY

Result	Description	Variable name
Pass decision	The total result, based on the set threshold values for Match score and Angle .	Pass

6.7.1.9 Blob Locator Color tool



The tool **Blob Locator Color** locates an object using blob matching. A blob is a defined cluster of connected pixels within a specified color range. Use this tool to locate objects in cases where no consistent patterns, textures, or edge information are available.

The tool **Blob Locator Color** requires a reference image for manual selection of a reference blob by using a point. Once a yellow blob is selected, the blob color will turn blue and teach is complete. Using the area tolerance and the tolerances under the advanced section it is possible to filter the live blobs. The live blob selected for locating an object is, after filtering, the one inside the search region with most similar area to the reference blob. For each new image, the tool **Blob Locator Color** outputs the position translation components and rotation angle of the located blob relative to the reference blob.



NOTE

This tool can only be used together with color variants of picoCam2 or midiCam2.



NOTE

If the object position varies between the acquired images, this tool must be linked to a locator tool. Tools which are linked to a locator tool are repositioned according to the position of the located object. Drag and drop a created tool onto an added locator tool to link them.

Settings

Setting	Description
Color	Only search for pixels with an intensity value within the specified color range. <ul style="list-style-type: none"> • Color (h): Specify a color (hue) value and a tolerance. The selected range is shown on top of the color gradient. • Saturation (s): Specify the saturation (saturation) range. • Brightness (v): Specify the brightness (value) range.
Area tolerance	Use the area tolerance to filter blobs found in the live images. The filtering is performed in relation to the reference blob that corresponds to a value of 100%. For example: If the Area tolerance is set to 80% and 120%, matching of reference blob will be made to blobs in live image which have an area between 80% to 120% of the reference blob.
Rotation (±)	The maximum allowed blob rotation in relation to the reference blob. When rotation is disabled, only a translation is calculated. If rotation is enabled, the tool will work better for elongated blobs. The default value is 180°. Circular or square blobs might not be possible to locate if rotation is enabled. Limiting the rotation range to 90°, can be useful when dealing with symmetric blobs, otherwise the highest rotation range should be used.

Setting	Description
Search region	Selecting this checkbox shows the search region in the viewer, and makes it editable. The search region covers the whole viewer by default and is shown as a blue border. Defining a smaller search region increases speed as only a subset of the live image is used to extract blob candidates for the localization. The reference blob and the live blob match with the highest score is selected when calculating.
Advanced setting	Description
Circularity tolerance (±)	Enable to filter blobs found in live images. The filtering is performed in relation to the reference blob. The measure is robust to high-frequency noise like jagged edges along the circle perimeter. The measure is significantly lower if the overall appearance is rather an ellipse, square or other non-circular shape.
Compactness tolerance (±)	Enable to filter blobs found in live images. The filtering is performed in relation to the reference blob. The compactness value is highest for circles and decrease for less compact blobs, but not as much as with the parameter Circularity tolerance .
Convexity tolerance (±)	Enable to filter blobs found in live images. The filtering is performed in relation to the reference blob. The convexity value is highest for convex blobs and smallest for concave blobs.
Number of holes tolerance (±)	Enable to filter blobs found in live images. The filtering is performed in relation to the number of holes in the reference blob.

Results

Result	Description	Variable name
Match score	The percentage of matching between the located blob and the reference blob, indicating the quality of the located object.	MatchScore
Angle	The angle of the located blob compared to the reference blob.	Angle
Translation X	The X-translation of the located blob, compared to the reference blob.	TranslationX
Translation Y	The Y-translation of the located blob, compared to the reference blob.	TranslationY
Pass decision	The total result, based on the set threshold values for Match score and Angle .	Pass

6.7.1.10 Circle Fitter tool



The **Circle Fitter** tool searches for an edge of a circle in the image data and fits a circle to that edge.

The search direction for the **Circle Fitter** tool is from the inner circle to the outer circle of the search region.



NOTE

If the object position varies between the acquired images, this tool must be linked to a locator tool. Tools which are linked to a locator tool are repositioned according to the position of the located object. Drag and drop a created tool onto an added locator tool to link them.

Settings

Setting	Description
Inner and outer diameter	The inner and outer diameter controls the diameters of the search region.
Polarity	The transition of the edge in the search direction: from dark to bright, from bright to dark, or any.
Edge strength	The threshold value for detecting an edge. A high value means that a higher contrast is required between the bright and dark side of an edge.

Advanced setting	Description
Edge selection	If multiple edges are located, the Edge selection setting determines whether to select the strongest, first or last edge found within the region of interest, with regard to the search direction.
Outlier margin	Outlier margin sets a margin outside of the found circle. The probes that lie within this margin are set as inliers, i.e. accepted and contributes to the circle fit, and the probes outside of the margin are discarded. In effect, a higher value increases the probability of locating an edge, but the located edge may be noisy or not close enough to fit the edge of a perfect circle. A low Outlier margin value ignores noisy edges and edges that are not close enough to a perfect circle.
Edge fuzziness	Increasing Edge fuzziness can improve the accuracy for very blurred edges, where there is no sharp transition from dark to bright (or vice versa).
Number of probes	The Number of probes parameter sets how many probes that are sent to detect an edge. A larger value gives higher accuracy but might increase calculation time, whereas a lower value gives lower accuracy but increases speed.

Results

Result	Description	Variable name
Diameter	The diameter of the fitted circle. Set which result is Expected and the Tolerance for the decision to pass.	Diameter
Average error	The average distance, in pixels, between the fitted edge and the identified image edge points. A noisy or wave-shaped edge gives a large error.	MeanError
Edge detection	A high value means that the located edge extends over a large part of the region of interest.	EdgeDetection
Center point	The center point of the fitted circle.	Point
Pass decision	The total result, based on the set threshold values for Diameter , Average error and Edge detection .	Pass

6.7.1.11 Distance tool



The **Distance** tool measures the distance between two features. Each feature must be either a point or a line. The center of circles and ellipses can also be used as point features.

Settings

Setting	Description
Feature A	The first referenced feature (point or line) for the distance measurement.
Feature B	The second referenced feature (point or line) for the distance measurement.
Measurement type	<p>The type of measurement:</p> <ul style="list-style-type: none"> • Point to point measures the distance between two points. For line features, the point is projected onto the center of the line. • Right angle measures the orthogonal distance between a point feature and a line feature. <p>Right angle measurements require that at least one of the referenced features is a line. If both features are lines, the center point of Feature B is used as point feature.</p>

Results

Result	Description	Variable name
Distance	The distance between the referenced features. If the Image correction mode is set to Full calibration , the distance is expressed as a millimeter value. Otherwise, the distance is expressed as a pixel value. Set which result is Expected and the Tolerance for the decision to pass.	Distance
Pass decision	A valid distance measurement gives a Pass result.	Pass

6.7.1.12 Edge Pixel Counter tool

The **Edge Pixel Counter** tool counts all pixels which are located on edges within the tool's region of interest.

**NOTE**

If the object position varies between the acquired images, this tool must be linked to a locator tool. Tools which are linked to a locator tool are repositioned according to the position of the located object. Drag and drop a created tool onto an added locator tool to link them.

Settings

Setting	Description
Edge strength	Threshold value for detecting an edge. A high edge strength means that a high contrast is required between an edge and the background.

Regions

This tool operates within its region of interest (ROI), which is set in the **Regions** section in the tool pane. For more information about how to set the ROI, see "[Setting the region of interest for a tool](#)", page 45.

Results

Result	Description	Variable name
Coverage	The number of found edge pixels in relation to the total number of pixels within the region of interest.	Coverage
Number of pixels	The number of found edge pixels within the tool's region of interest.	NumPixels
Pass decision	Total result, based on the set threshold values for Coverage.	Pass

6.7.1.13 Ellipse Fitter tool



The **Ellipse Fitter** tool searches for an edge of an ellipse in the image data and fits an ellipse to that edge.

The search direction for the **Ellipse Fitter** tool is from the inner circle to the outer circle of the search region.



NOTE

If the object position varies between the acquired images, this tool must be linked to a locator tool. Tools which are linked to a locator tool are repositioned according to the position of the located object. Drag and drop a created tool onto an added locator tool to link them.

Settings

Setting	Description
Inner and outer diameter	The inner and outer diameter controls the diameters of the search region.
Polarity	The transition of the edge in the search direction: from dark to bright, from bright to dark, or any.
Edge strength	The threshold value for detecting an edge. A high value means that a higher contrast is required between the bright and dark side of an edge.
Advanced setting	Description
Edge selection	If multiple edges are located, the Edge selection setting determines whether to select the strongest, first or last edge found within the region of interest, with regard to the search direction.
Outlier margin	Outlier margin sets a margin outside of the found ellipse. The probes that lie within this margin are set as inliers, i.e. accepted and contributes to the circle fit, and the probes outside of the margin are discarded. In effect, a higher value increases the probability of locating an edge, but the located edge may be noisy or not close enough to fit the edge of a perfect circle. A low Outlier margin value ignores noisy edges and edges that are not close enough to a perfect ellipse.
Edge fuzziness	Increasing Edge fuzziness can improve the accuracy for very blurred edges, where there is no sharp transition from dark to bright (or vice versa).
Number of probes	The Number of probes parameter sets how many probes that are sent to detect an edge. A larger value gives higher accuracy but might increase calculation time, whereas a lower value gives lower accuracy but increases speed.

Results

Result	Description	Variable name
Largest diameter	The largest diameter of the fitted ellipse. Set which result is Expected and the Tolerance for the decision to pass.	DiameterMax
Smallest diameter	The smallest diameter of the fitted ellipse. Set which result is Expected and the Tolerance for the decision to pass.	DiameterMin
Average error	The average distance, in pixels, between the fitted edge and the identified image edge points. A noisy or wave-shaped edge gives a large error.	MeanError
Edge detection	A high value means that the located edge extends over a large part of the region of interest.	EdgeDetection
Center point	The center point of the fitted ellipse.	Point
Pass decision	The total result, based on the set threshold values for Largest diameter , Smallest diameter , Average error and Edge detection .	Pass

6.7.1.14 Fixed Line tool



The **Fixed Line** tool creates a reference line between two features in the image. The reference line defined by a **Fixed Line** tool can be used by other tools such as the **Distance** and **Angle** tools.

Settings

Setting	Description
Feature A	The first referenced feature, which can be either point or line.
Feature B	The second referenced feature, which can be either point or line.

Results

Result	Description	Variable name
Pass decision	A Pass result means that the reference line is valid.	Pass

6.7.1.15 Fixed Point tool



The **Fixed Point** tool creates a reference point in the image, based on coordinates set by the user. The reference point defined by a **Fixed Point** tool can be used by other tools such as the **Distance** tool.



NOTE

If the object position varies between the acquired images, this tool must be linked to a locator tool. Tools which are linked to a locator tool are repositioned according to the position of the located object. Drag and drop a created tool onto an added locator tool to link them.

Results

Result	Description	Variable name
Point	The point result shows the point coordinates (x, y).	Point

Result	Description	Variable name
Pass decision	A Pass result means that the reference point position is valid.	Pass

6.7.1.16 Line Fitter tool



The **Line Fitter** tool searches for a straight edge in the image data and fits a line to that edge.

The search direction for the **Line Fitter** tool is defined by blue arrows, displayed in the image viewer. The **Line Fitter** tool searches for edges that are perpendicular to the arrows. Rotate the region of interest to change the search direction.



NOTE

If the object position varies between the acquired images, this tool must be linked to a locator tool. Tools which are linked to a locator tool are repositioned according to the position of the located object. Drag and drop a created tool onto an added locator tool to link them.

Settings

Setting	Description
Polarity	The transition of the edge in the search direction: from dark to bright, from bright to dark, or any.
Edge strength	The threshold value for detecting an edge. A high value means that a higher contrast is required between the bright and dark side of an edge.
Advanced setting	Description
Edge selection	If multiple edges are located, the Edge selection setting determines whether to select the strongest, first or last edge found within the region of interest, with regard to the search direction.
Outlier margin	Outlier margin sets a margin outside of the found line. The probes that lie within this margin are set as inliers, i.e. accepted and contributes to the line fit, and the probes outside of the margin are discarded. In effect, a higher value increases the probability of locating an edge, but the located edge may be noisy or not perfectly straight. A low Outlier margin value ignores noisy edges and edges that are not straight enough. This parameter was previously named Edge quality where low setting was set to 30, medium to 10 and high to 3.
Edge fuzziness	Increasing Edge fuzziness can improve the accuracy for very blurred edges, where there is no sharp transition from dark to bright (or vice versa). The Edge fuzziness is always in pixels, even if calibration is used.
Number of probes	The Number of probes parameter sets how many probes that are sent to detect an edge. A larger value gives higher accuracy but might increase calculation time, whereas a lower value gives lower accuracy but increases speed.

Regions

This tool operates within its region of interest (ROI), which is set in the **Regions** section in the tool pane. For more information about how to set the ROI, see ["Setting the region of interest for a tool"](#), page 45.

The **Line Fitter** tool is only intended to work within one single positive region. If more than one region is added, the tool may not work properly.

Results

Result	Description	Variable name
Average error	The average distance, in pixels, between the fitted edge and the identified image edge points. A noisy or wave-shaped edge gives a large error.	MeanError
Edge detection	A high value means that the located edge extends over a large part of the region of interest.	EdgeDetection
Center	The center point of the fitted line.	LineCenter
Pass decision	The total result, based on the set threshold values for Average error and Edge detection .	Pass

6.7.1.17 Object Locator tool



The **Object Locator** tool locates an object using edge matching defined by clear contours. Use the **Object Locator** tool when the position or rotation of the object varies, to move attached tools for inspection correspondingly.

Reference image

The **Object Locator** tool requires a reference image for teach-in of a reference object and for setting the region of interest. Teach-in is done automatically when a reference image is added or updated. For each new image, the **Object Locator** tool produces a transform that describes how the located object's position and rotation vary relative to the reference image.

- Click **Update Reference Image** to add or update the reference image. The teach-in of the reference object is automatically done on the updated image.
- Click **View Reference Image** to display the current reference image and set the ROI for the tool.

Linking other tools to the Object Locator

Select the **Object Locator** tool in the tool tree. Click or Drag and drop a tool instance onto an **Object Locator** tool instance to create a parent-child relationship. For each new image, the region of interest for each child tool is repositioned according to the transform produced by the parent **Object Locator** tool. Tools that are linked as children appear as indented items below the **Object Locator** tool instance in the tool tree.

Settings

Setting	Description
Edge strength	Threshold value for locating an edge. A high value means that a high contrast is required between an edge and the background. An optimal edge strength value includes the edges of the reference object while excluding clutter edges in the background.
Background clutter	Controls the robustness to clutter and details in the background that is not part of the reference object. There are three levels LOW, MEDIUM, and HIGH. If the background is clean, use the LOW setting to make the tool faster. If there are many other fine structures in the image, use the HIGH setting.
Rotation (±)	The maximum allowed object rotation in relation to the reference object. Decrease the allowed rotation to increase the speed and robustness of the analysis.

Setting	Description
Scaling	Search for objects which are scaled in relation to the reference object. Scaling is suitable if the distance between the object and the sensor varies. Avoid using this option when the object size is constant, to increase the speed and robustness of the analysis.
Downsampling	Controls the speed when locating an object by downsampling the input image. Higher downsampling gives a faster analysis. Some downsampling can be beneficial for robustness as it removes small noise structures, but too large downsampling will remove the relevant object contours. The final accuracy when locating an object is not affected by the downsampling parameter.
Search region	Selecting this checkbox shows the search region in the viewer, and makes it editable. The search region covers the whole viewer by default and is shown as a blue border. Defining a smaller search region increases speed as only a subset of positions are evaluated in the search. It also increases robustness as false matches with edges outside the search region are discarded. The object itself can extend outside the search region, it is the center of the object that needs to be within the search region.

Regions

This tool operates within its region of interest (ROI), which is set in the **Regions** section in the tool pane. For more information about how to set the ROI, see "[Setting the region of interest for a tool](#)", page 45.

To get the best possible robustness, make the **Object Locator** ROI as large part of the image as possible. Only include features that are stable and unchanged between the acquired images.

Results

Result	Description	Variable name
Match score	The percentage of matching between the taught reference object and the current object, indicating the quality of the located object.	MatchScore
Angle	The angle of the current object compared to the reference object.	Angle
Scale	The scale of the current object in relation to its size in the reference image.	Scale
Translation X	The X-translation of the current object, compared to the reference object.	TranslationX
Translation Y	The Y-translation of the current object, compared to the reference object.	TranslationY
Pass decision	The total result, based on the set threshold values for Match score and Angle .	Pass

6.7.1.18 Pattern Locator tool



The **Pattern Locator** tool locates an object based on landmark points. The **Pattern Locator** tool works best for fine-detailed patterns and textures from which a set of unique landmark points can be extracted. Use this tool when locating object with a pattern where the position, rotation, or scale of the object varies, to move attached tools for inspection correspondingly. The **Pattern Locator** tool also handles perspective variations very well, e.g. if the camera is tilted.

Reference image

The **Pattern Locator** tool requires a reference image for teach-in of a pattern to locate. The teach-in is done automatically when a reference image is added or updated. The teach-in process extracts landmark points from the entire reference image, marked by yellow crosses in the viewer. The number of points to extract is controlled by the **Background clutter** setting. An automatically selected set of points within the teach region, marked by blue points, is used for locating objects in new images. For each new image, the **Pattern Locator** tool outputs the position, rotation, and scale of the located pattern relative to the reference image.

- Click **Update Reference Image** to add or update the reference image. The teach-in of the reference object is automatically done on the updated image.
- Click **View Reference Image** to display the current reference image and set the ROI for the tool.

Linking other tools to the Pattern Locator

Select the **Pattern Locator** tool in the tool tree. Click or Drag and drop a tool instance onto a **Pattern Locator** tool instance to create a parent-child relationship. For each new image, the region of interest for each child tool is repositioned according to the transform produced by the parent **Pattern Locator** tool. Tools that are linked as children appear as indented items below the **Pattern Locator** tool instance in the tool tree.

Settings

Setting	Description
Background clutter	Controls the robustness to clutter and details in the background that is not part of the reference pattern. There are three levels LOW, MEDIUM, and HIGH that adjust the number of landmark points used when locating. If the background is clean, use the LOW setting to make the tool faster. If there are many other fine structures in the image, use the HIGH setting.
Rotation (±)	The maximum allowed pattern rotation in relation to the reference pattern. Decrease the rotation range as much as possible to increase robustness of the analysis.
Scaling	Search for patterns that are scaled in relation to the reference pattern, e.g. if the distance to the camera varies. Avoid using this option when the pattern size is constant, to increase the robustness of the analysis.
Downsampling	Controls the speed when locating by downsampling the input image. Higher downsampling gives a faster analysis, but may reduce positioning accuracy and robustness. Some downsampling can be beneficial for robustness as it removes small noise structures, but too large downsampling will remove the relevant pattern details.
Search region	Selecting this checkbox shows the search region in the viewer, and makes it editable. The search region covers the whole viewer by default and is shown as a blue border. Defining a smaller search region increases speed as only a subset of positions are evaluated in the search. It also increases robustness as false matches with points outside the search region are discarded. The pattern itself can extend outside the search region, it is the center of the pattern that needs to be within the search region.

Regions

This tool operates within its region of interest (ROI), which is set in the **Regions** section in the tool pane. For more information about how to set the ROI, see "[Setting the region of interest for a tool](#)", page 45.

To get the best possible robustness, define a teach-in ROI that covers a unique pattern that is stable between images. It is more reliable to locate a larger pattern than a smaller pattern.

Results

Result	Description	Variable name
Match score	The percentage of matching between the located pattern and reference pattern, indicating the quality of the located pattern.	MatchScore
Angle	The angle of the located pattern, compared to the reference pattern.	Angle
Scale	The scale of the located pattern in relation to its size in the reference image.	Scale
Translation X	The X-translation of the located pattern, compared to the reference pattern.	TranslationX
Translation Y	The Y-translation of the located pattern, compared to the reference pattern.	TranslationY
Pass decision	The total result, based on the set threshold values for Match score and Angle .	Pass

6.7.1.19 Pixel Counter tool



The **Pixel Counter** tool counts the pixels in a specified intensity range within the tool's region of interest.



NOTE

If the object position varies between the acquired images, this tool must be linked to a locator tool. Tools which are linked to a locator tool are repositioned according to the position of the located object. Drag and drop a created tool onto an added locator tool to link them.

Settings

Setting	Description
Intensity	Only include pixels that have an intensity value within the specified range.

Regions

This tool operates within its region of interest (ROI), which is set in the **Regions** section in the tool pane. For more information about how to set the ROI, see "[Setting the region of interest for a tool](#)", page 45.

Results

Result	Description	Variable name
Coverage	The percentage of pixels within the specified Intensity range, in relation to the total number of pixels in the tool's region of interest.	Coverage

Result	Description	Variable name
Number of pixels	The number of pixels within the specified Intensity range in the tool's region of interest.	NumPixels
Pass decision	Total result, based on the set threshold values for Coverage .	Pass

6.7.1.20 Pixel Counter Color tool



The tool **Pixel Counter Color** counts the pixels in a specified color range within the tool's region of interest.



NOTE

This tool can only be used together with color variants of picoCam2 or midiCam2.



NOTE

If the object position varies between the acquired images, this tool must be linked to a locator tool. Tools which are linked to a locator tool are repositioned according to the position of the located object. Drag and drop a created tool onto an added locator tool to link them.

Settings

Setting	Description
Color	Only include pixels that have a color value within the specified range. <ul style="list-style-type: none"> • Color (h): Specify a color (hue) value and a tolerance. The selected range is shown on top of the color gradient. • Saturation (s): Specify the saturation (saturation) range. • Brightness (v): Specify the brightness (value) range.

Regions

This tool operates within its region of interest (ROI), which is set in the **Regions** section in the tool pane. For more information about how to set the ROI, see "[Setting the region of interest for a tool](#)", page 45.

Results

Result	Description	Variable name
Coverage	The percentage of pixels within the specified Color range, in relation to the total number of pixels in the tool's region of interest.	Coverage
Number of pixels	The number of pixels within the specified Color range in the tool's region of interest.	NumPixels
Pass decision	Total result, based on the set threshold values for Coverage .	Pass

6.7.1.21 Region tool



The **Region** tool defines a region of interest within the image area. The defined region of interest can be referenced by the **Image Collection** tool and **AI Classification** tool for deep learning applications where only a specific part of each acquired image is relevant for the image classification.

Settings

Use the **Regions** list to set the region of interest (ROI) for the **Region** tool. Each region in the list is defined as positive or negative. The total ROI is defined as the union of all the positive regions subtracted by the union of all the negative regions. To change the size and position of a region, click and drag its handles in the image viewer.

Results

Result	Description	Variable name
Pass decision	A Pass result means that the set ROI is valid. A Fail result means that the set ROI is invalid, or that the connected Object Locator tool is invalid or did not find a match.	Pass

6.7.2 Results tools

The **Results** category contains settings and tools for result processing and output handling.

Click or Drag and drop tools from the tool box (to the left of the tool tree) to the **Results** category to add them to the tool tree. Click a tool in the tool tree to display its tool pane, which contains tool settings and results.

6.7.2.1 Expression tool



The **Expression** tool is used for creating an expression, based on mathematical and logical operations. The expression is evaluated and the result value is updated for each new image. The data type of the result value is evaluated each time the expression is changed.

The **Expression** tool result can be used by other tools:

- If the expression returns a boolean value, the **Digital Output** tool can use the result value for setting the signal levels of the digital outputs. A true value corresponds to signal level HIGH, and a false value corresponds to signal level LOW.
- The **Send String** tool can send the result value as a string to external devices.



NOTE

Hoover over the text or heading of a tool, parameter, or list data to see the ID linked to the item you want to use.

Settings

Setting	Description
Expression	<p>Create an expression by inserting any combination of the following elements:</p> <ul style="list-style-type: none"> • Mathematical operators • Logical operators • Mathematical functions • Constants • List functions • General functions • General variables related to the image acquisition and the tool output <p>See the "References" section for a list of available elements.</p>

The **Add** list contains the available results for the current job. See the tool help pages for descriptions of the tool results and corresponding variable names.

Results

Result	Description
Value	The result value, based on the expression created in the Settings section. The result value is updated for each new image. The result value may be a boolean or real number. The data type is evaluated each time the expression is changed.

Examples**Return the first height element returned by get**

Expression:

```
at(get(result("CompletenessCheck3D:0", "Cells"), "height"), 0)
```

Result type:

number

Return the first height element returned by get using first

Expression:

```
first(get(result("CompletenessCheck3D:0", "Cells"), "height"))
```

Result type:

number

Return the first characters returned by slice

Expression:

```
slice("abcd", 0, 2)
```

Result type:

string

Return a subList with the characters located in the second and third position by using slice

```
slice(List("a", "b", "c", "d"), 1, 2)
```

Result type:

string+

Return a list of Point3D

```
List(Point(1,2,3), Point(4,5,6), Point(7,8,9))
```

Result type:

Point3D+

Insert a tool result in an expression

Use the following syntax to insert a tool result in an expression:

```
result("<tool id>", "<result name>")
```

The name of each tool instance is displayed in the tool pane. Hover over the tool name to see the tool id, for example, "PixelCounter:1".

Create an expression that is true if the Blob Counter tool finds more than two blobs

Expression:

```
result("BlobCounter:0", "NumBlobs") >= 2
```

Result value/Result type:

true/boolean

Return number of blobs if Blob Counter tool passes, otherwise return -1

Expression:

```
if(result("BlobCounter:0", "Pass"), result("BlobCounter:0",
"NumBlobs"), -1)
```

Check that the average coverage of two Pixel Counter tools is greater than 50%

Expression:

```
((result("PixelCounter:0", "Coverage") + result("PixelCounter:1",
"Coverage"))/2) > 50.0
```

Result value/Result type:

false/boolean

Get the maximum value from two Pixel Counter tools

Expression:

```
max(result("PixelCounter:0", "Coverage"), result("PixelCounter:1",
"Coverage"))
```

Result value/Result type:

0.78/number

Check if the number of found blobs is even (dividable by two)

Expression:

```
fmod(result("BlobCounter:0", "NumBlobs"), 2) == 0
```

Result value/Result type:

true/boolean

Get width of all found blobs

Expression:

```
get(result("BlobCounter:0", "Blobs"), "width")
```

Result:

A list of widths of all found blobs.

Get the x-coordinate value from a Point

Expression:

```
getX(result("FixedPoint:0", "Point"))
```

Result value/Result type:

250.3/number

Get the x-coordinate value from the start point of a Line

Expression:

```
getX(getLineStartPoint(result("LineFitter:0", "Line")))
```

Result value/Result type:

51.838/number

Output activation depending on AI Classification (dStudio) class name or index

To activate an output depending on the resulting **AI Classification (dStudio)** class name or index, **Expression** tools are needed. When the **Expression** tool is created it will be visible and usable in the dropdown list under **Result** in the **Digital Output** tool.

One **Expression** tool needs to be created for each class name. It is also possible to evaluate multiple classes in one expression hence activate the same output with several classes.

The expression below evaluates if the class name result from the **AI Classification (dStudio)** tool is "Up" or not:

```
result("AIClassificationDstudio:0", "Class")==="Up"
```

The expression below evaluates if the class name result from the **AI Classification (dStudio)** tool is "Up" or "Down":

```
(result("AIClassificationDstudio:0", "Class")==="Up") or  
(result("AIClassificationDstudio:0", "Class")==="Down")
```

When the expression below is used as **Result** for the **AI Classification (dStudio)** tool, a digital output signal is activated for each image that has class index 1.

Expression:

```
result("AIClassificationDstudio:0", "ClassIndex")==1
```

Result value/Result type:

true/boolean



NOTE

Output activation also works together with AI Classification. The tool is referenced with `AIClassification`. The class name is referenced with `ClassName` and class index is referenced with `ClassIndex`.

Reference

The **Expression** tool supports a set of operators and functions for result handling. See the tables below for details.

Table 6: Mathematical operators

Operator	Result type	Description
^	NUM	Exponentiation
/	NUM	Division
*	NUM	Multiplication
+	NUM	Addition
-	NUM	Subtraction

Table 7: Logical operators

Operator	Result type	Description
>	BOOL	Larger than
>=	BOOL	Larger than or equal to
<	BOOL	Smaller than
<=	BOOL	Smaller than or equal to
==	BOOL	Equal to
!=	BOOL	Not equal to
and	BOOL	Logical and
or	BOOL	Logical or
not	BOOL	Logical not of a boolean x

Table 8: Mathematical functions

Function	Result type	Description
abs(x)	NUM	Returns the absolute value of x
acos(x)	NUM	Returns the arccosine of x in radians.
asin(x)	NUM	Returns the arcsine of x in radians.
atan(x)	NUM	Returns the arctangent of x in radians.
atan2(y, x)	NUM	Returns the arctangent of y/x (in radians), but uses the signs of both parameters to find the quadrant of the result.
ceil(x)	NUM	Rounds x up to the nearest integer.
cos(x)	NUM	Returns the cosine of x in radians.
cosh(x)	NUM	Returns the hyperbolic cosine of x in radians.
deg(x)	NUM	Converts radians to degrees.
exp(x)	NUM	Returns e to the power of x (e ^x).
floor(x)	NUM	Rounds x down to the nearest integer.
fmod(x, y)	NUM	Returns x modulo y.
getLineEndPoint(a)	Point2D	Returns the end x- and y-coordinate value of the line a.
getLineStartPoint(a)	Point2D	Returns the start x- and y-coordinate value of the line a.
getX(a)	NUM	Returns the x-coordinate value of a.
getY(a)	NUM	Returns the y-coordinate value of a.
if(<condition>, <ifTrue>, <ifFalse>)	Dynamic	Returns the result of the clause that is run. The <ifTrue> and <ifFalse> clauses must evaluate to the same type .
log(x)	NUM	Returns the natural logarithm of x.
log10(x)	NUM	Returns the logarithm of x (base 10).
max(a,b)	NUM	Returns the maximum value of a and b.
min(a,b)	NUM	Returns the minimum value of a and b.
pow(x, y)	NUM	Returns x to the power of y (x ^y).
rad(x)	NUM	Converts degrees to radians.
sin(x)	NUM	Returns the sine of x in radians.
sinh(x)	NUM	Returns the hyperbolic sine of x in radians.
sqrt(x)	NUM	Returns the square root of x.
tan(x)	NUM	Returns the tangent of x in radians.
tanh(x)	NUM	Returns the hyperbolic tangent of x in radians.

Table 9: Mathematical constants

Constant	Result type	Description
pi	NUM	Returns the value of pi.
true	BOOL	
false	BOOL	

Table 10: List functions

Function	Result type	Description
List(a, b, ..z)	<Type of the list>+	Returns a list.

Function	Result type	Description
<code>size(list)</code>	NUM	Returns the number of items of a list.
<code>first(list)</code>	Type of the list	Returns the first element of the list.
<code>last(list)</code>	Type of the list	Returns the last element of the list.
<code>at(list, index)</code>	Type of the list	Returns the element at a given index from a list.
<code>slice(list, from, to)</code>	<Type of the list>+	Returns a portion of a list from an index to another index.

Table 11: General functions

Variable	Result type	Description
<code>Point(x, y)</code>	Point2D	Returns a Point2D.
<code>Point(x, y, z)</code>	Point3D	Returns a Point3D.
<code>slice(string, from, to)</code>	String	Returns a portion of a string from an index to another index.

Table 12: General variables

Variable	Result type	Description
<code>ImageNumber</code>	NUM	Returns the image number for the currently acquired image.
<code>OverallResult</code>	BOOL	Returns the overall result, based on the tool results for the applied Analysis tools.

6.7.2.2 Result String tool



The **Result String** tool is used for creating a text string, based on the available tool results. The created string can be used by the communication tools that support sending strings to external devices.



NOTE

Hoover over the text or heading of a tool, parameter, or list data to see the ID linked to the item you want to use.

Settings

Setting	Description
String formatter	<p>Create an output string by inserting any combination of the following options into the String formatter:</p> <ul style="list-style-type: none"> Tool result: Select an option from the list and click Add. The result is inserted at the end of the current string. Static text: Write the text directly in the String formatter. Line break: Type <code>\n</code>. Char function: The <code>\char()</code> takes one integer between 0-127 as an argument and converts it into a character using ASCII code. <p>The resulting output string is displayed as the Output string in the Results section.</p>
Number of decimals	Select the number of decimals to display in the output string for results of number type.
Boolean representation	Select how to format boolean values in the output string.

The **Add** list contains the available results for the current job. See the tool help pages for descriptions of the tool results and corresponding variable names.

Results

Result	Description
Output string	The output string, based on the text string created in the String formatter in the Settings section. The Output string is updated for each new image.

Output format

When creating the output string, the included tool results are converted to string format according to the table below:

Tool result type	Format	Example
string	The string value.	"Hello"
int	Value converted to string.	"234"
bool	Value converted to string.	"true"
float	Value converted to string, with the number of decimals according to the Number of decimals setting.	"245.56"
Plane	"nx,ny,nz,d", which are the plane parameters in Hesse normal form.	"0.27,0.53,0.80,4.00"
Point	"x,y" with the number of decimals according to the Number of decimals setting.	"16.45,43.98"
Shape_LineSegment	"x1,y1,x2,y2", where the values correspond to the x- and y-coordinates of the endpoints on the line segment. Number of decimals according to the Number of decimals setting.	"16.76,201.83,89.02,45.09"

Examples

Examples of formatted strings and the corresponding output strings are shown below.

Format a test string

String Formatter:

```
Hello World
```

Corresponding output string:

```
Hello World
```

Format a test string with a line break

String Formatter:

```
Hello \nWorld
```

Corresponding output string:

```
Hello
```

```
World
```

Format a string which includes the image number

String Formatter:

```
Image number: \n\ImageNumber()
```

Corresponding output string:

```
Image number:
```

```
83
```

Format a string which includes the number of blobs from the Blob Counter tool

String Formatter:

```
Number of blobs: \n\nresult("BlobCounter:0", "NumBlobs")
```

Corresponding output string:

```
Number of blobs:
4.00
```

Format a string which includes the result and the coverage for the Pixel Counter tool

String Formatter:

```
{\result("PixelCounter:0", "Pass");\result("PixelCounter:0",
"Coverage")}
```

Corresponding output string:

```
{false;82.12}
```

Format a string which includes a result that does not exist

String Formatter:

```
\result("BlobCounter:0", "InvalidResultName")
```

Information shown in the Issues panel:

```
Tool BlobCounter:0 has no result named InvalidResultName
```

Format a string which includes a tool that does not exist

String Formatter:

```
\result("InvalidTool:0", "Result")
```

Information shown in the Issues panel:

```
Tool InvalidTool:0 is not found
```

6.7.3 Communication tools

The **Communication** category contains tools for sending results to external devices.

Click or Drag and drop tools from the tool box (to the left of the tool tree) to the **Communication** category to add them to the tool tree. Click a tool in the tool tree to display its tool pane, which contains tool settings.

6.7.3.1 Digital Output tool



The **Digital Output** tool sends tool results to the device's digital outputs.

Click the **Digital Output** tool instance to view a list of available output ports and edit the associated settings.

To configure additional ports as outputs, use the **I/O Configuration** tool on the **System** page.



NOTE

The digital outputs are only active in **Run** mode.



NOTE

An **I/O Configuration** tool instance must be added before the **Digital Output** tool can be used. The ports that are set as **OUT/Digital output** by the **I/O Configuration** tool are available in the **Digital Output** tool.

Settings

The following settings are available for each digital output port:

Setting	Description
Enabled	Activate the port for output signals.

Setting	Description
Result	<p>Select a result which will activate the output signal. The Logic level setting in I/O Configuration controls if the signal is Active high or Active low. The Result list contains the following options:</p> <ul style="list-style-type: none"> • Result ready: All analyses are done and a result is available gives output signal activated. • All passed: A pass result for all Analysis tool instances gives output signal activated. • Any fail: An output with this result is activated if any tool in the job fails. • All Expression tool instances where the output is a boolean value: A True result for the selected tool instance gives output signal activated. • All Analysis tool instances: A pass result for the selected tool instance gives output signal activated.
Deactivate after	<p>Deactivate the output signal after a defined time duration (pulse length).</p> <p>If the Deactivate after checkbox is not selected, the output signal will remain activated until a new result is available.</p>

The **State** indicator displays the current status based on the **Result**. For example: If **Result** is set to **All passed** and all tools Pass decision are true, the **State** indicator turns green.

Output activation depending on AI Classification (dStudio) class name

In order to activate an output depending on the resulting **AI Classification (dStudio)** class name, **Expression** tools are needed. For more information, see ["Expression tool"](#), page 85.

6.7.3.2 EtherNet/IP tool



The tool **EtherNet/IP** sends and receives two 128-byte streams to a connected PLC using the EtherNet/IP™ standard. The type-structure and data content of each position is editable.

Settings

The tool **EtherNet/IP** requires that EtherNet/IP is enabled on the device. To enable EtherNet/IP:

1. Go to **Configure** mode.
2. Set the **System/Jobs** switch to **System**.
3. In the Systems tool tree, click **Fieldbus**.
4. In the **Mode** list, select **EtherNet/IP**.
5. Click **Apply and reboot** to restart the device and apply the updated settings.

If **EtherNet/IP** is selected and **Apply and reboot** is inactive, it means that EtherNet/IP is already enabled on the device.

The **Status** of the control bits is shown in the **Settings** section. Their function is described in a mouseover tooltip.

The **Assembly size (bytes)** shows the maximum size for a byte stream.

Bit	Control bits in (to PLC)	Control bits out (from PLC)
0	Reserved	Trigger
1	Reserved	Change job
2	Result ready	Change reference image
3	OK	Reserved
4	Reserved	Reserved

Bit	Control bits in (to PLC)	Control bits out (from PLC)
5	Error	Reserved

When the analyses are done, the **Result ready** signal bit will go high. The time this signal should remain active is set in the **Result ready deactivation time** text field. If the deactivation time is longer than the image acquisition cycle time, the signal will not go low between results.

The **Result ready** bit is bit number 2 in the response control bits. For more information regarding the response control bits, see "[Command Channel tool](#)", page 49.

Result mapping

The **Result mapping** section displays the configuration to send to the PLC. Data types ending with square brackets are array types, and can be used to send list results and string type results.

Data type	Size	Range	Result
SINT	1 byte	[-128, 127]	Number, boolean
INT	2 bytes	[-32 768, 32 767]	Number, boolean
DINT	4 bytes	$[-2^{31}, 2^{31}-1]$	Number, boolean
REAL	4 bytes		Number, boolean
SINT[]	1 byte per array slot	[-128, 127]	String, List
INT[]	2 bytes per array slot	[-32 768, 32 767]	List
DINT[]	4 bytes per array slot		List
CHAR[]	1 byte per array slot	[0, 255]	String
WCHAR[]	2 bytes per array slot	[0, 65 535]	String

All data types are according to the IEC EN 61131-3 standard.



NOTE

Not all data types that are available here are available on all PLCs. Select data types available for your PLC.

The byte number for each result is shown in the **Byte** column. When the device is in **Run** mode, the last sent value is shown in the **Value** column.

Adding a result:

1. Select a type suitable to the result you want to send using the drop-down list **Data type**.
2. Select the result using the drop-down list **Result**.



NOTE

Data types are always added in block of even multiples of 4 bytes. If SINT is added, a block of 4 is added. Each slot in the block can be assigned its own result.

Removing a result:

1. Select **Remove** from the drop-down list **Data type** for the result you want to remove.

If a float number is inserted into an integer data type, the number is rounded down before sending it to the PLC. Boolean values are represented as integers, where 1 = true, 0 = false.

**NOTICE**

When inserting tool results into the configuration, make sure that the results are assigned the correct data type. If a result value is outside the available range for the assigned data type, the data type maximum will be sent instead.

For example: If a result of 200 is attempted to be sent on a SINT position, 127 will be sent instead.

If you are using a Rockwell PLC, click the link [Download UDT for Rockwell PLCs](#) to download a User Data Type (UDT) of this configuration, which simplifies the data handling on the PLC side.

Command mapping

The **Command mapping** section displays the settings that the PLC can change on the camera. Data types ending with square brackets are array types, and can be used to modify string and enum type parameters.

Data type	Size	Range	Parameter
SINT	1 byte	[-128, 127]	Number, boolean
INT	2 bytes	[-32 768, 32 767]	Number, boolean
DINT	4 bytes	$[-2^{31}, 2^{31}-1]$	Number, boolean
REAL	4 bytes		Number, boolean
SINT[]	1 byte per array slot	[-128, 127]	String, enum
CHAR[]	1 byte per array slot	[0, 255]	String, enum
WCHAR[]	2 bytes per array slot	[0, 65 535]	String, enum

All data types are according to the IEC EN 61131-3 standard.

**NOTE**

Not all data types that are available here are available on all PLCs. Select data types available for your PLC.

The byte number for each result is shown in the **Byte** column. When the device is in **Run** mode, the last sent value is shown in the **Value** column, and errors in the **Error code** column. 0 means no error.

Adding a parameter:

1. Select a type suitable to the parameter you want to be able to modify using the drop-down list **Data type**.
2. Select the tool using the drop-down list **Tool**.
3. The field **Instance** allows you to specify one or multiple tools to modify. If only a single tool should be modified, enter the instance number. If multiple tool instances should be changed at the same time, it is possible to specify ranges using the "-" operator, for example: 0-3 for instance 0, 1, 2 and 3. It is also possible to use the "," separator, for example: 0-1,3 for instance 0, 1 and 3.
4. Select the parameter using the drop-down list **Parameter**.
5. Certain parameters have more than one value associated with them, for example ranges which have a minimum and maximum value. Select which sub-parameter to edit in the drop-down list **Sub-parameter**.

**NOTE**

Data types are always added in block of even multiples of 4 bytes. If SINT is added, a block of 4 is added. Each slot in the block can be assigned its own result.

Removing a parameter:

1. Select **Remove** from the drop-down list **Data type** for the result you want to remove.

Boolean values are represented as integers, where 1 = true, 0 = false.

If you are using a Rockwell PLC, click the link [Download UDT for Rockwell PLCs](#) to download a User Data Type (UDT) of this configuration, which simplifies the data handling on the PLC side.

6.7.3.3 Image Collection tool



The **Image Collection** tool is used to save acquired images to an FTP server or an SD card (if it is supported by the device). Saving images to an FTP server takes longer time. The saved images can be used for playback, or by the dStudio software for training a Deep Learning network. The tool should be used during the collection phase. The tool should not be used default when going live since it will reduce performance.

The **Image Collection** tool makes it possible to append information such as image number and result variables to the filename of each image, to facilitate the labeling that is required for the training of the network.

Settings

Setting	Description
Collection mode	Select the target medium to which to save the acquired images. Different devices support different collection modes. The mode Disk is only available when running on SICK AppEngine. SD card is not available when running on SICK AppEngine.
File type	Select the file type for the images, png or bmp.
FTP server IP address	Enter the IP address of the FTP server. The plugin assumes that you are using port 21. This option is only applicable if Collection mode is set to FTP .
FTP server port	Enter any port between 1 and 65535. This option is only applicable if Collection mode is set to FTP .
FTP username	Enter the username to use for authentication towards the FTP server. This option is only applicable if Collection mode is set to FTP .
FTP password	Enter the password for authentication towards the FTP server. This option is only applicable if Collection mode is set to FTP .
Disk file path	This option is only visible when running on SICK AppEngine, and is the path where the images are saved. By default, Disk file path is left empty. The default path, SICK AppEngine's public folder, is used. This folder is found by opening File Explorer and searching for %AppData% in the address bar, and press Enter. <ul style="list-style-type: none"> This will navigate you to <code>../AppData/Roaming</code>. Go one step back to <code>../AppData</code> and navigate into <code>../AppData/Local/SICK/SICK AppEngine/appdata/public</code>. The folder can also be found in AppManager in the tab "AppData". If a path is specified, the images will be saved at the specified location. A new folder called <code>nova</code> is created at the current file path if it does not exist, and should not be included in the file path. Examples of what a file path can look like: <code>/C:/</code> , <code>C:/</code> and <code>C:</code> Entering <code>C:/</code> in Disk file path will save the images at <code>C:/nova</code> . This option is only applicable if Collection mode is set to Disk .

Setting	Description
Sort into job folder	Sort each saved image into a sub-directory on the target medium, based on which job that was active when the image was saved. When a job is active and the first image is saved, the corresponding sub-directory is created.
Append instance to filename	Append the name of the Image Collection tool instance to the filename of each acquired image. This option is recommended when more than one Image Collection tool instance is used, to avoid that images with identical filenames are overwritten.
Append power-on count to filename	Append the number of device resets to the filename of each saved image. The number of device resets is the total count since the device was produced.
Append image number to filename	Append the image number to the filename of each saved image. The image number is 1 for the first acquired image and increases by 1 for each image acquisition. The image number resets after each device reboot.
Append string result to filename	Append a string result, produced by a referenced tool, to the filename of each saved image. Examples: <ul style="list-style-type: none"> Use a Result String tool instance to parse the image analysis output and then reference the tool instance to append the result string to the filename of the image. Use a Result String tool instance to add free text in order to pre-classify the image.
Save image during Configure	Save the acquired images in Configure mode, to allow the user to test the settings before entering Run mode. When running on SICK AppEngine this setting is activated by default since Run mode is not available when running on an emulator. For other devices, default is still to not save during Configure . Selecting this checkbox will only save images when in Configure mode. Save image during Configure does only affect Configure mode. If an Image Collection tool is added to a configuration, images will always be saved in Run mode. To stop saving images in Run mode, the Image Collection tool needs to be removed from the configuration.
Image downsample factor	The downsample factor for the saved images, compared to the acquired images. The downsample factor is applied both vertically and horizontally. For example, a downsample factor of 2 will resize a 1000 x 1000 px image into a 500 x 500 px image. Downsampling is recommended to save disk space and to decrease the processing time for images with high resolution.
Region reference	Crop each acquired image. The outer boundaries of the cropping area are defined by a referenced Region tool. Cropping is recommended for images that have a lot of variance and noise that is not useful for image classification. Notes: <ul style="list-style-type: none"> Only positive rectangular regions can be used for cropping. If the referenced Region tool contains more than one region, the first positive rectangular region in the list is used. If the Region tool does not contain any positive rectangular regions, an error message appears. If the referenced region is empty or invalid, no cropping is applied to the image and the full image is saved. If the position and rotation of the object of interest vary between the acquired images, link the connected Region tool to an Object Locator tool. See the Object Locator tool help for more information.

Setting	Description
Save condition	<p>From the dropdown menu:</p> <ul style="list-style-type: none"> • Select Always to save the image, regardless of tool result. • Select a boolean tool result to save the image only if that result is true. <p>Tool results can be combined as expressions. See the Expression tool help for more information.</p>

Results

Result	Description	Variable name
Filename	The filename to be assigned to the currently displayed image when it is saved.	Filename
Image information	<p>The image resolution and estimated file size for the acquired image.</p> <p>The Image information result helps the user estimate the number of images that can be stored on the target medium. The file size estimation is updated if the parameters related to the image resolution are changed.</p>	ImageSize

6.7.3.4 PROFINET tool



The tool **PROFINET** sends a 128-byte stream to a connected PLC using the PROFINET standard. The type-structure and data content of each position is editable.

Settings

The tool **PROFINET** requires that PROFINET is enabled on the device. To enable PROFINET:

1. Go to **Configure** mode.
2. Set the **System/Jobs** switch to **System**.
3. In the Systems tool tree, click **Fieldbus**.
4. In the **Mode** list, select **PROFINET**.
5. Click **Apply and reboot** to restart the device and apply the updated settings.

If **PROFINET** is selected and **Apply and reboot** is inactive, it means that PROFINET is already enabled on the device.

The **Status** of the control bits is shown in the **Settings** section. Their function is described in a mouseover tooltip.

Bit	Control bits in (to PLC)	Control bits out (from PLC)
0	Reserved	Trigger
1	Reserved	Change job
2	Result ready	Change reference image
3	OK	Reserved
4	Reserved	Reserved
5	Error	Reserved



NOTE

The bits are seen as two individual bytes. If they are seen as a single word, the byte order is swapped due to endianness.

When the analyses are done, the **Result ready** signal bit will go high. The time this signal should remain active is set in the **Result ready deactivation time** text field. If the deactivation time is longer than the image acquisition cycle time, the signal will not go low between results.

The **Result ready** bit is bit number 2 in the response control bits. For more information regarding the response control bits, see ["Command Channel tool"](#), page 49.

Result mapping

The **Result mapping** section displays the configuration to send to the PLC. Data types ending with square brackets are array types, and can be used to send list results and string type results.

Data type	Size	Range	Result
SINT	1 byte	[-128, 127]	Number, boolean
INT	2 bytes	[-32 768, 32 767]	Number, boolean
DINT	4 bytes	$[-2^{31}, 2^{31}-1]$	Number, boolean
REAL	4 bytes		Number, boolean
SINT[]	1 byte per array slot	[-128, 127]	String, List
INT[]	2 bytes per array slot	[-32 768, 32 767]	List
DINT[]	4 bytes per array slot		List
CHAR[]	1 byte per array slot	[0, 255]	String
WCHAR[]	2 bytes per array slot	[0, 65 535]	String

All data types are according to the IEC EN 61131-3 standard.



NOTE

Not all data types that are available here are available on all PLCs. Select data types available for your PLC.

The byte number for each result is shown in the **Byte** column. When the device is in **Run** mode, the last sent value is shown in the **Value** column.

Adding a result:

1. Select a type suitable to the result you want to send using the drop-down list **Data type**.
2. Select the result using the drop-down list **Result**.



NOTE

Data types are always added in block of even multiples of 4 bytes. If SINT is added, a block of 4 is added. Each slot in the block can be assigned its own result.

Removing a result:

1. Select **Remove** from the drop-down list **Data type** for the result you want to remove.

If a float number is inserted into an integer data type, the number is rounded down before sending it to the PLC. Boolean values are represented as integers, where 1 = true, 0 = false.



NOTICE

When inserting tool results into the configuration, make sure that the results are assigned the correct data type. If a result value is outside the available range for the assigned data type, the data type maximum will be sent instead.

For example: If a result of 200 is attempted to be sent on a SINT position, 127 will be sent instead.

If you are using a Siemens PLC, it is possible to click the link [Download UDT for Siemens PLCs](#) or [Download FB for Siemens PLCs](#) to download a User Data Type (UDT) or Function Block (FB) of this configuration, which simplifies the data handling on the PLC side.

Command mapping

The **Command mapping** section displays the settings that the PLC can change on the camera. Data types ending with square brackets are array types, and can be used to modify string and enum type parameters.

Data type	Size	Range	Parameter
SINT	1 byte	[-128, 127]	Number, boolean
INT	2 bytes	[-32 768, 32 767]	Number, boolean
DINT	4 bytes	$[-2^{31}, 2^{31}-1]$	Number, boolean
REAL	4 bytes		Number, boolean
SINT[]	1 byte per array slot	[-128, 127]	String, enum
CHAR[]	1 byte per array slot	[0, 255]	String, enum
WCHAR[]	2 bytes per array slot	[0, 65 535]	String, enum

All data types are according to the IEC EN 61131-3 standard.



NOTE

Not all data types that are available here are available on all PLCs. Select data types available for your PLC.

The byte number for each result is shown in the **Byte** column. When the device is in **Run** mode, the last sent value is shown in the **Value** column, and errors in the **Error code** column. 0 means no error.

Adding a parameter:

1. Select a type suitable to the parameter you want to be able to modify using the drop-down list **Data type**.
2. Select the tool using the drop-down list **Tool**.
3. The field **Instance** allows you to specify one or multiple tools to modify. If only a single tool should be modified, enter the instance number. If multiple tool instances should be changed at the same time, it is possible to specify ranges using the “-” operator, for example: 0-3 for instance 0, 1, 2 and 3. It is also possible to use the “,” separator, for example: 0-1,3 for instance 0, 1 and 3.
4. Select the parameter using the drop-down list **Parameter**.
5. Certain parameters have more than one value associated with them, for example ranges which have a minimum and maximum value. Select which sub-parameter to edit in the drop-down list **Sub-parameter**.



NOTE

Data types are always added in block of even multiples of 4 bytes. If SINT is added, a block of 4 is added. Each slot in the block can be assigned its own result.

Removing a parameter:

1. Select **Remove** from the drop-down list **Data type** for the result you want to remove.

Boolean values are represented as integers, where 1 = true, 0 = false.

If you are using a Siemens PLC, it is possible to click the link [Download UDT for Siemens PLCs](#) or [Download FB for Siemens PLCs](#) to download a User Data Type (UDT) or Function Block (FB) of this configuration, which simplifies the data handling on the PLC side.

6.7.3.5 Send String tool



The **Send String** tool sends text results from tools to an external device. When the system is in **Run** mode, a text string is sent to the external device for each new image.

Settings

Setting	Description
Interface	The ID of the interface tool that connects to the external device. All TCP Client and TCP Server tool instances in the System tool tree can be used.
Result	The tool instance that creates the text string to send as output.

6.8 Run mode

Run is the default mode for the SensorApp. Use **Run** mode for inspection of objects in a real environment, based on the configuration created in **Configure** mode.

In **Run** mode, images are acquired continuously or by an external trigger. All acquired images are analyzed. To decrease the processing time, only some of the acquired images are displayed in the viewer in the user interface.



NOTE

When the system is in **Run** mode:

- The communication interfaces are active and communicate with the connected external devices.
- No changes to the tool tree or tool settings are possible.
- To switch jobs, click the job list in the job handling section in the user interface or use a **Job Selection I/O** tool or **Command Channel** tool via **TCP/IP** or **Fieldbus** to switch jobs via digital inputs (see "[Interfaces tools](#)", page 48).

6.9 License handling

The license handling procedure is available directly from the application. Open the **System** tab and select **Licensing**.

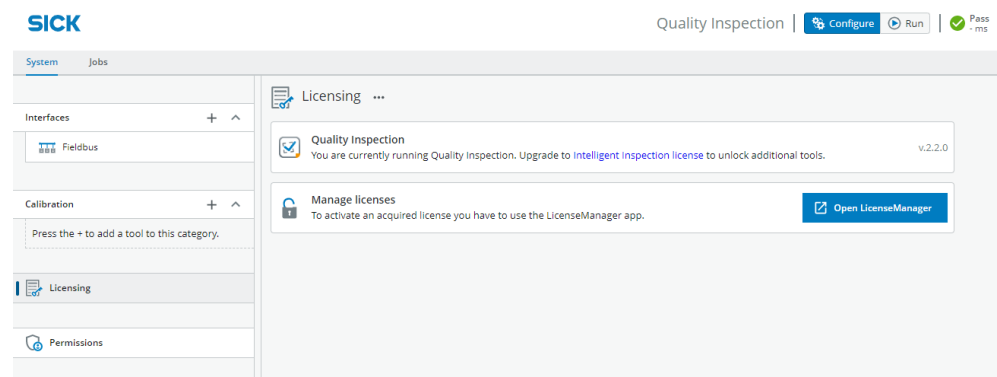

Figure 20: Activate a license from the application

The active toolset is shown on the **Licensing** page. If **Quality Inspection** is active, a link to the product page for **Intelligent Inspection** is shown. You can go directly to the **LicenseManager**, by clicking the button **Open LicenseManager**.

SICK LicenseManager is a SensorApp for the management of licenses on SICK App-Space-programmable devices. It provides an overview of active licenses and supports the user in the activation and deactivation of licenses.

6.9.1 Indicating the need of a license

Different indicators show the need of a license in the tool pane, tool tree, and in the tool box menu.

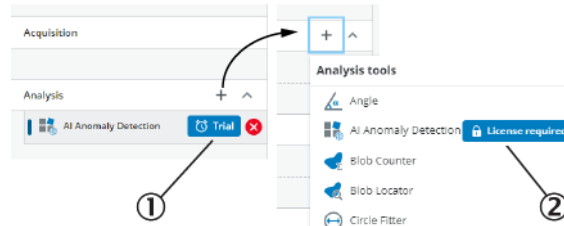

Figure 21: Indicators showing different ways to indicate the need of a license

- ① Trial mode indicator
- ② License required indicator

Indicator	Description
License required	Indicates that the tool cannot be used without a license.
Trial	Indicates that the tool can be used, but within a limited time. The Trial indicator is shown even after the trial period has ended.

If there is no active license for a tool found on the device, **License required** is shown in the tool pane. The information differs depending on if the tool has a trial period or not.

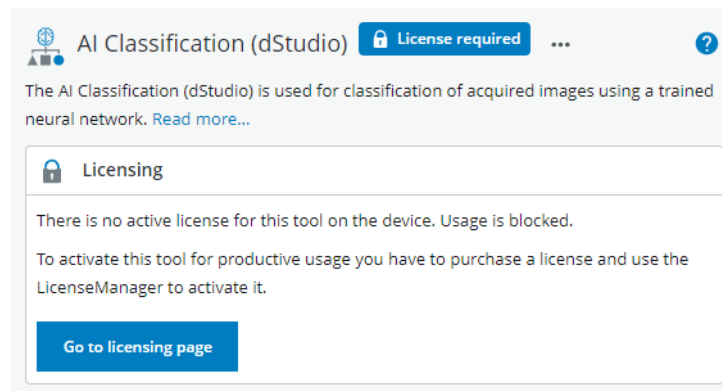

Figure 22: Indicating the need of a license in the tool pane

Trial mode

Trial period of 2-hours per reboot for the Intelligent Inspection toolset without Intelligent Inspection License activated. When working with the tool **AI Classification (dStudio)**, use dStudio to create and download a trial classification network (<https://dstudio.cloud.sick.com/>).

Production mode

The Intelligent Inspection Upgrade License makes it possible to productively use the tools contained in the Intelligent Inspection toolset, when installed on certain SICK products. When working with the tool **AI Classification (dStudio)**, the productive classification network is downloaded via dStudio.

6.9.2 Activation of Intelligent Inspection Upgrade License

On a physical device:

1. Open the **System** tab and select **Licensing**.
2. Do you have a license ticket?
 - a) Yes. Proceed to step 3.
 - b) No. Click the link to Intelligent Inspection license, for more information about the features. Purchase a license and you will receive a ticket via email. When you have the license ticket, proceed to step 3.
3. Click the button **Open LicenseManager** and follow the instructions.

On SICK AppEngine:

- The **Intelligent Inspection Upgrade License** is activated directly in the cloud.
- License handling procedure is described in the getting started guide for SICK AppEngine, and is found on the supportportal.sick.com.

Further topics

- [Activating a license using LicenseManager](#)

7 Annex

7.1 Third party licenses

SICK uses open source software which is published by the rights holders under a free license. Among others, the following license types are used: GNU General Public License (GPL version 2, GPL version 3), GNU Lesser General Public License (LGPL), MIT license, zlib license and licenses derived from the BSD license.

This program is provided for general use without warranty of any kind. This warranty disclaimer also extends to the implicit assurance of marketability or suitability of the program for a particular purpose.

More details can be found in the GNU General Public License.

For license texts see www.sick.com/licensetexts.

License texts can be read out from the device using a web browser via the following URL: <device ip>/license/COPYING

Printed copies of the license texts are also available on request.

7.2 Standard plug-in tools

The following standard plug-in tools are available for download. For information about installation process, see [see "Installing tools", page 30](#).

7.2.1 Analysis tools

7.2.1.1 1D Code DPM tool



The **1D Code DPM** tool reads one 1D bar code. One instance of the tool can only read one code. If several codes should be read, several instances of the tool must be created.

Settings

Setting	Description
Code type	One 1D bar code type can be selected for reading. Create several tool instances if several code types need to be decoded. The Auto setting decodes all available bar code types except Pharmacode .

Results

Result	Description	Variable name
Number of codes	The number of read codes.	NumCodes
Code quality	The overall print quality of the code. The grade can be between 0 and 4. 0 is the lowest and 4 is the highest grade.	CodeQuality
Code length	The length of the read code.	CodeLength
Code orientation	The orientation of the read code.	CodeOrientation
Module width in pixels	The module width in pixels of the read code.	ModuleWidth
Code content	The content of the read code.	CodeContent
Code type	The recognized code type of the read code.	FoundCodeType
Pass decision	The total result, based on the set threshold values.	Pass

7.2.1.2 2D Code DPM tool



The **2D Code DPM** tool reads one 2D data code. One instance of the tool can only read one code. If several codes should be read, several instances of the tool must be created.

Settings

Setting	Description
Code type	One 2D code type can be selected for reading. Create several tool instances if several code types need to be decoded.
Decoder setting	<p>The Decoder setting defines if the read operation should be time-optimized or if it is more important to adopt an aggressive decoding approach.</p> <ul style="list-style-type: none"> • Fast decoding is recommended if the code is of high quality and it is important to achieve a short decoding time. • The Aggressive option should be selected when the decoding time is less relevant. Example: when reading a stationary object, but the code is of lower quality (e.g., low levels of contrast or when the code contains an error). • The Balanced option accommodates applications that fall between the two extremes. • Teach with reference image uses the reference image of the job to train the decoder. A taught decoder can lead to a very short decoding time. The decoder does not read codes that differ in size, polarity, quality, or contrast compared to the code in the reference image. Note that the teaching of the decoder is performed at the first execution of the tool after choosing this option, rebooting the device, or switching the job.
Timeout (ms)	The decoder aborts after a defined time in milliseconds. A maximum cycle time can be ensured by using the timeout. Setting the timeout to zero deactivates the timeout. There may be jitter of up to 10 ms.

Results

Result	Description	Variable name
Number of codes	The number of read codes.	NumCodes
Code quality	The overall print quality of the code. The grade can be between 0 and 4. 0 is the lowest and 4 is the highest grade.	CodeQuality
Code length	The length of the read code.	CodeLength
Code orientation	The orientation of the read code.	CodeOrientation
Module height in pixels	The module height in pixels of the read code.	ModuleHeight
Module width in pixels	The module width in pixels of the read code.	ModuleWidth
Code content	The content of the read code.	CodeContent
Code type	The recognized code type of the read code.	FoundCodeType
Pass decision	The total result, based on the set threshold values.	Pass

7.2.1.3 OCR tool



The tool **OCR** segments and classifies text in an image using a pre-trained font classifier. The reference position of the text is configured with a region. It is important that the region is aligned to match the orientation of the text.

Change the **Minimum contrast** until the printed text is well segmented. The segmentation result can be seen by the overlay on the image. If the text that is to be read is printed in dot print, the parameter **Is dot print** needs to be enabled under the section **Dot print segmentation**.



If the text position varies between the acquired images, it is recommended to link this tool to a locator tool. For more information, see the tool help for locator tools.

If the classified text is to be verified as corresponding to a known text, this can be done using the **Character verification** settings. If some other type of verification is needed, the tool **Expression** can also be used.



For more information, see "[Expression tool](#)", page 85.

Settings

Segmentation	Description
Polarity	The intensity of the text. Set this value to Dark on light if the text is darker than the background, and Light on dark if the text is lighter than the background.
Minimum contrast	The minimum contrast that the characters have to their surrounding background. A high value means that higher contrast is required between the light and dark sides of an edge.
Dot print segmentation	Description
Is dot print	Enable this setting if the text is printed using dot print.
Tightly spaced characters	Enable if the gap between adjacent characters is smaller than the largest gap between two dots within a single character.
Maximum dot gap	The maximum gap size between two dots within a character in pixels. Setting this parameter can significantly reduce the runtime of the tool.
Advanced segmentation settings	Description
Stroke width	The minimum and maximum stroke width of the characters in pixels. If disabled, the stroke width is detected automatically. Note that this setting only applies to characters, not to dots and other separators.
Character width	The minimum and maximum width of the characters in pixels. If disabled, the character width is detected automatically. Note that this setting only applies to characters, not to dots and other separators.
Character height	The minimum and maximum height of the characters in pixels. If disabled, the character height is detected automatically. Note that this setting only applies to characters, not to dots and other separators.
Exclude separators	Enable this setting if separators should be excluded from the segmentation. The separators that will be excluded are . , - = * : < and >.

Advanced segmentation settings	Description
<p>Text block structure</p>	<p>To simplify the search for specific structures within the segmented text, it is possible to define text block structures. For each text line the distances between the characters are calculated, and based on these distances, the text line is divided into text blocks. Short characters¹⁾ are ignored in this process and treated as spaces.</p> <p>The text block structure is written with numbers to indicate the number of characters per text block, and spaces to separate each block. For example, if the text to be found is a date written in the format 1970-01-01, the text block structure will be 4 2 2. A date that could be written either as 01-01-1970 or 01-01-70 has the text block structure 2 2 2-4. 2-4 indicates that the last character block can consist of between 2 to 4 characters.</p> <hr/> <p> NOTE Every text block structure which is found will be displayed in its entirety in the Text result, even if there are overlaps with other found text block structures. Any characters that do not match the text block structure will be excluded.</p> <p>This setting may not provide the expected result if the spacing between characters varies, or if the region covers more than one line of text.</p>
<p>Character pattern</p>	<p>A character pattern can be used to define the wanted set of characters. If the classification result with the highest confidence for each character does not match the character pattern, the algorithm tries to correct it by changing at most 3 of the characters to matching classifications with lower confidence.</p> <p>Symbols in a character pattern:</p> <ul style="list-style-type: none"> • 1 is used to symbolize a digit • A is used to symbolize an uppercase letter • a is used to symbolize a lowercase letter <p>Additionally, the characters . : - and / can be entered. * is used to indicate that any character is acceptable.</p> <p>The character pattern may contain spaces, but the spaces will not be matched and therefore have no effect. Example: a date written with two digits for the day and month, four digits for the year and using dots for separation, is described with the character pattern 11.11.1111.</p> <hr/> <p> NOTE Enabling this setting may increase the runtime. Entering any character other than the ones listed here, will result in an error.</p>

¹⁾ Examples of short characters: . : _ - /

Character selection	Description
Allowed characters	<p>Select which characters are allowed to exist in the classified text. The classifier only considers the allowed characters. By restricting the options for the classifier, a more accurate classification can be obtained.</p> <ul style="list-style-type: none"> • Select the option All when all different types of characters may appear in the text, i.e. uppercase letters, lowercase letters, digits, and special characters. Lowercase letters are not included if the parameter Is dot print is enabled. • Select the option Only digits when only digits appear in the text. • The option Digits and special characters is suitable when there are special characters and digits present in the text, but no letters. • The option Capital letters and special characters is recommended when the text consists of capital letters and special characters, but not digits or lowercase letters. • Select the option Digits and capital letters when capital letters and digits are present in the text, but not special characters or lowercase letters. <p>Special characters refer to the following list of characters: – / + . \$ % * © £ ¥</p> <p>If Is dot print is enabled, the list of special characters is: – / . : *</p>
Character verification	<p>Enable this setting to verify that the classified text corresponds to a known expected text. The Text result will be verified against this text and if they match, the result variable Verification result will be set to True, otherwise False.</p> <hr/> <p> NOTE The Verification text should only contain characters that are allowed according to the chosen option of Allowed characters. Characters that are not allowed will not appear in the Text result.</p> <p>Since the classifier does not classify spaces, any entered spaces will be ignored in the verification. However, the spaces will be displayed in the Text result if it matched the verification text.</p>
Relaxed matching	<p>Enable this setting if the verification against the Verification text should be relaxed. The verification is allowed to reclassify certain characters as other, similar looking characters.</p> <p>Substitutions enabled with this option:</p> <ul style="list-style-type: none"> • c and C • s and S • u and U • v and V • w and W • x and X • z and Z • o, O and 0 • l, I and 1 <hr/> <p> NOTE If the classified text is found to match the verification text with relaxed matching, Text result will correspond to the verification text.</p>

Regions

This tool operates within its region of interest (ROI), which is set in the **Regions** section in the tool pane. For more information about how to set the ROI, see ["Setting the region of interest for a tool"](#), page 45.

The region should be placed so it covers the text without covering too much of the background. It is important that the region is aligned to match the orientation of the text.



NOTE

This tool only supports one region. If text is to be read in several regions of the image, it is recommended to add several instances of the tool.

Visual aid

As an intermediate step in the algorithm, the characters are segmented and visualized as overlays on top of the characters in the image. If the confidence for the classification of a character is above the set threshold, the segmentation will be green. If the confidence is below the threshold, the segmentation will be red.

Every second character will have a different shade, to better enable determining that each character has been segmented correctly. Make sure to set the segmentation parameters so that each character is fully covered by green or red overlay. The characters should also be separated from the neighboring characters, showing a different shade than the characters on either side.

The result of the classification will be displayed next to the region in the image, to help determining if the segmentation has been successful. If the region covers more than one line of text, a space will be added in the resulting string to represent the line break.

Results

Result	Description	Variable name
Classification confidence	Value corresponding to the lowest confidence of any of the classified characters. All characters with a confidence score lower than the set threshold will be displayed as red in the segmentation.	ClassConfidence
Text result	The classified text. Spaces are not detected. If the region contains several rows of text, a space will be used to symbolize the line break.	TextResult
Matches character pattern	Shows True or False depending on if the classified text matches the Character pattern . If Character pattern is disabled, the result is always True .	CharPatternMatch
Verification result	Shows True or False depending on if the classified text matches the Verification text . If Verification text is disabled, the result is always True .	VerificationResult
Pass decision	The total result, based on the threshold value for Classification confidence , and the values of Matches character pattern , and Verification result .	Pass

Australia
Phone +61 (3) 9457 0600
1800 33 48 02 – tollfree
E-Mail sales@sick.com.au

Austria
Phone +43 (0) 2236 62288-0
E-Mail office@sick.at

Belgium/Luxembourg
Phone +32 (0) 2 466 55 66
E-Mail info@sick.be

Brazil
Phone +55 11 3215-4900
E-Mail comercial@sick.com.br

Canada
Phone +1 905.771.1444
E-Mail cs.canada@sick.com

Czech Republic
Phone +420 234 719 500
E-Mail sick@sick.cz

Chile
Phone +56 (2) 2274 7430
E-Mail chile@sick.com

China
Phone +86 20 2882 3600
E-Mail info.china@sick.net.cn

Denmark
Phone +45 45 82 64 00
E-Mail sick@sick.dk

Finland
Phone +358-9-25 15 800
E-Mail sick@sick.fi

France
Phone +33 1 64 62 35 00
E-Mail info@sick.fr

Germany
Phone +49 (0) 2 11 53 010
E-Mail info@sick.de

Greece
Phone +30 210 6825100
E-Mail office@sick.com.gr

Hong Kong
Phone +852 2153 6300
E-Mail ghk@sick.com.hk

Hungary
Phone +36 1 371 2680
E-Mail ertebsites@sick.hu

India
Phone +91-22-6119 8900
E-Mail info@sick-india.com

Israel
Phone +972 97110 11
E-Mail info@sick-sensors.com

Italy
Phone +39 02 27 43 41
E-Mail info@sick.it

Japan
Phone +81 3 5309 2112
E-Mail support@sick.jp

Malaysia
Phone +603-8080 7425
E-Mail enquiry.my@sick.com

Mexico
Phone +52 (472) 748 9451
E-Mail mexico@sick.com

Netherlands
Phone +31 (0) 30 204 40 00
E-Mail info@sick.nl

New Zealand
Phone +64 9 415 0459
0800 222 278 – tollfree
E-Mail sales@sick.co.nz

Norway
Phone +47 67 81 50 00
E-Mail sick@sick.no

Poland
Phone +48 22 539 41 00
E-Mail info@sick.pl

Romania
Phone +40 356-17 11 20
E-Mail office@sick.ro

Singapore
Phone +65 6744 3732
E-Mail sales.gsg@sick.com

Slovakia
Phone +421 482 901 201
E-Mail mail@sick-sk.sk

Slovenia
Phone +386 591 78849
E-Mail office@sick.si

South Africa
Phone +27 10 060 0550
E-Mail info@sickautomation.co.za

South Korea
Phone +82 2 786 6321/4
E-Mail infokorea@sick.com

Spain
Phone +34 93 480 31 00
E-Mail info@sick.es

Sweden
Phone +46 10 110 10 00
E-Mail info@sick.se

Switzerland
Phone +41 41 619 29 39
E-Mail contact@sick.ch

Taiwan
Phone +886-2-2375-6288
E-Mail sales@sick.com.tw

Thailand
Phone +66 2 645 0009
E-Mail marcom.th@sick.com

Turkey
Phone +90 (216) 528 50 00
E-Mail info@sick.com.tr

United Arab Emirates
Phone +971 (0) 4 88 65 878
E-Mail contact@sick.ae

United Kingdom
Phone +44 (0)17278 31121
E-Mail info@sick.co.uk

USA
Phone +1 800.325.7425
E-Mail info@sick.com

Vietnam
Phone +65 6744 3732
E-Mail sales.gsg@sick.com

Detailed addresses and further locations at www.sick.com