



Dsm
roofing
sheltering you
Est. 1995



Company Introduction

Welcome to OSM Roofing, a distinguished leader in the roofing industry since our establishment in 1995. Proudly based in Malaysia, OSM has consistently set the standard as a premier manufacturer of metal roofing solutions. Our commitment to excellence is reflected not only in our extensive sales and distribution network but also in our continuous investment in research and development.

At OSM Roofing, we recognize the evolving and intricate demands of our valued customers. In response, we dedicate ourselves to staying at the forefront of innovation. Through significant investments in the latest roll-forming technology, we ensure that our products are not only cutting-edge but also highly efficient and durable.

Quality is the cornerstone of our operations. OSM Roofing adheres rigorously to the ISO 9001 Quality Management System, guaranteeing that our products meet the highest industry standards. Our commitment to quality control extends across every aspect of our manufacturing process, ensuring that each roofing and cladding solution we provide is reliable, resilient, and precisely tailored to your needs.

As a customer-centric company, OSM Roofing is more than just a manufacturer; we are your trusted partner in building the future. Explore the difference that precision engineering, innovative technology, and unwavering dedication to quality can make for your roofing and cladding projects. Choose OSM Roofing for excellence that stands the test of time.





TakaiZip[®]180

Standing Seam Roof Profile

Takaizip180 – The Ultimate High-Performance Zip Roofing System

Takaizip180 is a next-generation zip system roofing designed for large-scale industrial applications. Featuring a deep pan with a 180mm rib height and 360mm effective width, it ensures superior structural strength. The machine-zipped seams create a seamless, screw-less finish, enhancing weather resistance and durability against wind and heavy rain. With a minimum pitch of just 1°, Takaizip180 offers a sleek, futuristic aesthetic while delivering exceptional performance.

Engineered for long-term reliability, Takaizip180 minimizes maintenance while maximizing protection. Its advanced interlocking system ensures a watertight solution for factories, warehouses, and commercial complexes, redefining industrial roofing with unmatched performance.

- **Deep Pan:** Superior Strength for Large Spans
- **Weatherproof:** Withstands Strong Wind & Rain
- **Futuristic Aesthetic:** Sleek & Screw-less

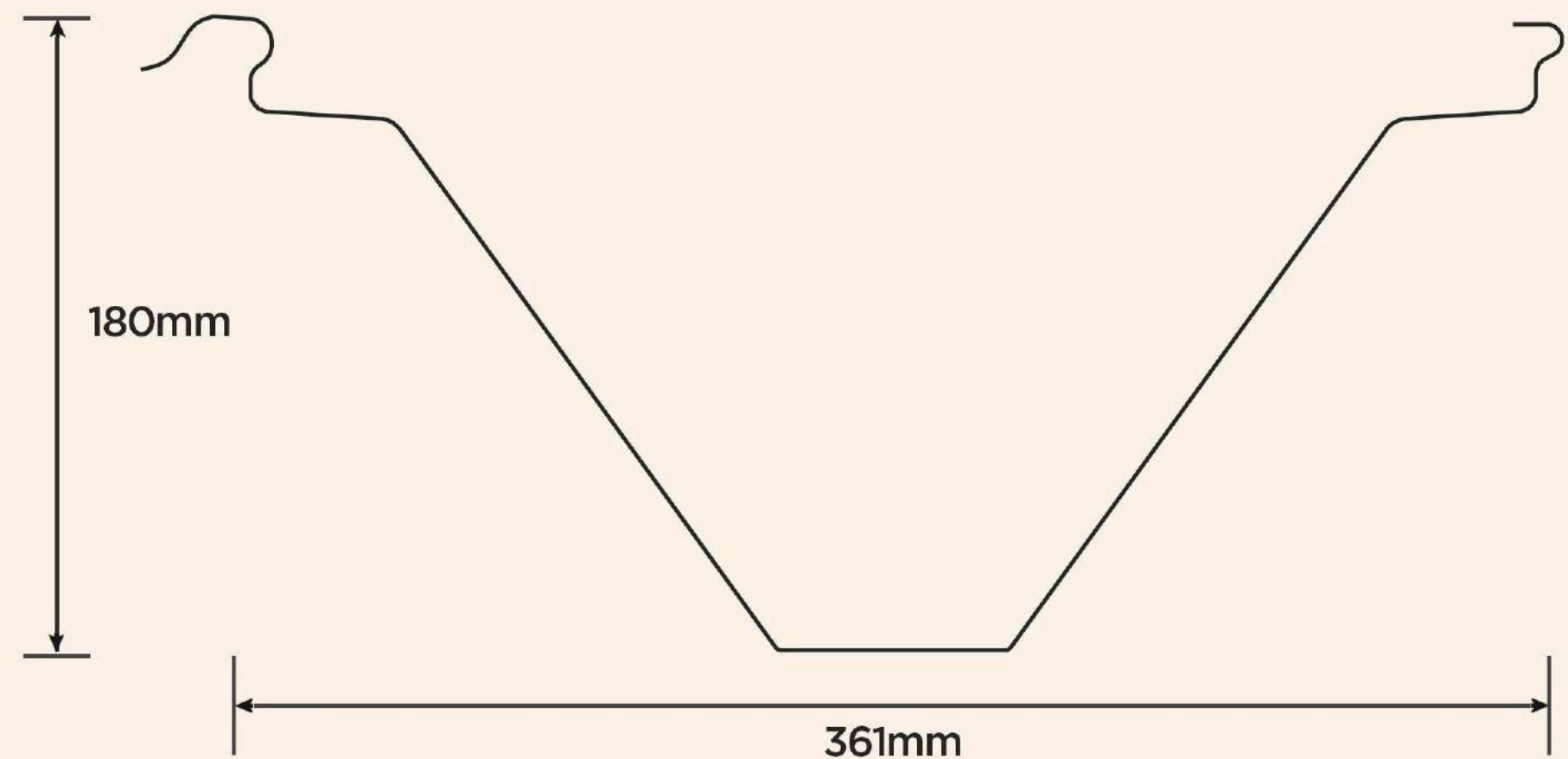
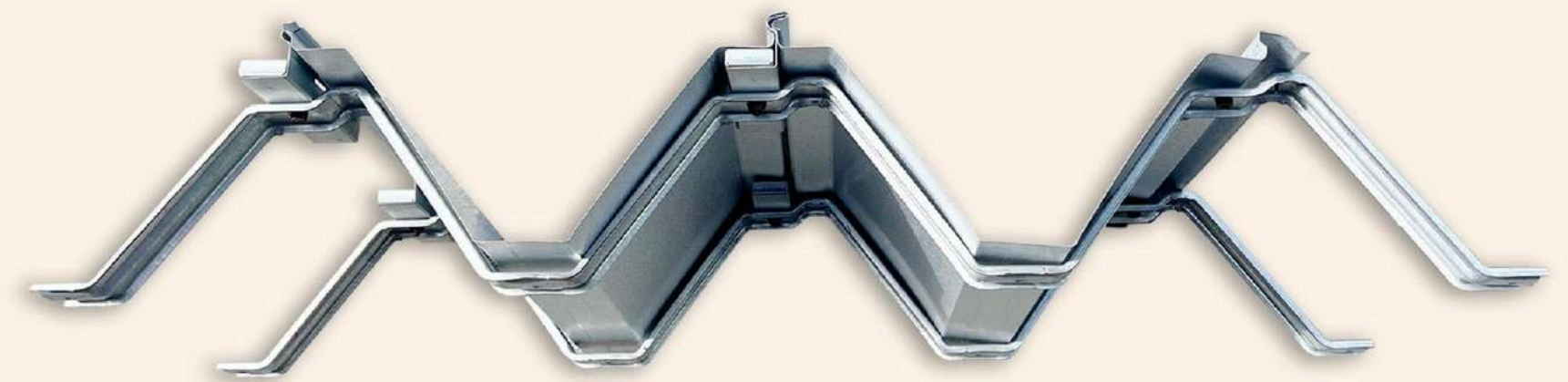
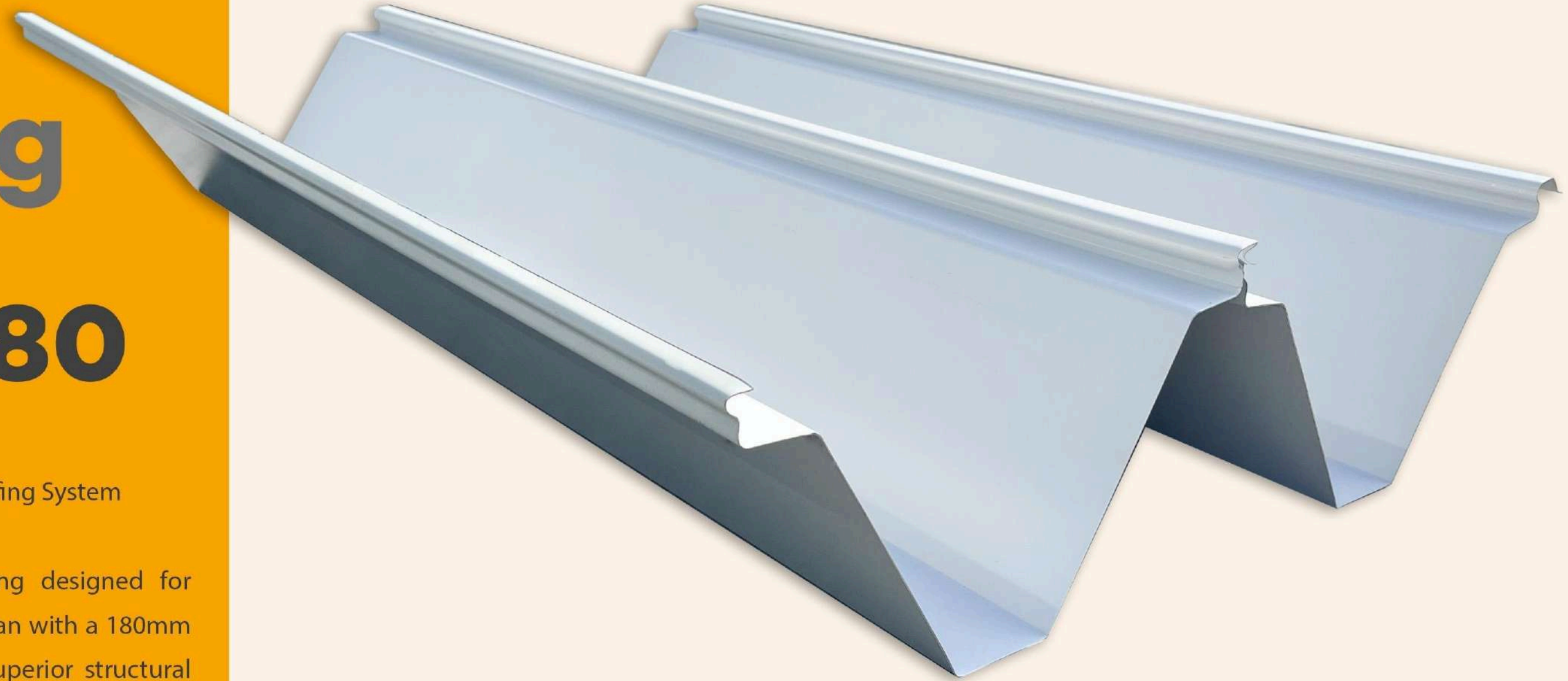

**Ultimate
High-Performance**



Quād30

Concealed screw grip & lock profile

Engineered for precision and performance, Quād30™ redefines modern roofing with its minimalist yet powerful design. Featuring two upright ribs standing 30mm tall, this system incorporates OSM's innovative Grip-and-Lock technology — a concealed fastener mechanism that ensures a clean architectural finish and superior watertightness.

The interlocking profile not only enhances aesthetic appeal but also provides outstanding structural integrity, resisting uplift and leakage even under harsh weather conditions. With its seamless joints and robust engineering, Quād30™ achieves optimal strength while maintaining a sleek, uninterrupted surface.

Designed for low-slope applications, Quād30™ performs flawlessly on roof pitches as low as 5°, making it ideal for contemporary residential and commercial projects that demand both form and function.

From design studios to large-scale developments, Quād30™ embodies OSM's commitment to innovation — delivering a roof that's stronger, smarter, and strikingly refined.

- **Innovative: Seamless & Reliable Waterproofing**
- **Enhanced Security Design: Superior Resistance**
- **Versatile Performance: High Ribs Enable Roof pitches as low as 3°**

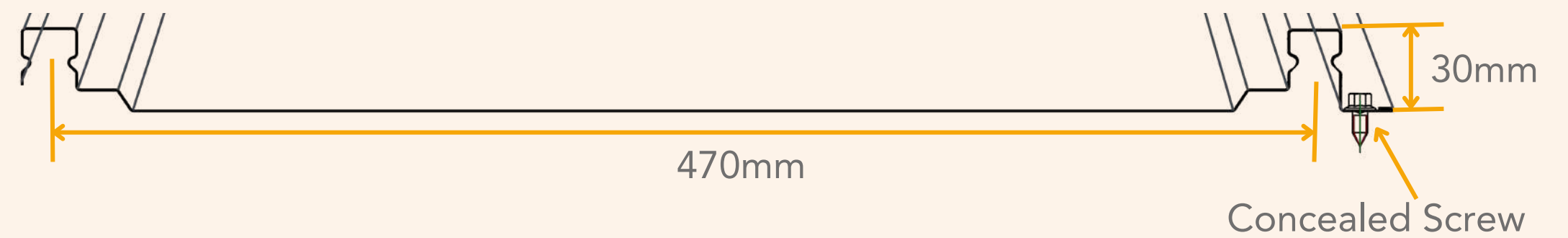
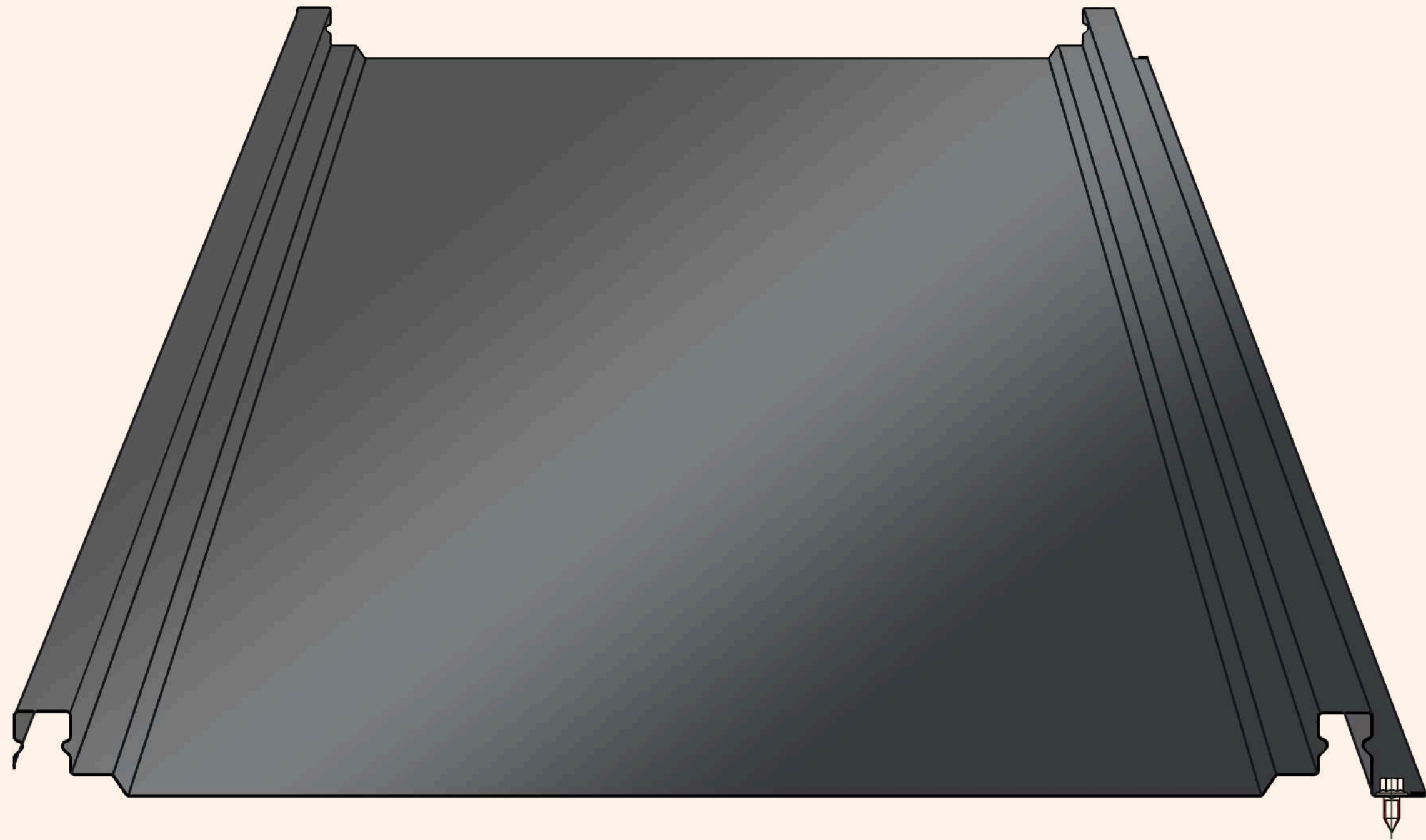



Quād30

Concealed screw grip & lock profile

Quad30 is the latest advancement in roofing systems, designed to deliver unmatched performance and reliability. This state-of-the-art solution features a concealed screw grip-and-lock mechanism that ensures a seamless and secure installation without the need for visible fasteners.

Engineered for superior strength, Quad30 is reinforced with 4 interlocking ribs, providing exceptional structural integrity while minimizing the risk of water ingress at overlaps. Its design has been rigorously tested to meet stringent performance standards, offering peace of mind against wind pressures and harsh weather conditions.

With its sleek appearance and cutting-edge functionality, Quad30 is the ideal choice for modern roofing projects that demand durability, security, and aesthetic appeal.

- **Innovative: Seamless & Reliable Waterproofing**
- **Enhanced Security Design: Superior Resistance**
- **Versatile Performance: High Ribs Enable Roof pitches as low as 3°**

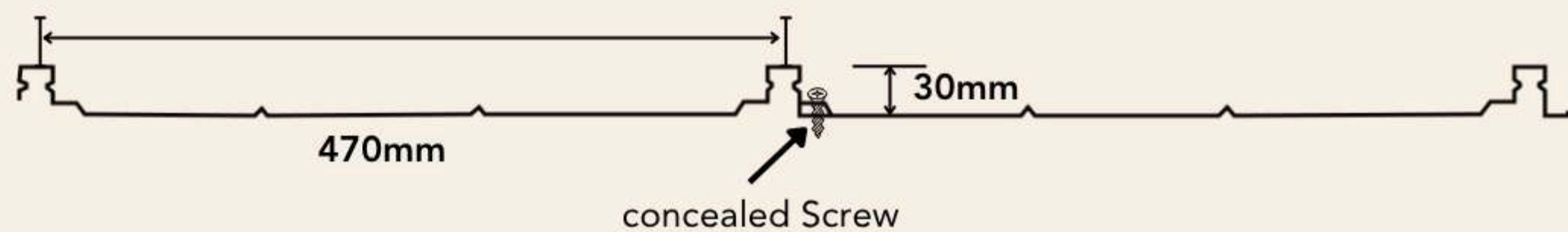
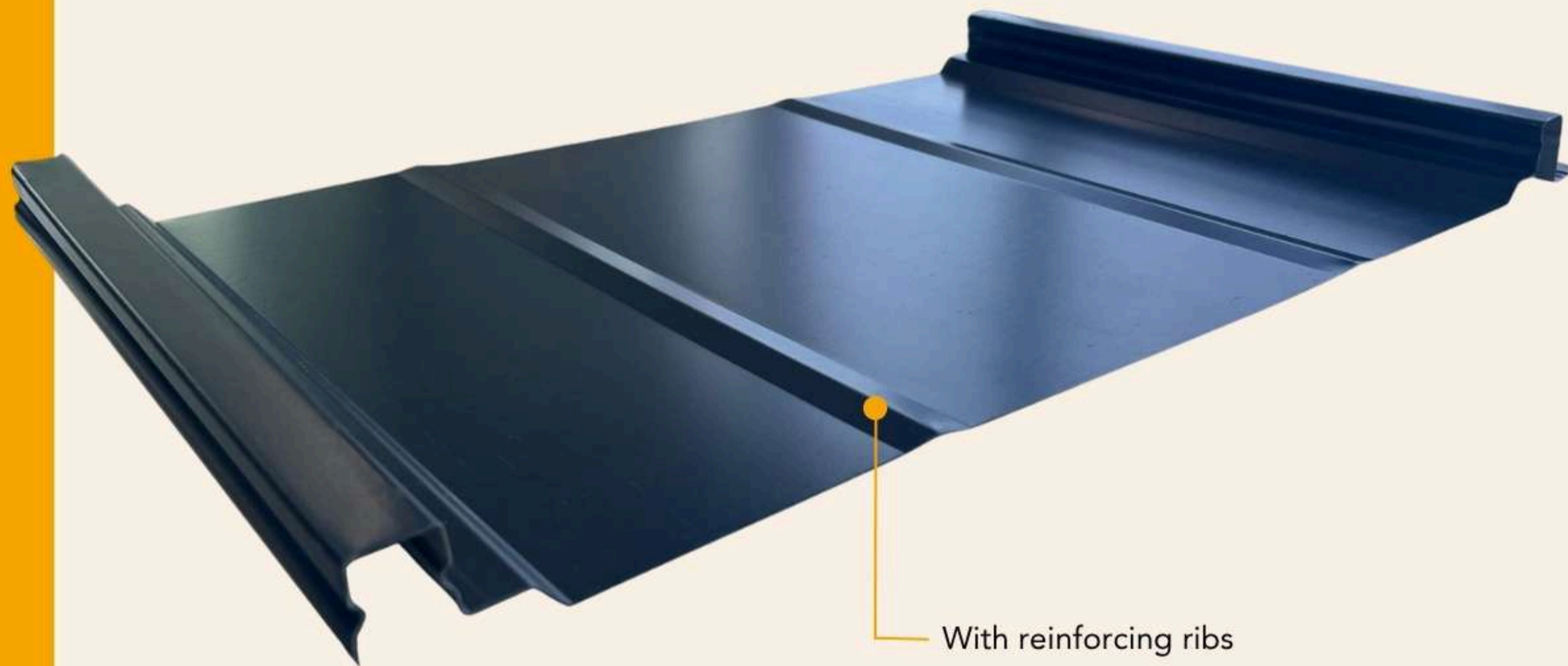



HICONDEK[®]40

Introducing Hicondek[®]40 by OSM – a revolutionary roof system that redefines installation ease. This innovative solution eliminates traditional fasteners, utilizing specially designed clips to secure the roof panel effortlessly to the roof structure. Hicondek[®]40 has successfully passed the sheet roof resistance test to wind pressure at a recommended service pressure of 4.36kPa, ensuring durability and reliability.

Featuring 4 high reinforcing ribs, this system significantly reduces the possibility of water entry from side lapping, providing enhanced protection against the elements. Hicondek[®]40 is the perfect choice for roofing design that seamlessly blends security with aesthetic appeal.

- **Powerful design eliminating fasteners**
- **Secured system prevents easy break-ins**
- **High ribs allow roof pitch to be as low as 3°**

Product Certification: CIDB PPS MS2500 : 2012
Roof Resistance Test to Wind Pressure: AS 4040.2

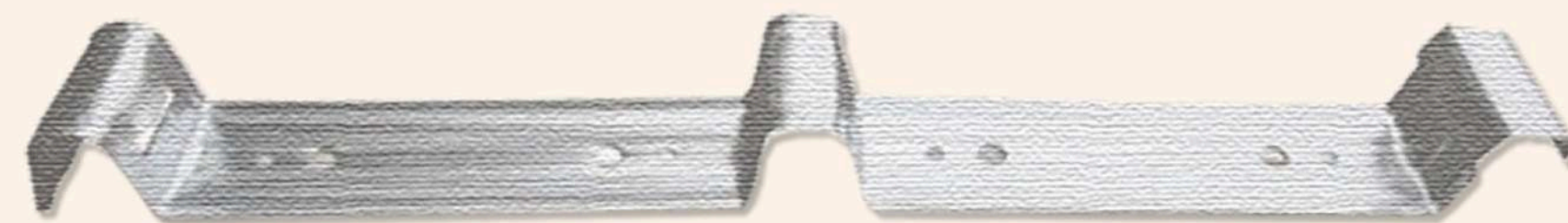

Clip Lock Profile



TWINZIP[®]25

Introducing Twinzip[®]25 – a cutting-edge full interlocking roof system with a double lock design. In this standing seam metal roof system, the edges of adjacent sheets are intricately turned up and interlocked using stainless steel clips, securely fastened to the roof supports. This unique design ensures a weather-tight unit without any exposed rivets or screws on the surface.

Unlike traditional corrugated and ribbed style roof panels, Twinzip[®]25 presents a high-end architectural standing seam design, suitable for both roof and wall cladding. With a minimum recommended pitch of 7°, this system redefines modern roofing, offering not just durability but also a sleek, seamless appearance. Upgrade your roofing experience with Twinzip[®]25 for a harmonious blend of innovation and sophistication.

- **Powerful seamless design**
- **Secured system prevents water entry**
- **Elegant & premium look on any building**



Stainless Steel Clip



Manual Crimper Tool

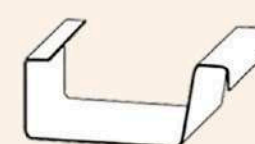

Step 1

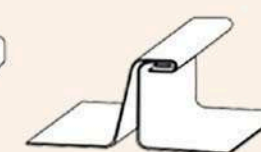

Step 2
Single Lock

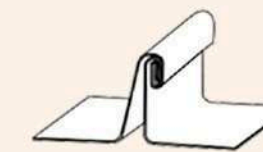

Step 3
Double Lock





TWINZIP[®]65

Introducing Twinzip[®]65 by OSM – an architectural standing seam profile that defines modern roofing. This innovative design ensures a seamless, wind, and water-tight roof without any visible external fixings. Engineered for structural integrity, Twinzip[®]65 not only provides exceptional resistance to wind uplift but also boasts outstanding aesthetic properties. Elevate your roofing experience with the perfect blend of functionality and design precision – Twinzip[®]65.

- **Powerful seamless design**
- **Secured system prevents water entry**
- **High ribs allow roof pitch to be as low as 1°**

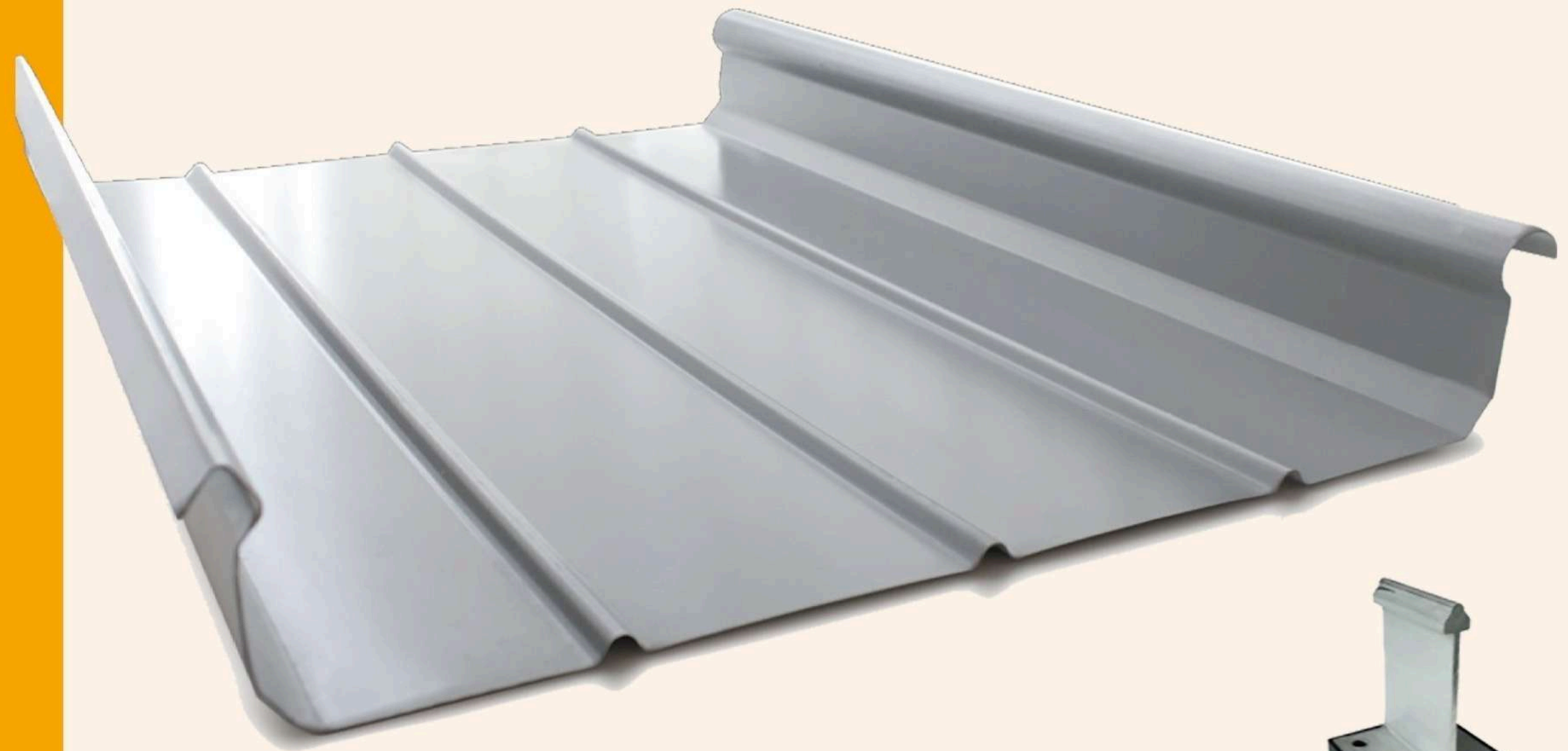

Zipper Clip System

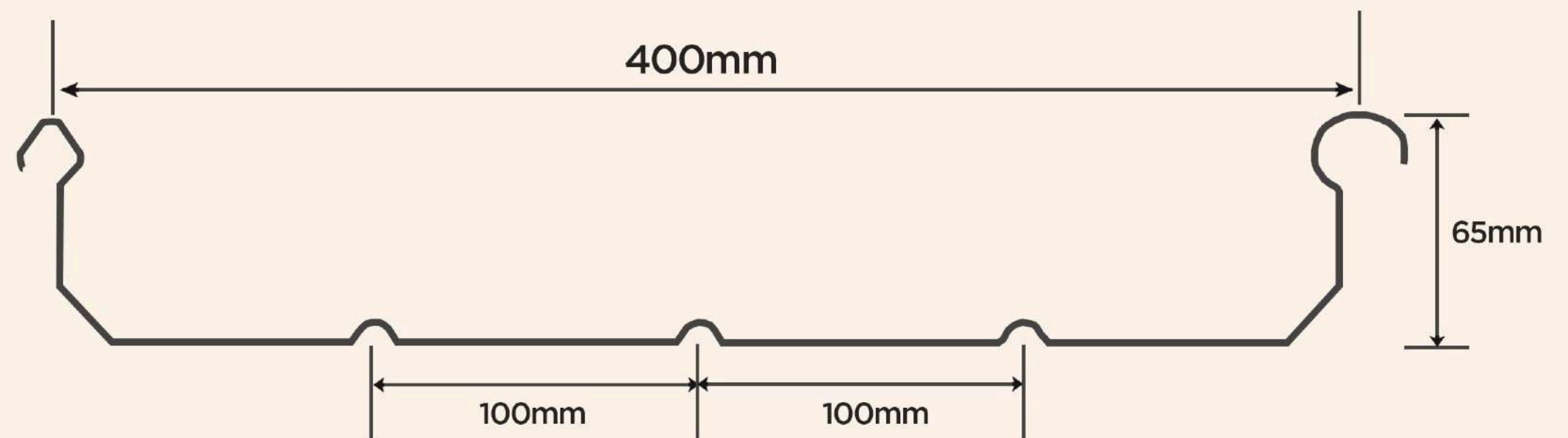



METALDEK®29

Introducing Metaldek®29 by OSM - an advanced roofing solution designed to provide exceptional durability, coverage and water resistance. The 29mm high rib is engineered to effectively prevent water seepage, ensuring watertight seal and superior protection against elements. With an effective coverage width of 740mm, the Metaldek®29 offers expansive coverage. This profile can be installed with a minimum pitch of 5°. This low pitch capabilities makes it an ideal choice for variety of roofing applications, including both steep and low-slope roofs

- **High rib design**
- **Wide effective coverage of 740mm**
- **Versatile design for both roof & cladding**

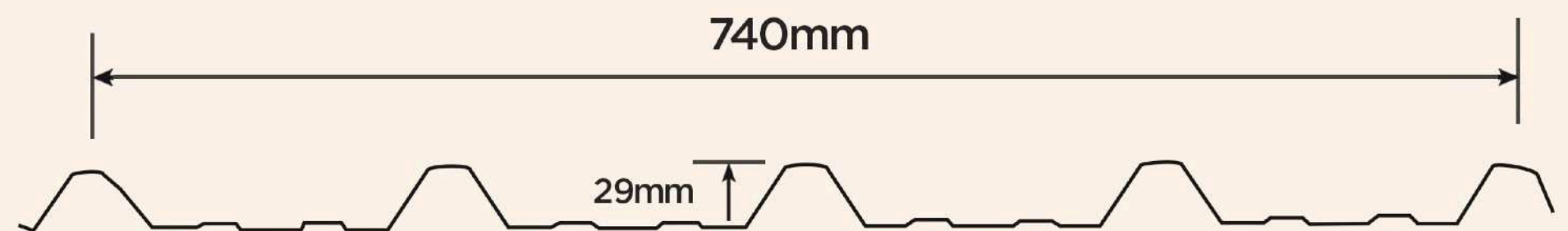
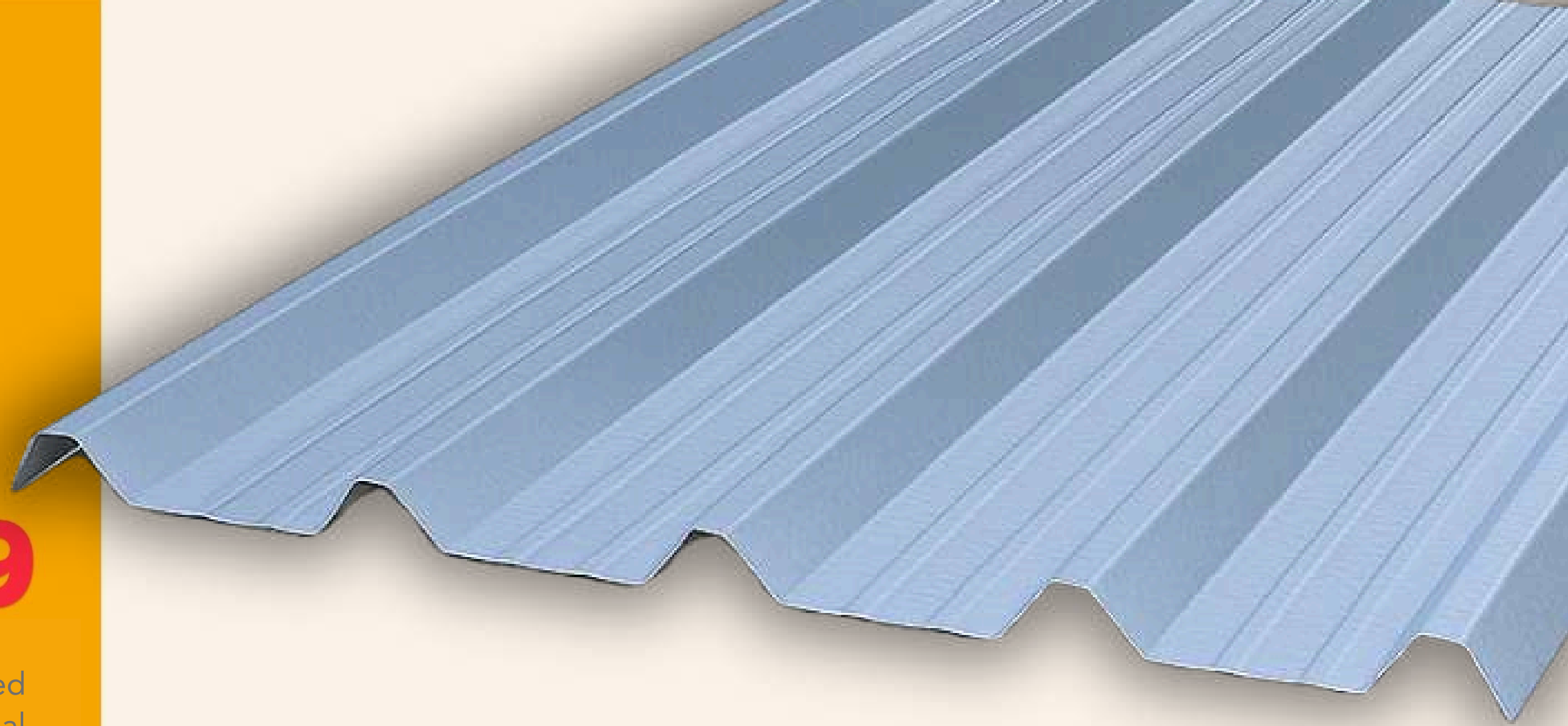



METALDEK®26

Introducing Metaldek®26 by OSM, a sleek and elevated roofing solution by OSM. Combining affordability with a modern aesthetic, Metaldek®26 is widely embraced in the market, making it an excellent choice for Roof & Wall Cladding Design. Boasting 5 high 26mm reinforcing ribs, this profile ensures minimal water entry from side lappings. The anti-capillary groove halts upward water travel, while the heightened ribs allow for a low roof pitch of 5°. Choose Metaldek®26 for a sophisticated and high-performance roofing solution that redefines style and resilience.

- **Higher rib design**
- **Wide effective coverage of 757mm**
- **Easy to handle and install**

Product Certification: CIDB PPS MS2500 : 2012

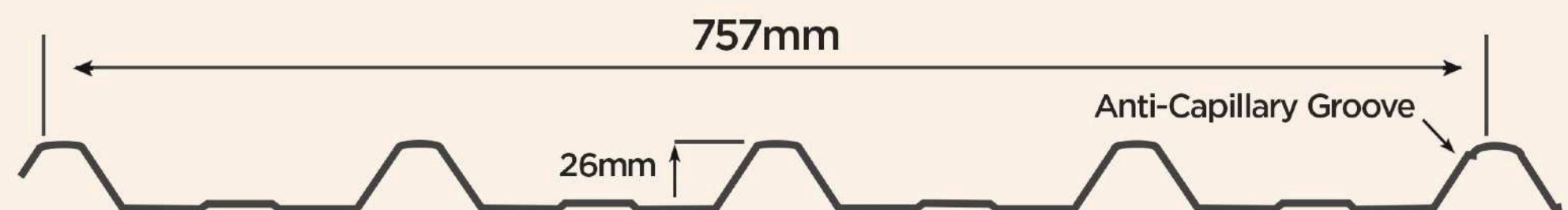
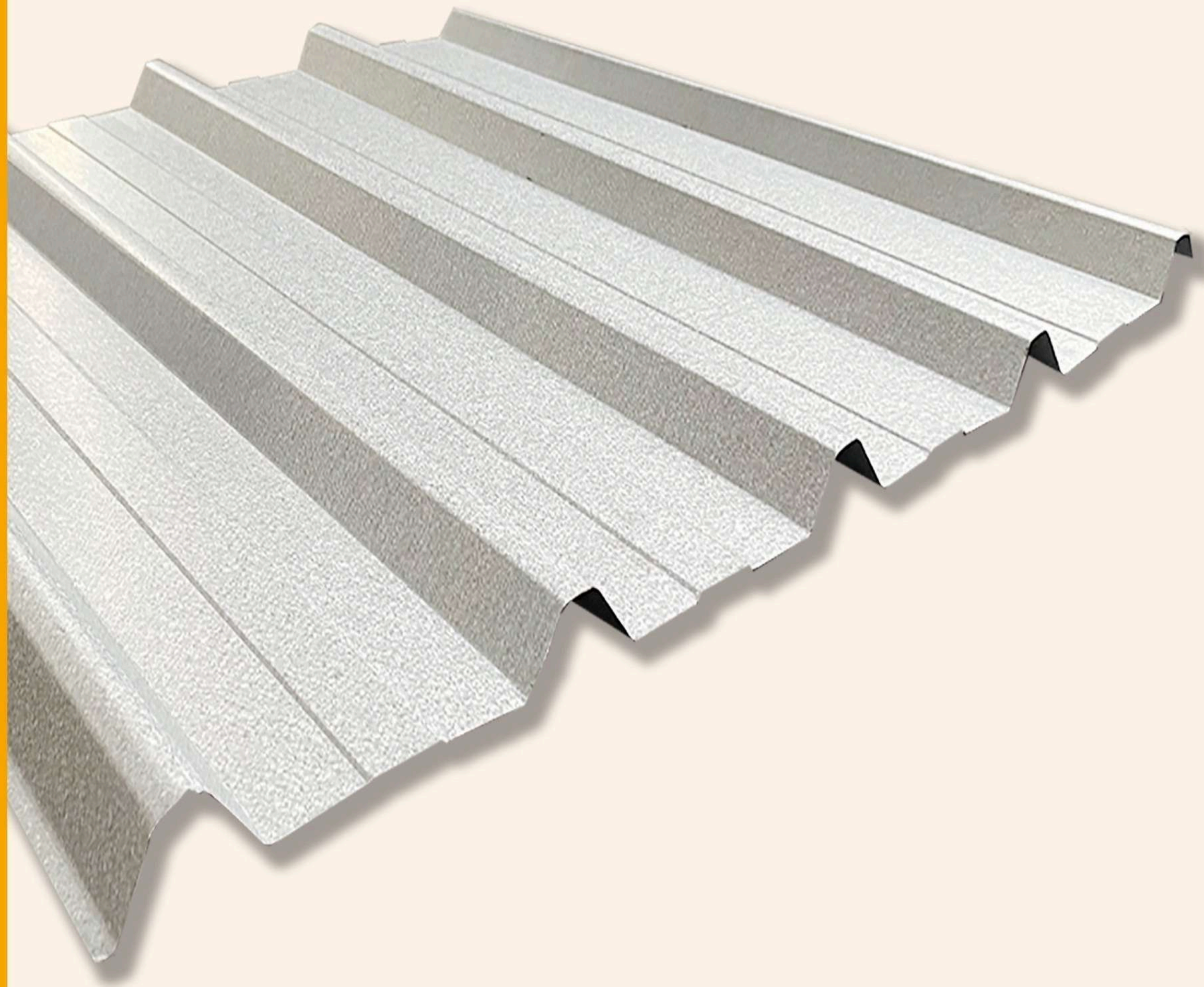



METALDEK®24

Introducing Metaldek®24 by OSM - a cost-effective and appealing roofing solution widely embraced in the market. Ideal for Roof & Wall Cladding Design, this profile features 5 high 24mm reinforcing ribs, minimizing water entry from side lappings. The anti-capillary groove prevents upward water travel, and the high ribs enable a low roof pitch of 5°. Elevate your roofing with Metaldek®24 - where affordability meets precision.

- **Strong rib design**
- **Wide effective coverage of 762mm**
- **Easy to handle and install**

Product Certification: CIDB PPS MS2500 : 2012

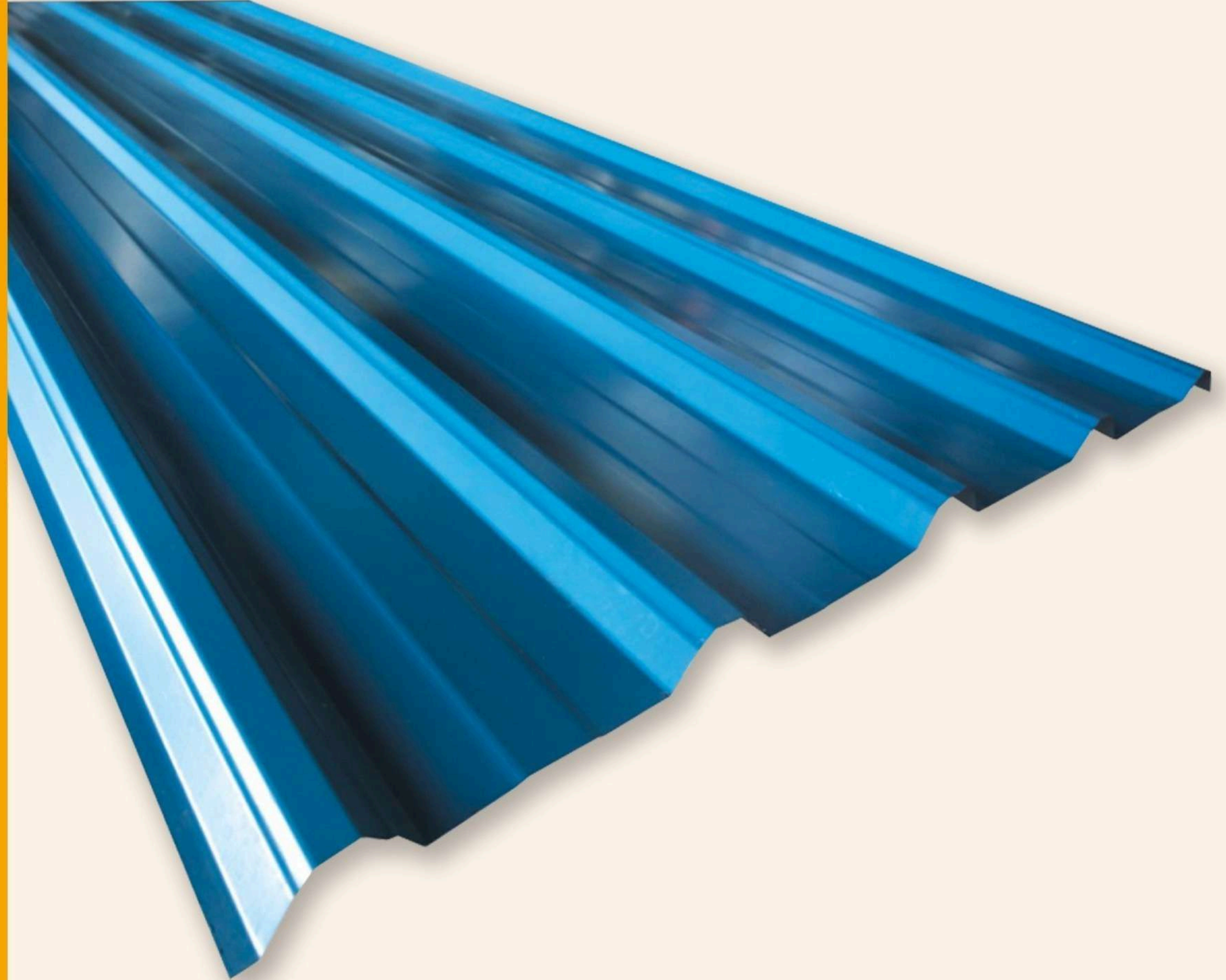



METALDEK®15

Introducing Metaldek®25 by OSM - a cost-effective and appealing walling solution widely embraced in the market. Ideal for Wall Cladding & Fascia Design, this profile features 7 high 15mm reinforcing ribs, maximising materials for cost effectiveness.

- **Wide effective coverage of 800mm**
- **Versatile design for all industrial walling**
- **Easy to handle and install**

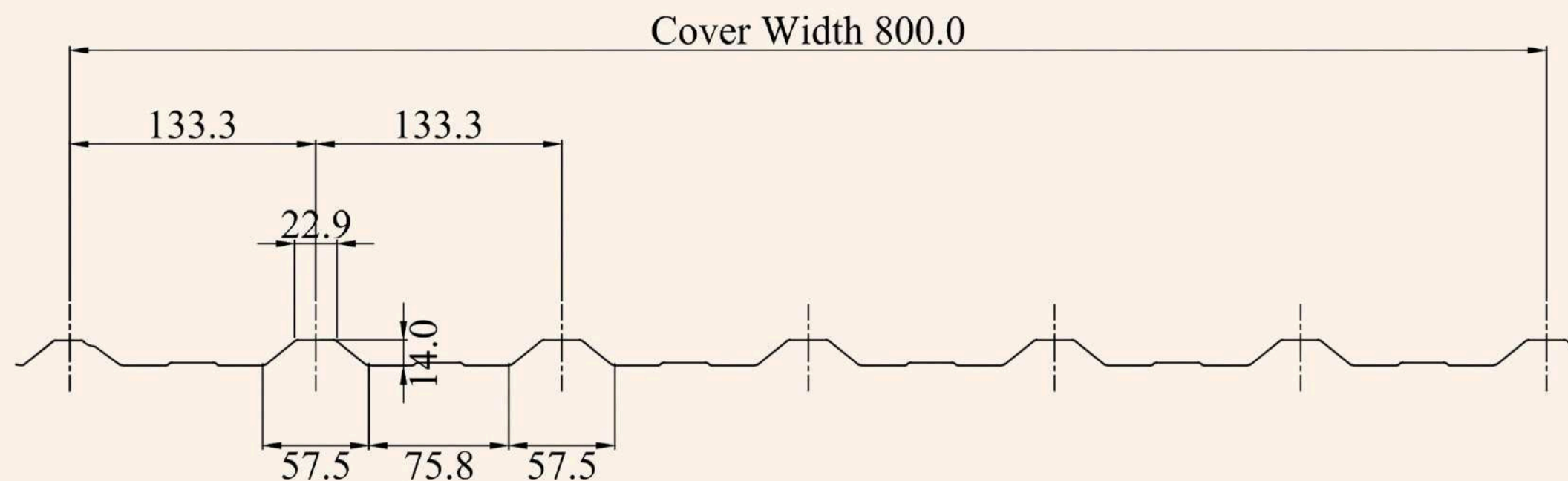
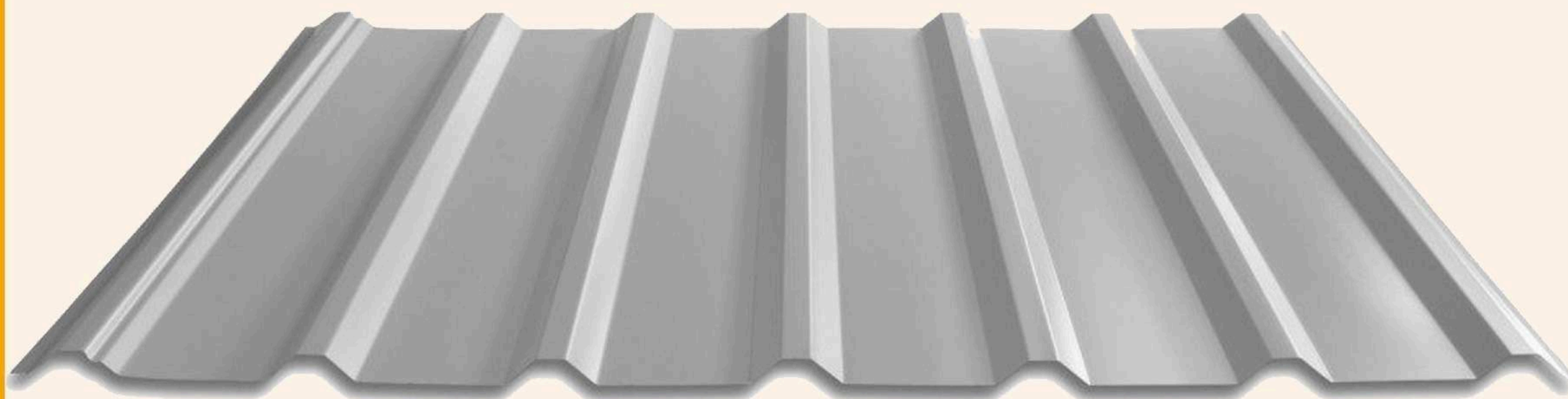



EUROTILE33

Introducing Eurotile33 by OSM - a timeless elegance of traditional tile roofs with the modern advantages of metal roofing. Designed to mimic the classic look of tile roofs, the Eurotile33 offers both aesthetic appeal and superior performance. This profile is particularly suitable for high pitched roofs, providing a striking and elegant finish to residential properties that enhances the charm of any house. The Eurotile33 can be installed with a minimum pitch of 8° making it versatile for a range of roofing applications. With an effective width of 760mm, the Eurotile33 ensures efficient coverage.

- **Classic look of traditional tiles**
- **Long life span and low maintenance**
- **Effective wide coverage**

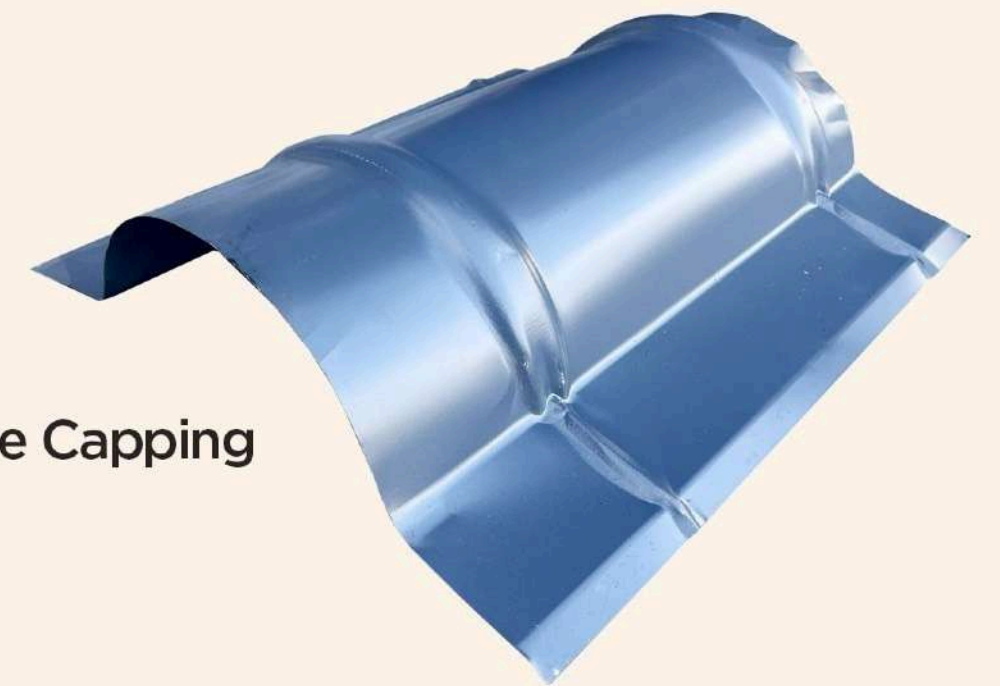

Ridge Capping

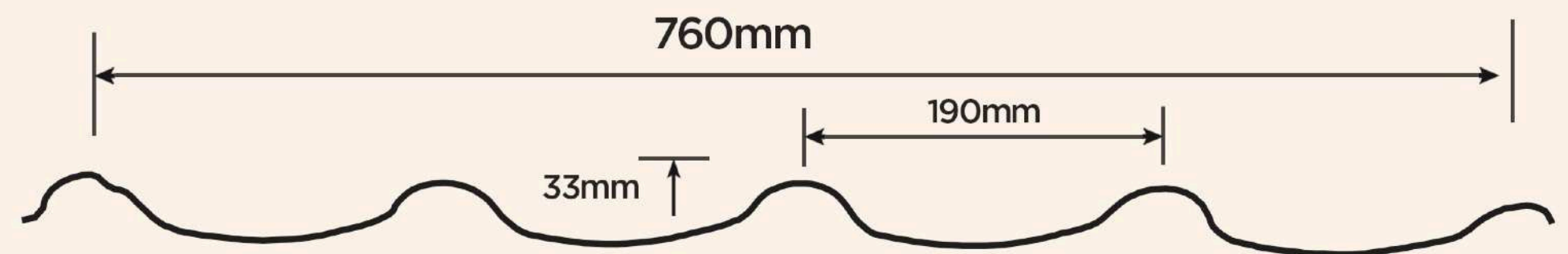

Dsm
roofing
sheltering you

ATAP SIFU
V-BOND TILES

V-BOND TILES are our unique patented design roof tiles, also known as stone coated aluminium-zinc roof tiles. V-BOND TILES offer builders the perfect blend of lightweight durability and the classic allure of traditional clay or concrete tiles. The granulated texture not only authentically mimics the appearance of traditional tiles but also dampens rain noise and enhances surface scratch resistance. Available in an array of vibrant colors, V-BOND TILES are resilient against high-velocity winds and hailstorms, ensuring a reliable and aesthetically pleasing roofing solution for any project.

- **Seamless:** Seamless screw locking system
- **Aesthetics:** Classic and timeless
- **Strength:** High impact resistance

Product Certification: CIDB PPS MS2500 : 2012

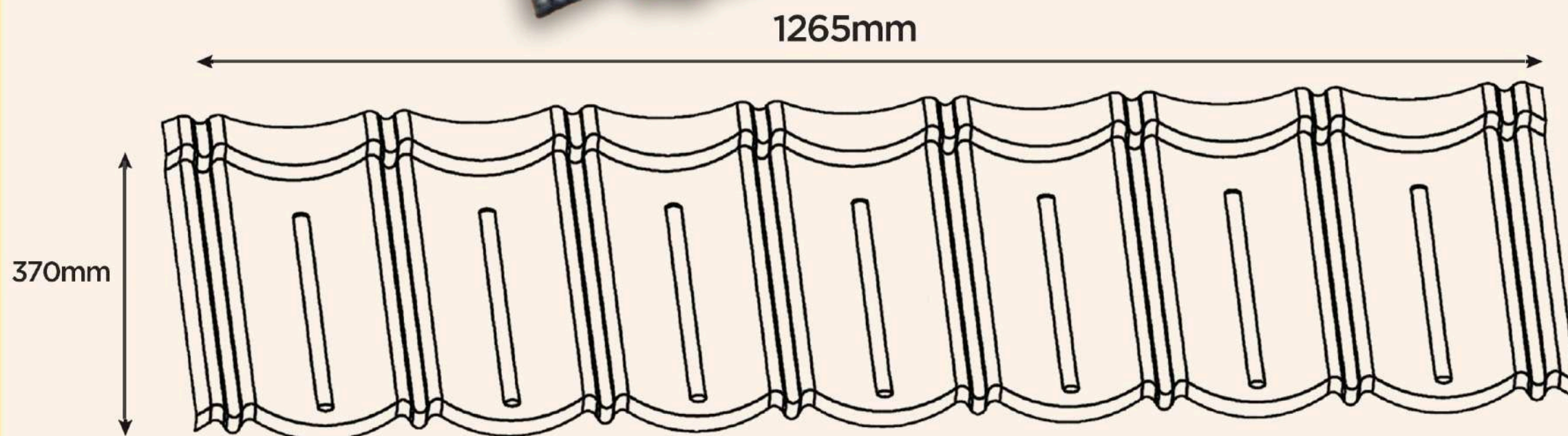
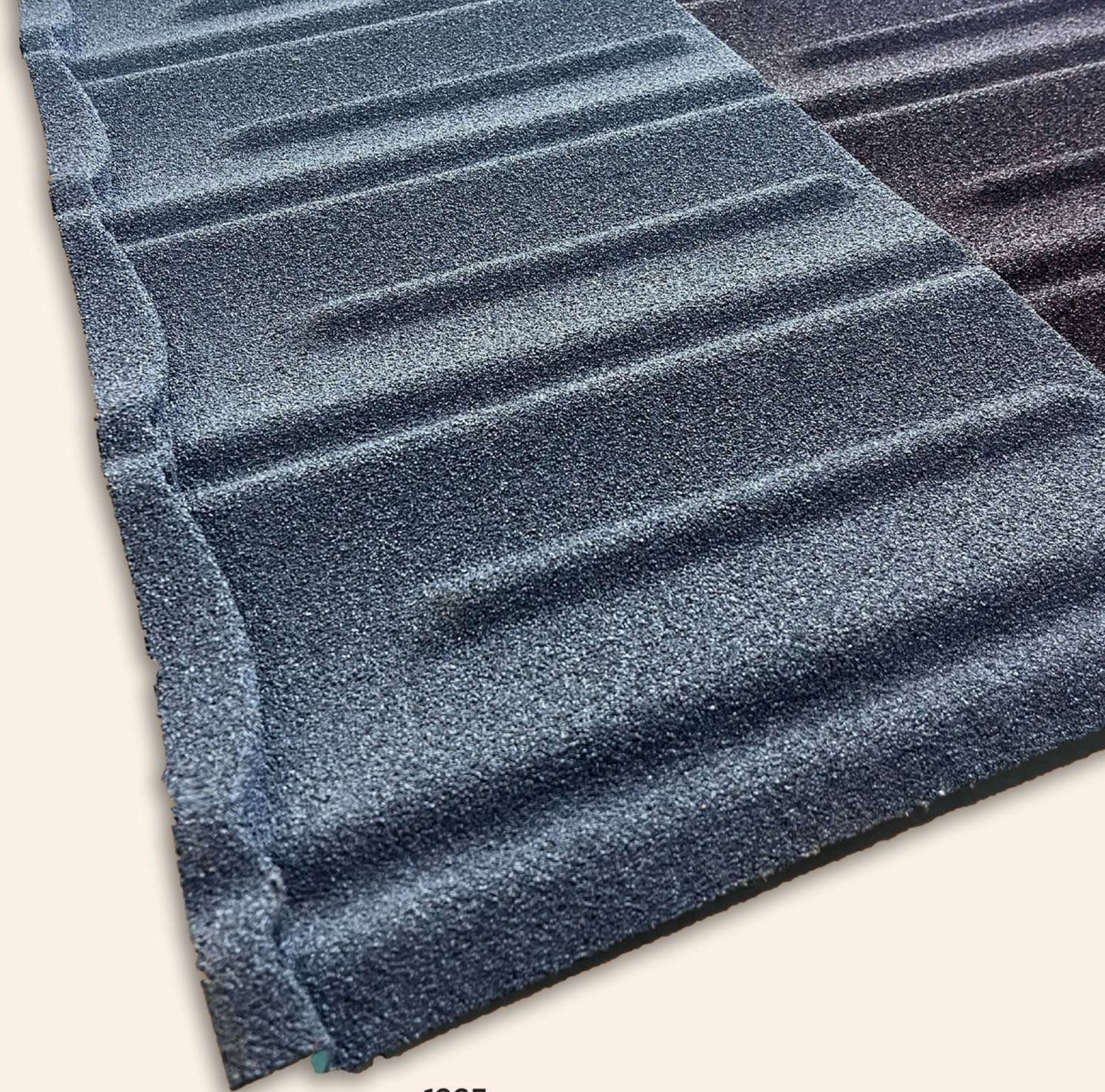



Foamdek25

ALUMINIUM PU FOAM Roof Sandwich

OSM Aluminium Foamdek®25 is a complete insulated metal roof panel with excellent thermal efficiency. It consists of three layers: pre-painted metal deck, rigid polyurethane (PU) foam, and aluminium foil. It is heat-resistant, durable, and provides good sound absorption.

Effective Width: 762mm
Depth of Rib: 25mm
Yield of Strength: G550
Min. Roof Pitch: 3° sheet without end lap
Tolerance: Length ± 5 mm, Width ± 3 mm, Thickness ± 0.03 mm

- Easy installation
- Convenient for installers
- Save cost of installation

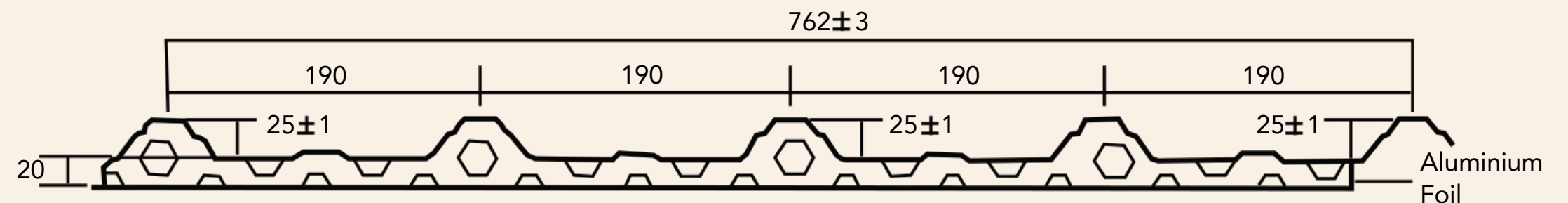
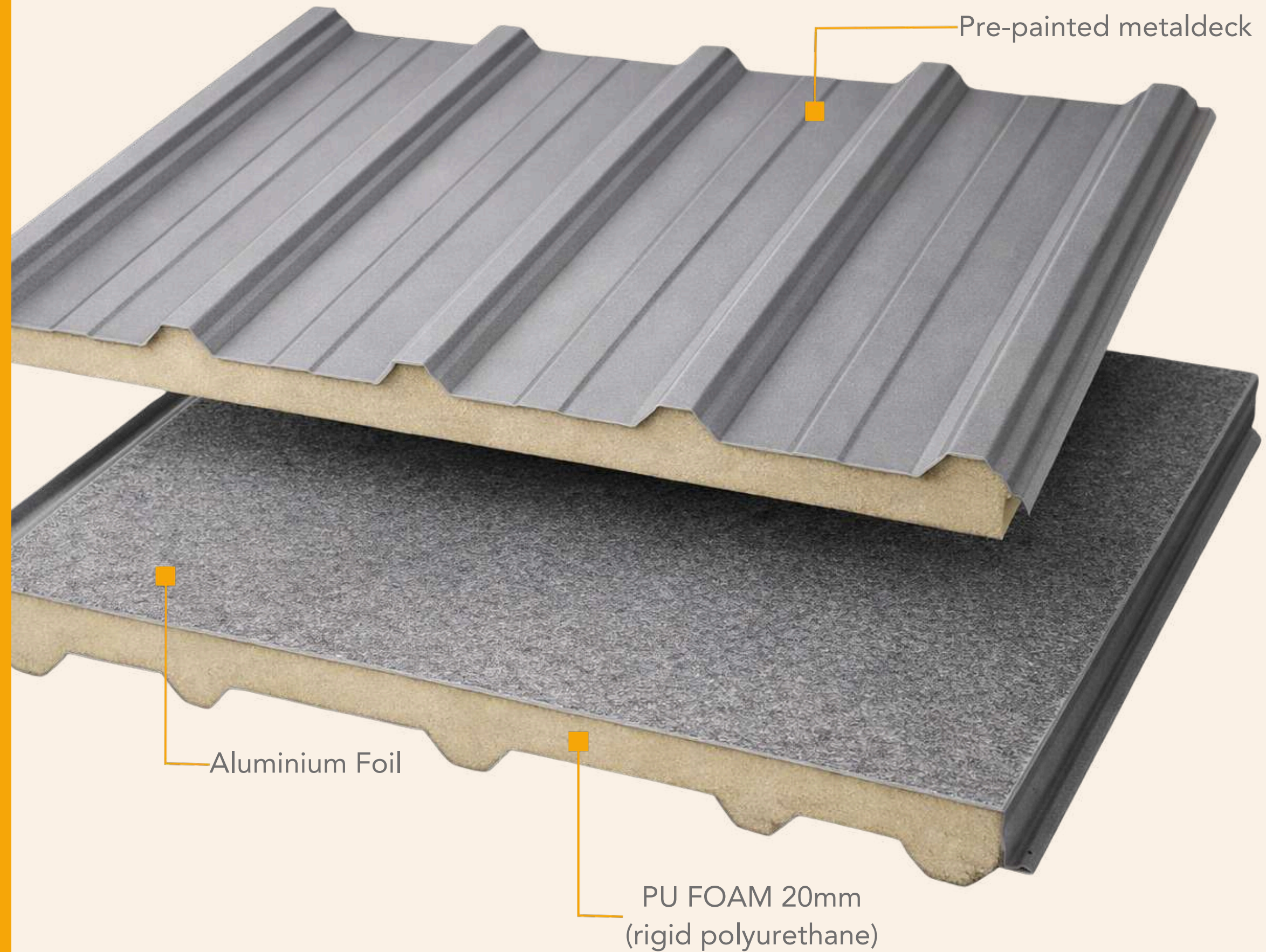



Foamdek25

PVC PAPER PU FOAM Roof Sandwich

OSM PVC Paper Foamdek®25 is a premium insulated metal roof panel engineered for excellent thermal efficiency. It features a three-layer structure: pre-painted metal deck, high-density polyurethane (PU) foam, and PVC paper. Designed for heat resistance, durability, and superior sound absorption, it can also be customized into a standard curve to suit various architectural needs.

Depth of Rib: 25mm
 Yield of Strength: G300 / G550
 Min. Roof Pitch: 3° sheet without end lap
 Tolerance: Length ± 5 mm, Width ± 3 mm, Thickness ± 0.03 mm

- Easy installation
- Convenient for installers
- Durable and long lasting

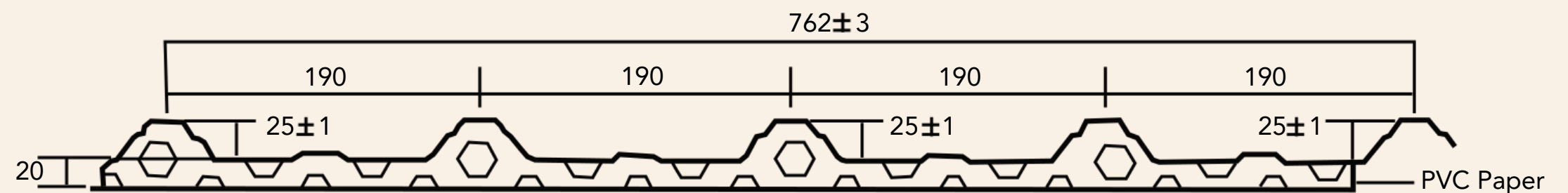
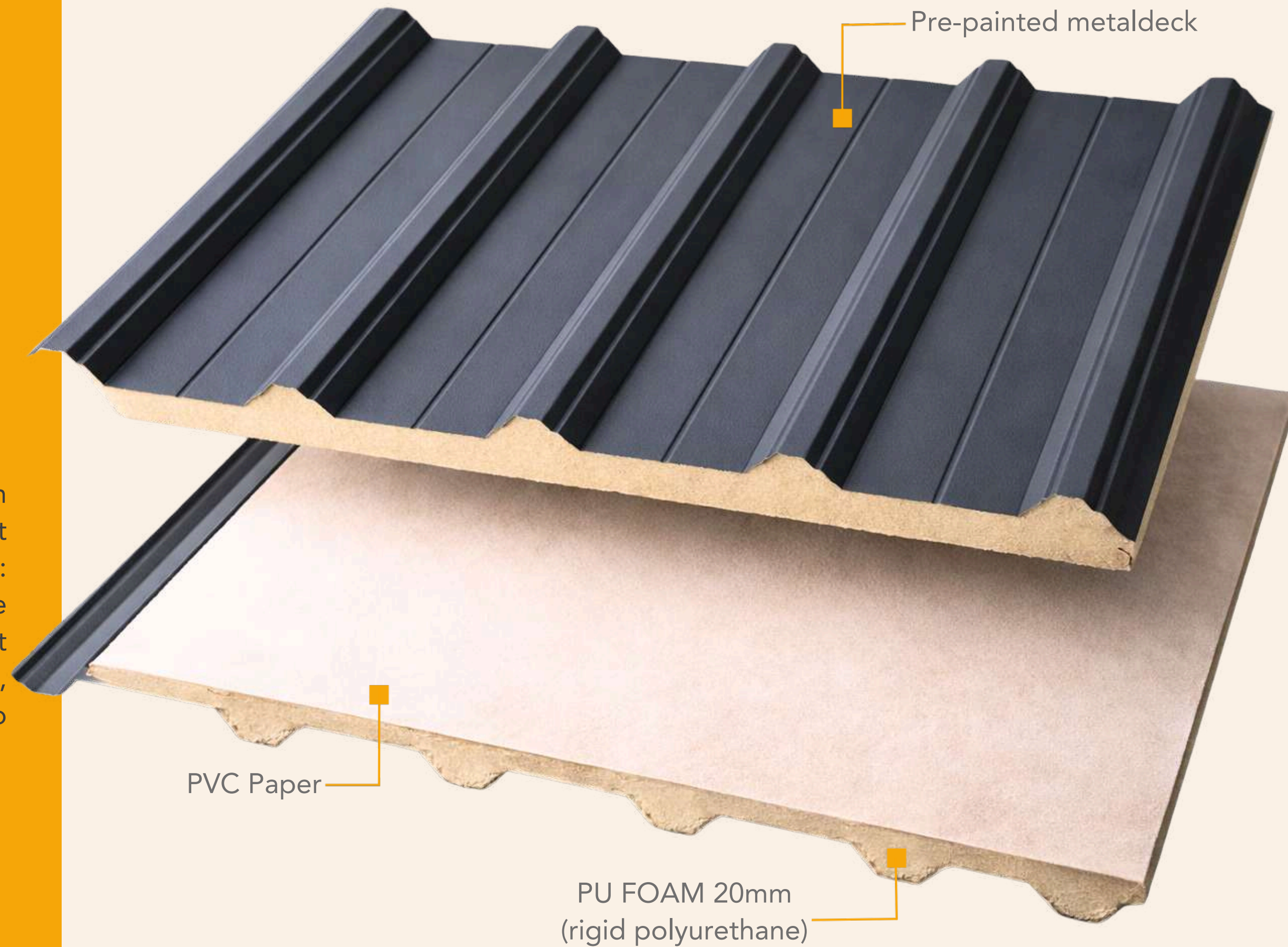



Foametal25

PU METAL Roof Sandwich

OSM Foametal@25 is a complete insulated metal roof panel with excellent thermal efficiency. It consists of three layers: pre-painted metal deck, rigid polyurethane (PU) foam, and pre-painted metal sheet. It is heat-resistant, durable, and provides good sound absorption. It can also be customized into a standard curve.

Depth of Rib: 25mm
Yield of Strength: G300 / G550
Min. Roof Pitch: 3° sheet without end lap
Tolerance: Length ± 5 mm, Width ± 3 mm, Thickness ± 0.03 mm

- **Easy** installation
- **Convenient** for installers
- **Durable** and long lasting

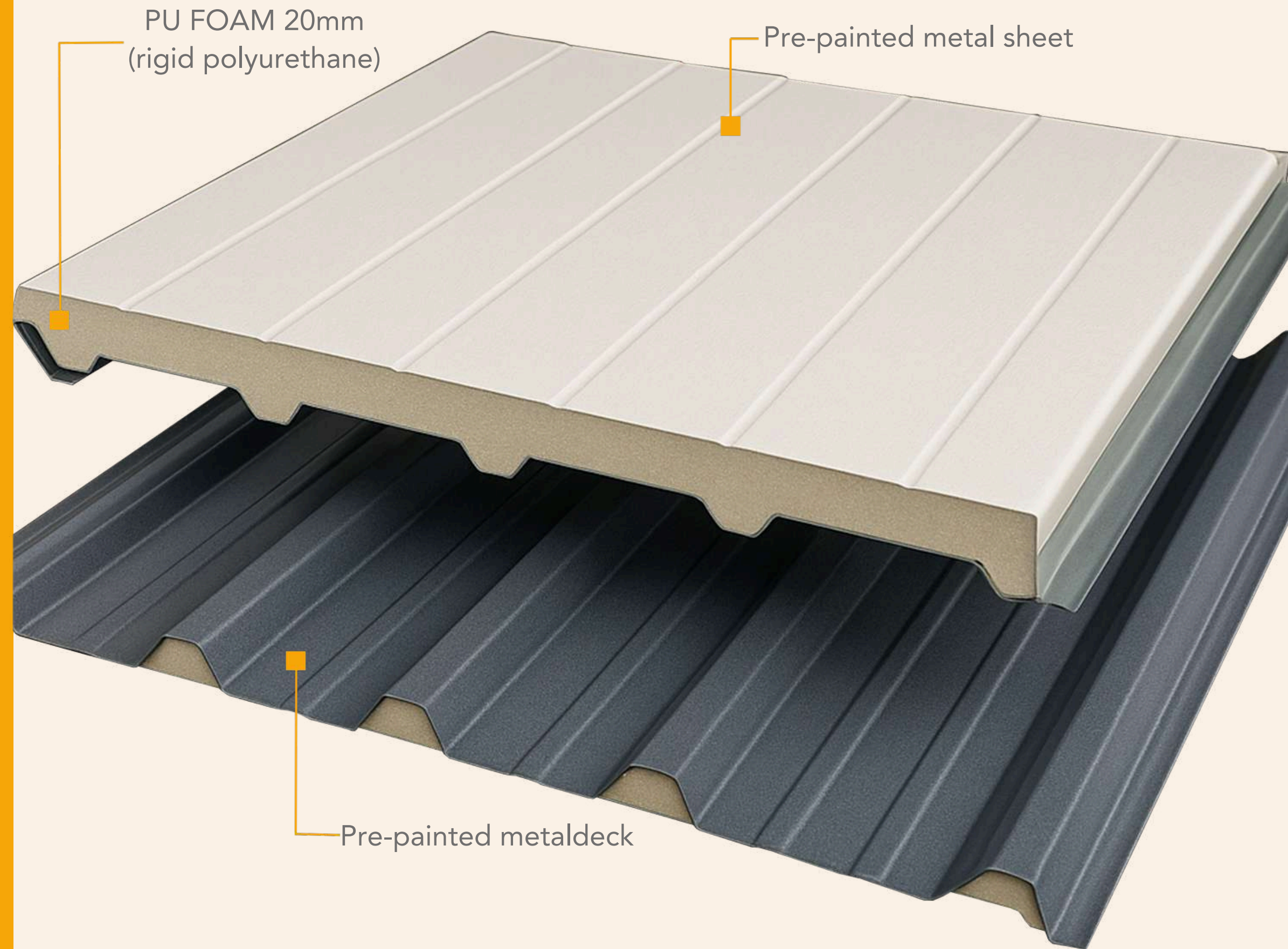

PU FOAM 20mm
(rigid polyurethane)

Pre-painted metal sheet

Pre-painted metaldeck

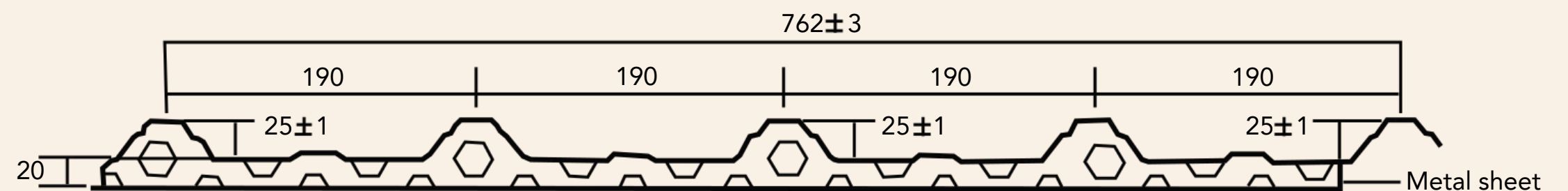

SOLAR CLIP COMPATIBILITY

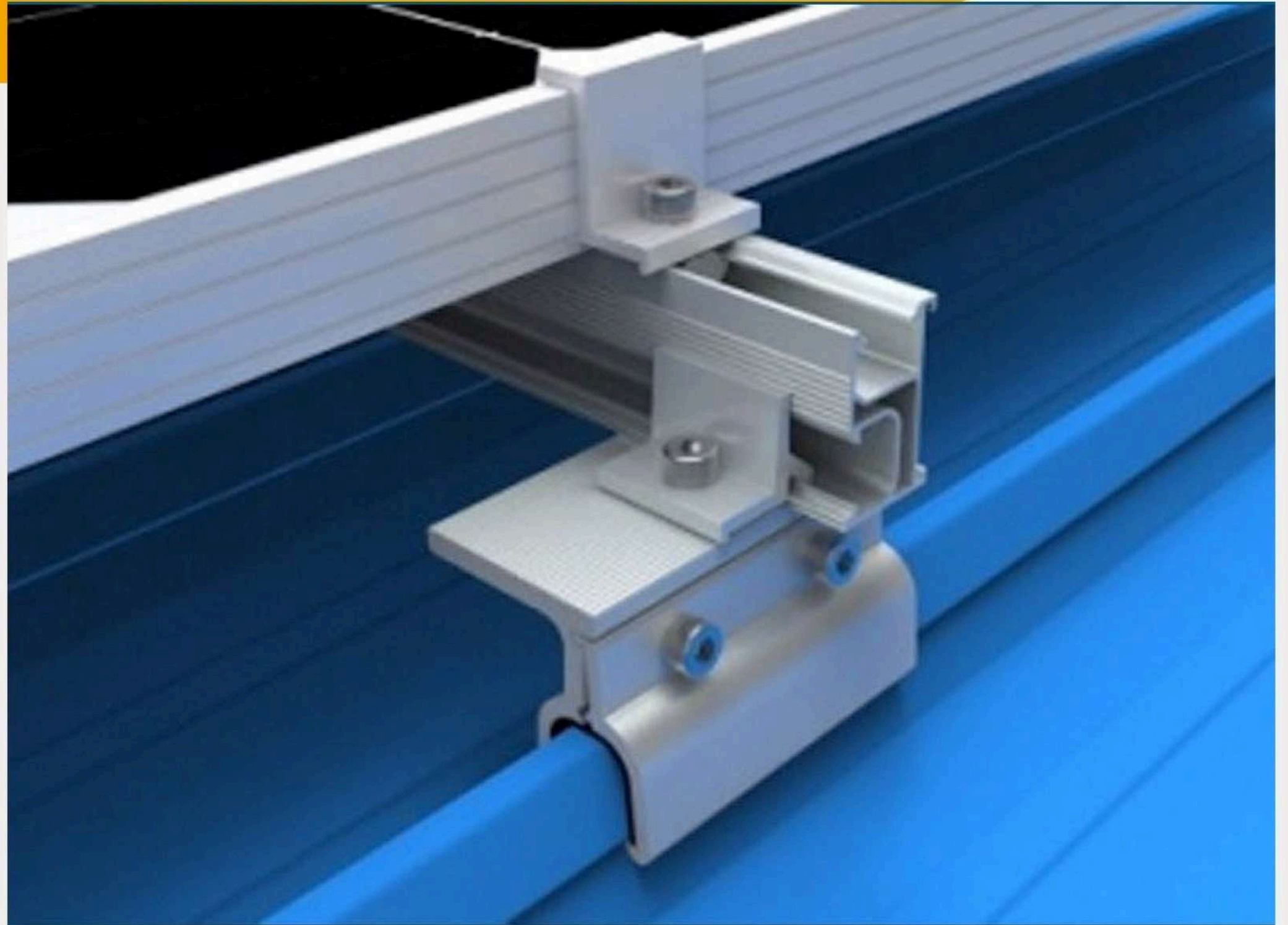
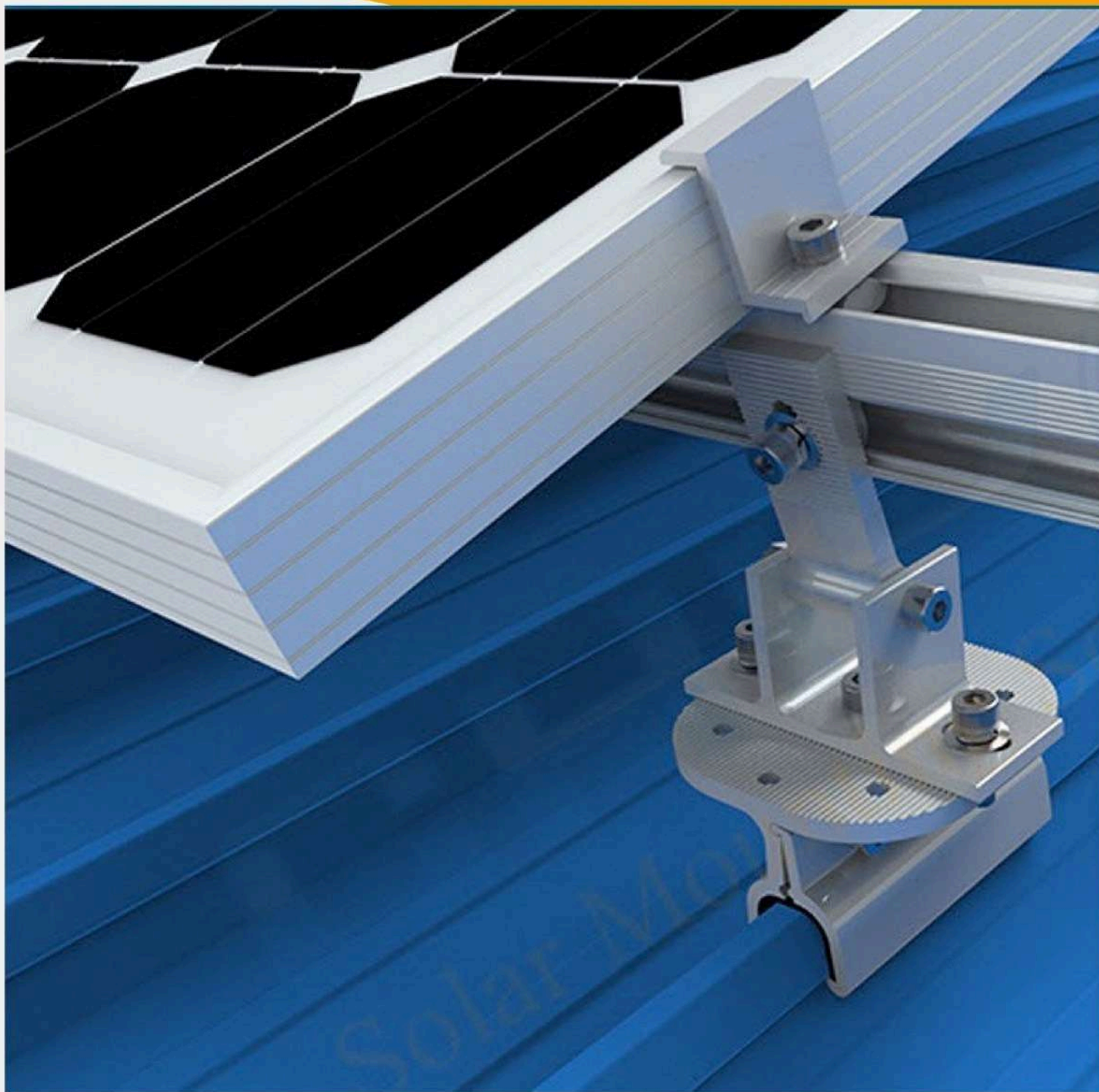



Aesthetic Comparison

Quād30
Concealed screw grip & lock profile

HICONDEK[®]40
Cliplock Roof Panel



HICONDEK®40

Cliplock Roof Panel

• PLUS INSULATION SYSTEM

OSM HICONDEK®40
Clip & Lock Roof Profile

10kg/m³
Glasswool

Aluminium Leno Foil
Alu/MPet

C-Purlin

- 10kg/m³ Fibre Glasswool

- Achieving good thermal resistance and sound transmission class

- Achieves U-Value 0.674W/m²K & minimum STC 21

- Aluminium Leno Foil (Alu/MPET) reflects 97% of radiant heat

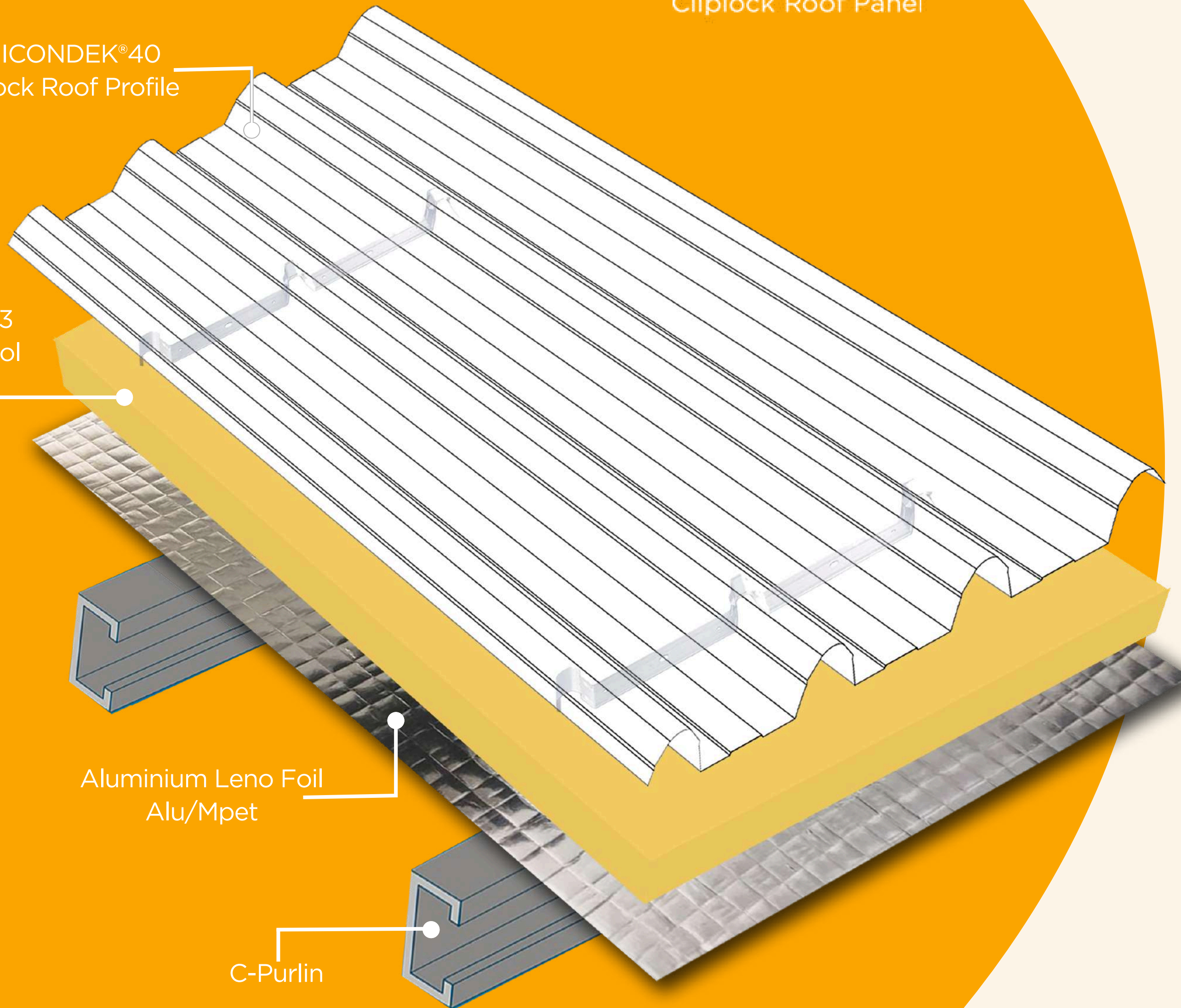

HICONDEK®40

Cliplock Roof Panel

•PRO INSULATION SYSTEM

OSM HICONDEK®40
Clip & Lock Roof Profile

40kg/m³
Rockwool
OR 16kg/m³
Fibreglass wool
50mm (thk)

Aluminium Leno Foil
Alu/MPet

C-Purlin

- 40kg/m³ Rockwool OR 16kg/m³ Fibreglass wool 50mm thickness

- Achieving good thermal resistance and sound transmission class

- Achieves U-Value 0.627W/m²K or 0.644W/m²K & minimum STC 21

- Aluminium Leno Foil (Alu/MPET) reflects 97% of radiant heat

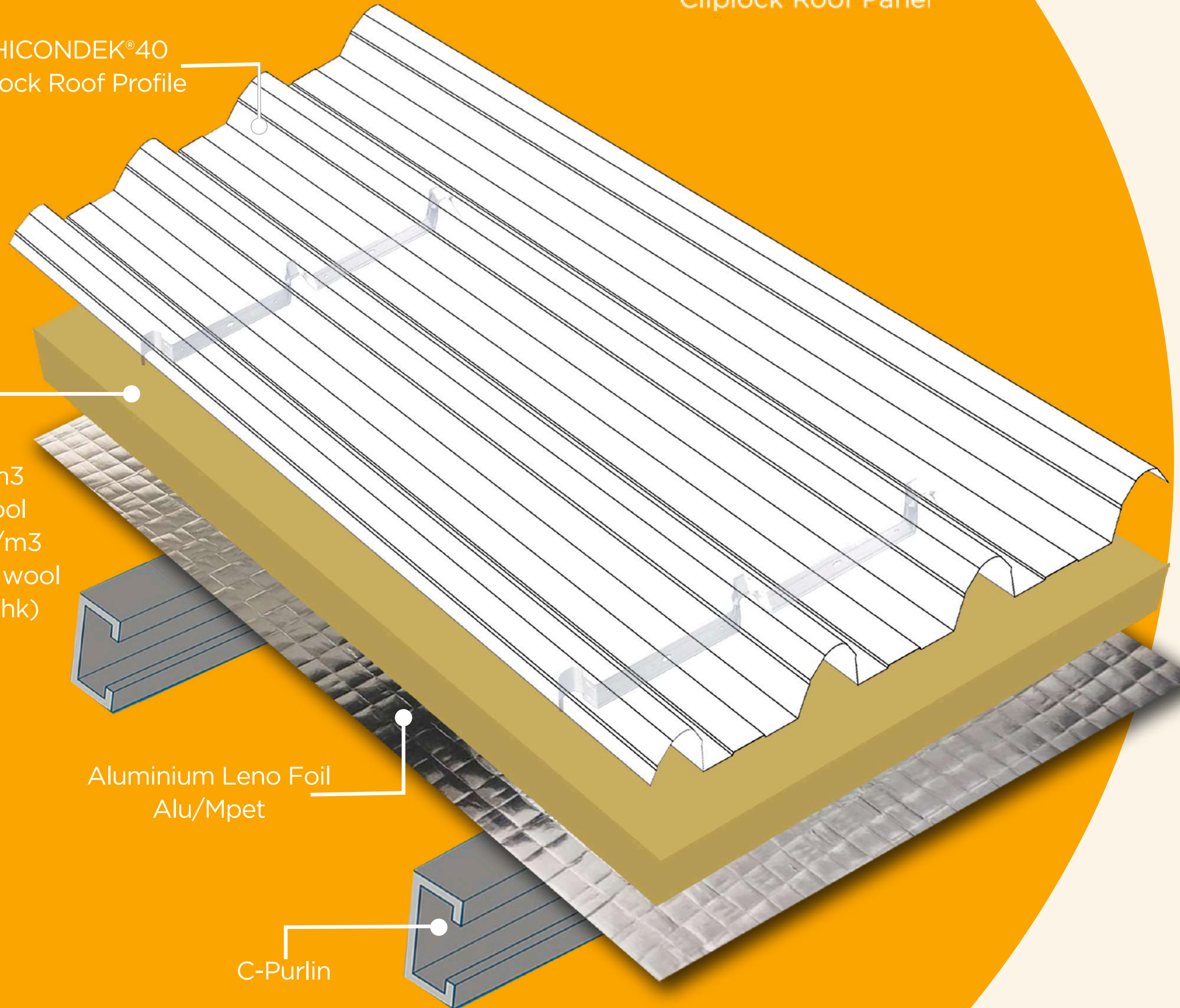

HICONDEK®40

Cliplock Roof Panel

•PRO INSULATION SYSTEM WITH PLASTER BOARD

OSM HICONDEK®40
Clip & Lock Roof Profile

40kg/m³
Rockwool
OR 16kg/m³
Fibreglass wool
50mm (thk)

Aluminium Leno Foil
Alu/MPet

C-Purlin

9mm Plasterboard

- 40kg/m³ Rockwool OR 16kg/m³ Fibreglass wool 50mm thickness

- Achieving good thermal resistance and sound transmission class

- Achieves U-Value 0.353W/m²K & minimum STC 21

- Aluminium Leno Foil (Alu/MPET) reflects 97% of radiant heat

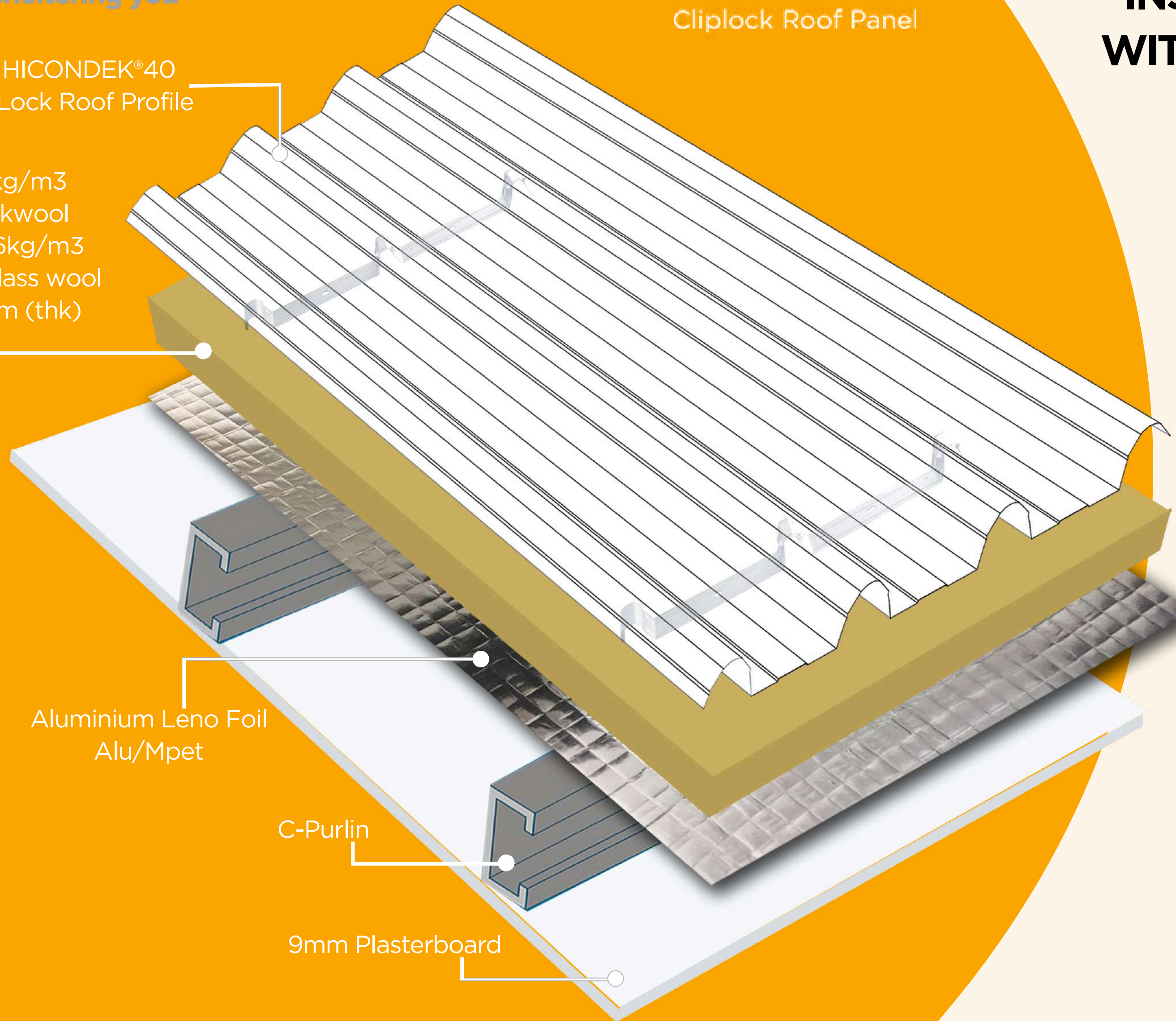

HICONDEK®40

Cliplock Roof Panel

• PRIME INSULATION SYSTEM

OSM HICONDEK®40
Clip & Lock Roof Profile

ZED Spacer

40kg/m³ Rockwool
100mm (thk)
OR 16kg/m³ Glasswool

Aluminium Leno Foil
Alu/Mpet

C-Purlin

- Roof color with SRI > 78

- 40kg/m³ Rock Wool
50mm x 2 layers (100mm)

- Achieving great thermal
resistance of U-Value 0.344
W/m²k

- Achieving great sound
resistance of STC31

- Aluminium Leno Foil
(Alu/MPET) reflects 97% of
radiant heat

- OSM Zed Spacer allows
glasswool to sit without
being compressed.

INSULATION SYSTEM WITH CEILING BOARD

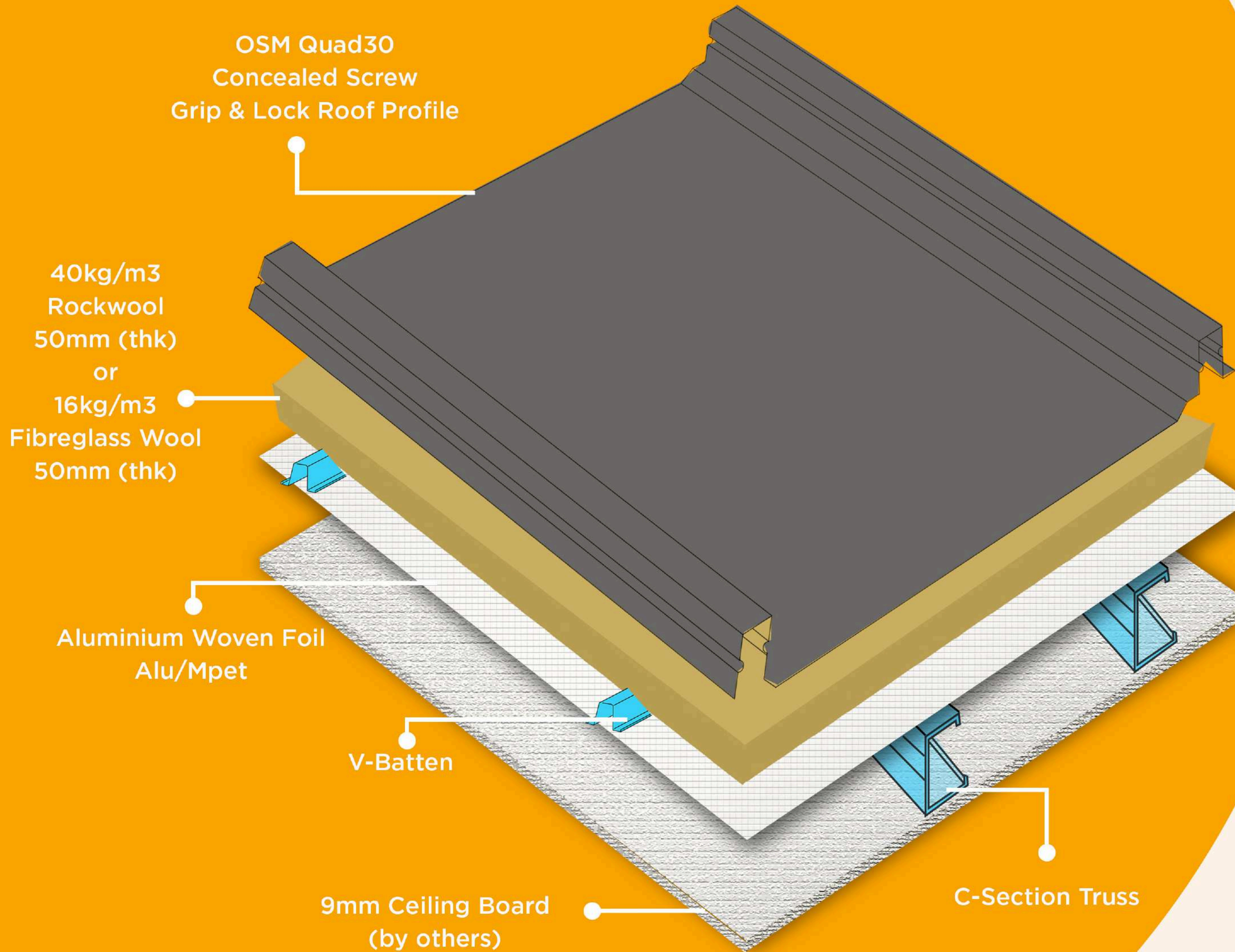

- 40kg/m³ Rockwool OR
16kg/m³ Fibreglass wool
50mm thickness

- Achieving great thermal
resistance and sound
transmission class

- Achieves U-Value 0.367W/m²K
or 0.373W/m²K & minimum
STC 28

- Aluminium Woven Foil
(Alu/MPET) reflects 97%
of radiant heat

TWINZIP®25

Standing Seam Roof Profile

• **MAX**

INSULATION SYSTEM

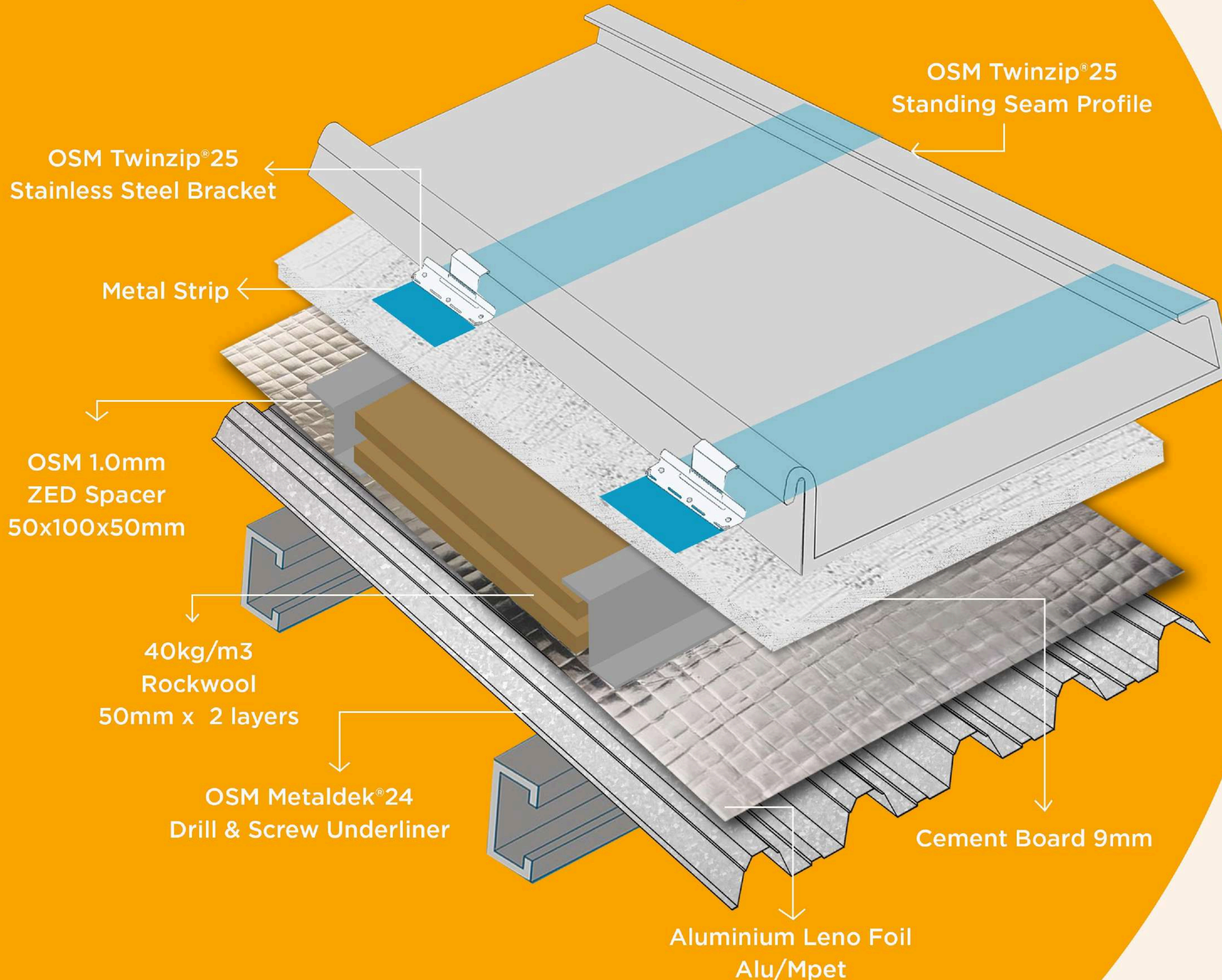

- 9mm Fibre Cement Board

- 16kg Fibre GlassWool / 50mm thick

- Achieving great thermal resistance of U- Value 0.24 W/m²k

- Achieving great sound resistance of min STC42

- Aluminium Woven Foil (Alu/MPET) reflects 97% radiant heat

- OSM Zed Spacer allows wool to sit without being compressed.

TWINZIP®25

Standing Seam Roof Profile

SMART INSULATION SYSTEM

OSM Twinzip®25
Stainless Steel Bracket

OSM Twinzip®25
Standing Seam Profile

- 40kg/m³ Rock Wool
50mm thickness
x 2 layers (=100mm)

Metal Strip

- Achieving great thermal
resistance of U- Value
0.313 W/m²k

PE Foam

- Achieving good sound
resistance of STC34

- Aluminium Woven Foil
(Alu/MPET) reflects 97%
radiant heat

OSM Metaldek®24
Drill & Screw
Underliner

Zed Spacer
200mm girth
(50x100x50mm)

40kg/m³ Rockwool
50mm x 2 layers

Aluminium Woven Foil
Alu/Mpet

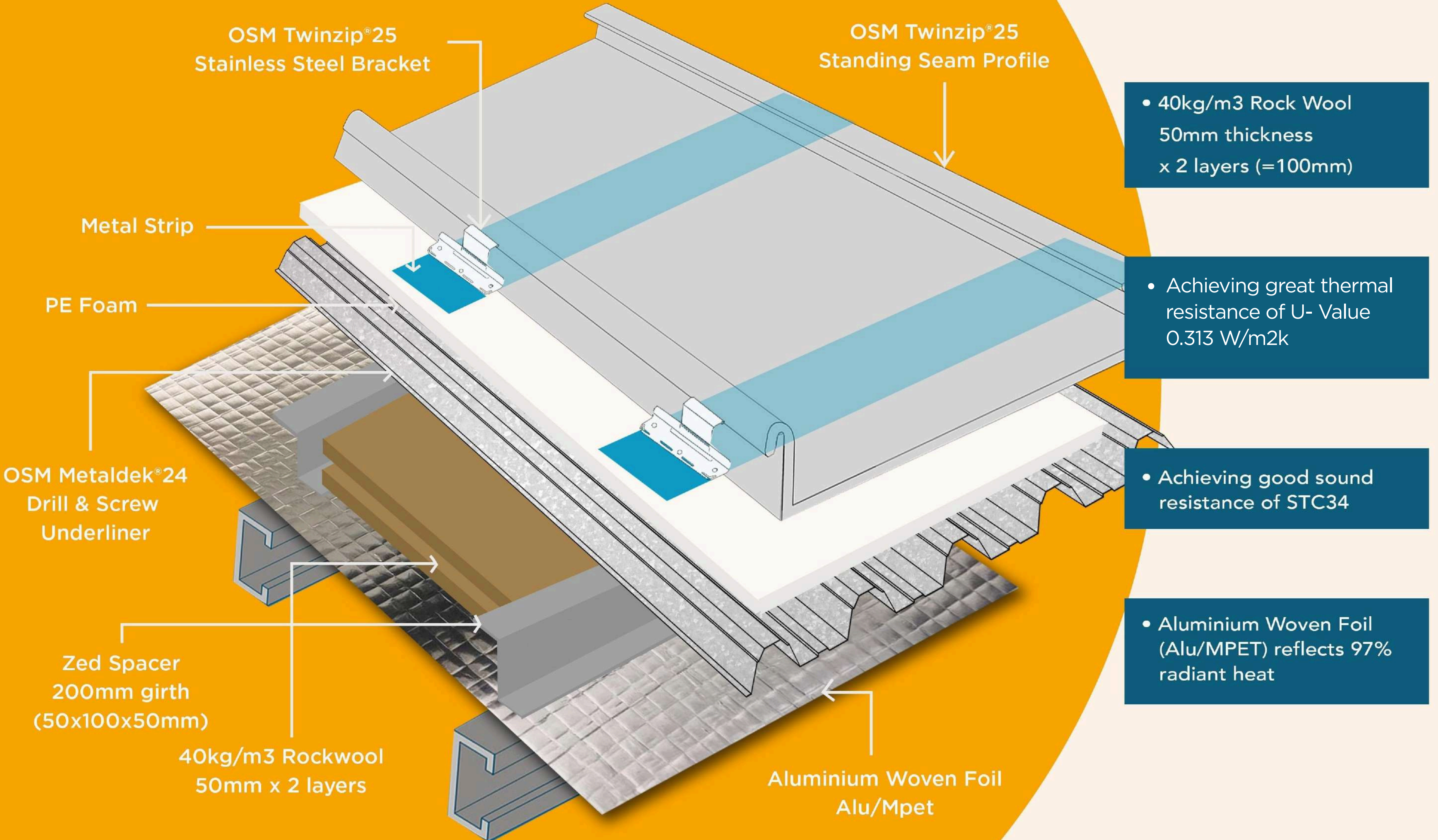

MATERIAL COATINGS

| Thickness TCT | Coating Element | Coating Thickness | Sirim Corrosion Class | Warranty | Certifications | Colours |
|-------------------------------------|--|---|---|---|--|--|
| <p>0.40mm 0.47mm 0.53mm</p> | <p>100% Zinc + Polyester Paint with Primer</p> | <p>Z180 25µm + Primer Coat 37µm</p> | <p>C4-T (High or Tropical) = Industrial areas or coastal areas with moderate salinity</p> | <p>20 Years Perforation + 10 Years Colour Performance</p> | <p>MS 2383: 2011 + JIS G3312</p> | <p>Mist Grey SRI 62 Rocky Grey SRI 53 Yodo Grey Med Grey Horizon Blue Fina Blue Almond Beige Off-White SRI>78</p> |

MATERIAL COATINGS

| Thickness TCT | Coating Element | Coating Thickness | Sirim Corrosion Class | Warranty | Certifications | Colours |
|----------------------------|---|--|--|---|---------------------------------|---|
| 0.48mm 0.50mm 0.55mm | 100% Zinc + Super Polyester Paint with Primer (hydrophilic pigment) | Z275 38µm + Thermoshield Coat 42µm | C5-I (Very High or Industrial) = Industrial areas with high humidity & aggressive atmosphere | 30 Years Perforation + 12 Years Colour Performance + 5 Years Dirt & Stain | MS 2383: 2011 + JIS G3312 | Mist Green SRI 41 Optimistic Grey SRI 42 Med Grey Off-White SRI 78 |

MATERIAL COATINGS

| Thickness TCT | Coating Element | Coating Thickness | Sirim Corrosion Class | Warranty | Certifications | Colours |
|---------------|---|-------------------------------------|---|--|---------------------------------|--|
| 0.56mm | 100% Zinc + Pvdf Paint (>70% Polyniny-lidene Fluoride binder) | Z275 38µm + Supreme Coat 42µm | C5-M (Very High, Geothermal Marine) = Coastal & Offshore areas with high salinity | 30 Years Perforation + 15 Years Colour Performance | MS 2383: 2011 + JIS G3312 | All available colors upon MOQ Other colors upon MOQ |

MATERIAL COATINGS

Thickness
TCT

0.47mm

Coating
Element

100%
Zinc

+

Polyester
Paint
with
Primer

Coating
Thickness

Z180
25µm

+

Tekstur
Coat
38µm

Sirim
Corrosion
Class

C4-T
(High or
Tropical)

=

Industrial
areas
or
coastal
areas
with
moderate
salinity

Warranty

20
Years
Perforation

+

10
Years
Colour
Performance

Certifications

MS
2383:
2011

+

JIS
G3312

Colours

Wool
White

Copper
Brown

Stone
Grey

MATERIAL COATINGS

Thickness
TCT

0.40mm
0.47mm
0.53mm

Coating
Element

55%
Aluminium

+

43.5%
Zinc

+

1.5%
Silicon

Coating
Thickness

AZ150
41µm

Sirim
Corrosion
Class

NIL

Warranty

25
Years
Perforation
Warranty

Certifications

MS
1196:
2004



OSM ROOFING'S RESIDENT COLORS

Our signature color range is carefully selected to enhance durability, aesthetics, and performance. Designed to withstand the elements, these colors offer long-lasting vibrancy and protection.

For accurate color selection, please request a real color sample from OSM.

COLORS

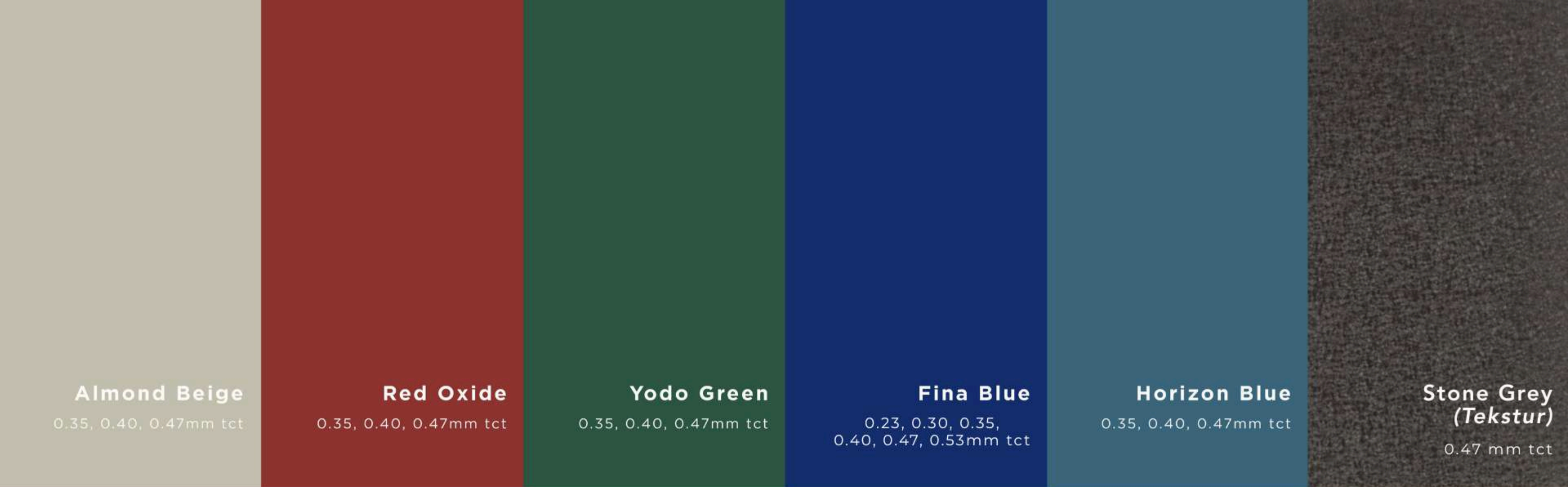

Almond Beige

0.35, 0.40, 0.47mm tct

Red Oxide

0.35, 0.40, 0.47mm tct

Yodo Green

0.35, 0.40, 0.47mm tct

Fina Blue

0.23, 0.30, 0.35,
0.40, 0.47, 0.53mm tct

Horizon Blue

0.35, 0.40, 0.47mm tct

**Stone Grey
(Tekstur)**

0.47 mm tct



C O L O R P a l e t t e

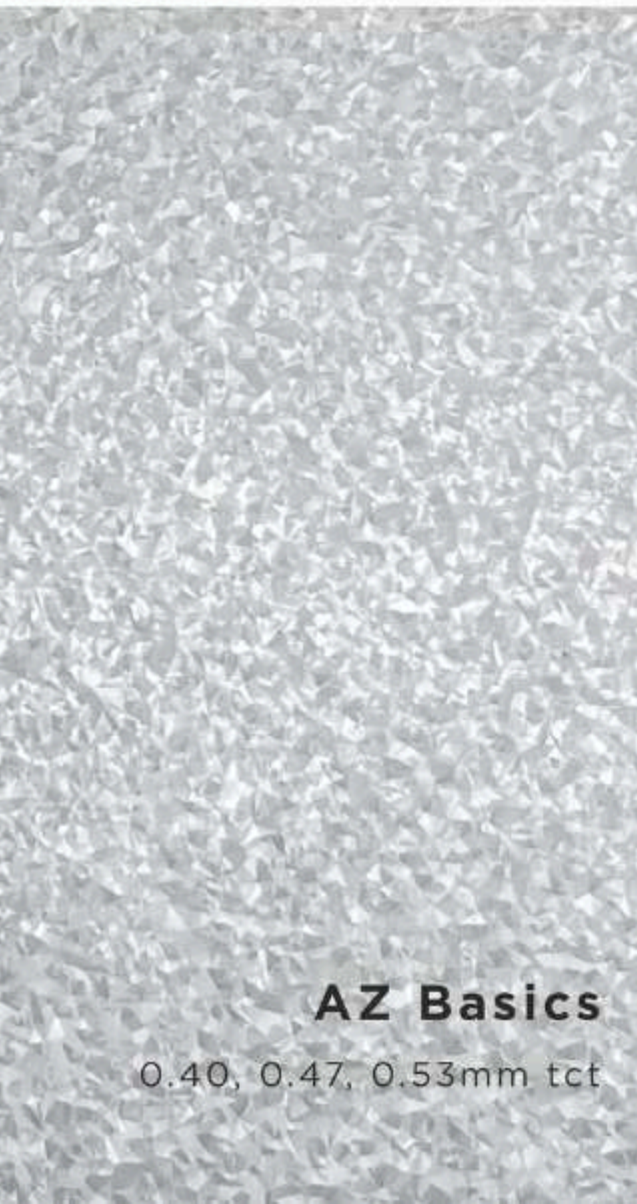

AZ Basics

0.40, 0.47, 0.53mm tct

Lily White

0.47mm tct

Mist Grey

0.40, 0.47mm tct

Rocky Grey

0.35, 0.40, 0.47mm tct

Yodo Grey

0.40, 0.47mm tct

Shell Grey

0.40, 0.47mm tct

Colors may vary due to printing, screens, and lighting.

U-VALUE REPORT

THERMAL TRANSMITTANCE VALUE OF OSM ROOF SYSTEM



CLIENT:

PROJECT TITLE:

ROOF SYSTEM: OSM HICONDEK®40 PRIMERO PRO ROOF SYSTEM WITH ATTIC

PREPARED BY: MS DESIREE DATE: 09-May-24

| LAYER (from top) | COMPONENTS | THICKNESS (mm) | CONDUCTIVITY (W/mk) | RESISTANCE (m2K/W) |
|---------------------|---|-------------------|------------------------|-----------------------|
| | External Surface | | | 0.044 |
| Roof_Panel | OSM_Hicondek_40_PRIMERO_Roof_Panel | 0.47 | 50 | 0 |
| Insulation | Fibreglass_wool_16kg/m3 (EWBL 1.35)_50mm | 50 | 0.0366 | 1.35 |
| Insulation | Aluminium_Woven_Foil | 0.05 | 200 | 0 |
| Airgap | Attic Space (non-ventilated with IR Reflective) | | | 1.09 |
| Insulation | 9.5mm Plasterboard | 9.5mm | 0.25 | 0.038 |
| | Internal Surface | | | 0.16 |
| | Total Resistance | | m2K/W | 2.682 |
| | U-Value | | W/m2K | 0.373 |

Technical specifications as shown in this table are intended to be used as general guidelines only. The physical and chemical properties of the components listed herein represent typical average values obtained in accordance with accepted test methods and are subject to normal manufacturing variations. They are supplied as a technical service and are subject to change without notice. We shall not be held responsible for the accuracy of this information.

Sound Insulation Prediction (v8.0.12)

Program copyright Marshall Day Acoustics 2015

OSM ROOFING - Key No. 4503

Margin of error is generally within STC +/- 3 dB

Job Name: STC REPORT

Notes:

Job No.:

Page No.:

HICONDEK40 PRO ROOF SYSTEM

Date: 7 Jul 21

Initials:

File Name: insul



STC 28
OITC 23

System description

Panel 1 : 1 x 0.5 mm HICONDEK40 Cliplock Roof Panel (p:7200 kg/m3,E:4.7GPa,η:0.01, ps:3.6 kg/m², fc:1.61E5 Hz)

Absorptive facing : Rockwool 40kg/m3 x 50mm Thickness 50 mm

| frequency (Hz) | TL(dB) | TL(dB) |
|----------------|--------|--------|
| 50 | 12 | |
| 63 | 13 | 13 |
| 80 | 14 | |
| 100 | 15 | |
| 125 | 16 | 16 |
| 160 | 17 | |
| 200 | 19 | |
| 250 | 20 | 20 |
| 315 | 22 | |
| 400 | 24 | |
| 500 | 25 | 25 |
| 630 | 27 | |
| 800 | 29 | |
| 1000 | 31 | 30 |
| 1250 | 32 | |
| 1600 | 31 | |
| 2000 | 29 | 29 |
| 2500 | 28 | |
| 3150 | 29 | |
| 4000 | 30 | 30 |
| 5000 | 31 | |

Panel Size 2.7x4 m, Mass 4.5 kg/m²

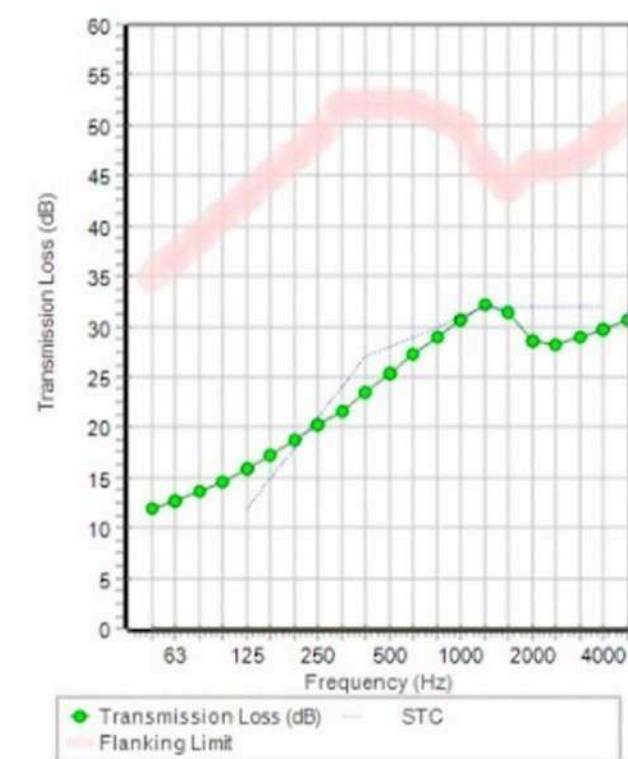

LTD1313



BECKER LTD GROUP RADIATIVE PROPERTY TEST FACILITY
Determination of Solar Reflectance Index (based on PI-LTM-314)

Study : S12-313 (Part 1)
 Date : 28.9.2012

Client : BICM
 Time : 13.30

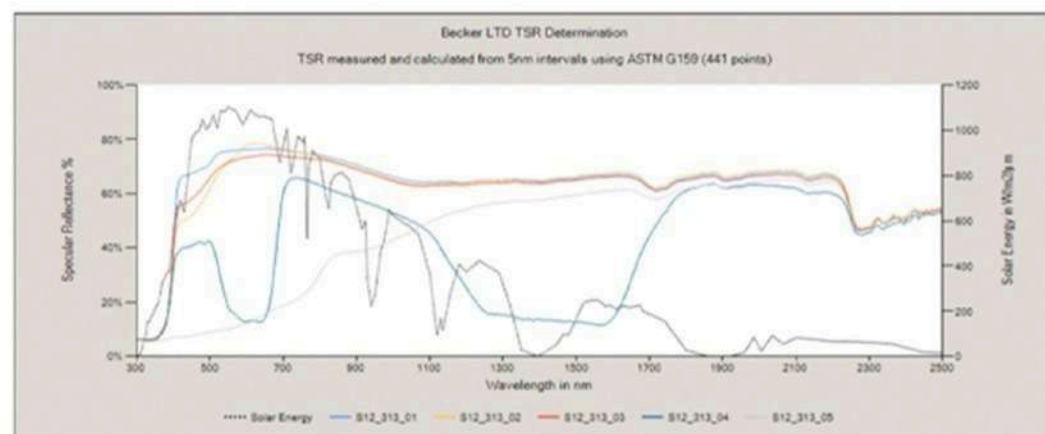

| Sample Name | Total Solar Reflectance (%) | UV Range (300-395 nm) | Visible Range (400-720 nm) | Near Infrared Range (725-2500 nm) | Thermal Emissivity | SRI (h _c =5 W/m ² ·K ⁻¹) | SRI (h _c =12 W/m ² ·K ⁻¹) | SRI (h _c =30 W/m ² ·K ⁻¹) |
|--------------------------|-----------------------------|-----------------------|----------------------------|-----------------------------------|--------------------|--|---|---|
| S12-313-01 Milky Green | 69% | 12% | 74% | 69% | 0.80 | 83 | 84 | 85 |
| S12-313-02 Off White | 67% | 12% | 69% | 69% | 0.86 | 78 | 79 | 80 |
| S12-313-03 Neutral Beige | 67% | 12% | 69% | 68% | 0.82 | 78 | 79 | 80 |
| S12-313-04 Blue Danube | 39% | 12% | 30% | 48% | 0.85 | 41 | 42 | 44 |
| S12-313-05 Mocha Fudge | 30% | 6% | 12% | 45% | 0.85 | 29 | 30 | 32 |

The test results reported above have an uncertainty of ±3 units SRI under conditions of ± 2% measurement uncertainty in reflectance units. The measurement uncertainty for thermal emissivity of ± 0.04 emissivity units gives an uncertainty of ±2 units variation in SRI. Together these give a total uncertainty for the SRI of ± 5 units. The uncertainty evaluation has been carried according to UKAS requirements.

Solar Reflectance Index (SRI) is determined according to ASTM E 980. This method uses the measured TSR (according to ASTM E 903) and measured thermal emissivity (according to ASTM C 1371). SRI gives an estimation of the steady state surface temperature and is quoted at three different convective coefficients (h_c); low (0-2 m.s⁻¹), medium (2-6 m.s⁻¹) and high (6-10 m.s⁻¹) wind speeds. A value of 100 is considered to be the reference white surface and a value of 0 the reference black surface.

This test conformed with all the requirements of PI-LTM-312, PI-LTM-313 and PI-LTM-314 which are based upon ASTM E 903, ASTM C 1371 and ASTM E 980 respectively.

Operative
 Name : Chan Mistry

Signature : *Chan Mistry*



2050



OUR PATENTED COOL ROOF SYSTEM
 is specially designed to reduce heat absorption, retain its glossiness and maintain its colour vibrancy.

PRE-PAINTED GALVANISED STEEL WITH SELF-CLEAN, COOL AND SUPER DURABLE FUNCTIONS

| | | | | | |
|--------------------------------|-----------------------------|---------------------------------|----------------------------|-------------------------|---------------------------|
| | | | | | |
| MONDAY BLUE SRI: 75 | MILKY GREEN SRI: 83 | IVORY GREY SRI: 73 | NEUTRAL BEIGE SRI: 78 | OFF WHITE 30 SRI: 78 | OAT BEIGE SRI: 68 |
| | | | | | |
| TORRES BLUE 30 SRI: 30 | MIST GREEN 30 SRI: 41 | GRACIER GREY SRI: 63 | MARINE GREY SRI: 34 | BROWNIE GOLD SRI: 58 | OAK SRI: 47 |
| | | | | | |
| BLUE WHALE SRI: 29 | AQUAMARINE SRI: 34 | OPTIMISTIC GREY SRI: 42 | ALMOND BEIGE 30 SRI: 63 | MOCHA BROWN SRI: 30 | ASPEN GREEN SRI: 29 |
| | | | | | |
| ROYAL BLUE SRI: 31 | DAYFLOWER BLUE SRI: 81 | MEADOWSWEET PINK SRI: 82 | BULBINE YELLOW SRI: 82 | PANSY BEIGE SRI: 66 | POINSETTIA RED SRI: 40 |
| | | | | | |
| CHAMPAGNE GOLD MICA SRI: 47 | PEBBLE GREY MICA SRI: 43 | BRONZITE BRONZE MICA SRI: 36 | | | |

Note: Solar Reflectance Index (SRI) values shown in this colour chart are approximate figures only. All regular colours shown in this colour chart are as close to the realcolor® Thermoshield colour. Please refer to our sales personnel for more information.



ON-SITE ROLL FORMING

ONSITE ROLL FORMING is made available for metal roofing longer than eighty (80) feet in length. We have extensive experiences for on-site management.



Preferred by Visionary Developers















誠隆研磚材有限公司是KOVAX正式授權代理商







Lotus's



Project References



ECO BUSINESS PARK II
ISKANDAR MALAYSIA



HONDA
YONG MING MOTOR SDN BHD



YONG MING









JLAND





BANDAR UNIVERSITI PAGOH



Property



CERTIFICATIONS



No Lesen : PC012113
Licence No :

LESEN PENSIJILAN BARANGAN

Product Certification Licence



SIRIM QAS International Sdn. Bhd. dengan ini menganugerahkan kepada SIRIM QAS International Sdn. Bhd. hereby grants to

OVERSEAMETAL SDN. BHD.
230 (B), JALAN KENCANA MAS 2
KAWASAN PERINDUSTRIAN TEBRAU 3
81100 JOHOR BAHRU
JOHOR, MALAYSIA



Lesen untuk menggunakan Tanda Pensijilan di atas barangan
a licence to use the Certification Mark on

SELF-SUPPORTING STEEL SHEET

Please refer to detail in the SCHEDULE



sebagai mematuhi keperluan
as complying with

MS 2500 : 2020

Ts. Md. Adha bin Katni @ Rahmat
Ketua Pegawai Eksekutif
Chief Executive Officer
SIRIM QAS International Sdn. Bhd.



SIRIM QAS International Sdn. Bhd.
((No. Syarikat 199601037981(410334-X)))

1, Persiaran Dato' Menteri
Seksyen 2, Peti Surat 7035
40700 Shah Alam
Selangor Darul Ehsan
MALAYSIA.

Tel : 603-5544 6000
Emel : cserviceqas@sirim.my

www.sirim-qas.com.my
https://www.malaysiancertified.com.my

Tarikh Mula Pensijilan : 04 November 2022

Certified Since

Sah Sehingga : 04 November 2026

Valid Until

Tarikh Dikeluarkan : 12 May 2026

Issue Date

No Siri : 127236

Serial No

Lesen ini dianugerahkan tertakluk kepada syarat-syarat Perjanjian Pensijilan Barangan SIRIM QAS International Sdn. Bhd.
This Licence is granted subject to the provisions of the Product Certification Agreement of SIRIM QAS International Sdn. Bhd.



No Lesen : PC012113
Licence No :

SCHEDULE

OVERSEAMETAL SDN. BHD.



Trade Mark : HICONDEK®
Model : HICONDEK@40
Rating : MATERIAL DESIGNATION WITH ORGANIC COATING = G550 + MIN Z180,
WITHOUT ORGANIC COATING = G550 + MIN AZ150;
Type : CONCEALED FIX SHEET
Size : TOTAL COATING THICKNESS (TCT) (mm) = 0.47- 0.53; COVER WIDTH (mm) = 700



Trade Mark : METALDEK®
Model : METALDEK@24;
Rating : MATERIAL DESIGNATION WITH ORGANIC COATING = G550 + MIN Z180,
WITHOUT ORGANIC COATING = G550 + MIN AZ150;
Type : TRAPEZOIDAL PROFILED SHEET WITH STIFFENERS
Size : TOTAL COATING THICKNESS (TCT) (mm) = 0.47 ; COVER WIDTH (mm) = 762



Trade Mark : METALDEK®
Model : METALDEK@26;
Rating : MATERIAL DESIGNATION WITH ORGANIC COATING = G550 + MIN Z180,
WITHOUT ORGANIC COATING = G550 + MIN AZ150;
Type : TRAPEZOIDAL PROFILED SHEET WITH STIFFENERS
Size : TOTAL COATING THICKNESS (TCT) (mm) = 0.47; COVER WIDTH (mm) = 757

Trade Mark : QUAD30™
Model : QUAD30
Rating : MATERIAL DESIGNATION WITH ORGANIC COATING = G550 + MIN Z180
Type : CONCEALED FIX SHEET
Size : TOTAL COATING THICKNESS (TCT) (mm) = 0.47 ; COVER WIDTH (mm) = 470

End of page

SIRIM QAS International Sdn. Bhd.
((No. Syarikat 199601037981(410334-X)))

1, Persiaran Dato' Menteri
Seksyen 2, Peti Surat 7035
40700 Shah Alam
Selangor Darul Ehsan
MALAYSIA.

Tel : 603-5544 6000
Emel : cserviceqas@sirim.my

www.sirim-qas.com.my
https://www.malaysiancertified.com.my

Tarikh Mula Pensijilan : 04 November 2022

Certified Since

Sah Sehingga : 04 November 2026

Valid Until

Tarikh Dikeluarkan : 12 May 2026

Issue Date

No Siri : 127236

Serial No

Lesen ini dianugerahkan tertakluk kepada syarat-syarat Perjanjian Pensijilan Barangan SIRIM QAS International Sdn. Bhd.
This Licence is granted subject to the provisions of the Product Certification Agreement of SIRIM QAS International Sdn. Bhd.

Page 1 of 1

CERTIFICATIONS



**PERAKUAN PEMATUHAN STANDARD
(BAHAN BINAAN)**

Adalah dengan ini Pengilang/Pengeluar yang dinyatakan di bawah ini telah mengeluarkan bahan binaan yang diperakui oleh Lembaga mengikut Bahagian VIIA Akta Lembaga Pembangunan Industri Pembinaan Malaysia (Pindaan 2011). Perakuan ini adalah tertakluk kepada syarat-syarat yang telah ditetapkan. Perakuan ini mengesahkan bahawa bahan atau produk binaan yang dinyatakan di bawah telah diperakukan

No. Pendaftaran : 1240121JH1131
 Nama Pengilang / Pengeluar : OVERSEAMETAL SDN. BHD.
 Alamat Kilang Berdaftar : 230(B), JALAN KENCANA MAS 2,
 KAWASAN PERINDUSTRIAN TEBRAU 3, 81100 JOHOR
 BAHRU,
 JOHOR

Kategori Bahan Binaan :

IRON AND STEEL PRODUCTS

(Rujuk LAMPIRAN A untuk butiran terperinci bahan atau produk binaan yang diperakukan)

Tarikh Mula Berkuatkuasa : 10-02-2026
 Tarikh Tamat Tempoh Perakuan : 09-02-2027

Perakuan ini boleh diperbaharui bermula 60 hari sebelum tarikh tamat tempoh perakuan.

Nota: Perakuan dikeluarkan setelah Lembaga menjalankan pemeriksaan dan pengesahan ke atas kilang dan produk-produk yang terkandung di dalam Pensijilan Produk (Product Certification) yang dikeluarkan oleh Badan Pensijilan yang diiktiraf. Pihak pengeluar/pengilang adalah bertanggungjawab untuk memastikan Pensijilan Produk (Product Certification) sentiasa dalam tempoh sahlaku.

ROZAIMAN HJ. HASSAN
 PENGARAH
 CIDB NEGERI JOHOR
 b.p Ketua Eksekutif



SIJIL INI ADALAH CETAKAN KOMPUTER DAN TIDAK MEMERLUKAN TANDATANGAN

No. Pendaftaran : 1240121JH1131
 Nama Pengilang / Pengeluar : OVERSEAMETAL SDN. BHD.

| Kategori | Jenis / Saiz | Jenama | Standard |
|-------------------------|---|----------|--------------|
| IRON AND STEEL PRODUCTS | Self-Supporting Steel Sheet Model: METALDEK®24; Type: TRAPEZOIDAL PROFILED SHEET; Size: TOTAL COATING THICKNESS (TCT)(mm) = 0.47, COVER WIDTH (mm) = 762 | METALDEK | MS 2500:2020 |
| | Self-Supporting Steel Sheet Model: METALDEK®26; Type: TRAPEZOIDAL PROFILED SHEET; Size: TOTAL COATING THICKNESS (TCT)(mm) = 0.47, COVER WIDTH (mm) = 757 | METALDEK | MS 2500:2020 |
| | Self-Supporting Steel Sheet Model: HICONDEK®40; Type: CONCEALED FIX SHEET; Size: TOTAL COATING THICKNESS (TCT)(mm) = 0.47-0.53, COVER WIDTH (mm) = 700 | HICONDEK | MS 2500:2020 |

[Restricted / Prepared for Client Only]



Prepared for
 Overseametal Sdn Bhd
 PLO 230(B), Jalan Kencana Mas 1,
 Kawasan Perindustrian Tebrau III,
 81100 Johor Bahru, Johor.

Test Report
 AL/RPT/18/04

Sheet Roof Resistance Test to Wind Pressure

| | | |
|---|--|-----------------|
| Aeronautics Laboratory Universiti Teknologi Malaysia | Prepared | Signature |
| | Abd Basid Abd Rahman Engineer | 02 MAY 2019 |
| | Checked | Signature |
| | Wan Zaidi Wan Omar Senior Lecturer | 02 MAY 2019 |
| Overseametal Sdn. Bhd. | Approved | Signature |
| | Ir. Dr. Shabudin Mat Head of Laboratory | 02 MAY 2019 |
| | Acknowledged | |



Figure 2: Test rig



Figure 3: Dial gauge position

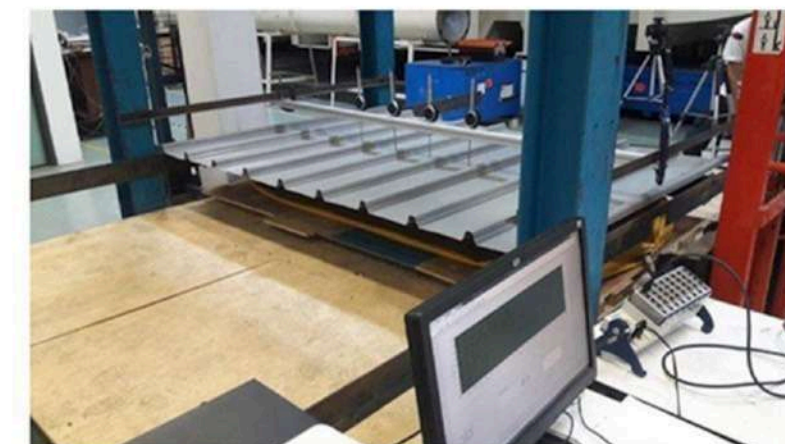

Figure 4: Airbag pressure measurement



THIS IS TO CERTIFY THAT

OVERSEAMETAL SDN BHD

WAS AWARDED

INDUSTRY PARTNER

OF THE

**MALAYSIA GREEN
BUILDING COUNCIL**

ON 1ST JANUARY 2026

In Witness Where of The Common Seal Has Been Here to Affixed
In Accordance with The Constitution
and By Authority of The Council

PRESIDENT

HONORARY SECRETARY

COUNCIL MEMBER

COUNCIL MEMBER

MEMBERSHIP NUMBER : IDP 0194

EXPIRY DATE : 31ST DECEMBER 2026

PROUD MEMBER SINCE : 7TH APRIL 2025

THIS CERTIFICATE IS THE PROPERTY OF THE MALAYSIA GREEN BUILDING COUNCIL

MyHIJAU • MARK



This is to certify that

CSC STEEL SDN. BHD. (228899P)

180
Kawasan Industri Ayer Keroh
75450 Ayer Keroh
Melaka

has the rights to use the MyHIJAU Mark on the following item:

(Refer to Schedule Page for more details)

Compliance Category:

Green Label Certification (ISO 14024 Type I ECO-Labels)

Certification Scheme:

SIRIM Eco-Labeling Scheme

Certificate no.: MyHP00461/23

Issue Date: 19-12-2024

Expiry Date: 14-11-2026



Malaysian Green Technology And Climate
Change Corporation
(462237-T)

No 2, Jalan 9/10, Persiaran Usahawan
Seksyen 9, 43650 Bandar Baru Bangi
Selangor Darul Ehsan
Malaysia

T : 603-8921 0800
F : 603-8921 0801

www.myhijau.my
www.mgtc.gov.my

This is a computer generated certificate hence no signature is required.

This certificate is granted subject to the Terms and Condition of usage of MyHIJAU Mark certificate and label.

CERTIFICATIONS



CERTIFICATE

SIRIM QAS International hereby certifies that

OVERSEAMETAL SDN. BHD.
PLO 230 (B), JALAN KENCANA MAS 2,
KAWASAN PERINDUSTRIAN TEBRAU 3,
81100 JOHOR BAHRU,
JOHOR, MALAYSIA.

has implemented a Quality Management Systems complying with

ISO 9001:2015
QUALITY MANAGEMENT SYSTEMS – REQUIREMENTS

Scope of Certification

MANUFACTURE OF METAL ROOFING AND WALL CLADDING.

Issue date : 28 June 2023
 Original certification date : 03 July 2014
 Expiry date : 02 July 2026
 Certificate no. : QMS 02739



SIRIM QAS INTERNATIONAL SDN. BHD.
 (Co. No. 199601037981 (410334-X))
 1, Persiaran Dato' Menteri
 Section 2, P.O. Box 7035
 40700 Shah Alam
 Selangor Darul Ehsan
 MALAYSIA
 Tel : 60-3-55446404
 Fax : 60-3-55446787

Nur Fadhilah Muhammad
 Chief Executive Officer
 SIRIM QAS International Sdn. Bhd.

This certificate is granted subject to the terms and conditions as stated in the Certification Agreement.



Building trust together.

Certificate

SIRIM QAS International has issued an IQNET recognized certificate that the organization:

OVERSEAMETAL SDN. BHD.

Plo 230 (B), Jalan Kencana Mas 2
 Kawasan Perindustrian Tebrau 3
 81100 Johor Bahru
 Johor Darul Takzim
 Malaysia

has implemented and maintains a
 Quality Management Systems

for the following scope:
Manufacture of metal roofing and wall cladding.

which fulfils the requirements of the following standard :

ISO 9001:2015

Issued on: 28 June 2023
 First issued on: 03 July 2014
 Expires on: 02 July 2026

Registration Number: **MY – QMS 02739**

Alex Stoichitoiu
 President of IQNET

Nur Fadhilah Muhammad
 Chief Executive Officer of
 SIRIM QAS International Sdn. Bhd.



This attestation is directly linked to the IQNET Member's original certificate and shall not be used as a stand-alone document.

IQNET Members:
 AENOR Spain AFNOR Certification France APCER Portugal CCC Cyprus CISO Italy CQC China CQM China CQS Czech Republic
 Cro Cert Croatia DOS Holding GmbH Germany EAGLE Certification Group USA FCAV Brazil FONDONORMA Venezuela ICONTEC
 Colombia ICS Bosnia and Herzegovina Inspecta Sertifointi Oy Finland INTECO Costa Rica IRAM Argentina JOA Japan KFO Korea
 LSGA Uruguay MIRTEC Greece MSZT Hungary Nemko AS Norway NSAI Ireland NYCE-SIGE Mexico PCBC Poland Quality Austria
 Austria SII Israel SIQ Slovenia SIRIM QAS International Malaysia SGS Switzerland SRAC Romania TSE Turkey YUQS Serbia

*The list of IQNET Members is valid at the time of issue of this certificate. Updated information is available under www.iqnet-certification.com

CERTIFICATIONS



No Lesen : **PC002338**
Licence No :

LESEN PENSIJILAN BARANGAN

Product Certification Licence



SIRIM QAS International Sdn. Bhd. dengan ini menganugerahkan kepada SIRIM QAS International Sdn. Bhd. hereby grants to

CSC STEEL SDN. BHD.
180 , KAWASAN INDUSTRI AYER KEROH
75450 AYER KEROH
MELAKA, MALAYSIA



Lesen untuk menggunakan Tanda Pensijilan di atas barangan
a licence to use the Certification Mark on

PREFINISHED FLAT STEEL PRODUCTS FOR INTERIOR/EXTERIOR BUILDING APPLICATIONS



Please refer to detail in the SCHEDULE

sebagai mematuhi keperluan
as complying with

MS 2383 : 2020

Ts. Md. Adha bin Katni @ Rahmat
Ketua Pegawai Eksekutif
Chief Executive Officer
SIRIM QAS International Sdn. Bhd.



SIRIM QAS International Sdn. Bhd.
((No. Syarikat 199601037981(410334-X)))

1, Persiaran Dato' Menteri
Seksyen 2, Peti Surat 7035
40700 Shah Alam
Selangor Darul Ehsan
MALAYSIA.

Tel : 603-5544 6000
Emel : cserviceqas@sirim.my

www.sirim-qas.com.my
https://www.malaysiancertified.com.my

Tarikh Mula Pensijilan : 27 May 2016

Certified Since

Sah Sehingga : 05 May 2027

Valid Until

Lesen ini dianugerahkan tertakluk kepada syarat-syarat Perjanjian Pensijilan Barangan SIRIM QAS International Sdn. Bhd.
This Licence is granted subject to the provisions of the Product Certification Agreement of SIRIM QAS International Sdn. Bhd.

Tarikh Dikeluarkan : 13 April 2026

Issue Date

No Siri : 125887

Serial No



No Lesen : **PC002338**
Licence No :

SCHEDULE

CSC STEEL SDN. BHD.



Trade Mark : realcolor
Model : MODEL = Primero;
BASE METAL QUALITY DESIGNATION = STRUCTURAL GRADE : 250, 280, 300, 320, 350, 400, 450, 550

Rating : COATING DESIGNATION = Z180, Z275;
MANUFACTURER'S PRODUCT NAME = PRE-PAINTED STEEL COIL.
Type : CORROSION CATEGORY = C4(T); GLOSS RANGE = MEDIUM, HIGH.

Size : NOMINAL TOP COAT PRIMER THICKNESS (µm)= 2 - 12;
NOMINAL TOP COAT THICKNESS (µm) = 10 - 20;
NOMINAL BACKCOAT THICKNESS (µm) = 4 - 18;
BASE METAL THICKNESS (mm) = 0.35 - 0.60;
MAXIMUM WIDTH (mm) = 1219.



Trade Mark : realcolor
Model : MODEL = Primero;
BASE METAL QUALITY DESIGNATION = COMMERCIAL GRADE : 01

Rating : COATING DESIGNATION = Z180, Z275;
MANUFACTURER'S PRODUCT NAME = PRE-PAINTED STEEL COIL.
Type : CORROSION CATEGORY = C4(T); GLOSS RANGE = MEDIUM, HIGH.

Size : NOMINAL TOP COAT PRIMER THICKNESS (µm)= 2 - 12;
NOMINAL TOP COAT THICKNESS (µm) = 10 - 20;
NOMINAL BACKCOAT THICKNESS (µm) = 4 - 18;
BASE METAL THICKNESS (mm) = 0.35 - 0.60;
MAXIMUM WIDTH (mm) = 1219.

Trade Mark : realcolor
Model : MODEL = Supreme;
BASE METAL QUALITY DESIGNATION = STRUCTURAL GRADE : 250, 280, 300, 320, 350, 400, 450, 550

Rating : COATING DESIGNATION = Z275;
MANUFACTURER'S PRODUCT NAME = PRE-PAINTED STEEL COIL.
Type : CORROSION CATEGORY = C5-I, C5-M; GLOSS RANGE = MEDIUM, HIGH.

Size : NOMINAL TOP COAT PRIMER THICKNESS (µm)= 5 - 60;
NOMINAL TOP COAT THICKNESS (µm) = 20 - 60;
NOMINAL BACKCOAT THICKNESS (µm) = 7 - 35;
BASE METAL THICKNESS (mm) = 0.42 - 0.70;
MAXIMUM WIDTH (mm) = 1219.

SIRIM QAS International Sdn. Bhd.
((No. Syarikat 199601037981(410334-X)))

1, Persiaran Dato' Menteri
Seksyen 2, Peti Surat 7035
40700 Shah Alam
Selangor Darul Ehsan
MALAYSIA.

Tel : 603-5544 6000
Emel : cserviceqas@sirim.my

www.sirim-qas.com.my
https://www.malaysiancertified.com.my

Tarikh Mula Pensijilan : 27 May 2016

Certified Since

Sah Sehingga : 05 May 2027

Valid Until

Lesen ini dianugerahkan tertakluk kepada syarat-syarat Perjanjian Pensijilan Barangan SIRIM QAS International Sdn. Bhd.
This Licence is granted subject to the provisions of the Product Certification Agreement of SIRIM QAS International Sdn. Bhd.

Tarikh Dikeluarkan : 13 April 2026

Issue Date

No Siri : 125887

Serial No



ALL RIGHTS RESERVED

OVERSEAMETAL SDN BHD (166335-V)

JOHOR BAHRU FACTORY:

No.15 PLO 230(B), Jalan Kencana Emas 2,
Kawasan Perindustrian Tebrau 3, 81100 Johor Bahru, Johor.

SELANGOR FACTORY:

No.16, Jalan P4/8, Bandar Teknologi Kajang,
43500 Semenyih, Selangor Darul Ehsan.

Tel: 07-3576333

www.overseametal.com