

Pressure Accessories - 3 way Pressure Cock Valves

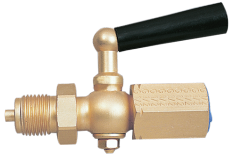

Usage Properties

Operating Pressure (max.)	· 64 bar
Operating Temperature	· +50°C
Storage Temperature	· -40 ... +70 °C

Constructive Properties

Case	· Brass
Inlet Connections	· G 1/2"
Outlet Connections	· G 1/2"
Max.Pressure	· PN64

Technical Drawings - 3 way Pressure Cock Valves

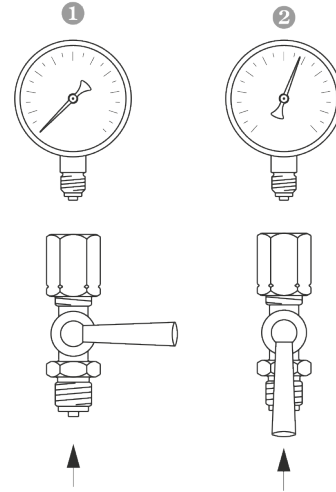
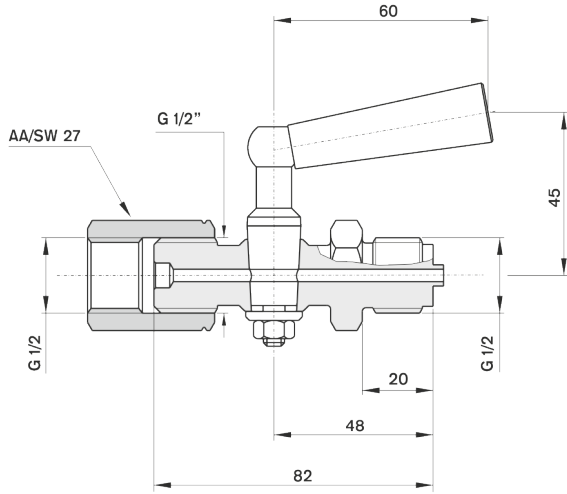

1042 25 /