

Temperature and filling level sensor

Original operating manual

Series with
Modbus[®] RTU interface
HFT MD
HFT MD Flex



Version BA-2016.11.28 EN
Print-No. 300 274
TR MA DE Rev002

ASV Stübbe GmbH & Co. KG
Hollwieser Straße 5
32602 Vlotho
Germany
Phone: +49 (0) 5733-799-0
Fax: +49 (0) 5733-799-5000
E-mail: contact@asv-stuebbe.de
Internet: www.asv-stuebbe.com



We reserve the right to make technical changes.

Read carefully before use.
Save for future use.

Table of contents

1	About this document	4	7.4.1	Selecting relay output	14
1.1	Target groups	4	7.4.2	Setting	14
1.2	Other applicable documents	4	7.5	Display menu	15
1.3	Warnings and symbols	4	7.6	Diagnostics menu	15
2	General safety instructions	5	7.7	Service menu	16
2.1	Intended use	5	8	Maintenance	17
2.2	General safety instructions	5	8.1	Servicing	17
2.2.1	Obligations of the operating company	5	8.2	Maintenance	17
2.2.2	Obligations of personnel	5	8.2.1	Removing the device	17
2.3	Specific hazards	5	8.2.2	Replacement parts and return	17
2.3.1	Hazardous media	5	9	Troubleshooting	18
3	Layout and Function	6	9.1	Troubleshooting	19
3.1	Name plate	6	9.1.1	Fixingsoftware loading errors	19
3.2	Description	6	10	Appendix	20
3.3	Layout	6	10.1	Technical specifications	20
3.3.1	Compact	6	10.2	Dimensions	20
3.3.2	Flex	7	10.3	Accessories	20
3.3.3	UNI display	7	10.4	Modbus RTU connection plan	20
3.3.4	Measured value display	7	10.5	Modbus RTU termination	21
4	Transport, Storage and Disposal	8	10.5.1	Termination for one device	21
4.1	Unpacking and inspection on delivery	8	10.5.2	Termination for several devices	21
4.2	Transportation	8	10.6	Pin assignment on sensor cable	22
4.3	Storage	8	10.7	Modbus functions	22
4.4	Disposal	8	10.8	Modbus RTU message formats	23
5	Installation and connection	9			
5.1	Check operating conditions	9			
5.2	Install device	9			
5.2.1	Installing Compact version	9			
5.2.2	Installing Flex version	9			
5.3	Electrical connection of device	10			
6	Operation	11			
6.1	Basic operation using the UNI display	11			
6.1.1	Measured value display	11			
6.1.2	Parameterizing	11			
6.2	Initial start-up with UNI display	12			
6.3	Managing several devices	12			
6.3.1	Backing up parameter sets	12			
6.3.2	Parameterizing several devices	12			
6.4	Reading the data logger	12			
6.5	Updating firmware	12			
7	Menus and functions	13			
7.1	Measured value display	13			
7.2	Main menu	13			
7.3	Basic settings menu	13			
7.4	Output menu	14			

List of figures

Fig. 1	Name plate	6
Fig. 2	Housing and compact sensor layout	6
Fig. 3	Housing and flex sensor layout	7
Fig. 4	UNI display layout	7
Fig. 5	Display of measured values	7
Fig. 6	UNI display	11
Fig. 7	Modbus RTU connection plan	20
Fig. 8	Pin assignment for the Flex version	22

List of tables

Tab. 1	Other application documents, purpose and where found	4
Tab. 2	Warnings and symbols	4
Tab. 3	Button functions with measured value display	11
Tab. 4	Button functions when parameterizing	11
Tab. 5	Button function with measured value display	13
Tab. 6	Main menu	13
Tab. 7	Basic settings menu	14
Tab. 8	Output menu (relay)	14
Tab. 9	Output menu	15
Tab. 10	Display menu	15
Tab. 11	Diagnostics menu	15
Tab. 12	Data logger settings	15
Tab. 13	Service menu	16
Tab. 14	Servicing activities	17
Tab. 15	Troubleshooting	18
Tab. 16	Troubleshooting	18
Tab. 17	Accessories	20
Tab. 18	Modbus RTU terminal allocation	20
Tab. 19	Modbus functions	22
Tab. 20	Modbus RTU Message Formats	23

1 About this document

This manual

- is part of the equipment
- applies to all series referred to
- describes safe and proper operation during all operating phases

1.1 Target groups

Operating company

- Responsibilities:
 - Always keep this manual accessible where the device is used on the system.
 - Ensure that employees read and observe this document, particularly the safety instructions and warnings, and the documents which also apply.
 - Observe any additional country-specific rules and regulations that relate to the system.

Qualified personnel, fitter







- Mechanics qualification:
 - Qualified employees with additional training for fitting the respective pipework.
- Electrical qualification:
 - Qualified electrician
- Transport qualification:
 - Qualified transport specialist
- Responsibility:
 - Read, observe and follow this manual and the other applicable documents, especially all safety instructions and warnings.

1.2 Other applicable documents

To download: Data sheet Technical specifications, conditions of operation www.asv-stuebbe.de/pdf_datasheets/300068.pdf	
To download: Resistance lists Resistance of materials used to chemicals www.asv-stuebbe.de/pdf_resistance/300051.pdf	
To download: CE declaration of conformity Conformity with standards www.asv-stuebbe.de/pdf_DOC/300073.pdf	

Tab. 1 Other application documents, purpose and where found

1.3 Warnings and symbols

Symbol	Meaning
	<ul style="list-style-type: none"> • Immediate acute risk • Death, serious bodily harm
	<ul style="list-style-type: none"> • Potentially acute risk • Death, serious bodily harm
	<ul style="list-style-type: none"> • Potentially hazardous situation • Minor injury
	<ul style="list-style-type: none"> • Potentially hazardous situation • Material damage
	Safety warning sign ► Take note of all information highlighted by the safety warning sign and follow the instructions to avoid injury or death.
	Instruction
1., 2., ...	Multiple-step instructions
✓	Precondition
→	Cross reference
	Information, notes

Tab. 2 Warnings and symbols

2 General safety instructions

 The manufacturer accepts no liability for damages caused by disregarding any of the documentation.

2.1 Intended use

The device measures or monitors filling level and temperature in a liquid medium. The relay version switches off a consuming unit (e.g. pump) if limit values are exceeded or not achieved. The limit values are adjustable.

- The device must only be used for monitoring filling level and temperature in liquid media.
- Only use the device with suitable media (→ resistance lists).
- Adhere to the operating limits (→ [10.1 Technical specifications, Page 20](#)).

2.2 General safety instructions

 Observe the following regulations before carrying out any work.

2.2.1 Obligations of the operating company

Safety-conscious operation

- Only operate the device if it is in perfect technical condition and only use it as intended, staying aware of safety and risks, and in adherence to the instructions in this manual.
- Ensure that the following safety aspects are observed and monitored:
 - Intended use
 - Statutory or other safety and accident-prevention regulations
 - Safety regulations governing the handling of hazardous substances
 - Applicable standards and guidelines in the country where the pump is operated
- Make personal protective equipment available.

Qualified personnel

- Make sure all personnel tasked with work on the device have read and understood this manual and all other applicable documents, especially the safety, maintenance and repair information, before they start any work.
- Organize responsibilities, areas of competence and the supervision of personnel.
- The following work should be carried out by specialist technicians only:
 - Installation, repair and maintenance work
 - Work on the electrical system
- Make sure that trainee personnel only work on the device under supervision of specialist technicians.

2.2.2 Obligations of personnel

Only complete work on the device if the following requirements are met:

- System is empty
- System has been flushed
- System is depressurized
- System has cooled down
- System is secured against being switched back on again
- Do not make any modifications to the device.

2.3 Specific hazards

2.3.1 Hazardous media

- When handling hazardous media, observe the safety regulations for the handling of hazardous substances.
- Use personal protective equipment when carrying out any work on the device.
- Collect leaking pumped liquid and residues in a safe manner and dispose of in accordance with environmental regulations.

3 Layout and Function

3.1 Name plate

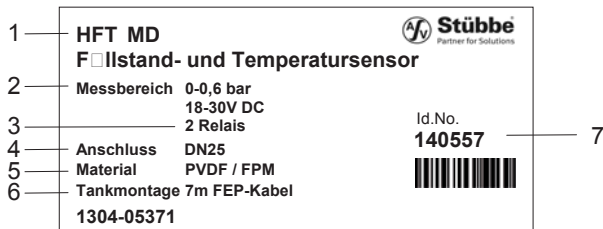

Fig. 1 Name plate

- 1 Device type
- 2 Filling level measurement range
- 3 Outlet
- 4 Connection (nominal width)
- 5 Media connection and gasket material
- 6 Installation type
- 7 ID number

Device types

- HFT R – Compact, relay output
- HFT Flex R – Flex, relay output
- HFT C4 – Compact, current output
- HFT C4 Flex – Flex, current output

3.2 Description

The device measures or monitors filling level and temperature in a liquid medium. The relay version switches off a consuming unit (e.g. pump) if limit values are exceeded or not achieved. The limit values are adjustable.

The device is integrated within the control of the consuming unit using the following inputs and outputs:

- 2 relay outputs (changeover contact, SPDT)
Control via limit values or Modbus
- 2 optically isolated inputs (optocoupler) for reading the status of the inputs via the Modbus
- Modbus RS485 interface
The Modbus RTU is a popular data exchange format. Devices with an RTU RS485 interface can be connected to one another and communicate with a master device.

Versions available:

- Compact
 - Compact housing
 - Process connection directly under the connection housing
 - Installation in the pipe
- Flex
 - Connection and sensor housing firmly connected to one another
 - Process connection linked to the connection housing via cable
 - Installation from above into a tank or container

The UNI display (optional) shows measured value. It can be used for all measuring instruments of the UNI display device platform PTM, HFT and UFM and offers the following additional functions:

- Graphic filling level display
- Displays status of the relay outputs
- Menu-guided device setting
- Data logger function with date stamp
- Saving and transfer of parameter settings to other sensors
- Memory function on microSD card
- Firmware update

3.3 Layout

3.3.1 Compact

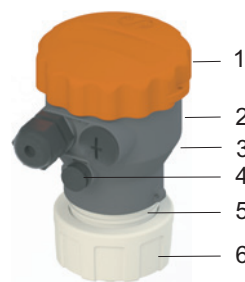

Fig. 2 Housing and compact sensor layout

- 1 Housing cover
- 2 Connection housing
- 3 Cable glands
- 4 Pressure compensation valve
- 5 Sensor housing
- 6 Process connection

3.3.2 Flex

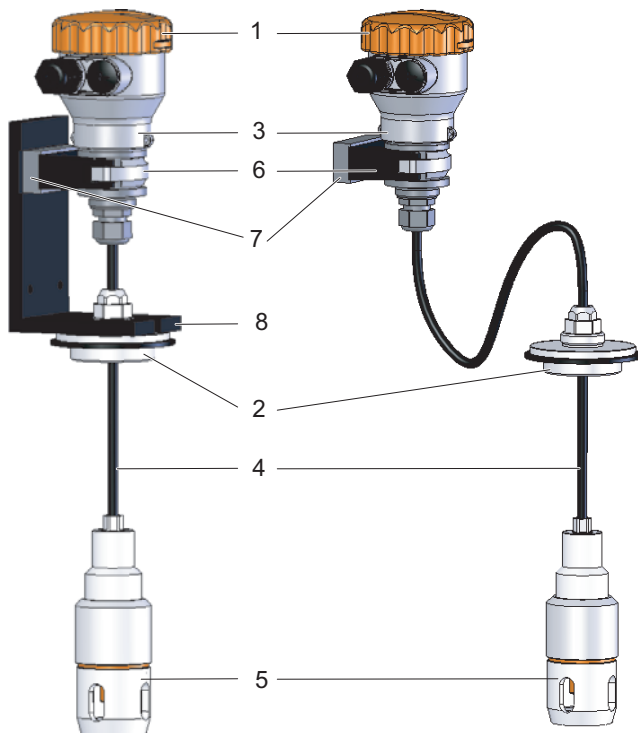

Fig. 3 Housing and flex sensor layout

- 1 Housing cover
- 2 Cable gland
- 3 Connection housing
- 4 Sensor cable
- 5 Sensor
- 6 Pipe clamp
- 7 Spacer
- 8 Support bracket from wall mount installation kit

3.3.3 UNI display

The UNI display is fitted on to the connection housing (remove housing cover). The transparent cover supplied allows the measured values to be read during operation.

The device can be adjusted and put into operation using the UNI display.

The UNI display can be removed again once it has been put into operation. The UNI display remains attached if the intention is to display measured values permanently.

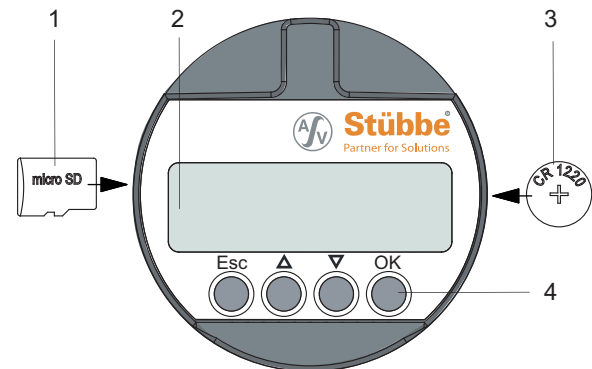

Fig. 4 UNI display layout

- 1 microSD card (with spring ejection)
- 2 Display
- 3 Battery
- 4 Operating buttons

3.3.4 Measured value display

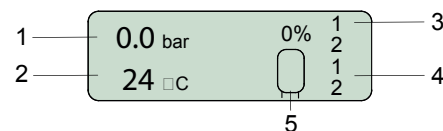

Fig. 5 Display of measured values

- 1 Pressure display (absolute and as a percentage)
- 2 Temperature display
- 3 Relay status display
Normal display = contact open
Inverted display = contact closed
- 4 Input status display
Normal display = switch on input open
Inverted display = switch on input closed
- 5 Graphical filling level display

4 Transport, Storage and Disposal

4.1 Unpacking and inspection on delivery

1. Unpack the device when received and inspect it for transport damage and completeness.
2. Check that the information on the type plate agrees with the order/design data.
3. Report any transport damage to the manufacturer immediately.
4. If fitted immediately: Dispose of packaging material according to local regulations.
 - If fitted at a later point: leave device in its original packaging.

4.2 Transportation

- ▶ Device should preferably be transported in the original packaging.

4.3 Storage

NOTE

Material damage due to inappropriate storage!

- ▶ Store the device properly.
1. Make sure the storage room meets the following conditions:
 - Dry
 - Frost-free
 - Vibration-free
 - Not in direct sunlight
 - Storage temperature +10 °C to +60 °C
 2. Device should preferably be stored in the original packaging.

4.4 Disposal

- ⓘ Plastic parts can be contaminated by poisonous or radioactive media to such an extent that cleaning will not be sufficient.

 **WARNING**

Risk of poisoning and environmental damage from medium.

- ▶ Use personal protective equipment when carrying out any work on the device.
- ▶ Prior to the disposal of the device: Neutralize residues of medium in the device.

-
1. Remove battery and dispose of in accordance with local regulations.
 2. Remove electronic parts and dispose of in accordance with local regulations.
 3. Dispose of plastic parts in accordance with local regulations.

5 Installation and connection

5.1 Check operating conditions

1. Ensure the required operating conditions are met:
 - Resistance of body and seal material to the medium (→ resistance lists).
 - Media temperature (→ 10.1 Technical specifications, Page 20).
 - Working pressure (→ 10.1 Technical specifications, Page 20).
2. Consult with the manufacturer regarding any other use of the device.

5.2 Install device

5.2.1 Installing Compact version

- ✓ Process pipework has been properly prepared.
- ✓ Process pipework has been secured against unintentional opening with shut-off valves.

 Avoidance of medium buildup.
 Select installation location so that no build-up or crystallization is possible.

WARNING

Risk of injury and poisoning due to medium spraying out.

- ▶ Use personal protective equipment when carrying out any work on the fitting.

1. Unscrew union nut.
2. Insert union nut on to the spool piece of the process pipework.
Check mounting direction.
3. Weld device insert to the process pipework spool piece.
4. Check O-ring fitting.
5. Connect device to the process pipework. Tighten union nut by hand only.

5.2.2 Installing Flex version

- ✓ Tank has been properly prepared.

 Avoidance of medium buildup.
 Select installation location so that no build-up or crystallization is possible.

 Lateral movements of sensors lead to measurement errors. Fit protection tube or use additional weight if necessary (→ 10.3 Accessories, Page 20).
 Select installation location so that no build-up or crystallization is possible.

WARNING

Risk of injury and poisoning due to medium spraying out.

- ▶ Use personal protective equipment when carrying out any work on the fitting.

1. Mount support bracket, if available.
2. Attach sensor housing in the support bracket.
3. Guide the sensor into the tank from above and lower to the base of the tank.
 - The sensor must not touch the base of the tank.
4. Screw the cable gland tight.

5.3 Electrical connection of device

- ✓ Device is connected to the process pipework.
- ✓ Power supply is switched off and secured against being switched back on again.

 Cable without shielding can be used to connect the device. If electromagnetic interference is anticipated, then use shielded cable.
Terminal strips are pluggable.

DANGER

Risk of electrocution

- ▶ All electrical work must be carried out by qualified electricians only.
- ▶ Switch off system power supply and secure it against being switched back on again.

1. Unscrew the housing cover from the connection housing, remove UNI display if required.
2. Guide the connection cable through the cable glands and connect:
 - Cables (→ Data sheet).
 - Connection diagram (→ [10.4 Modbus RTU connection plan, Page 20](#)).
3. Tighten the cable glands securely.
4. Insert jumper
 - If the bus cable ends at this device, plug jumper on to “ON”
 - If the bus cable does not end at this device or is extended, plug jumper on to “OFF”
(→ [10.5 Modbus RTU termination, Page 21](#)).
5. Screw on the housing cover.
6. Use earthed Modbus power supply (power supply unit with PE connection).

6 Operation

NOTE

Changing parameters affects the switching outputs immediately.

- ▶ Make sure that changing a parameter does not trigger a malfunction (e.g. a pump running dry).

i When switching on the device, all relay contacts are open for 3 s (NO).

After this the relay contacts assume the status which corresponds with the setting and the measured values.

6.1 Basic operation using the UNI display

i Description of menus and functions
(→ 7.2 Main menu, Page 13).

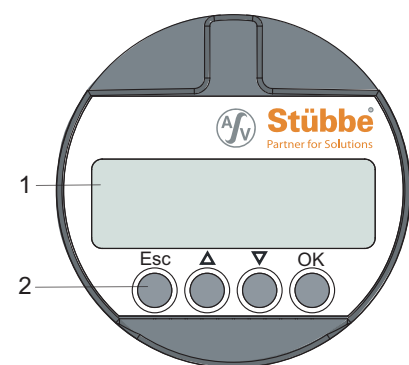

Fig. 6 UNI display

- 1 Display
- 2 Operating buttons

6.1.1 Measured value display

The display shows the measured value.

Button	Function
OK	Main menu
Esc	Switches measured value display to time and date view.
▲ ▼ simultaneously	Changes the display direction.

Tab. 3 Button functions with measured value display

6.1.2 Parameterizing

Button	Functions
Esc	<ul style="list-style-type: none"> • Cancels input and switches to the higher-level menu. • Changes will not be saved.
▲	<ul style="list-style-type: none"> • Increases parameter value. • Previous menu/submenu • Press and hold to increase parameter value quickly. • Press ▼ at the same time to increase parameter value very quickly.
▼	<ul style="list-style-type: none"> • Reduces parameter value. • Previous menu/submenu. • Press and hold to reduce parameter value quickly. • Press ▲ at the same time to reduce parameter value very quickly.
OK	<ul style="list-style-type: none"> • Switches to the menu overview. • Switches to the menu/submenu selected. • Confirms parameter and saves value.
If no button is pressed	<ul style="list-style-type: none"> • The measured values are displayed after 2 minutes. • Changes will not be saved.

Tab. 4 Button functions when parameterizing

6.2 Initial start-up with UNI display

 The UNI display can be removed again once it has been put into operation.

The UNI display remains attached if the intention is to display measured values permanently.

If the display is upside down, press ▲ ▼ buttons simultaneously.

- ✓ Device is installed properly.
 - ✓ Device is connected properly with the power supply and ready for operation.
1. Unscrew the housing cover.
 2. Insert UNI display on to the electronic equipment (white plug-in location).
 3. Configure device (→ 7.2 Main menu, Page 13).
 4. Remove UNI display if necessary.
 5. Screw on housing cover or transparent cover.

6.3 Managing several devices

 Using the UNI display and microSD card, parameter sets can be transferred between devices or archived on a PC.

 All microSD cards or microSDHC cards with FAT32 formatting are supported. Files must be maintained in the master directory.

Files should be named in Format 8.3 (e.g. PARA_1.ASV), otherwise only an abbreviated file name is displayed.

The memory function always names the files STUEBBE.ASV. If a STUEBBE.ASV file already exists on the microSD card, then this file is overwritten.

6.3.1 Backing up parameter sets

1. Save the parameter set from the device on to the microSD card (→ 7.7 Service menu, Page 16).
2. Insert the microSD card into the PC, then transfer and archive the STUEBBE.ASV file.

6.3.2 Parameterizing several devices

1. Parameterize the first device (→ 7.2 Main menu, Page 13).
2. Save the parameter set from the device on to the microSD card (→ 7.7 Service menu, Page 16).
3. Attach the UNI display, with the microSD cards inserted, on to the next device.
4. Save the parameter set from the microSD card on to the device (→ 7.7 Service menu, Page 16).

6.4 Reading the data logger

 Series of measurements can be created and read using the UNI display and microSD card.

1. Insert the microSD card in a UNI display and attach the UNI display to the device.
2. Set up the data logger function (→ 7.6 Diagnostics menu, Page 15).
3. Remove the microSD card and read the log file (csv format) on the PC.

6.5 Updating firmware

 Current sensor firmware or UNI display firmware can be obtained via the Internet (→ www.asv-stuebbe.com/service/downloads).



In the event that the updating is interrupted (→ 9.1.1 Fixing software loading errors, Page 19).

1. Download the latest version of the sensor firmware (e. g. HFT_Vxxx.HEX) and UNI display firmware (UNI_Vxxx.HEX) from the Internet and save on the microSD card.
2. Insert the microSD card in a UNI display and attach the UNI display to the device.
3. Save sensor firmware or UNI display firmware from the microSD card on to the device (→ 7.7 Service menu, Page 16).
4. Observe release notes. If “reset factory settings” is necessary:
 - Note all parameters.
 - Perform “reset factory settings” (→ 7.2 Main menu, Page 13).
 - Reset the device (→ 7.7 Service menu, Page 16).
5. Check date and time, and reset if necessary (→ 7.3 Basic settings menu, Page 13).

7 Menus and functions

7.1 Measured value display

The display shows the measured value.

Button	Function
OK	Main menu
Esc	Switches measured value display to time and date view.
▲ ▼ simultaneously	Changes the display direction.

Tab. 5 Button function with measured value display

7.2 Main menu

Main menu	Function
Basic settings	Performs basic settings (→ 7.3 Basic settings menu, Page 13).
Outlet	Adjusts the behavior of the outputs (→ 7.4 Output menu, Page 14).
Display	Sets the display options (→ 7.5 Display menu, Page 15).
Diagnostics	Checks the diagnostics functions (→ 7.6 Diagnostics menu, Page 15).
Service	Performs the service functions (→ 7.7 Service menu, Page 16).

Tab. 6 Main menu

7.3 Basic settings menu

Submenu values	Function
Language	
German English French Spanish Italian	Sets the operating language
Lighting	
Automatic	The display lighting switches on automatically for 15 seconds: <ul style="list-style-type: none"> if the display value of the pressure changes by 5% if there is a temperature change of > 5 K
using any button	The display lighting switches on for 15 s each time a button is pressed.
off	Display lighting is always off.
on	Display lighting is always on.

Submenu values	Function
Integration time	
0 ... 60 s	Sets the measurement interval for the pressure sensor. An average is calculated and displayed using the measurement interval. This removes the effect of short-term pressure fluctuations. A long integration time delays the reaction to pressure fluctuations.
Calibration	
Basic correction	The current pressure is set as the reference pressure (0 bar). All other measures then refer to this reference pressure.
min. calibration	Setting % display pressure. The value set is displayed as "0 %": ▶ ▲ ▼ – sets pressure value for 0 % ▶ OK – accepts setting
max. calibration	Setting % display pressure. The value set is displayed as "100 %": ▶ ▲ ▼ – sets pressure value for 100 % ▶ OK – accepts setting
Specific gravity of medium	
xxxx.yyy kg/m ³	▶ ▲ ▼ – sets the specific gravity of medium to be measured. ▶ OK – accepts setting
Volume expansion	
xxx.y 10 ⁻⁵ /K	▶ ▲ ▼ – sets heat-related volume expansion of medium to be measured. ▶ OK – accepts setting
Tank volume	
xx.y m ³ xxxxx l	▶ ▲ ▼ – sets volume of tank to be measured ▶ OK – accepts setting
xxxx mm	▶ ▲ ▼ – sets tank height. ▶ OK – accepts setting
100%	▶ ▲ ▼ – tank height = 100 % (yes/no). ▶ OK – accepts setting

Submenu values	Function
Container shape	
Linear Spherical tank Horizontal tank	<ul style="list-style-type: none"> ▶ ▲▼ – sets tank shape. ▶ OK – accepts setting ▶ ▲▼ – sets number of tanks (1 ... 5) for accumulation tanks. ▶ OK – accepts setting
Time	
DD.MM.YYYY HH:MM	Display/setting of date and time. The first position in the date is underlined. <ul style="list-style-type: none"> ▶ ▲▼ – adjusts value ▶ OK – accepts value and sets next position ▶ After setting minutes, OK returns you to the basic settings menu
Modbus settings	
Interface	Setting baud rate.
All bus participants must have the same settings for baud rate / parity	<ul style="list-style-type: none"> ▶ ▲▼ – selects value between 2400 and 38400. ▶ OK – accepts setting
	Setting parity Same parity 1 stop bit No parity 2 stop bits
Address	Setting slave address
All bus participants must have different addresses	The first position in the address is underlined. <ul style="list-style-type: none"> ▶ ▲▼ – selects value between 1 and 247. ▶ OK – accept value and set next position. ▶ After setting the last number, OK returns you to the basic settings menu.

Tab. 7 Basic settings menu

7.4 Output menu

7.4.1 Selecting relay output

-  The relay output is set first, and then the switch type. The switch behavior can then be set depending on the switch type selected. Both relay outputs are set in the same way.

Submenu values	Function
Relay 1 Relay 2	<ul style="list-style-type: none"> ▶ ▲▼ – selects relay to be set The set values are displayed.

Tab. 8 Output menu (relay)

7.4.2 Setting

Submenu values	Function
Switch type	
Pressure Filling height Volume Temperature	Sets switch type: <ul style="list-style-type: none"> • Switches on / off with a change of ...
Switching point 1	
	Set switching point 1 (pressure, filling level, volume, temperature). In window mode, the value for switching point 1 must always be above the value for switching point 2.
Switch delay 1	
0 ... 60 s	Sets the switch delay for switching point 1. The switch delay is the period after which the relay switches once a switching point has been reached. The switch delay prevents, for example, the relay from rattling in hysteresis mode.
Switching point 2	
	As for switching point 1
Switch delay 2	
0 – 60 s	As for switch delay 1

Submenu values	Function
Opener/Closer	
NO NC	Sets switch function: <ul style="list-style-type: none"> • NO – closer • NC – opener <p>The relay outputs do not assume the switch function set here until approximately 3 seconds after switching on.</p>
Mode	
Hysteresis Window	Sets mode: <ul style="list-style-type: none"> • Hysteresis <ul style="list-style-type: none"> – Switches on when pressure/temperature increases at switch 1 – Switches off when pressure/temperature falls at switch 2 • Window <ul style="list-style-type: none"> – Switches on between switching point 1 and switching point 2 – Switches off under switching point 1 or over switching point 2

Tab. 9 Output menu

7.5 Display menu

Submenu values	Function
Pressure Filling height Volume Temperature	Setting the reference value and unit for the filing level display: <ul style="list-style-type: none"> ▶ ▲▼ – selects the reference value. ▶ Press OK; this will open the selection submenu for the respective unit. ▶ ▲▼ – selects the unit. ▶ OK – accepts setting

Tab. 10 Display menu

7.6 Diagnostics menu

 The data logger functions requires a microSD card. The data logger function saves the data in CSV format on the microSD card.

After the adjustable recording duration (per file) has expired, a new file is written until the microSD card is full or the data logger function is deactivated.

Submenu values	Function
Slave pointer	
Pressure	Displays minimum and maximum measured values for pressure
Temperature	Displays minimum and maximum measured values for temperature
	Reset slave point via Service – Reset – Slave pointer
Status	
Sensor OK	No error message, device functions normally.
Exxx	Error message (→ Table 15 Troubleshooting, Page 18).
Data logger	
off	Data logger function switched off.
Hour, day, month, year	Sets the recording duration for the data logger function. Measurement interval and file name correspond to the following table.

Tab. 11 Diagnostics menu

Recording duration (per file)	Measurement interval	File name
Hour	5 s	monthdayhour.csv e.g 061814.csv
Day	2 min	yearmonthday e.g 20140618.csv
Month	1 h	yearmonth.csv e.g 201406.csv
Year	1.8 h	year.csv e.g 2014.csv

Tab. 12 Data logger settings

7.7 Service menu

-  The UNI display supports all microSD or microSDHC cards with FAT32 formatting. Relevant file must be maintained in the master directory.
- If transmission errors occur when loading a parameter set, then the UNI display will restore its factory settings.
- The UNI display only displays files in 8.3 format.

Submenu values	Function
Reset	
Factory settings	Resets all parameters to the delivery state: ▶ OK – Delivery state is set.
Slave pointer	Resets slave pointer.
Info	
	Displays version of sensor firmware and UNI display firmware.
Memory	
to intermediate memory	Saves all parameters from the device on to the intermediate memory.
from intermediate memory	Saves all parameters from the intermediate memory on to the device.
to microSD card	Saves all parameters from the device on to the microSD card.
from the microSD card	Saves all parameters from the microSD card on to the device.
Update firmware	
firmware update for device	Load sensor firmware from the microSD card: ▶ Press and hold OK until “Bootloader” is displayed. ▶ Press OK - to list the existing files on the microSD card. ▶ ▲▼ – Selects file (e. g. HFT_Vxxx.HEX). ▶ OK – the new firmware is loaded into the device and immediately started.
UniDisplay	Load UNI display firmware from the microSD card: ▶ Press and hold OK + Esc until “UNIBOOT” is displayed. ▶ Press OK - to list the existing files on the microSD card. ▶ ▲▼ – Selects file (UNI_Vxxx.HEX). ▶ OK – the new firmware is loaded into the device and immediately started.

Tab. 13 Service menu

8 Maintenance

⚠ DANGER

Risk of electrocution!

- ▶ All electrical work must be carried out by qualified electricians only.

⚠ WARNING

Risk of injury and poisoning due to hazardous or hot media.

- ▶ Use personal protective equipment when carrying out any work on the device.
- ▶ Allow device to cool.
- ▶ Make sure the device is depressurized.
- ▶ Block the media supply to the device.
- ▶ Empty the pipe and safely collect the media. Dispose of it in accordance with environmental regulations.
- ▶ Switch off the power supply to the system.
- ▶ Secure power supply against being switched back on again.
- ▶ Provide warning of maintenance and repair work and set up warning signs.

8.1 Servicing

Interval	Action
As necessary	<ul style="list-style-type: none"> • Clean device with a damp cloth.
Six-monthly	Visual and function check: <ul style="list-style-type: none"> • Normal operating conditions unchanged • No leaks • No unusual operating noises or vibrations
Yearly	<ul style="list-style-type: none"> • Replace UNI display battery.

Tab. 14 Servicing activities

- ▶ Perform maintenance tasks according to the table.

8.2 Maintenance

8.2.1 Removing the device

- ✓ System is empty.
 - ✓ System has been flushed.
 - ✓ System is depressurized.
 - ✓ System has cooled down.
 - ✓ System is secured against being switched back on again.
1. Unscrew the housing cover from the connection housing, remove UNI display if required.
 2. Disconnect connection cable.
 3. Screw on the housing cover.
 4. Disassemble device from the process pipework.
 5. Decontaminate device if required.

8.2.2 Replacement parts and return

1. Have the following information ready to hand when ordering spare parts (→ 3.1 Name plate, Page 6).
 - Device type
 - ID number
 - Nominal pressure and diameter
 - Connection and gasket material
2. Please complete and enclose the document of compliance for returns (→ www.asv-stuebbe.com/service/downloads).



3. Only use spare parts from ASV Stübbe.

9 Troubleshooting

⚠ WARNING

Risk of injury and poisoning due to hazardous media liquids!

- ▶ Use personal protective equipment when carrying out any work on the device.

Error	Possible cause	Corrective action
Medium is leaking out of the flange	Pre-tension of the O-ring too small	▶ Retighten union nut by hand.
“Display Vx.yy UNI” displayed	Error occurred when updating firmware	▶ Reload firmware (→ 9.1.1 Fixingsoftware loading errors, Page 19).
“E002 – no sensor” displayed	Cable connection to the sensor defective (only with Flex version)	▶ Check sensor cable (→ 10.6 Pin assignment on sensor cable, Page 22). ▶ Replace sensor cable.
	Sensor defective	▶ Replace device (for Compact version). ▶ Replace sensor housing (for Flex version).
“RANGE” displayed	Volume calculation not possible	▶ Check settings ¹⁾ and correct if necessary (→ 7.3 Basic settings menu, Page 13).
Display remains dark	Faulty power supply	▶ Ensure power supply is present.
	Wrong version of UNI display firmware	▶ Reload firmware (→ 9.1.1 Fixingsoftware loading errors, Page 19).
Display is upside down	Wrong display direction	▶ Press ▲ ▼ buttons simultaneously to change display direction.

Tab. 15 Troubleshooting

1) Specific gravity of medium, volume expansion. Tank volume and container form

Modbus errors	Possible cause	Corrective action
Faulty/instable data transfer	Bus participants have the same address	▶ Specify different addresses for each bus participant (→ 7.3 Basic settings menu, Page 13).
	Bus participants have different baud rates/parities	▶ Set the same baud rate and parity for all bus participants (→ 7.3 Basic settings menu, Page 13).
	Modbus is incorrectly terminated	▶ Terminate Modbus correctly with jumper (→ 5.3 Electrical connection of device, Page 10).

Tab. 16 Troubleshooting

9.1 Troubleshooting

9.1.1 Fixingsoftware loading errors

 If an error occurs when updating the sensor firmware or the UNI display firmware (e.g. power failure), it may not be possible to call up the “Update firmware” menu.

 The latest sensor firmware or UNI display firmware is available on the Internet
(→ www.asv-stuebbe.com/service/downloads).



1. Save latest sensor firmware (e. g. HFT_Vxxx.HEX) or UNI display firmware (UNI_Vxxx.HEX) on to a microSD card.
2. Disconnect device from the power supply.
3. Insert UNI display and microSD card with current firmware where necessary.
4. Press hold OK in order to load the sensor firmware.
5. Press hold OK and ESC in order to load the UNI display firmware.
6. Switch on power supply.
7. OK, ▲▼ – Selects file.
8. Press OK.
The latest firmware is loaded.
9. Press “OK” again.
The latest firmware is launched.
10. Set the device again (→ [7.2 Main menu, Page 13](#)).

10 Appendix

10.1 Technical specifications

Technical data (→ Data sheet).

10.2 Dimensions

Dimensions (→ Data sheet).

10.3 Accessories

Description	Ident. number
UNI display	144153
<ul style="list-style-type: none"> • Display and control unit • with PA transparent cover for the connection housing • Languages: DE, EN, FR, ES, IT 	
Battery, CR1220, 3 V	144328
Memory card, microSD	144329
Additional weight PVDF, 0.6 kg	139785
PE installation kit for connection 1" incl. support bracket, pipe clamp and distance piece	140727

Tab. 17 Accessories

10.4 Modbus RTU connection plan

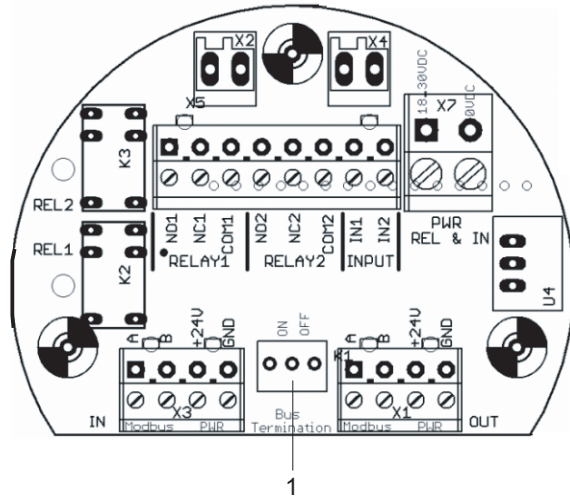

Fig. 7 Modbus RTU connection plan

1 Bus termination

Terminal allocation

Terminal strip	Terminal	Connection
X 1	A	RS485 A
	B	RS485 B
	+24V	Modus power supply
	GND	Power supply earth
X 3	A	RS485 A
	B	RS485 B
	+24V	Modus power supply
	GND	Power supply earth
X5	NO1	Relay 1 switch output closer
	NC1	Relay 1 switch output opener
	COM1	Relay 1 COM
	NO2	Relay 2 switch output closer
	NC2	Relay 2 switch output opener
	COM2	Relay 2 COM
	IN1	Start button
	IN2	Stop button
X7	18 ... 30 VDC	Power supply (18 ... 30 VDC)
	0 VDC	Reference potential for the inputs

Tab. 18 Modbus RTU terminal allocation

10.5 Modbus RTU termination

The Modbus RS485 must be terminated for devices which are at the end of the bus cable.

10.5.1 Termination for one device

Plug the jumper on to the left and center pin (Position ON).

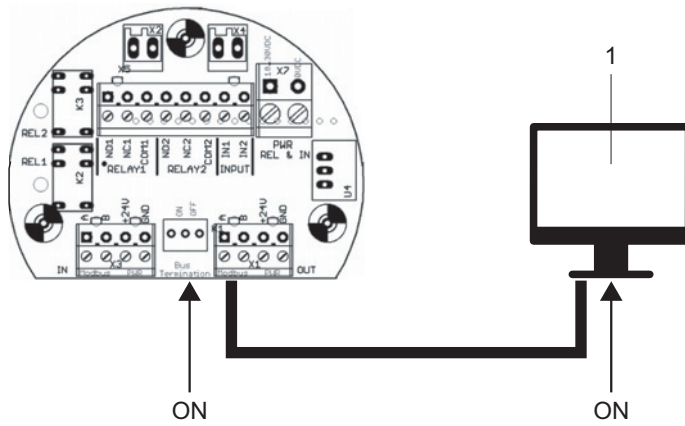

1 Master device/PWR

10.5.2 Termination for several devices

Plug the jumper on to the center and right pin (Position OFF).

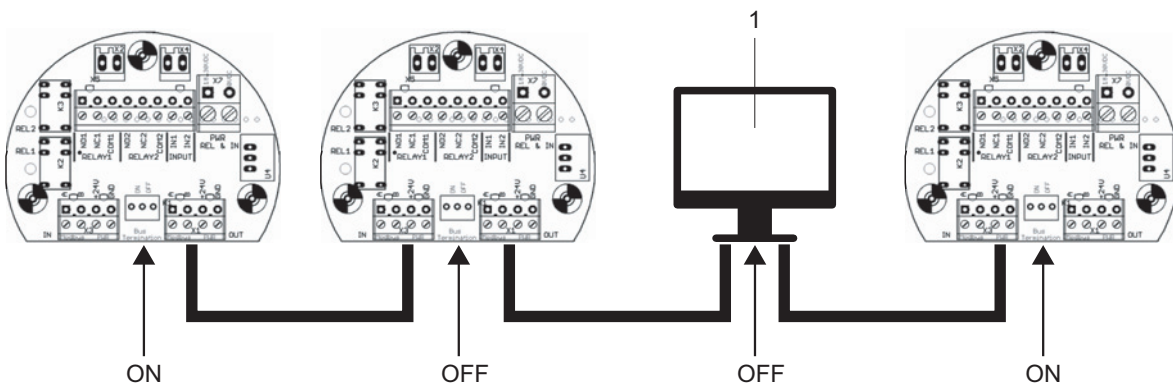

1 Master device/PWR

10.6 Pin assignment on sensor cable

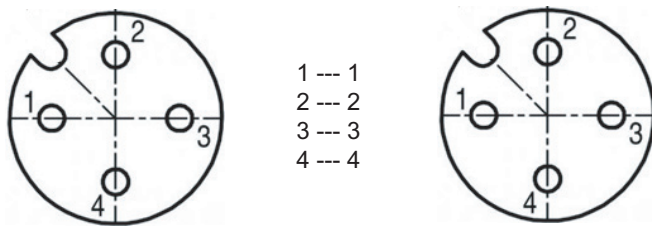

Fig. 8 Pin assignment for the Flex version

10.7 Modbus functions

Function Code	Name	Address ¹⁾	Data type	Comment
01	Read Coil Status	0x00 → RELAY1 0x01 → RELAY2	Bit	Read relay status.
02	Read Input Status	0x00 → INPUT1 0x01 → INPUT2	Bit	Read input status. A “TRUE” logic level on the inputs are extended to minimum 5 seconds.
03	Read Holding Registers	0x00 → HFT Version	Unsigned Integer	Value = 310 → V3.10
		0x01 → Pressure [mBar]	Signed Integer	Value = 0 ... 10,000 → 0 ... 10 Bar
		0x02 → Temperature [1/10 °C]	Signed Integer	Value = -350 ... 1,250 → -35.0 ... 125.0 °C
		0x08 → Error	Unsigned Integer	TRUE → Sensor error FALSE → Sensor OK
		0x09 → Device ID [HFT]	Unsigned Integer	Value = 40 → Device ID = 40
		0x0A → Pressure [Bar]	Float_ABCD	IEEE 32-bit floating-point
		0x0C → Filling Level [cm]	Float_ABCD	IEEE 32-bit floating-point
		0x0E → Volume [l]	Float_ABCD	IEEE 32-bit floating-point
	0x14 → Temperature [°C]	Float_ABCD	IEEE 32-bit floating-point	
04	Read Input Registers	-	-	-
05	Force Single Coil	0x00 → RELAY1 0x01 → RELAY2	Bit	Write relay status, if it is released to Modbus control (→ 7.4 Output menu, Page 14). value = 0x0000 → Relay off value = 0xFF00 → Relay on

Tab. 19 Modbus functions

1) The designation of the relay (coils), inputs and register starts with “1” (physical address “0”).

10.8 Modbus RTU message formats

Formats	Data																						
Coding System	8 bit binary																						
Number of data bits per character	<div style="border: 1px solid black; padding: 10px; margin-bottom: 10px;"> <p style="text-align: center;">With Parity Checking</p> <table border="1" style="width: 100%; text-align: center; border-collapse: collapse;"> <tr> <td style="width: 10%;">Start</td> <td style="width: 10%;">1</td> <td style="width: 10%;">2</td> <td style="width: 10%;">3</td> <td style="width: 10%;">4</td> <td style="width: 10%;">5</td> <td style="width: 10%;">6</td> <td style="width: 10%;">7</td> <td style="width: 10%;">8</td> <td style="width: 10%;">Par</td> <td style="width: 10%;">Stop</td> </tr> </table> </div> <div style="border: 1px solid black; padding: 10px;"> <p style="text-align: center;">Without Parity Checking</p> <table border="1" style="width: 100%; text-align: center; border-collapse: collapse;"> <tr> <td style="width: 10%;">Start</td> <td style="width: 10%;">1</td> <td style="width: 10%;">2</td> <td style="width: 10%;">3</td> <td style="width: 10%;">4</td> <td style="width: 10%;">5</td> <td style="width: 10%;">6</td> <td style="width: 10%;">7</td> <td style="width: 10%;">8</td> <td style="width: 10%;">Stop</td> <td style="width: 10%;">Stop</td> </tr> </table> </div>	Start	1	2	3	4	5	6	7	8	Par	Stop	Start	1	2	3	4	5	6	7	8	Stop	Stop
Start	1	2	3	4	5	6	7	8	Par	Stop													
Start	1	2	3	4	5	6	7	8	Stop	Stop													
Parity	Even or No																						
Bit transfer rate	2400, 4800, 9600, 19200, 38400 Selectable																						
Duplex	Half duplex Transceiver with Failsafe																						
Error checking	CRC (cyclic redundancy check)																						
Polynomial	(CRC-16 10100000000001)																						
Bit transfer order	LSB first																						
End of message	Idle line for 3.5 or more characters (>1.75 msec for >19200 Bps)																						

Tab. 20 Modbus RTU Message Formats

Pre-set values

- Address: 41
- Transfer rate: 9600 bps
- Interface:
 - 8 data bits
 - Same parity
 - 1 stop bit

