

Temperature and pressure monitoring sensor

Original operating manual

Series
PTM R
PTM R Flex

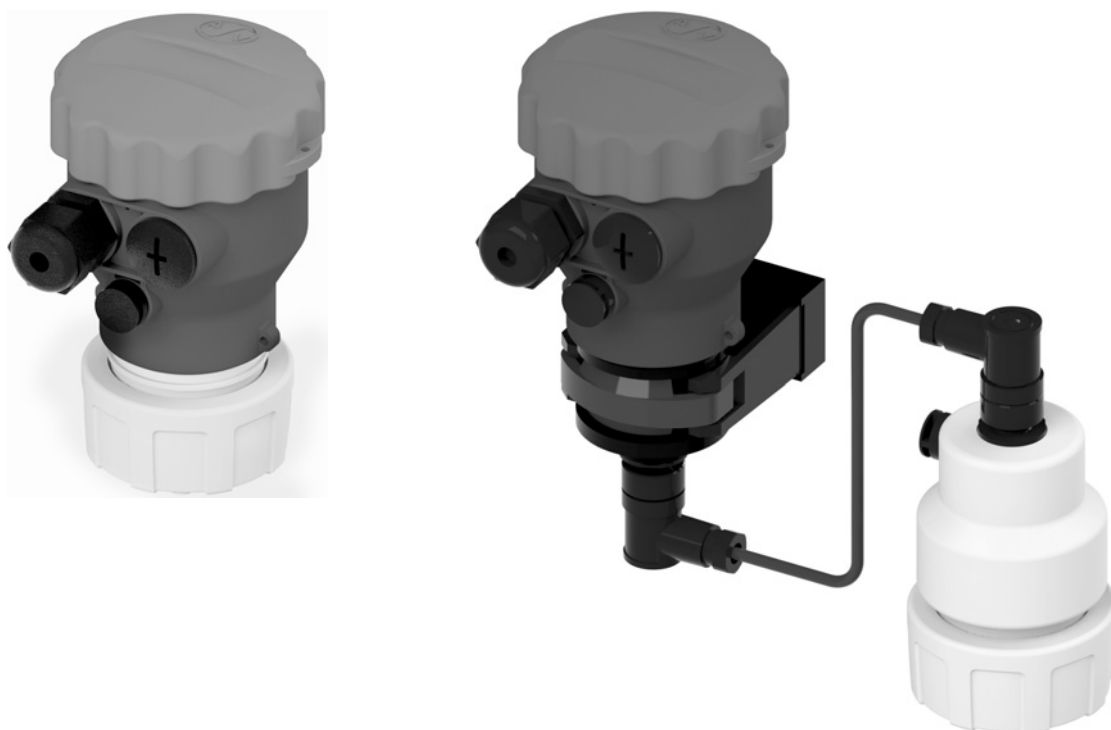

Version BA-2016.11.30 EN
Print-No. 300 004
TR MA DE Rev003

ASV Stübbe GmbH & Co. KG
Hollwieser Strasse 5
32602 Vlotho
Germany
Phone: +49 (0)5733-799-0
Fax: +49 (0)5733-799-5000
Email: contact@asv-stuebbe.de
Internet: www.asv-stuebbe.com



We reserve the right to make technical changes.

Read carefully before use.
Save for future use.

Table of contents

1	About this document	4	7.4.2	Setting switch type	13
1.1	Target groups	4	7.4.3	Setting the switch behavior for pump monitoring	13
1.2	Other applicable documents	4	7.4.4	Setting the switch behavior for the pressure or temperature switch type	14
1.3	Warnings and symbols	4	7.5	Display menu	14
2	General safety instructions	5	7.6	Diagnostics menu	15
2.1	Intended use	5	7.7	Service menu	15
2.2	General safety instructions	5	8	Maintenance	16
2.2.1	Obligations of the operating company	5	8.1	Servicing	16
2.2.2	Obligations of personnel	5	8.2	Maintenance	16
2.3	Specific hazards	5	8.2.1	Removing the device	16
2.3.1	Hazardous media	5	8.2.2	Replacement parts and return	16
3	Layout and Function	6	9	Troubleshooting	17
3.1	Type plate	6	9.1	Troubleshooting	17
3.2	Description	6	9.1.1	Fixingsoftware loading errors	17
3.3	Layout	7	10	Appendix	18
3.3.1	Housing and sensor	7	10.1	Technical specifications	18
3.3.2	UNI display	7	10.2	Dimensions	18
3.3.3	Measured value display	7	10.3	Accessories	18
4	Transport, Storage and Disposal	8	10.4	Application examples	18
4.1	Unpacking and inspection on delivery	8	10.4.1	Pump monitoring	18
4.2	Transportation	8	10.4.2	Excess / negative pressure monitoring	20
4.3	Storage	8	10.5	Relay connection plan	22
4.4	Disposal	8	10.6	Pin assignment on sensor cable	22
5	Installation and connection	9			
5.1	Check operating conditions	9			
5.2	Installing device in the process pipework	9			
5.3	Performing the hydrostatic test	9			
5.4	Electrical connection of device	9			
6	Operation	10			
6.1	Basic operation using the UNI display	10			
6.1.1	Measured value display	10			
6.1.2	Parameterizing	10			
6.2	Initial start-up with UNI display	11			
6.3	Managing several devices	11			
6.3.1	Backing up parameter sets	11			
6.3.2	Parameterizing several devices	11			
6.4	Reading the data logger	11			
6.5	Updating firmware	11			
7	Menus and functions	12			
7.1	Measured value display	12			
7.2	Main menu	12			
7.3	Basic settings menu	12			
7.4	Output menu	13			
7.4.1	Selecting relay output	13			

List of figures

Fig. 1	Type plate	6
Fig. 2	Housing and sensor layout	7
Fig. 3	UNI display layout	7
Fig. 4	Display of measured values	7
Fig. 5	UNI display	10
Fig. 6	Pump monitoring connection diagram	19
Fig. 7	Excess / negative pressure connection diagram	21
Fig. 8	Connection diagram	22
Fig. 9	Pin assignment for the Flex version	22

List of tables

Tab. 1	Other application documents, purpose and where found	4
Tab. 2	Warnings and symbols	4
Tab. 3	Button functions with measured value display	10
Tab. 4	Button functions when parameterizing	10
Tab. 5	Button function with measured value display	12
Tab. 6	Main menu	12
Tab. 7	Basic settings menu	12
Tab. 8	Output menu	13
Tab. 9	Output menu, switch type	13
Tab. 10	Output menu, pump monitoring	13
Tab. 11	Output menu, pressure / temperature monitoring	14
Tab. 12	Display menu	14
Tab. 13	Diagnostics menu	15
Tab. 14	Data logger settings	15
Tab. 15	Service menu	15
Tab. 16	Servicing activities	16
Tab. 17	Troubleshooting	17
Tab. 18	Accessories	18
Tab. 19	Pump monitoring setting	18
Tab. 20	Excess / negative pressure setting	20
Tab. 21	Terminal allocation	22

1 About this document

This manual

- is part of the equipment
- applies to all series referred to
- describes safe and proper operation during all operating phases

1.1 Target groups



Operating company

- Responsibilities:
 - Always keep this manual accessible where the device is used on the system.
 - Ensure that employees read and observe this document, particularly the safety instructions and warnings, and the documents which also apply.
 - Observe any additional country-specific rules and regulations that relate to the system.

Qualified personnel, fitter







- Mechanics qualification:
 - Qualified employees with additional training for fitting the respective pipework.
- Electrical qualification:
 - Qualified electrician
- Responsibility:
 - Read, observe and follow this manual and the other applicable documents, especially all safety instructions and warnings.

1.2 Other applicable documents

To download: Resistance lists Resistance of materials used to chemicals www.asv-stuebbe.de/pdf_resistance/300051.pdf	
To download: Data sheet Technical specifications, conditions of operation www.asv-stuebbe.de/pdf_datasheets/300250.pdf	
To download: CE declaration of conformity Conformity with standards www.asv-stuebbe.de/pdf_DOC/300056.pdf	

Tab. 1 Other application documents, purpose and where found

1.3 Warnings and symbols

Symbol	Meaning
	<ul style="list-style-type: none"> • Immediate acute risk • Death, serious bodily harm
	<ul style="list-style-type: none"> • Potentially acute risk • Death, serious bodily harm
	<ul style="list-style-type: none"> • Potentially hazardous situation • Minor injury
	<ul style="list-style-type: none"> • Potentially hazardous situation • Material damage
	Safety warning sign ► Take note of all information highlighted by the safety warning sign and follow the instructions to avoid injury or death.
►	Instruction
1. , 2. , ...	Multiple-step instructions
✓	Precondition
→	Cross reference
	Information, notes

Tab. 2 Warnings and symbols

2 General safety instructions

 The manufacturer accepts no liability for damages caused by disregarding any of the documentation.

2.1 Intended use

The device simultaneously monitors pressure and temperature in a liquid medium. The device switches off the consuming unit using adjustable limit values when the actual value exceeds or falls below the limit values.

- The device must only be used for monitoring pressure and temperature in liquid media.
- Only use the device with suitable media (→ resistance lists).
- Adhere to the operating limits (→ [10.1 Technical specifications, Page 18](#)).

2.2 General safety instructions

 Observe the following regulations before carrying out any work.

2.2.1 Obligations of the operating company

Safety-conscious operation

- Only operate the device if it is in perfect technical condition and only use it as intended, staying aware of safety and risks, and in adherence to the instructions in this manual.
- Ensure that the following safety aspects are observed and monitored:
 - Intended use
 - Statutory or other safety and accident-prevention regulations
 - Safety regulations governing the handling of hazardous substances
 - Applicable standards and guidelines in the country where the pump is operated
- Make personal protective equipment available.

Qualified personnel

- Make sure all personnel tasked with work on the device have read and understood this manual and all other applicable documents, especially the safety, maintenance and repair information, before they start any work.
- Organize responsibilities, areas of competence and the supervision of personnel.
- The following work should be carried out by specialist technicians only:
 - Installation, repair and maintenance work
 - Work on the electrical system
- Make sure that trainee personnel only work on the device under supervision of specialist technicians.

2.2.2 Obligations of personnel

Only complete work on the device if the following requirements are met:

- System is empty
- System has been flushed
- System is depressurized
- System has cooled down
- System is secured against being switched back on again
- Do not make any modifications to the device.

2.3 Specific hazards

2.3.1 Hazardous media

- When handling hazardous media, observe the safety regulations for the handling of hazardous substances.
- Use personal protective equipment for all work on the device.
- Collect leaking pumped liquid and residues in a safe manner and dispose of in accordance with environmental regulations.

3 Layout and Function

3.1 Type plate

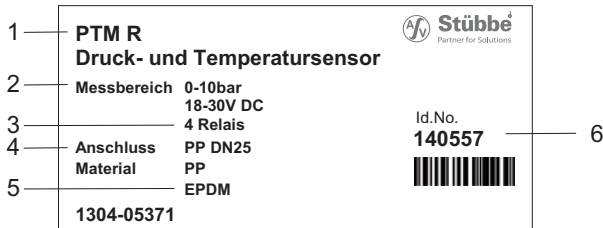

Fig. 1 Type plate

- 1 Device type
- 2 Pressure measurement range
- 3 Output
- 4 Connection (material and nominal diameter)
- 5 Gasket material
- 6 ID number

Device types

- PTM R – Standard, relay output
- PTM R Flex – Flex, relay output

3.2 Description

The device allows basic protection of a pump from running dry. The device monitors the pressure and temperature of a fluid medium for this purpose. It switches off a consuming unit (e.g. pump) if limit values are exceeded or not achieved. The limit values are adjustable.

The device is integrated within the control of the consuming unit using the following inputs and outputs:

- 4 relay outputs
- 2 switching inputs

Versions available:

- Standard
 - Compact housing
 - Process connection directly under the connection housing
- Flex
 - Connection and sensor housing separate
 - Process connection linked to the connection housing via a cable

The UNI display (optional) shows measured value. It can be used for all measuring instruments of the UNI display device platform PTM, HFT and UFM. The UNI display offers the following additional functions:

- Graphic filling level display
- Displays status of the relay outputs
- Menu-guided device setting
- Data logger function with date stamp
- Saving and transfer of parameter settings to other sensors
- Memory function on microSD card
- Firmware update

3.3 Layout

3.3.1 Housing and sensor

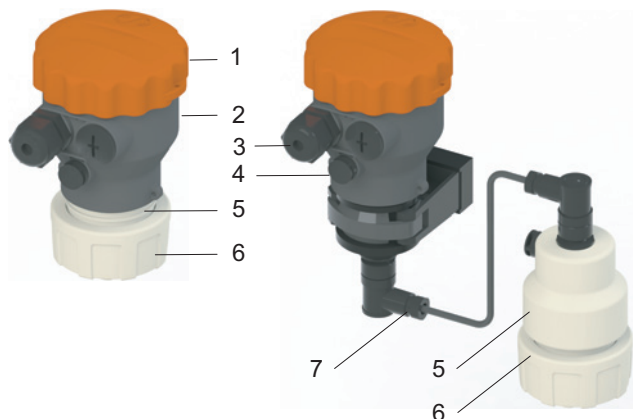

Fig. 2 Housing and sensor layout

- 1 Housing cover
- 2 Connection housing
- 3 Cable glands
- 4 Pressure compensation valve
- 5 Sensor housing
- 6 Process connection
- 7 Sensor cable

3.3.2 UNI display

The UNI display is fitted on to the connection housing (remove housing cover). The transparent cover supplied allows the measured values to be read during operation.

The device can be adjusted and put into operation using the UNI display.

The UNI display can be removed again once it has been put into operation. The UNI display remains attached if the intention is to display measured values permanently.

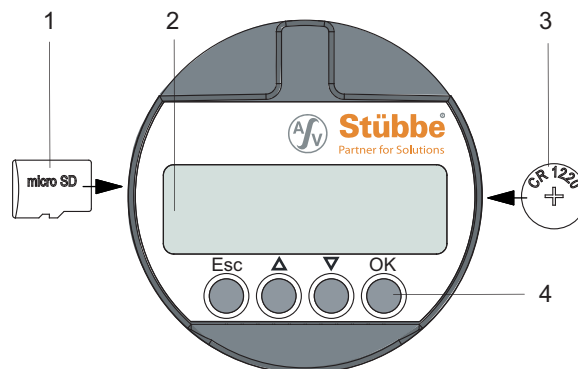

Fig. 3 UNI display layout

- 1 microSD card (with spring ejection)
- 2 Display
- 3 Battery
- 4 Operating buttons

3.3.3 Measured value display

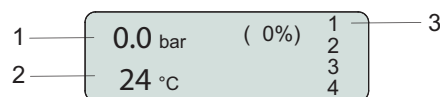

Fig. 4 Display of measured values

- 1 Pressure display (absolute and as a percentage)
- 2 Temperature display
- 3 Relay status display
Normal display = contact open
Inverted display = contact closed

4 Transport, Storage and Disposal

4.1 Unpacking and inspection on delivery

1. Unpack the device when received and inspect it for transport damage and completeness.
2. Check that the information on the type plate agrees with the order/design data.
3. Report any transport damage to the manufacturer immediately.
4. If fitted immediately: dispose of packaging material according to local regulations.
 - If fitted at a later point : leave device in its original packaging.

4.2 Transportation

- ▶ Device should preferably be transported in the original packaging.

4.3 Storage

NOTE

Material damage due to inappropriate storage!

- ▶ Store the device properly.
1. Make sure the storage room meets the following conditions:
 - Dry
 - Frost-free
 - Vibration-free
 - Not in direct sunlight
 - Storage temperature +10 °C to +60 °C
 2. Device should preferably be stored in the original packaging.

4.4 Disposal

-  Plastic parts can be contaminated by poisonous or radioactive media to such an extent that cleaning will not be sufficient.

WARNING

Risk of poisoning and environmental damage from medium.

- ▶ Use personal protective equipment when carrying out any work on the device.
 - ▶ Prior to the disposal of the device: Neutralize residues of medium in the device.
-

1. Remove battery and dispose of in accordance with local regulations.
2. Remove electronic parts and dispose of in accordance with local regulations.
3. Dispose of plastic parts in accordance with local regulations.

5 Installation and connection

5.1 Check operating conditions

1. Ensure the required operating conditions are met:
 - Resistance of body and seal material to the medium (→ resistance lists).
 - Media temperature (→ [10.1 Technical specifications, Page 18](#)).
 - Working pressure (→ [10.1 Technical specifications, Page 18](#)).
2. Consult with the manufacturer regarding any other use of the device.

5.2 Installing device in the process pipework

- ✓ Process pipework has been properly prepared.
- ✓ Process pipework has been secured against unintentional opening with shut-off valves.

 Avoidance of medium buildup.
 Select installation location so that no build-up or crystallization of the medium is possible.

 When used as pump protection, select installation location as follows:

- On the pressure side
- Close to the pump
- Before the first valve

WARNING

Risk of injury and poisoning due to medium spraying out.

- ▶ Use personal protective equipment when carrying out any work on the fitting.

1. Unscrew union nut.
2. Insert union nut on to the spool piece of the process pipework.
Check mounting direction.
3. Weld device insert to the process pipework spool piece.
4. Check O-ring fitting.
5. Connect device to the process pipework. Tighten union nut by hand only.

5.3 Performing the hydrostatic test

 Perform hydrostatic test using neutral medium, e.g. water.

1. Pressurize the device, ensuring
 - Test pressure < 1.5 x P_N (Nominal pressure)
 - Test pressure < P_N + 5 bar
 - Test pressure < permissible system pressure
2. Check that the device is not leaking.

5.4 Electrical connection of device

- ✓ Device is connected to the process pipework.
- ✓ Power supply is switched off and secured against being switched back on again.

 Cable without shielding can be used to connect the device. If electromagnetic interference is anticipated, then a shielded cable must be used.
 Terminal strips are pluggable.

DANGER

Risk of electrocution

- ▶ All electrical work must be carried out by qualified electricians only.
- ▶ Switch off system power supply and secure it against being switched back on again.

1. Unscrew the housing cover from the connection housing, remove UNI display if required.
2. Guide the connection cable through the cable glands and connect:
 - Cable (→ Data sheet).
 - Connection diagram (→ [10.5 Relay connection plan, Page 22](#)).
3. Tighten the cable glands securely.
4. Screw on the housing cover.
5. For the Flex version:
 - Cut sensor cable supplied to length.
 - Fit both plugs (→ [10.6 Pin assignment on sensor cable, Page 22](#)).
 - Connect connection housing and sensor housing using sensor cable.

6 Operation

NOTE

Changing parameters affects the switching outputs immediately.

- ▶ Make sure that changing a parameter does not trigger a malfunction (e.g. a pump running dry).

i When switching on the device, all relay contacts are open for 3 s (NO).
After this the relay contacts assume the status which corresponds with the setting and the measured values.

6.1 Basic operation using the UNI display

i Description of menus and functions
(→ 7.2 Main menu, Page 12).

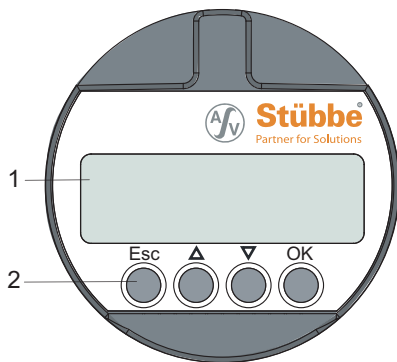

Fig. 5 UNI display

- 1 Display
- 2 Operating buttons

6.1.1 Measured value display

The display shows the measured value (e.g. volume).

Button	Function
OK	Main menu
Esc	Switches measured value display to time and date view.
▲ ▼ simultaneously	Changes the display direction.

Tab. 3 Button functions with measured value display

6.1.2 Parameterizing

Button	Functions
Esc	<ul style="list-style-type: none"> • Cancels input and switches to the higher-level menu. • Changes will not be saved.
▲	<ul style="list-style-type: none"> • Increases parameter value. • Previous menu/submenu • Press and hold to increase parameter value quickly. • Press ▼ at the same time to increase parameter value very quickly.
▼	<ul style="list-style-type: none"> • Reduces parameter value. • Previous menu/submenu. • Press and hold to reduce parameter value quickly. • Press ▲ at the same time to reduce parameter value very quickly.
OK	<ul style="list-style-type: none"> • Switches to the menu overview. • Switches to the menu/submenu selected. • Confirms parameter and saves value.
If no button is pressed	<ul style="list-style-type: none"> • The measured values are displayed after 2 minutes. • Changes will not be saved.

Tab. 4 Button functions when parameterizing

6.2 Initial start-up with UNI display

 The UNI display can be removed again once it has been put into operation.

The UNI display remains attached if the intention is to display measured values permanently.

If the display is upside down, press ▲ ▼ buttons simultaneously.

- ✓ Device is connected properly to the process pipework.
 - ✓ Device is connected properly with the power supply and ready for operation.
1. Unscrew the housing cover.
 2. Insert UNI display on to the electronic equipment (white plug-in location).
 3. Configure device (→ 7.2 Main menu, Page 12).
 4. Remove UNI display if necessary.
 5. Screw on housing cover or transparent cover.

6.3 Managing several devices

 Using the UNI display and microSD card, parameter sets can be transferred between devices or archived on a PC.

 All microSD cards or microSDHC cards with FAT32 formatting are supported. Files must be maintained in the master directory.

Files should be named in Format 8.3 (e.g. PARA_1.ASV), otherwise only an abbreviated file name is displayed.

The memory function always names the files STUEBBE.ASV. If a STUEBBE.ASV file already exists on the microSD card, then this file is overwritten.

6.3.1 Backing up parameter sets

1. Save the parameter set from the device on to the microSD card (→ 7.7 Service menu, Page 15).
2. Insert the microSD card into the PC, then transfer and archive the STUEBBE.ASV file.

6.3.2 Parameterizing several devices

1. Parameterize the first device (→ 7.2 Main menu, Page 12).
2. Save the parameter set from the device on to the microSD card (→ 7.7 Service menu, Page 15).
3. Attach the UNI display, with the microSD cards inserted, on to the next device.
4. Save the parameter set from the microSD card on to the device (→ 7.7 Service menu, Page 15).

6.4 Reading the data logger

 Series of measurements can be created and read using the UNI display and microSD card.

1. Insert microSD card into a UNI display and attach the UNI display to the device.
2. Set up the data logger function (→ 7.6 Diagnostics menu, Page 15).
3. Remove the microSD card and read the log file (csv format) on the PC.

6.5 Updating firmware

 Current sensor firmware or UNI display firmware can be obtained via the Internet (→ www.asv-stuebbe.com/service/downloads).



In the event that the updating is interrupted (→ 9.1.1 Fixingsoftware loading errors, Page 17).

1. Download the latest version of the sensor firmware (e. g. PTM_Vxxx.HEX) and UNI display firmware (UNI_Vxxx.HEX) from the Internet and save on the microSD card.
2. Insert the microSD card in a UNI display and attach the UNI display to the device.
3. Save sensor firmware or UNI display firmware from the microSD card on to the device (→ 7.7 Service menu, Page 15).
4. Observe release notes. If "reset factory settings" is necessary:
 - Note all parameters.
 - Perform "reset factory settings" (→ 7.2 Main menu, Page 12).
 - Reset the device (→ 7.7 Service menu, Page 15).
5. Check date and time, and reset if necessary (→ 7.3 Basic settings menu, Page 12).

7 Menus and functions

7.1 Measured value display

The display shows the measured value (e.g. volume).

Button	Function
OK	Main menu
Esc	Switches measured value display to time and date view.
▲ ▼ simultaneously	Changes the display direction.

Tab. 5 Button function with measured value display

7.2 Main menu

Main menu	Function
Basic settings	Performs basic settings (→ 7.3 Basic settings menu, Page 12).
Output	Adjusts the behavior of the outputs (→ 7.4 Output menu, Page 13).
Display	Sets the display options (→ 7.5 Display menu, Page 14).
Diagnostics	Checks the diagnostics functions (→ 7.6 Diagnostics menu, Page 15).
Service	Performs the service functions (→ 7.7 Service menu, Page 15).

Tab. 6 Main menu

7.3 Basic settings menu

Submenu values	Function
Language	
German English French Spanish Italian Русский	Sets the operating language
Lighting	
automatic	The display lighting switches on automatically for 15 seconds: <ul style="list-style-type: none"> • if the display value of the pressure changes by 5% • if there is a temperature change of more than 5 K
using any button	The display lighting switches on for 15 s each time a button is pressed.
off	Display lighting is always off.
on	Display lighting is always on.

Submenu values	Function
Integration time	
0 ... 60 s	Sets the measurement interval for the pressure sensor. An average is calculated and displayed using the measurement interval. This removes the effect of short-term pressure fluctuations. A long integration time delays the reaction to pressure fluctuations.
Calibration	
Basic calibration	The current pressure is set as the reference pressure (0 bar). All other measures then refer to this reference pressure.
min. calibration	Setting % display pressure. The value set is displayed as "0 %": <ul style="list-style-type: none"> ▶ ▲ ▼ – sets pressure value for 0 %. ▶ OK – accepts setting.
max. calibration	Setting % display pressure. The value set is displayed as "100 %": <ul style="list-style-type: none"> ▶ ▲ ▼ – sets pressure value for 100 %. ▶ OK – accepts setting.
Sensor type	
	Display of measurement range for the sensor installed. Do not change setting. Changing this setting results in incorrect measured values.
Output	
Current Relay	Display of interface type at output (current output, relay output). Do not change setting.
Time	
DD.MM.YYYY HH:MM	Display/setting of date and time. The first position in the date is underlined. <ul style="list-style-type: none"> ▶ ▲ ▼ – adjusts value. ▶ OK – accept value and set next position. ▶ After setting minutes, OK returns you to the basic settings menu.

Tab. 7 Basic settings menu

7.4 Output menu

7.4.1 Selecting relay output

 The relay output is set first, and then the switch type. The switch behavior can then be set depending on the switch type selected. All 4 relay outputs are set in the same way.

Submenu values	Function
Relay 1	▶ ▲▼ – select relay to be set.
Relay 2	The set values are displayed.
Relay 3	
Relay 4	

Tab. 8 Output menu

7.4.2 Setting switch type

Submenu values	Function
Switch type	Sets switch type
Pump monitoring	<ul style="list-style-type: none"> Dry running protection for pumps – Switches on/off when out of permissible pressure or temperature range (→ 7.4.3 Setting the switch behavior for pump monitoring, Page 13).
Pressure Temperature	<ul style="list-style-type: none"> Pressure – switches on/off with changes in pressure or temperature (→ 7.4.4 Setting the switch behavior for the pressure or temperature switch type, Page 14).

Tab. 9 Output menu, switch type

7.4.3 Setting the switch behavior for pump monitoring

NOTE

Material damage due to dry running of the pump

▶ Set the pump start-up time to be as short as possible. During this time the pump is not monitored.

 In the pump monitoring switch type, the device protects a pump from dry running and from the resulting damage. The pump can be switched on and off using inputs IN 1/2 (→ 10.4.1 Pump monitoring, Page 18).

Submenu values	Function
permissible pressure	
MIN ... MAX 0 ... 10 bar	Sets the permissible range for pump pressure: <ul style="list-style-type: none"> ▶ ▲▼ – sets MIN value. ▶ OK – accepts value. ▶ ▲▼ – sets MAX value.
permissible temperature	
MIN ... MAX -10 ... 100 °C	Sets the permissible range for medium pressure: <ul style="list-style-type: none"> ▶ ▲▼ – sets MIN value. ▶ OK – accepts value. ▶ Sets MAX value.
Pump start-up time	
1 ... 30 s	Sets pump start-up time. The pump must achieve the minimum pressure within the pump start-up time.

Tab. 10 Output menu, pump monitoring

7.4.4 Setting the switch behavior for the pressure or temperature switch type

Submenu values	Function
Switching point 1	
0 ... 10 bar 0 ... 125 °C	Sets switching point 1 (pressure or temperature). In window mode, the value for switching point 1 must always be above the value for switching point 2.
Switch delay 1	
0 ... 60 s	Sets the switch delay for switching point 1. The switch delay is the period after which the relay switches once a switching point has been reached. The switch delay prevents, for example, the relay from rattling in hysteresis mode.
Switching point 2	
	As for switching point 1
Switch delay 2	
	As for switch delay 1
Opener/Closer	
NO NC	Sets switch function: <ul style="list-style-type: none"> • NO – closer • NC – opener <p>The relay outputs do not assume the switch function set here until approximately 3 seconds after switching on.</p>
Mode	
Hysteresis Window	Sets mode: <ul style="list-style-type: none"> • Hysteresis <ul style="list-style-type: none"> – Switches on when value increases (pressure/temperature) at switch 1 – Switches off when value falls (pressure/temperature) at switch 2 • Window <ul style="list-style-type: none"> – Switches on between switching point 1 and switching point 2 – Switches off under switching point 1 or over switching point 2

Submenu values	Function
Measurement On	
0 ... 30 s	Sets switch-on delay. Delay time from switching on device up to first assessment of the measured values (= switching of the relay outputs). <ul style="list-style-type: none"> • 0 – no switch-on delay
Measurement Off	
off, 0 ... 30 s	Switch-off delay Delay time from switching on device up to switching off the assessment of the measured value (= Freezes the relay outputs). <ul style="list-style-type: none"> • off – no switch-off delay

Tab. 11 Output menu, pressure / temperature monitoring

7.5 Display menu

Submenu values	Function
Pressure	
mbar bar PSI	Sets unit of pressure
Temperature	
°C °F	Sets unit of temperature.

Tab. 12 Display menu

7.6 Diagnostics menu

 The data logger functions requires a microSD card. The data logger function saves the data in CSV format on the microSD card.

After the adjustable recording duration (per file) has expired, a new file is written until the microSD card is full or the data logger function is deactivated.

Submenu values	Function
Slave pointer	
Pressure	Displays minimum and maximum measured values for pressure
Temperature	Displays minimum and maximum measured values for temperature
	Reset slave point via Service – Reset – Slave pointer
Status	
Sensor OK	No error message, device functions normally.
Exxx	Error message (→ Table 17 Troubleshooting, Page 17).
Data logger	
off	Data logger function switched off.
Hour, day, month, year	Sets the recording duration for the data logger function. Measurement interval and file name correspond to the following table.

Tab. 13 Diagnostics menu

Recording duration (per file)	Measurement interval	File name
Hour	5 s	monthdayhour.csv e.g. 061814.csv
Day	2 min	yearmonthday e. g. 20140618.csv
Month	1 h	yearmonth.csv e.g. 201406.csv
Year	1.8 h	year.csv e.g 2014.csv

Tab. 14 Data logger settings

7.7 Service menu

 The UNI display supports all microSD or microSDHC cards with FAT32 formatting. Relevant file must be maintained in the master directory.

If transmission errors occur when loading a parameter set, then the UNI display will restore its factory settings.

The UNI display only displays files in 8.3 format.

Submenu values	Function
Reset	
Factory settings	Resets all parameters to the delivery state: ▶ OK – Delivery state is set.
Slave pointer	Resets slave pointer for pressure and temperature.
Info	
	Displays version of sensor firmware and UNI display firmware.
Memory	
to intermediate memory	Saves all parameters from the device on to the intermediate memory.
from intermediate memory	Saves all parameters from the intermediate memory on to the device.
to microSD card	Saves all parameters from the device on to the microSD card.
from the microSD card	Saves all parameters from the microSD card on to the device.
Update firmware	
firmware update for device	Load sensor firmware from the microSD card: ▶ Press and hold OK until "Bootloader" is displayed. ▶ Press OK - to list the existing files on the microSD card. ▶ ▲▼ – Selects file (e. g. PTM_Vxxx.HEX). ▶ OK – the new firmware is loaded on to the device and started immediately.
UniDisplay	Load UNI display firmware from the microSD card: ▶ Press and hold OK + Esc until "UNIBOOT" is displayed. ▶ Press OK - to list the existing files on the microSD card. ▶ ▲▼ – Selects file (UNI_Vxxx.HEX). ▶ OK – the new firmware is loaded into the device and immediately started.

Tab. 15 Service menu

8 Maintenance

⚠ DANGER

Risk of electrocution!

- ▶ All electrical work must be carried out by qualified electricians only.

⚠ WARNING

Risk of injury and poisoning due to hazardous or hot media.

- ▶ Use personal protective equipment for all work on the device.
- ▶ Allow device to cool.
- ▶ Make sure the device is depressurized.
- ▶ Block the media supply to the device.
- ▶ Empty the pipe and safely collect the media. Dispose of it in accordance with environmental regulations.
- ▶ Switch off the power supply to the system.
- ▶ Secure power supply against being switched back on again.
- ▶ Provide warning of maintenance and repair work and set up warning signs.

8.1 Servicing

Interval	Action
As necessary	<ul style="list-style-type: none"> • Clean device with a damp cloth.
Six-monthly	Visual and function check: <ul style="list-style-type: none"> • Normal operating conditions unchanged • No leaks • No unusual operating noises or vibrations
Yearly	<ul style="list-style-type: none"> • Replace UNI display battery.

Tab. 16 Servicing activities

- ▶ Perform maintenance tasks according to the table.

8.2 Maintenance

8.2.1 Removing the device

- ✓ System is empty.
 - ✓ System has been flushed.
 - ✓ System is depressurized.
 - ✓ System has cooled down.
 - ✓ System is secured against being switched back on again.
1. Unscrew the housing cover from the connection housing, remove UNI display if required,
 2. Disconnect connection cable.
 3. Screw on the housing cover.
 4. Disassemble device from the process pipework.
 5. Decontaminate device if required.

8.2.2 Replacement parts and return

1. Have the following information ready to hand when ordering spare parts (→ 3.1 Type plate, Page 6).
 - Device type
 - ID number
 - Nominal pressure and diameter
 - Connection and gasket material
2. Please complete and enclose the document of compliance for returns (→ www.asv-stuebbe.com/service/downloads).



3. Only use spare parts from ASV Stübbe.

9 Troubleshooting

WARNING

Risk of injury and poisoning due to hazardous media liquids!

- ▶ Use personal protective equipment when carrying out any work on the device.

Error	Possible cause	Corrective action
Medium is leaking out of the flange	Pre-tension of the O-ring too small	▶ Retighten union nut by hand.
"Display Vx.yy UNI" displayed	Error occurred when updating firmware	▶ Reload firmware (→ 9.1.1 Fixingsoftware loading errors, Page 17).
"E002 – no sensor" displayed	Cable connection to the sensor defective (only with Flex version)	▶ Check sensor cable (→ 10.6 Pin assignment on sensor cable, Page 22). ▶ Replace sensor cable.
	Sensor defective	▶ Replace device (for Standard version). ▶ Replace sensor housing (for Flex version)
Display remains dark	Faulty power supply	▶ Ensure power supply is present.
	Wrong version of UNI display firmware	▶ Reload firmware (→ 9.1.1 Fixingsoftware loading errors, Page 17).
Display is upside down	Wrong display direction	▶ Press ▲▼ buttons simultaneously to change display direction.

Tab. 17 Troubleshooting

9.1 Troubleshooting

9.1.1 Fixingsoftware loading errors

 If an error occurs when updating the sensor firmware or the UNI display firmware (e.g. power failure), it may not be possible to call up the "Update firmware" menu.

 The latest sensor firmware or UNI display firmware is available on the Internet
 (→ www.asv-stuebbe.com/service/downloads).



1. Save latest sensor firmware (e. g. PTM_Vxxx.HEX) or UNI display firmware (UNI_Vxxx.HEX) on to a microSD card.
2. Disconnect device from the power supply.
3. Insert UNI display and microSD card with current firmware where necessary.
4. Press hold OK in order to load the sensor firmware.
5. Press hold OK and ESC in order to load the UNI display firmware.
6. Switch on power supply.
7. OK, ▲▼ – Selects file.
8. Press OK.
The latest firmware is loaded.
9. Press "OK" again.
The latest firmware is launched.
10. Set the device again (→ 7.2 Main menu, Page 12).

10 Appendix

10.1 Technical specifications

 Technical data (→ Data sheet).

10.2 Dimensions

 Dimensions (→ Data sheet).

10.3 Accessories

Description	Ident. number
UNI display <ul style="list-style-type: none"> • Display and control unit • with PA transparent cover for the connector head • Languages: DE, EN, FR, ES, IT 	144153
Battery, CR1220, 3 V	144328
Memory card, Micro SD	144329

Tab. 18 Accessories

10.4 Application examples

10.4.1 Pump monitoring

 The application examples shows pump monitoring via relay output 1

Function

Inputs 1 and 2 can only be used with the pump monitoring switch type. The pump can be switched off using buttons s1 and s2.

After switching on the pump (releasing s1) the minimum pressure must be reached within the set pump-running time (8 s) otherwise the pump stops.

Relay 1 stops the pump:

- At media pressure < 2.5 bar or > 5.6 bar
- Media temperature < 10 °C or > 58 °C

Restarting is possible using the start button.

Setting (example)

Parameter	Relay 1
Switch type	Pump monitoring
permissible pressure	2.5 ... 5.6 bar (0 ... 10 bar)
permissible temperature	10 ... 58 °C (–9 ... 100 °C)
Pump-running time	8 s (1 ... 30 s)

Tab. 19 Pump monitoring setting

Connection diagram

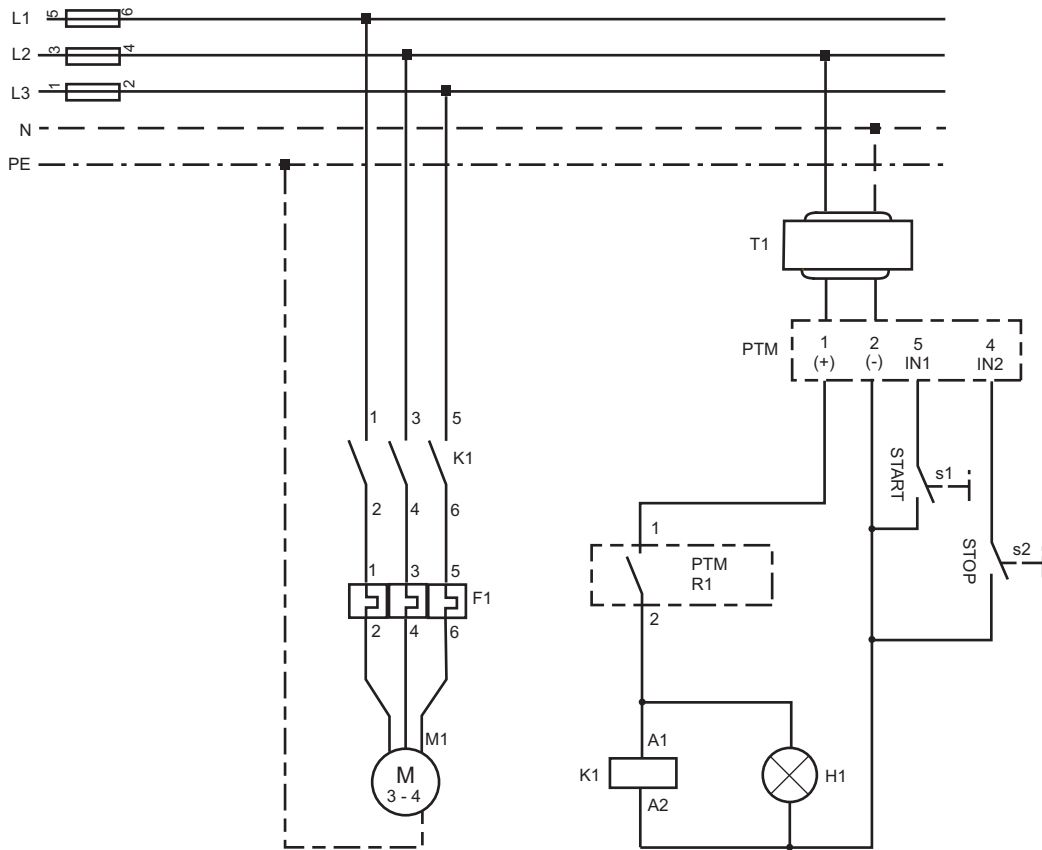



Fig. 6 Pump monitoring connection diagram

- F1 Motor protection relay
- H1 Pump indicator lamp
- K1 Motor protection
- M1 Pump motor
- s1 Start button
- s2 Stop button
- T1 Power supply 24 VDC

10.4.2 Excess / negative pressure monitoring

 The application examples shows excess / negative pressure monitoring via relay output 1

Function

The pump can be switched on using the s5 button and switched off using s4. Relay 2 provides a switch-on time delay (Measurement Off = delay period).

Relay 3 closes if the minimum pressure is reached, and switches the pump off if minimum pressure is not achieved (switching point 1 = switching point 2 = minimum pressure).

Relay 1 switches the pump off if the maximum pressure is not achieved (switching point 1) and on again, if the pressure falls below the minimum pressure (switching point 2). The pump remains off (no automatic restart) as relay 3 has switched off in the intervening period due the minimum pressure not being achieved.

The pump is automatically stopped:

- where media pressure < minimum pressure
- where media pressure < maximum pressure

The media temperature is not monitored. Restarting is possible using the start button.

Setting (example)

Parameter	Relay 1	Relay 2	Relay 3
Switch type	Pressure	Temperature	Pressure
Switching point 1	P_{max}	0 °C	P_{min}
Switch delay 1	0 s	0 s	0 s
Switching point 2	> 0 < P_{min}	0 °C	P_{min}
Switch delay 2	2 s	0 s	0 s
Mode	Hysteresis	Hysteresis	Hysteresis
Measurement On	0 s	0 s	0 s
Measurement Off	off	5 s	off

Tab. 20 Excess / negative pressure setting

Connection diagram

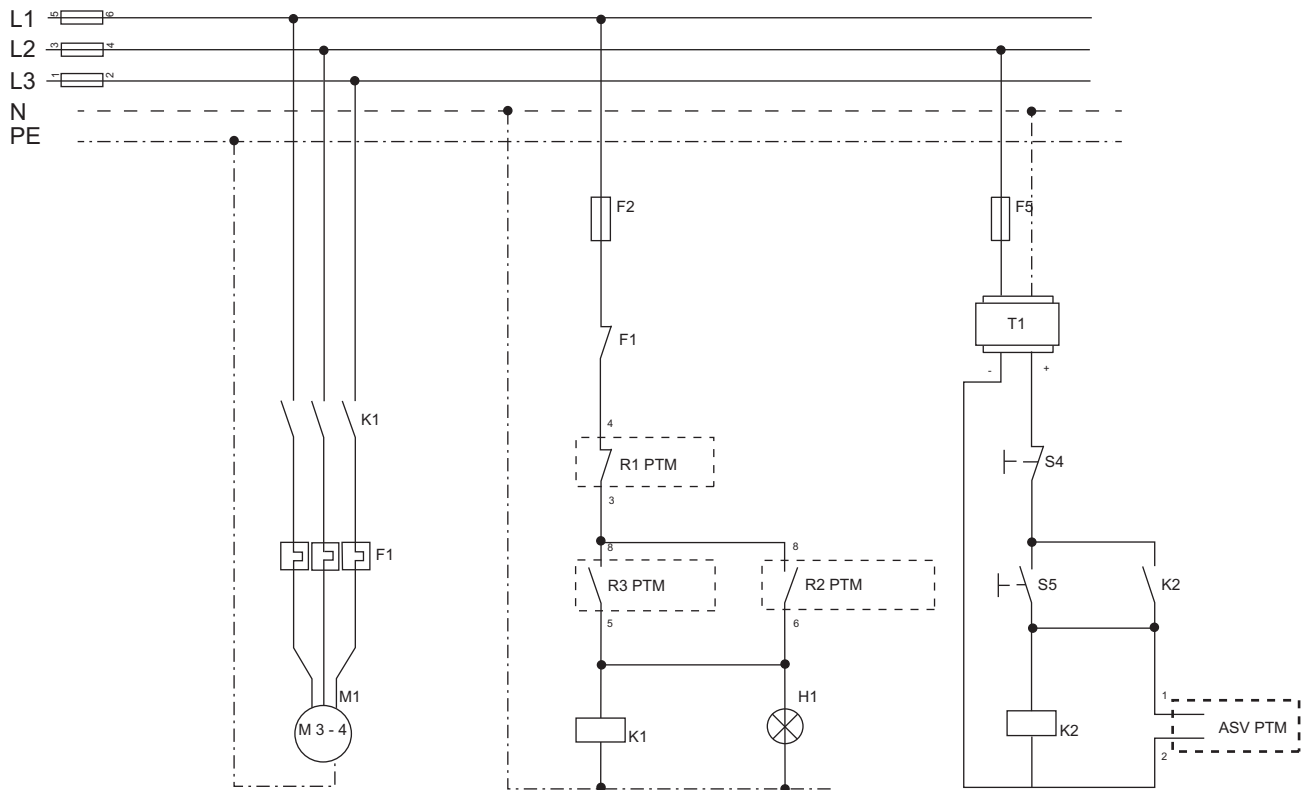

Fig. 7 Excess / negative pressure connection diagram

- F1 Motor protection relay
- H1 Pump indicator lamp
- K1 Motor protection
- M1 Pump motor
- s4 Stop button
- s5 Start button
- T1 Power supply 24 VDC

10.5 Relay connection plan

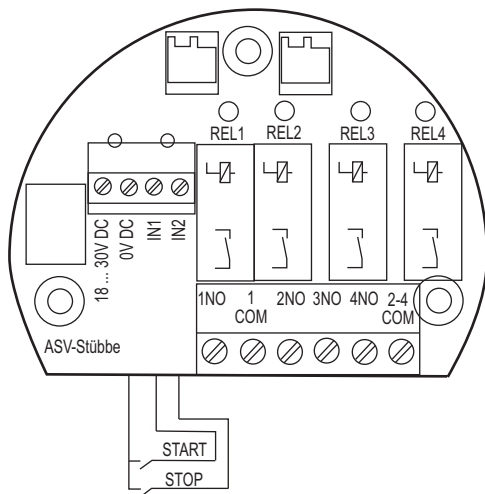

Fig. 8 Connection diagram

Terminal	Connection
18 ... 30 VDC	Power supply (18 ... 30 VDC)
0 VDC	Power supply (-)
IN1	Start button
IN2	Stop button
1NO	Relay 1 switch output
1COM	Relay 1 COM
2NO	Relay 2 switch output
3NO	Relay 3 switch output
4NO	Relay 4 switch output
2 - 4 COM	Relay 2 - 4 COM

Tab. 21 Terminal allocation

10.6 Pin assignment on sensor cable

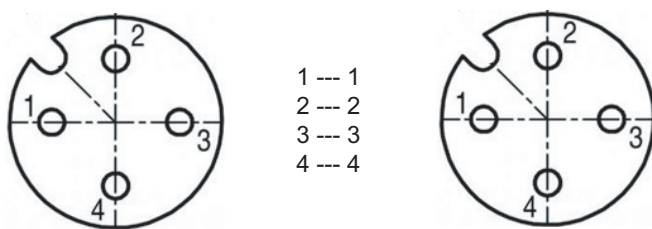

Fig. 9 Pin assignment for the Flex version