

CV 425 & 510

OPERATOR'S MANUAL



ENGLISH

LINCOLN[®]
ELECTRIC

THE WELDING EXPERTS[®]

Lincoln Electric Bester Sp. z o.o.
ul. Jana III Sobieskiego 19A, 58-263 Bielawa, Poland
www.lincolnelectric.eu

Declaration of conformity



Lincoln Electric Bester Sp. z o.o.

Declares that the welding machine:

K14080-2A CV 425 AIR 220/380/440V
K14081-2A CV 510 AIR 220/380/440V

conforms to the following directives:

2006/95/CEE, 2004/108/CEE

and has been designed in compliance with the
following standards:

EN 60974-1, EN 60974-10:2007



09.12.2011

Paweł Lipiński
Operations Director

Lincoln Electric Bester Sp. z o.o., ul. Jana III Sobieskiego 19A, 58-263 Bielawa, Poland

12/05



THE WELDING EXPERTS®

12/05

THANKS! For having chosen the **QUALITY** of the Lincoln Electric products.

- Please Examine Package and Equipment for Damage. Claims for material damaged in shipment must be notified immediately to the dealer.
- For future reference record in the table below your equipment identification information. Model Name, Code & Serial Number can be found on the machine rating plate.

Model Name:
Code & Serial Number:
Date & Where Purchased











ENGLISH INDEX



Safety	1
Installation and Operator Instructions	2
Electromagnetic Compatibility (EMC)	5
Technical Specifications	6
WEEE	7
Spare Parts	7
Electrical Schematic	7
Accessories	7



WARNING

This equipment must be used by qualified personnel. Be sure that all installation, operation, maintenance and repair procedures are performed only by qualified person. Read and understand this manual before operating this equipment. Failure to follow the instructions in this manual could cause serious personal injury, loss of life, or damage to this equipment. Read and understand the following explanations of the warning symbols. Lincoln Electric is not responsible for damages caused by improper installation, improper care or abnormal operation.

	<p>WARNING: This symbol indicates that instructions must be followed to avoid serious personal injury, loss of life, or damage to this equipment. Protect yourself and others from possible serious injury or death.</p>
	<p>READ AND UNDERSTAND INSTRUCTIONS: Read and understand this manual before operating this equipment. Arc welding can be hazardous. Failure to follow the instructions in this manual could cause serious personal injury, loss of life, or damage to this equipment.</p>
	<p>ELECTRIC SHOCK CAN KILL: Welding equipment generates high voltages. Do not touch the electrode, work clamp, or connected work pieces when this equipment is on. Insulate yourself from the electrode, work clamp and connected work pieces.</p>
	<p>ELECTRICALLY POWERED EQUIPMENT: Turn off input power using the disconnect switch at the fuse box before working on this equipment. Ground this equipment in accordance with local electrical regulations.</p>
	<p>ELECTRICALLY POWERED EQUIPMENT: Regularly inspect the input, electrode, and work clamp cables. If any insulation damage exists replace the cable immediately. Do not place the electrode holder directly on the welding table or any other surface in contact with the work clamp to avoid the risk of accidental arc ignition.</p>
	<p>ELECTRIC AND MAGNETIC FIELDS MAY BE DANGEROUS: Electric current flowing through any conductor creates electric and magnetic fields (EMF). EMF fields may interfere with some pacemakers and welders having a pacemaker shall consult their physician before operating this equipment.</p>
	<p>CE COMPLIANCE: This equipment complies with the European Community Directives.</p>
 <p><small>Optical radiation warning Category 2 (EN 12195)</small></p>	<p>ARTIFICIAL OPTICAL RADIATION: According with the requirements in 2006/25/EC Directive and EN 12198 Standard, the equipment is a category 2. It makes mandatory the adoption of Personal Protective Equipment (PPE) having filter with a protection degree up to a maximum of 15, as required by EN169 Standard.</p>
	<p>FUMES AND GASES CAN BE DANGEROUS: Welding may produce fumes and gases hazardous to health. Avoid breathing these fumes and gases. To avoid these dangers the operator must use enough ventilation or exhaust to keep fumes and gases away from the breathing zone.</p>
	<p>ARC RAYS CAN BURN: Use a shield with the proper filter and cover plates to protect your eyes from sparks and the rays of the arc when welding or observing. Use suitable clothing made from durable flame-resistant material to protect you skin and that of your helpers. Protect other nearby personnel with suitable, non-flammable screening and warn them not to watch the arc nor expose themselves to the arc.</p>
	<p>WELDING SPARKS CAN CAUSE FIRE OR EXPLOSION: Remove fire hazards from the welding area and have a fire extinguisher readily available. Welding sparks and hot materials from the welding process can easily go through small cracks and openings to adjacent areas. Do not weld on any tanks, drums, containers, or material until the proper steps have been taken to insure that no flammable or toxic vapors will be present. Never operate this equipment when flammable gases, vapors or liquid combustibles are present.</p>

	WELDED MATERIALS CAN BURN: Welding generates a large amount of heat. Hot surfaces and materials in work area can cause serious burns. Use gloves and pliers when touching or moving materials in the work area.
	CYLINDER MAY EXPLODE IF DAMAGED: Use only compressed gas cylinders containing the correct shielding gas for the process used and properly operating regulators designed for the gas and pressure used. Always keep cylinders in an upright position securely chained to a fixed support. Do not move or transport gas cylinders with the protection cap removed. Do not allow the electrode, electrode holder, work clamp or any other electrically live part to touch a gas cylinder. Gas cylinders must be located away from areas where they may be subjected to physical damage or the welding process including sparks and heat sources.
	SAFETY MARK: This equipment is suitable for supplying power for welding operations carried out in an environment with increased hazard of electric shock.

The manufacturer reserves the right to make changes and/or improvements in design without upgrade at the same time the operator's manual.

Installation and Operator Instructions

Read this entire section before installation or operation of the machine.

Location and Environment

This machine will operate in harsh environments. However, it is important that simple preventative measures are followed to assure long life and reliable operation:

- Do not place or operate this machine on a surface with an incline greater than 15° from horizontal.
- Do not use this machine for pipe thawing.
- This machine must be located where there is free circulation of clean air without restrictions for air movement to and from the air vents. Do not cover the machine with paper, cloth or rags when switched on.
- Dirt and dust that can be drawn into the machine should be kept to a minimum.
- This machine has a protection rating of IP23. Keep it dry when possible and do not place it on wet ground or in puddles.
- Locate the machine away from radio controlled machinery. Normal operation may adversely affect the operation of nearby radio controlled machinery, which may result in injury or equipment damage. Read the section on electromagnetic compatibility in this manual.
- Do not operate in areas with an ambient temperature greater than 40°C.

Duty cycle and Overheating

The duty cycle of a welding machine is the percentage of time in a 10 minute cycle at which the welder can operate the machine at rated welding current.

Example: 60% duty cycle

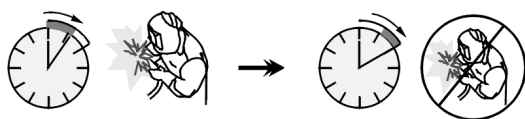

Welding for 6 minutes.

Break for 4 minutes.

Excessive extension of the duty cycle will cause the thermal protection circuit to activate.

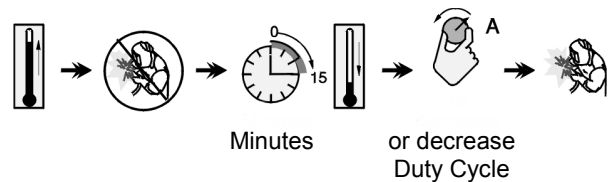

The machine is protected from overheating by a temperature sensor.

Input Supply Connection

WARNING

Only a qualified electrician can connect the welding machine to the supply network. Installation the outlet plug to power lead and connecting the welding machine had to be made in accordance with the appropriate National Electrical Code and local regulations.

Check the input voltage, phase, and frequency supplied to this machine before turning it on. Verify the connection of grounding wires from the machine to the input source. The allowable input voltages are 3x220V 50/60Hz, 3x380V 50/60Hz and 3x440V 50/60Hz (3x440V: factory default). For more information about input supply refer to the technical specification section of this manual and to the rating plate of the machine.

If it is necessary to change the input voltage:

- The input cable must be disconnected from the mains supply and the machine switched OFF.
- Remove the left side panel.
- Reconnect X6 according to the diagram below:

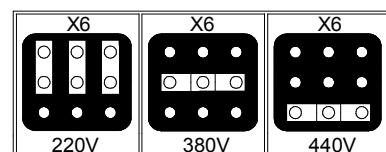

Figure 1.

- Replace the left side panel.

Make sure that the amount of mains power available from the input supply is adequate for normal operation of the machine. The necessary delayed fuse (or circuit breaker with "D" characteristic) and cable sizes are indicated in the technical specification section of this manual.

Output Connections

Refer to points [4], [5], [6] and [8] of the Figures 2.

Controls and Operational Features

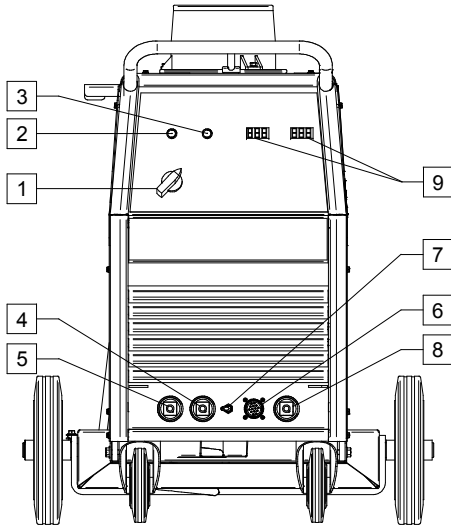

Figure 2.

1. **Power Switch ON/OFF (I/O):** Controls the input power to the machine. Be sure the power source is connected to the mains supply before turning power on ("I").



2. **Power Indicator Light:** After input power is connected and the power switch is turned on, this lamp will light up to indicate the machine is ready to weld.



3. **Thermal Overload Indicator:** This lamp will light up when the machine is overheated and the output has been turned off. This can occur if the ambient temperature is above 40°C or the duty cycle of the machine has been exceeded. Leave the machine on to allow the internal components to cool, when the lamp turns off normal operation is possible.



4. **Low Inductance Negative Output Socket:** For connecting a work lead.



5. **High Inductance Negative Output Socket:** For connecting a work lead.



6. **Wire Feeder Receptacle:** 14-pins receptacle for wire feeder. Provides connections for auxiliary power of wire feeder.



7. **Wire Feeder Voltmeter Switch:** This switch selects the polarity of the wire feeder voltmeter, if so equipped. When the welding torch is positive (MIG, Outershield and some Innershield processes), set the switch to "+". When

the welding torch is negative (most Innershield applications), set the switch to "-".



8. **Positive Output Socket:** Allows the connection, with the power cable, to the wire feeder.
9. **Digital Welding Current and Voltage Meter:** available as an option (see "Accessories" chapter – Kit K14082-1).

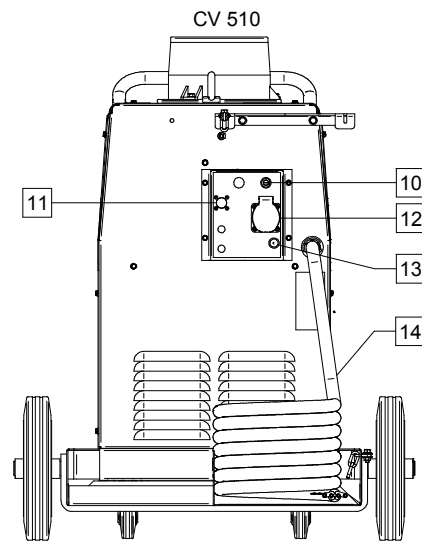
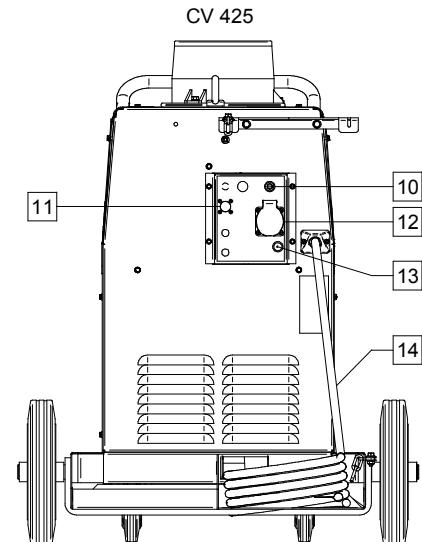

Figure 3.

10. **Fuse:** Use the 6,3A slow-blow fuse (see "Spare Parts" section).
11. **Hole Plug:** For CO₂ gas heater socket (see "Accessories" chapter - K14009-1 CO₂ Socket Kit).
12. **Cooler Power Supply Socket:** For supplying the cooler unit only.

WARNING

The socket has an output of 230V, 2.5A and is protected by the circuit breaker [13].



13. **Circuit Breaker:** Protects the Cooler Power Supply socket [12]. It shuts off the power supply when the current exceeds 2.5A. Press it to restore the power supply.

14. **Power Lead (5m):** Connect the supply plug to the existing input cable that is rated for the machine as indicated in this manual, and conforms to all applicable standards. This connection shall be performed only by a qualified person.

Welding Cables Connections

Insert the plug of the work cable into the socket [4] or [5]. The other end of this cable connects to the work piece with the work clamp.

Connect the wire feeder to the power source:

- insert the positive welding cable into the output socket [8].
- insert the wire feeder control cable into the socket [6] (see "Accessories" section, Source/wire feeder cable K10347-PG-xM or K10347-PGW-xM).

Use the shortest possible cable lengths

Machine and Circuit Protection

The CV425 / CV510 is protected against overheating, overload and accidental short-circuits

If the machine is overheated, the thermal protection circuit will decrease the output current to 0. The thermal protection indicator [3] will turn on. The thermal protection circuit will turn on the output current again, when the machine is cooled.

The CV425 / CV510 is also electronically protected against overload and accidental short-circuit. The overload and short-circuit protection circuit automatically reduces the output current to a safe value when it detects an overload.

Maintenance



WARNING

For any repair operations, modifications or maintenances, it is recommended to contact the nearest Technical Service Center or Lincoln Electric. Repairs and modifications performed by unauthorized service or personnel will cause, that the manufacturer's warranty will become null and void.

Any noticeable damage should be reported immediately and repaired.

Routine maintenance (everyday)

- Check condition of insulation and connections of the work leads and insulation of power lead. If any insulation damage exists replace the lead immediately.
- Remove the spatters from the welding gun nozzle. Spatters could interfere with the shielding gas flow to the arc.
- Check the welding gun condition: replace it, if necessary.
- Check condition and operation of the cooling fan. Keep clean its airflow slots.

Periodic maintenance (every 200 working hours but at list once every year)

Perform the routine maintenance and, in addition:

- Keep the machine clean. Using a dry (and low pressure) airflow, remove the dust from the external case and from the cabinet inside.
- If it is required, clean and tighten all weld terminals. The frequency of the maintenance operations may vary in accordance with the working environment where the machine is placed.



WARNING

Do not touch electrically live parts.



WARNING

Before the case of welding machine will be removed, the welding machine had to be turned off and the power lead had to be disconnected from mains socket.



WARNING

Mains supply network must be disconnected from the machine before each maintenance and service. After each repair, perform proper tests to ensure safety.

Transport

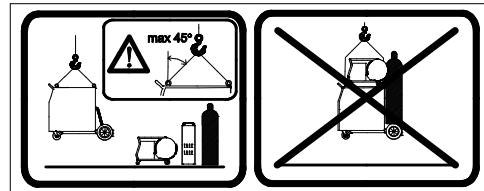

Figure 4.

To ensure safety transport it is to:

- Lift only power source without gas cylinder , cooler and wire feeder,
- Screw down an eye bolt and apply load axially in 45 degree angle in accordance to the drawing.
- Ensure equal length of lifting lines.

Electromagnetic Compatibility (EMC)

11/04

This machine has been designed in accordance with all relevant directives and standards. However, it may still generate electromagnetic disturbances that can affect other systems like telecommunications (telephone, radio, and television) or other safety systems. These disturbances can cause safety problems in the affected systems. Read and understand this section to eliminate or reduce the amount of electromagnetic disturbance generated by this machine..



This machine has been designed to operate in an industrial area. To operate in a domestic area it is necessary to observe particular precautions to eliminate possible electromagnetic disturbances. The operator must install and operate this equipment as described in this manual. If any electromagnetic disturbances are detected the operator must put in place corrective actions to eliminate these disturbances with, if necessary, assistance from Lincoln Electric.

Before installing the machine, the operator must check the work area for any devices that may malfunction because of electromagnetic disturbances. Consider the following.

- Input and output cables, control cables, and telephone cables that are in or adjacent to the work area and the machine.
- Radio and/or television transmitters and receivers. Computers or computer controlled equipment.
- Safety and control equipment for industrial processes. Equipment for calibration and measurement.
- Personal medical devices like pacemakers and hearing aids.
- Check the electromagnetic immunity for equipment operating in or near the work area. The operator must be sure that all equipment in the area is compatible. This may require additional protection measures.
- The dimensions of the work area to consider will depend on the construction of the area and other activities that are taking place.

Consider the following guidelines to reduce electromagnetic emissions from the machine.

- Connect the machine to the input supply according to this manual. If disturbances occur it may be necessary to take additional precautions such as filtering the input supply.
- The output cables should be kept as short as possible and should be positioned together. If possible connect the work piece to ground in order to reduce the electromagnetic emissions. The operator must check that connecting the work piece to ground does not cause problems or unsafe operating conditions for personnel and equipment.
- Shielding of cables in the work area can reduce electromagnetic emissions. This may be necessary for special applications.

WARNING

The Class A equipment is not intended for use in residential locations where the electrical power is provided by the public low-voltage supply system. There may be potential difficulties in ensuring electromagnetic compatibility in those locations, due to conducted as well as radiated disturbances.

WARNING

This equipment complies with IEC 61000-3-12 provided that the short-circuit power S_{sc} is greater than or equal to:

CV 425: $S_{sc} \geq 9,5$ MVA
CV 510: $S_{sc} \geq 14,3$ MVA

at the interface point between the user's supply and the public system. It is the responsibility of the installer or user of the equipment to ensure, by consultation with the distribution network operator if necessary, that the equipment is connected only to a supply with a short circuit power S_{sc} greater than or equal to data on the table above.

Technical Specifications

NAME		INDEX		
CV 425		K14080-2A		
CV 510		K14081-2A		
INPUT				
	Input Voltage U_1	EMC Group / Class	Frequency	
CV 425	220/380/400V±10% 3 - phases	II / A	50 / 60 Hz	
CV 510				
	Input Power at Rated Cycle	Input Amperes I_{1max}	$\cos \varphi$	
CV 425	23 kVA @ 60% Duty Cycle	60 A	0,89	
CV 510	29,2 kVA @ 60% Duty Cycle	75 A	0,89	
RATED OUTPUT				
	Duty Cycle 40°C (based on a 10 min. period)	Output Current	Output Voltage	
CV 425	60%	420 A	35 Vdc	
	100%	325 A	30,3 Vdc	
CV 510	60%	500 A	39 Vdc	
	100%	385 A	33,3 Vdc	
OUTPUT RANGE				
	Welding Current Range	Open Circuit Voltage		
CV 425	10 A ÷ 420 A	10 ÷ 39 Vdc		
CV 510	10 A ÷ 500 A	10 ÷ 39 Vdc		
RECOMMENDED INPUT CABLE AND FUSE SIZES				
	Fuse or Circuit Breaker Size			Power Lead
	220V	380V	440V	4 Conductor, 6 mm ²
CV 425	D63 A	D32 A	D32 A	
CV 510	D63 A	D32 A	D32 A	4 Conductor, 10 mm ²
DIMENSION				
	Weight	Height	Width	Length
CV 425	152 kg	880 mm	696 mm	1020 mm
CV 510	160 kg	880 mm	696 mm	1020 mm
	Protection Rating	Operating Humidity (t=20°C)	Operating Temperature	Storage Temperature
	IP23	≤ 90 %	from -10 °C to +40 °C	from -25 °C to +55 °C

WEEE

07/06

English

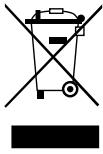

Do not dispose of electrical equipment together with normal waste!

In observance of European Directive 2002/96/EC on Waste Electrical and Electronic Equipment (WEEE) and its implementation in accordance with national law, electrical equipment that has reached the end of its life must be collected separately and returned to an environmentally compatible recycling facility. As the owner of the equipment, you should get information on approved collection systems from our local representative.

By applying this European Directive you will protect the environment and human health!

Spare Parts

12/05

Part list reading instructions

- Do not use this part list for a machine if its code number is not listed. Contact the Lincoln Electric Service Department for any code number not listed.
- Use the illustration of assembly page and the table below to determine where the part is located for your particular code machine.
- Use only the parts marked "●" in the column under the heading number called for in the assembly page (# indicate a change in this printing).

First, read the Part List reading instructions above then refer to the "Spare Part" manual supplied with the machine, which contains a picture-descriptive part number cross-reference).

Electrical Schematic

Refer to the "Spare Parts" manual supplied with the machine.

Accessories

K10347-PG-xxM	Source/wire feeder cable (gas). Available in 5, 10, 15m.
K10347-PGW-xxM	Source/wire feeder cable (gas and water). Available in 5, 10 or 15m.
K14009-1	CO ₂ Socket Kit.
K14082-1	AV Meter Kit.
K14071-2	Grill Kit.
K14037-1	Cooler COOLARC 25.