

BL983313 • BL983317 • BL983320 • BL983322 • BL983327

EC Process Mini Controller Series



BL983315 • BL983318 • BL983319 • BL983321 • BL983324 • BL983329

TDS Process Mini Controller Series



Dear Customer,

Thank you for choosing a Hanna Instruments® product.

Please read this instruction manual carefully before using this instrument as it provides the necessary information for correct use of this instrument as well as a precise idea of its versatility.

If you need additional technical information, do not hesitate to e-mail us at tech@hannainst.com. Visit www.hannainst.com for more information about Hanna Instruments and our products.

TABLE OF CONTENTS

1. Preliminary Examination	3
2. General Safety & Installation Recommendations.....	3
3. General Description & Intended Use	3
4. Controller Specifications	4
5. Probe Specifications.....	5
6. Functional Description.....	6
6.1. Front Panel	6
6.2. Rear Panel	6
7. Installation	7
7.1. Unit Mount	7
7.2. Rear Panel Connections	7
8. Operations.....	8
8.1. Calibration	8
8.2. Setpoint configuration.....	9
8.3. Monitoring.....	9
8.4. Probe Maintenance.....	9
9. Accessories.....	10
Certification.....	10
Recommendations for Users.....	10
Warranty	10

*All rights are reserved. Reproduction in whole or in part is prohibited without the written consent of the copyright owner, Hanna Instruments Inc., Woonsocket, Rhode Island, 02895, USA.
Hanna Instruments reserves the right to modify the design, construction, or appearance of its products without advance notice.*

1. PRELIMINARY EXAMINATION

Remove the instrument and accessories from the packaging and examine it carefully.

For further assistance, please contact your local Hanna Instruments office or email us at tech@hannainst.com.

Each instrument is supplied with:

- Mounting brackets
- Transparent cover
- 12 VDC power adapter (BL9833XX-0 only)
- Quick reference guide with instrument quality certificate

Note: Save all packing material until you are sure that the instrument works correctly. Any damaged or defective item must be returned in its original packing material with the supplied accessories.

2. GENERAL SAFETY & INSTALLATION RECOMMENDATIONS

Procedures and instructions detailed in this manual may require special precautions to ensure personnel safety.



- Electrical connection, installation, start-up, operation and maintenance must be carried out by specialized personnel only. The specialized personnel must have read and understood the instructions in this manual and should adhere to them.



- User serviceable connections are clearly labeled on the back panel.
- Before powering the controller, verify wiring has been done properly.
- Always disconnect the instrument from power when making electrical connections.
- A clearly marked disconnect switch must be installed in the vicinity of the instrument to ensure that the electrical circuit is completely de-energized for service or maintenance.

3. GENERAL DESCRIPTION & INTENDED USE

Hanna Instruments EC and TDS process conductivity mini controller series are compact panel mount units designed to conveniently measure the electrolytic conductivity of a process stream.

BL9833XX-Y series configuration

XX	13	15	17	18	19	20	21	22	24	27	29
Y	-0 (12 VDC)		-1 (115 or 230 VAC)			-2 (115 or 230 VAC, 4-20 mA output)					

Intended applications

Quality control of water produced from reverse osmosis, ion exchange, distillation processes, cooling towers; process control of source water, rinse water, drinking water, boiler water, and of other industrial, agriculture-specific applications

Main Features

- Option to select manual or automatic dosing mode
- Dry contact dosing relay, active when the reading is above/below a programmable setpoint (model dependent)
- Programmable overdosing timer, stops dosing if setpoint is not reached within a specified time interval
- 4-20 mA galvanic isolated output with external dosing disable contact (BL9833XX-2 only)
- Temperature compensated readings from 5 to 50 °C (41 to 122 °F)
- Internal fuse protected dosing contacts
- Large, clear LCD and LED operational indicator
- Splash-resistant transparent cover

4. CONTROLLER SPECIFICATIONS

	BL983313	BL983317	BL983320	BL983322	BL983327	BL983315	BL983318	BL983319	BL983321	BL983324	BL983329	
Type	EC						TDS					
	$\mu\text{S}/\text{cm}$	mS/cm	$\mu\text{S}/\text{cm}$	$\mu\text{S}/\text{cm}$	mS/cm	mg/L (ppm)	g/L (ppt)	mg/L (ppm)	mg/L (ppm)	mg/L (ppm)	mg/L (ppm)	
Range	0–1999	0.00–10.00	0.0–199.9	0.00–19.99	0.00–10.00	0.0–199.9	0.00–10.00	0–1999	0.00–19.99	0.0–49.9	0–999	
Resolution	1	0.01	0.1	0.01	0.01	0.1	0.01	1	0.01	0.1	1	
TDS Factor	–	–	–	–	–	0.5	0.5	0.65	0.5	0.5	0.5	
Accuracy	$\pm 2\%$ F.S. at 25 °C (77 °F)											
Temperature compensation	automatic, from 5 to 50 °C (41 to 122 °F), with $\beta = 2\%$ /°C											
Calibration	manual, with calibration trimmer											
Output	galvanic isolated 4-20 mA output; accuracy ± 0.2 mA; 500 Ω maximum load (BL9833XX-2 only)											
Adjustable setpoint	covers measure range											
Relay closes when measurement is	> setpoint	< setpoint	> setpoint	> setpoint	> setpoint	> setpoint	< setpoint	< setpoint	< setpoint	> setpoint	> setpoint	
	Dosing Contact											
Overtime	Dosing relay is disabled if setpoint is not reached within the set time interval. Timer adjustable between approx. 5 to 30 minutes, or disabled by jumper.											
External disable input	Normally Open: enable / Closed: disable dosing (BL9833XX-2 only)											
12 VDC adapter	BL983313-0	BL983317-0	BL983320-0	BL983322-0	BL983327-0	BL983315-0	BL983318-0	BL983319-0	BL983321-0	BL983324-0	BL983329-0	
115/230 VAC	BL983313-1	BL983317-1	BL983320-1	BL983322-1	BL983327-1	BL983315-1	BL983318-1	BL983319-1	BL983321-1	BL983324-1	BL983329-1	
115/230 VAC with 4-20 mA output	BL983313-2	BL983317-2	BL983320-2	BL983322-2	BL983327-2	BL983315-2	N/A	BL983319-2	N/A	N/A	BL983329-2	
Input	10 VA for 115/230 VAC, 50/60 Hz models; 3 W for 12 VDC models; fuse protected; installation category II.											
* H17632-00	•	•	•	•	•	•	•	•	•	•	•	
H17634-00	•	•	•	•	•	•	•	•	•	•	•	
Dimensions	83 x 53 x 92 mm (3.3 x 2.1 x 3.6")											
Weight	12 VDC models, 200 g (7.1 oz); 115/230 VAC models 300 g (10.6 oz)											

* Sold separately.

5. PROBE SPECIFICATIONS

HI7632-00 and HI7634-00 probes are sold separately.

		HI7632-00	HI7634-00
Type	Two-pole Amperometric		•
NTC sensor	4.7 K Ω	•	—
	9.4 K Ω	—	•
Cell constant	1 cm ⁻¹		•
Materials	PVC body; AISI 316 electrodes		•
Temperature	5 to 50 °C (41 to 122 °F)		•
Maximum pressure	3 bar		•
Probe length	64 mm (2.5")		•
Connection	½" NPT thread		•
Cable length	2 m (6.6')		•
	4 m (13.1')	—	•
	5 m (16.4')	—	•
	6 m (19.7')	•	

Probe Dimension

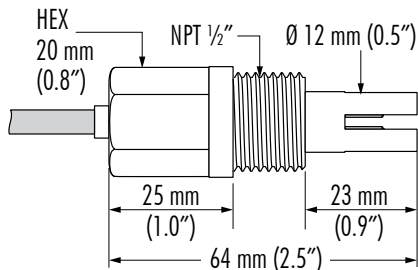

Probe Wiring

Easy access to the controller terminals enables quick wiring.

Probe low voltage connections are made to the color coded terminal on the left.

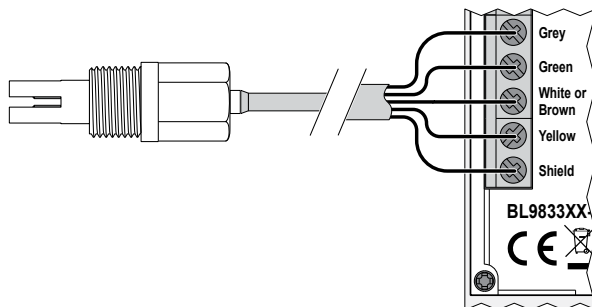

Note: Calibrate the probe prior to measurement.

6. FUNCTIONAL DESCRIPTION

6.1. FRONT PANEL

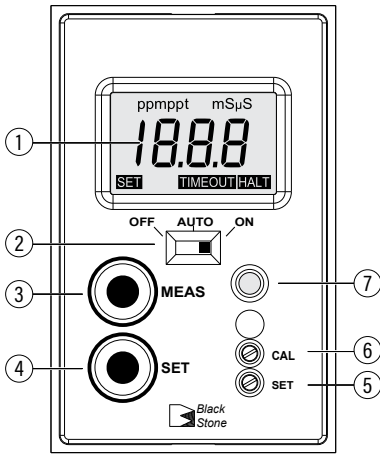

1. LCD
2. Dosing switch
 - OFF (dosing disabled)
 - AUTO (automatic dosing, setpoint value)
 - ON (dosing enabled)
3. MEAS key (measurement mode)
4. SET key (configure display value)
5. SET trimmer (adjust setpoint value)
6. CAL trimmer
7. LED operational indicator
 - Green – measurement mode
 - Orange-Yellow – active dosing
 - Red (blinking) – alarm condition

6.2. REAR PANEL

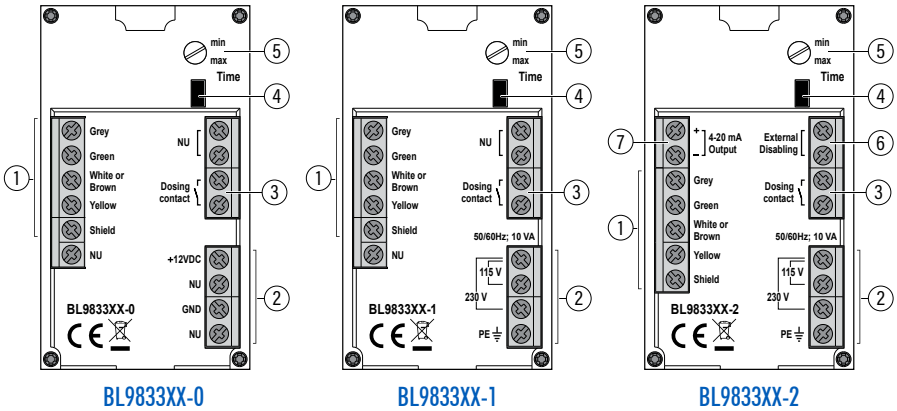

1. Probe connection terminal, low voltage connections
2. Power supply terminal
 - BL9833XX-1 & BL9833XX-2, line voltage connections, 115/230 VAC
 - BL9833XX-0, low voltage connections, 12 VDC
3. Relay contact acts as a switch for driving the dosing system
4. Jumper for enabling (jumper inserted) or disabling (jumper removed) the overtime control
5. Trimmer for overtime setting (approx. from 5 to 30 minutes)
6. External control for dosing system disabling (BL9833XX-2)
7. 4-20 mA output contacts (BL9833XX-2)

7. INSTALLATION

7.1. UNIT MOUNT

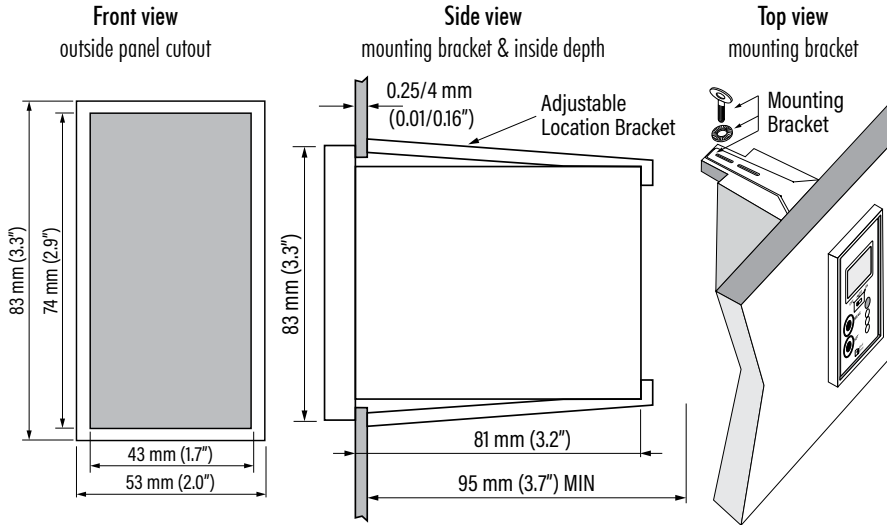

WARNINGS



All external cables connected to the rear panel should be fitted with cable lugs.

A clearly marked disconnect switch (max. 6A) must be installed in the vicinity of the instrument to ensure that the electrical circuit is completely de-energized for service or maintenance.

7.2. REAR PANEL CONNECTIONS

Probe terminal

- Follow color code to connect the probe.

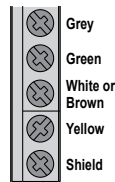

Power supply terminal

- [BL9833XX-0](#)

Connect the 2 wires of a 12 VDC power adapter to the +12 VDC and GND terminals.

- [BL9833XX-1](#) & [BL9833XX-2](#)

Connect a 3-wire power cable paying attention to the correct contacts:

- earth (PE)
- line (L), 115 VAC or 230 VAC
- neutral (N1 for 115 V or N2 for 230 V)

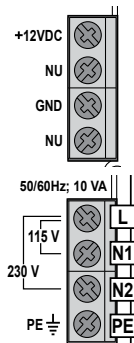

Dosing Contact

- Dosing contact (NO) output drives the dosing system as per configured setpoint.

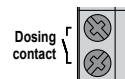

Overtime feature (system control)

- This feature is provided to set the maximum continuous time the relay is running a pump or valve, by adjusting the trimmer (from approx. 5 minutes minimum, to approx. 30 minutes maximum).
- When the set time expires, dosing stops, the LED operational indicator turns red (blinking), and “TIMEOUT” message is displayed. To exit, set the dosing switch to **OFF** then **Auto**.
- Remove the jumper from the rear panel to disable the feature.

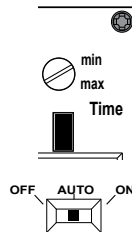

Note: Ensure the dosing switch (front panel) is on Auto for the Overtime feature to be enabled.

External Disabling Contact (NO)

- Normally Open: dosing is enabled.
- Closed: dosing stops, the LED indicator turns red (blinking) and the “HALT” warning message is displayed.



Note: If the dosing switch is ON, dosing continues even with the external disabling contact closed.

Output terminal: 4-20 mA

- Connect process control signal output

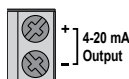

8. OPERATIONS

Hanna® EC and TDS mini controller series are intended to be used to control industrial processes. Relays and Outputs are used to interact with valves or pumps to monitor a process.

8.1. CALIBRATION

1. If the instrument is not in measurement mode, press MEAS key.
2. Immerse the probe in calibration solution. See below table for recommended calibration solutions.
3. Shake briefly and allow reading to stabilize.
4. Adjust the CAL trimmer until the LCD displays the nominal value given here:

	Series	Calibration Solution	Read Value
	BL983313	1413 μ S/cm (HI7031)	1413 μ S
	BL983317	5.00 mS/cm (HI7039)	5.00 mS
EC	BL983320	84 μ S/cm (HI7033)	84.0 μ S
	BL983322	custom calibration solution about 13 μ S/cm or higher	EC solution value
	BL983327	5.00 mS/cm (HI7039)	5.00 mS
	BL983315	84 μ S/cm (HI7033)	42.0 ppm
	BL983318	6.44 ppt (HI7038)	6.44 ppt
TDS	BL983319	1413 μ S/cm (HI7031)	919 ppm
	BL983321	custom calibration solution about 13 ppm or higher	TDS solution value
	BL983324	84 μ S/cm (HI7033)	42.0 ppm
	BL983329	1413 μ S/cm (HI7031)	706 ppm

8.2. SETPOINT CONFIGURATION

General: a set point is a threshold value that will trigger control if the measurement value crosses it.

1. Press the **SET** key. The LCD displays the default or previously configured value along with the "SET" tag.
2. Use a small screwdriver to adjust the **SET** trimmer to the desired setpoint value.
3. After 1 minute the instrument resumes measure mode. If not, press the **MEAS** key.

Note: *The setpoint has a typical hysteresis value comparable to the instrument's accuracy.*

8.3. MONITORING

Best practices

- Ensure wiring is done correctly.
- Ensure setpoint value is configured correctly.
- Ensure probe calibration.
- Select dosing mode.

Procedure

1. Immerse (or install) the probe in the solution to be monitored.
2. Press the **MEAS** key (if necessary). The LCD displays the measured value.
 - LED indicator lights up Green indicating instrument is in measurement mode and dosing is not active.
 - LED indicator lights up Orange/Yellow indicating dosing in progress.

8.4. PROBE MAINTENANCE

Regular cleaning and correct storage is the best way to maximise probe's life.

- Immerse the tip of the probe in [HI7061](#) Cleaning Solution for 1 hour.
- If a more thorough cleaning is required, brush the metal pins with very fine sandpaper.
- After cleaning, rinse the probe with tap water and recalibrate the meter.
- Store the probe clean and dry.

9. ACCESSORIES

Ordering Codes	Description
HI7632-00	EC/TDS probe for high range mini controllers with 2 m (6.6') cable
HI7632-00/6	EC/TDS probe for high range mini controllers with 6 m (19.7') cable
HI7634-00	EC/TDS probe for low range mini controllers with 2 m (6.6') cable
HI7634-00/4	EC/TDS probe for low range mini controllers with 4 m (13.1') cable
HI7634-00/5	EC/TDS probe for low range mini controllers with 5 m (16.4') cable
HI70031P	1413 $\mu\text{S}/\text{cm}$ conductivity standard solution, 20 mL sachet (25 pcs.)
HI7031M	1413 $\mu\text{S}/\text{cm}$ conductivity standard solution, 230 mL
HI7031L	1413 $\mu\text{S}/\text{cm}$ conductivity standard solution, 500 mL
HI7033M	84 $\mu\text{S}/\text{cm}$ conductivity standard solution, 230 mL
HI7033L	84 $\mu\text{S}/\text{cm}$ conductivity standard solution, 500 mL
HI70038P	6.44 g/L (ppt) TDS standard solution, 20 mL sachet (25 pcs.)
HI70039P	5000 $\mu\text{S}/\text{cm}$ conductivity standard solution, 20 mL sachet (25 pcs.)
HI7039M	5000 $\mu\text{S}/\text{cm}$ conductivity standard solution, 250 mL
HI7039L	5000 $\mu\text{S}/\text{cm}$ conductivity standard solution, 500 mL
HI7061M	Cleaning solution for general use, 230 mL
HI7061L	Cleaning solution for general use, 500 mL
HI710005	Power adapter, 115 VAC to 12 VDC, US plug
HI710006	Power adapter, 230 VAC to 12 VDC, European plug
HI710012	Power adapter, 230 VAC to 12 VDC, UK plug
HI731326	Calibration screwdriver (20 pcs.)
HI740146	Mounting brackets (2 pcs.)

CERTIFICATION

All Hanna® instruments conform to the CE European Directives.

Disposal of Electrical & Electronic Equipment. The product should not be treated as household waste. Instead, hand it over to the appropriate collection point for the recycling of electrical and electronic equipment, which will conserve natural resources.

Ensuring proper product disposal prevents potential negative consequences for the environment and human health. For more information, contact your city, your local household waste disposal service, or the place of purchase.



RECOMMENDATIONS FOR USERS

Before using this instrument, make sure that it is entirely suitable for your specific application and for the environment in which it is used. Any variation introduced by the user to the supplied equipment may degrade the instrument's performance. For your and the instrument's safety do not use or store the instrument in hazardous environments.

WARRANTY

The mini controllers are warranted for a period of two years against defects in workmanship and materials when used for their intended purpose and maintained according to instructions. This warranty is limited to repair or replacement free of charge. Damage due to accidents, misuse, tampering, or lack of prescribed maintenance is not covered. If service is required, contact your local Hanna Instruments® office.

If under warranty, report the model number, date of purchase, serial number and the nature of the problem. If the repair is not covered by the warranty, you will be notified of the charges incurred. If the instrument is to be returned to Hanna Instruments office, first obtain a Returned Goods Authorization (RGA) number from the Technical Service department and then send it with shipping costs prepaid. When shipping any instrument, make sure it is properly packaged for complete protection.