

SALES AND TECHNICAL SERVICE CONTACTS

Australia:

Tel. (03) 9769.0666 • Fax (03) 9769.0699

China:

Tel. (10) 88570068 • Fax (10) 88570060

Egypt:

Tel. & Fax (02) 2758.683

Germany:

Tel. (07851) 9129-0 • Fax (07851) 9129-99

Greece:

Tel. (210) 823.5192 • Fax (210) 884.0210

Indonesia:

Tel. (21) 4584.2941 • Fax (21) 4584.2942

Japan:

Tel. (03) 3258.9565 • Fax (03) 3258.9567

Korea:

Tel. (02) 2278.5147 • Fax (02) 2264.1729

Malaysia:

Tel. (603) 5638.9940 • Fax (603) 5638.9829

Singapore:

Tel. 6296.7118 • Fax 6291.6906

South Africa:

Tel. (011) 615.6076 • Fax (011) 615.8582

Taiwan:

Tel. 886.2.2739.3014 • Fax 886.2.2739.2983

Thailand:

Tel. (662) 619.0708.11 • Fax (662) 619.0061

United Kingdom:

Tel. (01525) 850.855 • Fax (01525) 853.668

USA:

Tel. (401) 765.7500 • Fax (401) 765.7575

MAN83749R1
11/05

For e-mail contacts and a complete list of Sales and Technical offices, please see
www.hannainst.com.

Instruction Manual

HI 83749 Turbidity & Bencotest



HANNA[®]
instruments
www.hannainst.com

Dear Customer,

Thank you for choosing a Hanna Instruments product. This manual will provide you with the necessary information for correct use of the instrument.

Please read this instruction manual carefully before using the instrument.

If you need additional technical information, do not hesitate to e-mail us at tech@hannainst.com or see the back side of this manual for our worldwide sales and technical service contacts.

This instrument is in compliance with **CE** directives.

TABLE OF CONTENTS

WARRANTY	2	DETERMINATION OF BENTONITE	
PRELIMINARY EXAMINATION	3	REQUIREMENT	20
GENERAL DESCRIPTION	4	LOGGING	24
ABBREVIATIONS	5	GOOD LABORATORY PRACTICE (GLP)	27
PRINCIPLE OF OPERATION	6	SETUP	29
MEASUREMENT UNITS	6	LCD BACKLIGHT	35
SPECIFICATIONS	7	TAG INSTALLATION	35
FUNCTIONAL DESCRIPTION	8	LAMP REPLACEMENT	35
GENERAL TIPS FOR AN ACCURATE		BATTERIES MANAGEMENT	36
MEASUREMENT	10	ERROR CODES	37
CALIBRATION PROCEDURE	12	PC INTERFACE	38
TURBIDITY MEASUREMENT	16	CE DECLARATION OF CONFORMITY	38
BENTOCHCK (PROTEIN STABILITY TEST) ...	18	ACCESSORIES	39

WARRANTY

HI 83749 is warranted for two years against defects in workmanship and materials when used for its intended purpose and maintained according to instructions. This warranty is limited to repair or replacement free of charge.

Damage due to accidents, misuse, tampering or lack of prescribed maintenance is not covered.

If service is required, contact the dealer from whom you purchased the instrument. If under warranty, report the model number, date of purchase, serial number and the nature of the failure. If the repair is not covered by the warranty, you will be notified of the charges incurred. If the instrument is to be returned to Hanna Instruments, first obtain a Returned Goods Authorization number from the Technical Service Department and then send it with shipping costs prepaid. When shipping any instrument, make sure it is properly packed for complete protection.

To validate your warranty, fill out and return the enclosed warranty card within 14 days from the date of purchase.

ACCESSORIES

HI 83749-20	Bentochek (100 mL)
HI 93703-58	Silicone oil (15 mL)
HI 83749-11	Calibration cuvetts kit
HI 731331	Glass cuvetts (4 pcs)
HI 731335N	Caps for cuvetts (4 pcs)
HI 93703-50	Cuvetts cleaning solution (230 mL)
HI 731318	Tissue for wiping cuvetts (4 pcs)
HI 740220	25 mL glass vial with cap (2 pcs)
HI 731341	Automatic pipette 1000 μ L
HI 731351	Tips fo automatic pipette 1000 μ L (25 pcs)
HI 740233	Filter paper type II (100 pcs)
HI 740142P	1 mL graduated syringe (10 pcs)
HI 740144P	Tips for 1 mL syringe (10 pcs)
HI 740234	Replacement lamp for EPA turbidimeter (1 pcs)
HI 92000	Windows® compatible software
HI 920011	RS232 connection cable
HI 920005	5 tag holders with tags
HI 740027P	1.5V AA battery (12 pcs)
HI 710005	Voltage adapter from 115V to 12 VDC (USA plug)
HI 710006	Voltage adapter from 230V to 12 VDC (European plug)
HI 710012	Voltage adapter from 240V to 12 VDC (UK plug)
HI 710013	Voltage adapter from 230V to 12 VDC (South Africa plug)
HI 710014	Voltage adapter from 230V to 12 VDC (Australia plug)

Hanna Instruments reserves the right to modify the design, construction and appearance of its products without advance notice.

PC INTERFACE

To fully use the instrument tag identification system function, the measured data has to be downloaded to a computer. The instrument can use RS232 or USB connection to communicate with the PC.

When using the RS232 protocol, simply connect a **HI 920011** serial cable between the instrument and the computer.

To use the USB protocol, simply connect a regular USB cable between instrument and PC.

In both cases, the PC must run the **HI 92000** application for successful data transfer.

CE DECLARATION OF CONFORMITY

Recommendations for Users

Before using these products, make sure that they are entirely suitable for your specific application and for the environment in which they are used.

Operation of these instruments may cause unacceptable interferences to other electronic equipments, this requiring the operator to take all necessary steps to correct interferences.

Any variation introduced by the user to the supplied equipment may degrade the instruments' EMC performance.

To avoid damages or burns, do not put the instrument in microwave ovens. For yours and the instrument safety do not use or store the instrument in hazardous environments.

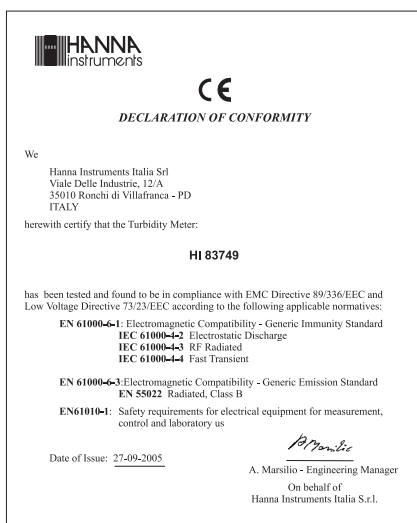

PRELIMINARY EXAMINATION

Please examine this product carefully. Make sure the instrument is not damaged. If any damage has occurred during the shipment, please notify your dealer.

This **HI 83749 Turbidity & Benticheck Meter** is supplied complete with:

- Six Sample Cuvets and Caps
- Four Calibration Cuvets (**HI 83749-11**)
- Benticheck Reagent (**HI 83749-0**) and Silicone Oil (**HI 93703-58**)
- One 1000 μ L Automatic Pipette with two Tips and Instructions Sheet
- Four 25 mL Glass Vials with Caps
- One 1 mL Syringe with two Tips; one Funnel; Filter Paper (25 pieces).
- Five Tag Holders with Tags (**HI 920005**)
- Tissue for wiping the cuvetts
- Four 1,5V AA Batteries
- AC Adapter
- Instruction Manual
- Instrument Quality Certificate
- Rigid carrying case

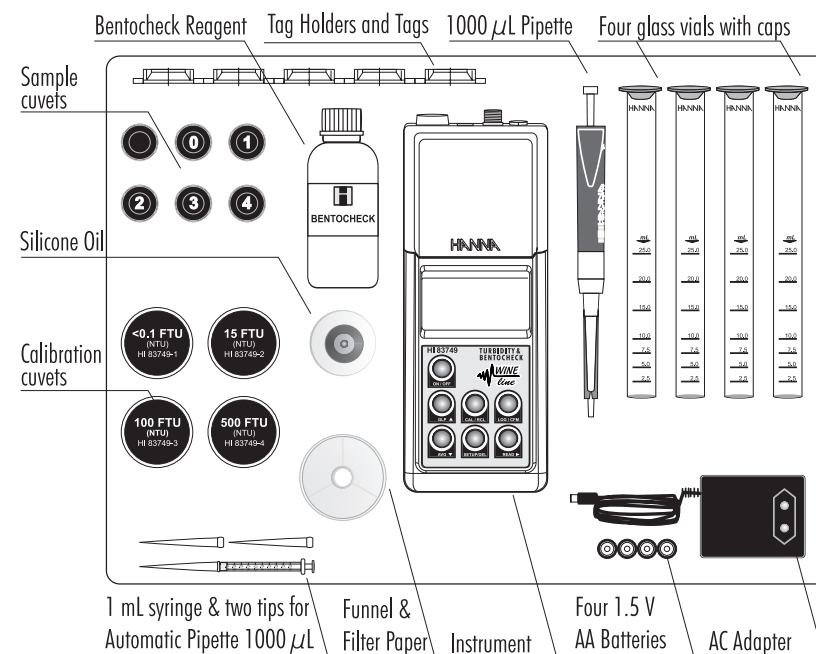

Note: Save all packing material until you are sure that the instrument works correctly. Any defective item must be returned in the original packing with the supplied accessories.

GENERAL DESCRIPTION

The **HI 83749** is an auto diagnostic microprocessor meter that benefits from Hanna's years of experience as manufacturer of analytical instruments.

The meter is especially designed for wine analyses and, beside turbidity measurements, it allows to make tests to verify protein stability (e.g. Benticheck).

The instrument compensates wine color to guarantee accurate readings during the vinification process; also for the darkest red wine samples. The optical system, consisting of a tungsten filament lamp and multiple detectors, assures long term stability and minimizes the need of frequent calibration. Calibration can be anyway easily performed at any time in two, three or four points (<0.1, 15, 100 and 500 NTU-adjustable calibration points), using the supplied or user prepared standards.

The meter has all necessary GLP (Good Laboratory Practice) functions to allow maximum traceability of data like a real time clock, log-on-demand (up to 200 measurements), and T.I.S. -Tag Identification System to give all recorded data a location, time and date stamp.

The meter measures turbidity of samples from 0.00 to 1200 NTU (Nephelometric Turbidity Units) and is USEPA compliant. In the USEPA measurement mode the instrument rounds the readings to meet USEPA reporting requirements. It has a continuous measurement mode to verify the settling rate of suspended matter, and a signal average (AVG) mode to accumulate multiple readings giving a final average value. The AVG routine is particularly useful to measure samples with suspended particles with different dimensions.

The **HI 83749** has a user-friendly interface, with a large backlit LCD (Liquid Crystal Display). Acoustic signals and displayed codes to guide the user step by step through routine operations.

This valuable splash proof portable turbidity meter is supplied in a rigid carrying case that offers protection for harsh environments.

BENTOCHECK

The prevention of protein haze or deposit in bottled **white wines** is a universal concern and often a wine needs to be stabilized before bottling. One commonly used stabilization agent is bentonite. Bentonite is a volcanic clay earth type fining agent (like kaolin). It improves the clarity and stability of wine but has also negative aspects because of the volume of lees formed, reduction of tannin and color. Since there are different types and qualities of bentonite with different capacity of protein removal, it is important to make laboratory trails with the same lot and wetting degree of the bentonite as that will be used in the cellar.

Protein stabilization is normally not a problem in bottled red wines because of the relatively high concentration of phenols that binds and precipitates with the instable proteins before bottling. Often bentonite is added to red wines at a level of about 12 g/hL (1 lb/1000 gal), reducing colloidal suspended particles thus improving membrane filterability.

Wines with low phenols contents, such as rose, light reds and whites should be checked for protein stability before bottling. Hanna is offering a rapid test to verify the risk of future protein haze formation.

USING AN AC ADAPTER

In laboratory you can use an AC adapter to power the **HI 83749**. Simply connect the AC adapter to the instrument (see Connectors Description, page 9).

It is not necessary to turn the instrument off when connecting the external adapter.

Note: The connection to the external adapter will not recharge the batteries.

ERROR CODES

HI 83749 has a powerful diagnostic system. Common errors are detected and reported for easy diagnostic and maintenance.

ERROR	DESCRIPTION	ACTION
Err1 – Err3; Err6; Err7; Err8	Critical errors. The instrument beeps and shuts down.	Contact your nearest HANNA Customer Service Center
Err4	The instrument beeps shortly twice and shuts down after 10 seconds.	Press simultaneously UP and DOWN to reset
CAP	The lid is not closed.	Close the lid. If the error persists, contact your nearest HANNA Customer Service Center
no L	Lamp broken or no light.	Check the optical system for obstructions. Replace the lamp.
L Lo	Not enough light.	Check the optical system for obstructions.
-LO-	The standard used for current calibration point is too low.	Check the standard and use the correct one.
-HI-	The standard used for current calibration point is too high.	Check the standard and use the correct one.
Battery tag blinking	The remaining battery life is too low.	Replace batteries.
bAtt	The batteries are too discharged for correct measurements.	Replace batteries.

BATTERIES MANAGEMENT

For field measurements, HI 83749 is powered by 4 AA batteries. The battery life is enough for 1500 normal measurements.

When you turn the instrument on, the remaining battery life is estimated and reported in percents.

To save the battery life, the instrument will turn off after 15 minutes of non-use. The backlight will be turn off after 25 seconds since the last key was pressed.

The battery life is measured each time the lamp is turned on and if the remaining battery life is less than 10%, the battery tag will blink on the LCD to advise the user to replace the batteries.

When the batteries are completely discharged, "0% bAtt" message will be displayed for one second and the instrument will turn off.

In order to use the instrument again, replace the batteries or use an AC adapter.

BATTERIES REPLACEMENT

To replace the batteries follow the next steps:

- Turn OFF the instrument by pressin ON/OFF.
- Open the batteries cover by pressing the locking clip.

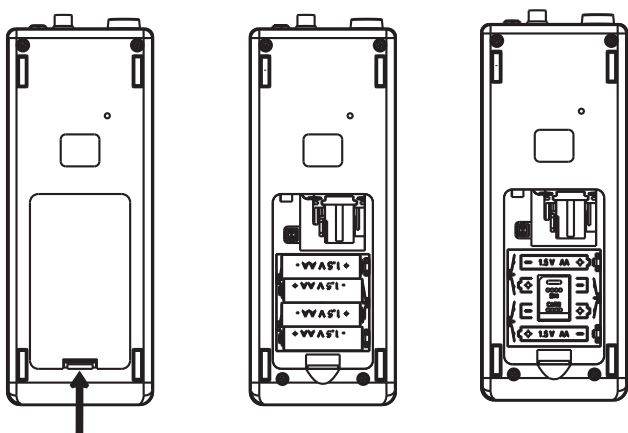

- Take out the used batteries and insert 4 new 1.5 AA size batteries, paying attention to the correct polarity as indicated on the battery compartment.
- Replace the cover and press it until it locks.

Warning: Replace batteries only in a non-hazardous area.

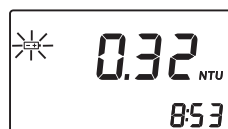
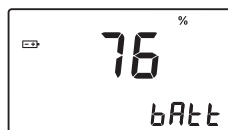

If protein instability is detected, a next test can help defining the right amount of bentonite to be added for improving protein stability. It is important not to overdose bentonite, avoiding stripping wine flavour, body, and significant loss of color, especially in young red wines. Moreover, adding only the necessary amount of bentonite to obtain the desired protein stability is also costs saving.

TAG IDENTIFICATION SYSTEM

Hanna is the first manufacturer of turbidity instruments that has decided to add the unique T.I.S. - Tag Identification System to portable turbidity meters, to meet the more restrictive needs for traceability and data management of our clients.

The system is designed for scientific and industrial applications, or to prove during safety audits and inspections that samples have been truly taken on pre-established locations.

The system is as easy to install as to operate. Just fix the so-called iButton® tags near your sampling sites that need to be checked often, and with this the T.I.S. is setup. The tag contains a computer chip embedded in a durable stainless steel can. It is designed to withstand the harsh environments, indoors or outdoors. The number of tags that can be installed is practically unlimited, because each tag has a unique identification code.

Immediately after installation of the tags you can start collecting data. Use the meter to take measurements and memorize the test result by pressing the Log-on-Demand key. Then, the instrument will ask for the tag identification. Simply touching the iButton® with the matching connector on the meter does identify and authenticate logging, by storing the iButton® serial number, time and date stamp events.

The power of the T.I.S. features resides in the PC application. Download all test data to your PC and use our HI 92000 Windows® compatible application software for further data management. You can sort or filter all your collected data on different criteria like on a specific sampling location, parameter, date and time intervals, or fix range to filter measured values. The data can be plotted in a graph, exported to other common Windows® applications or printed for reporting purpose.

It is also possible to add new tags later on, thus increasing an already existing database. Each time the PC software recognizes a not already registered tag, it will ask for a description of the new sampling location.

ABBREVIATIONS

NTU	Nephelometric Turbidity Units
FTU	Formazin Turbidity Units
USEPA	US Environmental Protection Agency
LCD	Liquid Crystal Display
RTC	Real Time Clock
T.I.S.	Tag Identification System

iButton® is registered Trademark of "MAXIM/DALLAS semiconductor Corp."

Windows® is registered Trademark of "MICROSOFT Corporation"

PRINCIPLE OF OPERATION

A light beam that passes through the sample is scattered in all directions. The intensity and pattern of the scattered light is affected by many variables like wavelength of the incident light, particle size, shape, refractive index and color.

The optical system includes a tungsten filament lamp, a scattered light detector (90°) and a transmitted light detector (180°). The microprocessor of the instrument calculates the NTU value from the signals that reaches the two detectors.

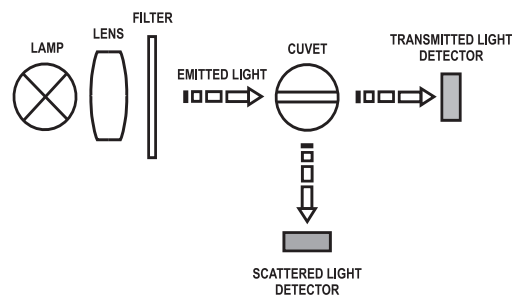

The lower detection limit of a turbidimeter is determined by the so called “stray light”. Stray light is the light detected by the sensors, that is not caused by light scattering from suspended particles.

The optical system of **HI 83749** turbidimeter is designed to have very low stray light, providing accurate results also for low turbidity samples. However, special care must be taken when measuring low turbidities (see General Tips for an Accurate Measurement, page 10).

MEASUREMENT UNITS

Many methods were used to measure turbidity over the years. The Jackson Candle Turbidimeter was used to measure turbidity as Jackson turbidity units (JTU). The Secchi Disk is commonly used to measure turbidity in lakes and other deep waters (mg/L SiO₂). Both methods are visual and are not considered very accurate. To obtain more accurate readings a nephelometer should be used as a turbidity reading instrument.

The **HI 83749** turbidimeter reports the measurements in NTU (Nephelometric Turbidity Units). NTU units are equal to FTU units (Formazine Turbidity Units). The conversion table between these measurement units is shown below:

	JTU	NTU/FTU	SiO ₂ (mg/L)
JTU	1	19	2.50
NTU/FTU	0.053	1	0.13
SiO ₂ (mg/L)	0.4	7.5	1

LCD BACKLIGHT

The LCD can be illuminated to allow the user to see the readings even in dark environments.

To turn on or off the backlight, press the ON/OFF key.

The backlight will automatically shut-off after 25 seconds of non-use to save the battery life.



TAG INSTALLATION

The tag is housed in a rugged metal that can withstand harsh environments. However, it is better to protect the tag from direct rain.

Place the tag near a sampling point. Fix it securely with the provided screws, in such a way that the metallic iButton® is easily accessible for reading the tag.

The number of tags that can be installed is practically unlimited. Additional tags can be ordered

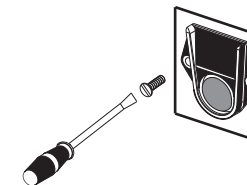

(See Accessories, page...) **HI 920005** - five tag holders with tags).

LAMP REPLACEMENT

The instrument tungsten lamp has a life longer than 100,000 measurements. In case of lamp failure, the defective lamp can be easily replaced. When the lamp is broken, the instrument displays “no L” error message.

To replace the lamp follow the next steps:

- Remove the battery lid.
- Unscrew the lamp connection using a screwdriver.
- Unlock the lamp and extract it by pulling it out from the lamp holder handler.
- Place the new lamp in the right position and push it until is securely locked.
- Insert the lamp leads into the connector and tight them using a screwdriver.

Warning: After lamp replacement the meter needs to be recalibrated.

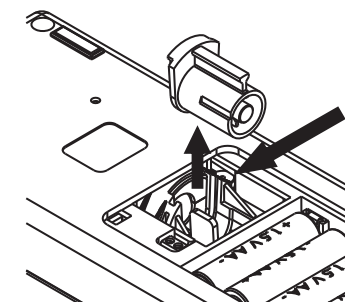

SET INSTRUMENT ID

The instrument ID is a four digit number that can be edited by the user. The instrument ID is downloaded on the PC application, together with the logged data. By setting a different ID for each instrument it is possible to mix information from many turbidimeters into the same database.

- To set the instrument ID, press CAL/RCL when the "Set instrument ID" panel is displayed. The default instrument ID is 0000. The existing ID value and the CFM tag will start blinking.
- Press the UP or DOWN keys to set the new instrument ID. By pressing and holding the UP or DOWN keys, the changing speed will increase.
- Press LOG/CFM to save the change. The new instrument ID will be displayed. Alternatively, press CAL/RCL to exit without saving the changes.

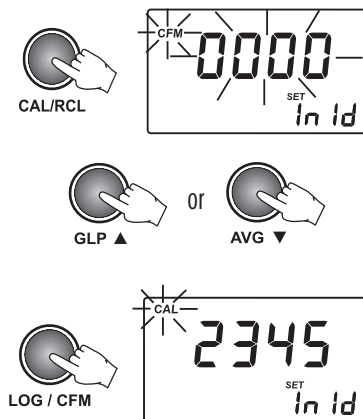

SET BAUD RATE

The HI 83749 has a RS232 and a USB link. When the USB connection is used, the RS232 connection becomes inactive.

To successfully communicate with the PC, the same baud rate must be selected on the instrument and on the PC application. The available baud rates are 1200, 2400, 4800 and 9600.

- To set the baud rate, press CAL/RCL when the "Set baud rate" panel is displayed. The parameter value and the CFM tag will start blinking.
- Press the UP or DOWN keys to select the new baud rate value.
- Press LOG/CFM to save the change. The new selected baud rate will be displayed. Alternatively, press CAL/RCL to exit without saving the changes.

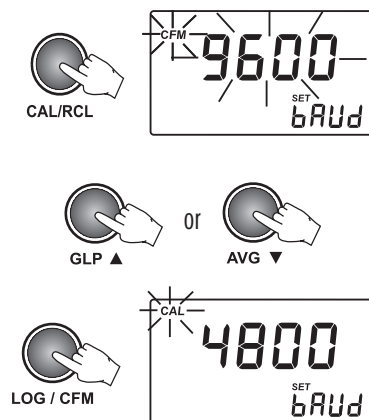

SPECIFICATIONS

Range	0.00 to 9.99 NTU 10.0 to 99.9 NTU 100 to 1200 NTU
Range Selection	Automatically
Resolution	0.01 NTU from 0.00 to 9.99 NTU 0.1 NTU from 10.0 to 99.9 NTU 1 NTU from 100 to 1200 NTU
Accuracy	±2% of reading plus 0.05 NTU
Repeatability	±1% of reading or 0.02 NTU, whichever is greater
Stray Light	< 0.05 NTU
Light Source	Tungsten filament lamp
Light Detector	Silicon Photocell
Method	Ratio Nephelometric Method.
Display	60 x 90mm backlit LCD
Calibration	Two, three or four points calibration
LOG Memory	200 records
Serial Interface	RS232 or USB 1.1
Environment	0 to 50°C (32 to 122°F); max 95% RH non-condensing
Power supply	4 x 1.5V AA alkaline batteries or AC adapter
Auto Shut-off	After 15 minutes of non-use
Dimensions	224 x 87 x 77 mm (8.8 x 3.4 x 3.0")
Weight	512 g (18 oz.)

FUNCTIONAL DESCRIPTION

INSTRUMENT DESCRIPTION

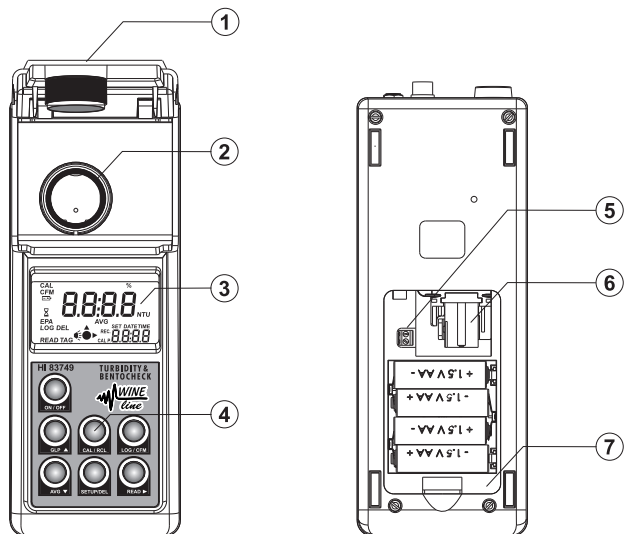

- 1) Cuvet Lid.
- 2) Cuvet Holder.
- 3) Backlit Liquid Crystal Display (LCD).
- 4) Splash proof keypad.
- 5) Lamp connector.
- 6) Lamp Holder.
- 7) Battery Compartment.

KEYPAD DESCRIPTION

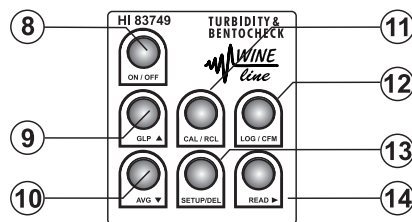

- 8) ON/OFF: this is a bi-functional key. Just press to turn the instrument on or to activate the back light. Hold the key for 3 seconds to turn the instrument off.
- 9) GLP ▲: press to enter/exit GLP (Good Laboratory Practice) feature. In Setup this key is used to increase the set values. In Log Recall it is used to select a new record (scroll up).
- 10) AVG ▼: press to select the AVG (Signal Average Mode) on and off. In Setup it is used to decrease the set values. In Log Recall it is used to select a previous record (scroll down).

- Press LOG/CFM or READ ► to start editing the day value. The day value will start blinking.

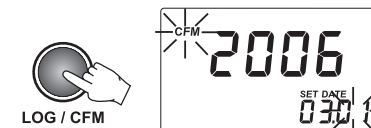

- Press the UP or DOWN keys to set the day value.
Note: to edit the year again, after the day was set, press READ ►.

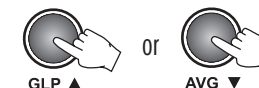

- Press LOG/CFM to save the new date. The new date will be displayed on the LCD. Alternatively, press CAL/RCL to exit without saving the changes.

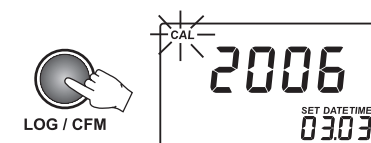

SET THE TIME

- To set the current time, press CAL/RCL when the "Set time" panel is displayed. The time format is hh:mm. The hour value and "CFM" tag will start blinking.

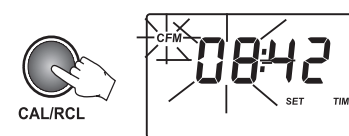

- Press the UP or DOWN keys to set the hour value.

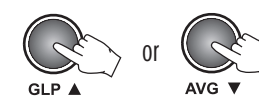

- Press LOG/CFM or READ ► to start editing the minutes. The minutes value will start blinking.

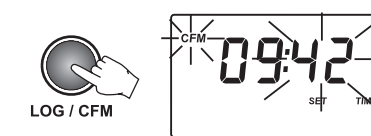

- Press the UP or DOWN keys to set the minutes value.

Note: To edit the hour again, after the minutes were edited, press READ ►.

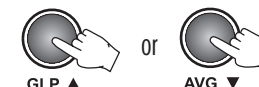

- Press LOG/CFM to save the new time. The new set time will be displayed. Alternatively, press CAL/RCL to exit without saving the changes.

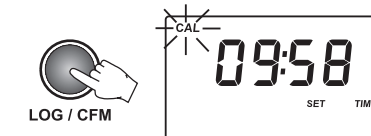

SHOW / HIDE THE TIME

You can choose between showing or hiding the current hour and minutes on the secondary LCD.

- To set hiding or showing the time, press CAL/RCL when the "Show/hide time" panel is displayed. The time show status and the CFM tag will start blinking.
- Press the UP or DOWN keys to set Lcd / hide for time.
- Press LOG/CFM to save the change. The new selected option will be displayed on the LCD. Alternatively, press CAL/RCL to exit without saving the changes.

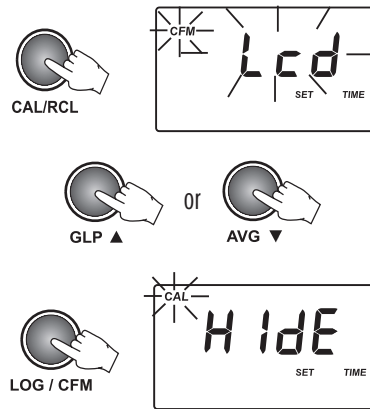

SET THE DATE

The HI 83749 turbidimeter has a built-in real time clock (RTC). The RTC time is used to generate a unique time stamp for each recorded value and to automatically store the last calibration date. The current time can be displayed on the LCD when the instrument is in measurement mode.

- To set the current date, press CAL/RCL when the "Set date" panel is displayed. The date format is YYYY.MM.DD. The last two digits of the year value and CFM tag will start blinking.
- Press the UP or DOWN keys to set the year value.
- Press LOG/CFM or READ ► to start editing the month value. The month value will start blinking.
- Press the UP or DOWN keys to set the month value.

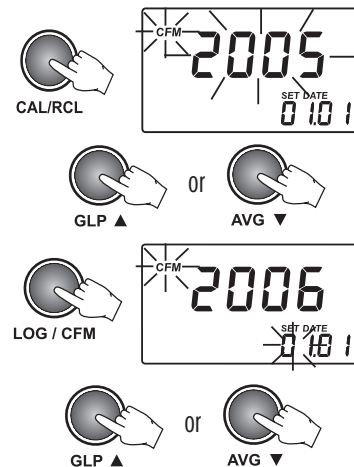

- CAL/RCL: this is a bi-functional key. Just press to enter/exit calibration or in setup mode to start/stop editing a parameter. Hold the key for 3 seconds to enter/exit viewing log content.
- LOG/CFM: press to save a record or to confirm the selected option.
- SETUP/DEL: press to enter/exit setup. The DEL function is available in Log Recall mode to delete one or all records. In GLP it is used to restore factory calibration.
- READ ►: press to start a measurement. Hold the key to make a continuous measurement. In Log Recall mode it is used to view the content of a record. In GLP it is used to view all available information. In Setup, during date or time editing, it is used to select day, month or year and hour/minutes.

CONNECTORS DESCRIPTION

- AC adapter connector.
- RS232 connector, to be used with serial cable to transfer data to PC.
- Tag reader.
- USB connector.

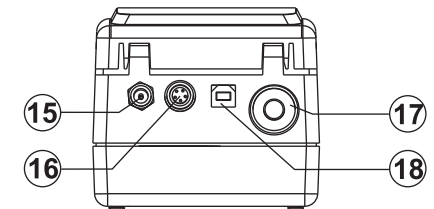

DISPLAY DESCRIPTION

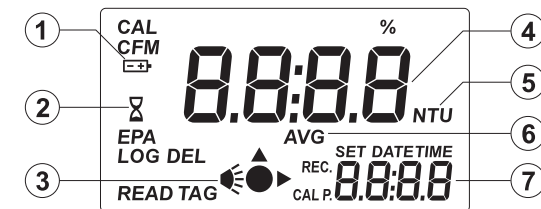

- Battery icon. This icon appears when the status of the battery is displayed or when the battery voltage is getting low.
- Hour glass icon. It is displayed when the instrument performs an internal checkup.
- Lamp and read status indicator.
- Four digit main display.
- NTU measurement units. When average or continuous mode is selected, the "NTU" tag blinks for each new displayed value. For conversions in other units see Measurement Units section.
- AVG icon appears when the Signal Average Mode is selected.
- Four digit secondary display.

BEEPER

A long beep indicates an error or an invalid key pressed. A short beep means that the current operation is confirmed.

GENERAL TIPS FOR AN ACCURATE MEASUREMENT

The instructions listed below should be carefully followed to ensure best accuracy.

GENERAL TIPS

- Always cap the cuvetts to avoid spillage of the sample into the instrument.
- Always close the lid of the instrument during measurement.
- Keep the lid of the instrument closed when it is not used to prevent dust or dirt entering.
- Put always the instrument on a flat, rugged surface when taking measurements.

CUVET

The cuvet is part of the optical system and measurements can be affected by the glass imperfections, dirt, dust, scratches, or fingerprints present on the cuvet surface.

CUVET HANDLING

- Any cuvet with visible scratches must be discarded.
- Always store the cuvetts in separate boxes or with separators between them to avoid scratches on the surface.
- Whenever a cuvet is placed into the instrument, it must be dry outside, free of fingerprints or dirt. Wipe it thoroughly with HI 731318 (tissue for wiping cuvetts, see Accessories Section, page 39) or a lint-free cloth prior to insertion.

CUVET OILING

- For low turbidity readings (<1.0 NTU) the cuvetts should be oiled outside with the supplied **HI 93703-58** Silicone Oil. Use only one single drop of oil and then wipe the cuvet thoroughly with a lint-free cloth.

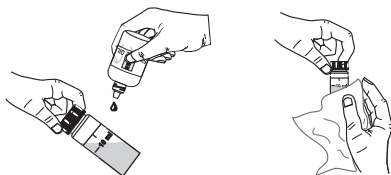

SAMPLING TECHNIQUE

When you make turbidity measurements it is important to take a representative sample.

- Gently mix the sample before filling the cuvet.
- Samples should be analyzed immediately after collection because turbidity can settle or change in time.
- Pay attention when working with cold samples that no condense is formed on the outside of the cuvet. We recommend to work always with samples at room temperature.

SET EPA COMPLIANCE MODE

When EPA compliance reading is on, "EPA" message is displayed on the secondary LCD and the reported values are rounded to meet EPA reporting requirements.



- To edit the EPA mode, press CAL/RCL when EPA compliance reading panel is displayed. The parameter setting and "CFM" tag will start blinking.

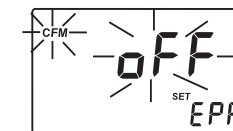

- Press the UP or DOWN keys to set the EPA compliance mode on or off.

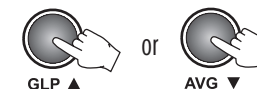

- Press LOG/CFM to save the setting. The new selected option of the parameter will be displayed on the LCD. Alternatively, press CAL to exit without saving the new settings.

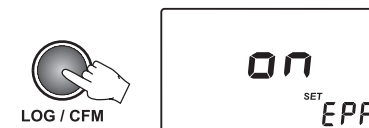

SET BEEPER

The **HI 83749** has a built-in beeper that signals the tag read, the key press and the error conditions. The beeper can be selected to be on or off.

- To set the beeper on or off, press CAL/RCL when set beeper panel is displayed. The beeper status and the CFM tag will start blinking.

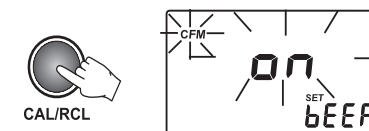

- Press the UP or DOWN keys to set the beeper on or off.

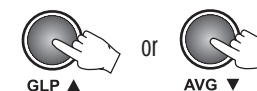

- Press LOG/CFM to save the change. The new selected option will be displayed on the LCD. Alternatively, press CAL to exit without saving the changes.

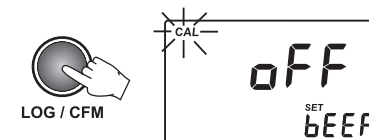

- Add HI 83749-0 Bientochek reagent, mix and wait for 1 minute. Then take a new reading (T2).
- If the difference between T1 and T2 is less than 10%, the instrument gives a beep of 1 second and displays alternating the turbidity value (NTU) and the difference (%).
- If the difference between T1 and T2 is more than 10%, the instrument just displays T2 in the primary LCD and T1 in the secondary LCD.

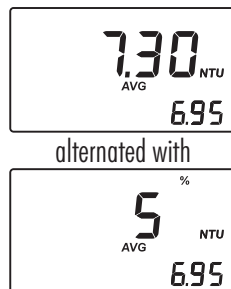

ACTIVATING COMPARATIVE MODE

For the determination of bentonite requirement you can activate Comparative mode for an automatic comparison of turbidity values.

- To edit the Comparative mode, press CAL/RCL when "Activating Comparative mode" panel is displayed. The parameter setting and "CFM" tag will start blinking.

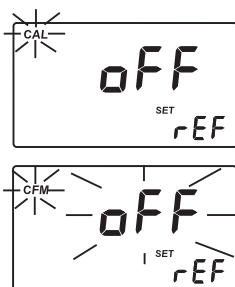

- Press the UP or DOWN keys to set the Comparative mode on or off.

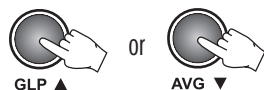

- Press LOG/CFM to save the setting. The new selected option will be displayed on the LCD. Alternatively, press CAL/RCL to exit without saving the new settings.



Note: when Comparative mode is set on, in the Measurement mode, the secondary display will show the reference value

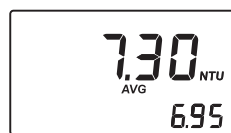

REMOVING AIR BUBBLES

Air bubbles present in the sample will cause erroneous high turbidity readings.

- To remove air bubbles fill the cuvet with wine sample and close the cap tightly. Shake the cuvet gently to create pressure. Allow the cuvet to stand for a few minutes and gently invert it several times. Check that no air bubbles are visible, otherwise shake again and repeat the procedure above.
- Alternatively use an ultrasonic bath to degas the wine sample.

MEASUREMENT TIPS

- For a correct filling of the cuvet: the liquid in the cuvet forms a convexity on the top; the bottom of this convexity must be at the same level of the 10 mL mark.
- For dosing the Bientochek reagent, we recommend to use the supplied Hanna automatic pipette (HI 731341 - 1000 µL). For a correct use of the Hanna automatic pipette, please follow the related Instruction Sheet.



- In order to measure the exact volume of bentonite suspension with the 1 mL syringe, push the plunger completely into the syringe and insert the tip into the solution. Pull the plunger up to above the 0.0 mL mark. Take out the syringe and clean the outside of the syringe tip. Then, adjust the plunger to the 0.0 mL mark (the lower edge of the seal must be exactly on the 0.0 mL mark). Be sure that no drops are hanging on the tip of the syringe, if so eliminate them. Then, to add exactly 0.25 mL of bentonite suspension, keep the syringe in vertical position over the cylinder and push the plunger down until the lower edge of the seal is exactly on the 0.25 mL mark. Now the exact amount of 0.25 mL has been added to the cylinder, even if the tip still contains some solution.

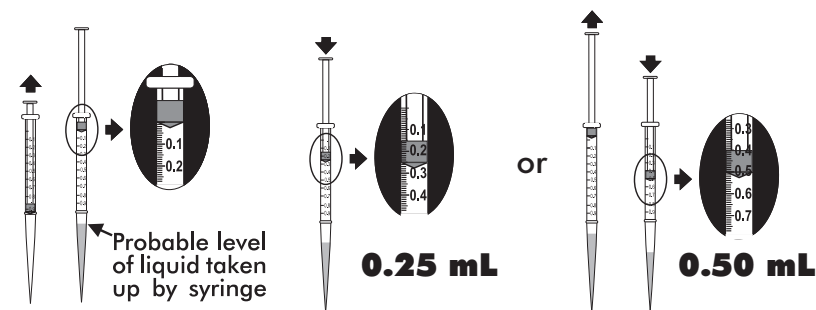

Repeat the entire procedure to measure 0.50 mL, 0.75 mL and 1 mL of bentonite suspension.

CALIBRATION PROCEDURE

It is recommended to calibrate the meter only with Hanna ready-to-use calibration standard solutions. Alternatively, formazin standards can be used. The prepared formazin solutions should be close to the default calibration points. The first point must be near 0 NTU, the second point between 10 and 20 NTU, the third point between 50 and 150 NTU and the fourth point between 400 and 600 NTU.

CALIBRATION

Calibration can be performed in two, three or four points. It is possible to interrupt calibration procedure at any time by pressing ON/OFF.

- Turn the instrument on by pressing ON/OFF. When the LCD displays "----", the instrument is ready.

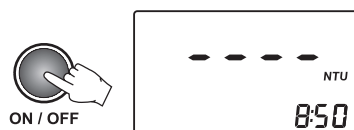

- Enter calibration mode by pressing CAL/RCL. The display will show "CAL P.1".

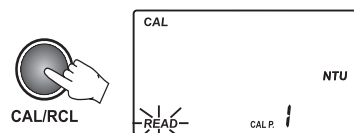

- Place the <math><0.10</math> NTU standard cuvet into the holder.

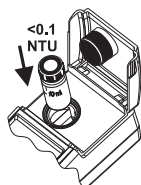

- Close the lid and press READ. "----" and the "Lamp and Read Status" indicator will blink on the display. Alternatively, press LOG/CFM to skip the first calibration point.

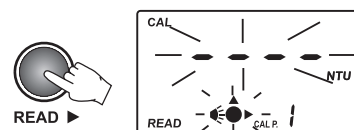

- Then the LCD will show the second calibration point (15.0 NTU) and "CAL P.2", while "READ" is blinking.

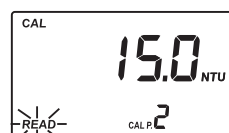

Note: If you're using different calibration standards, change the displayed value by pressing UP or DOWN keys until the display shows the desired value.

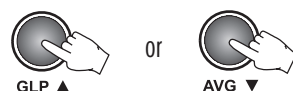

SETUP

The Setup mode allows the user to view and modify the instrument parameters. The blinking "CAL" tag appears during setup mode suggesting to press CAL for editing parameters.

- To enter/exit SETUP, press SETUP/DEL.



- To select the parameter to be edit, press UP or DOWN keys until the desired panel is displayed.

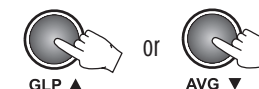

SET REFERENCE VALUE

During determination of bentonite requirement for stabilization of the wine, it can be useful to set a reference value and let the instrument automatically compare turbidity values.

- When the display shows the first reading (T1), you can store the result as Reference Value. Press SETUP/DEL to enter the "Set Reference Value" panel. "CAL" will blink and "SET rEF" will be displayed.

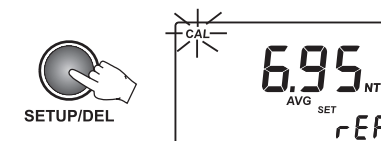

- To set the reference value, press CAL/RCL. Then the value and "CFM" tag will start blinking.

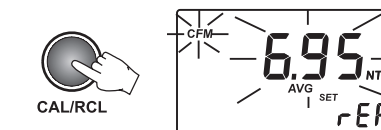

- At this point the displayed reference value can be modified using the UP and DOWN arrow keys.

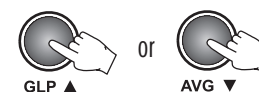

- Press LOG/CFM to store the value. **Note:** To exit without saving the reference value, press SETUP/DEL and the meter will return to the measurement panel.



- To activate the Comparative mode, press the AVG key and set on the Comparative mode (see page 30).

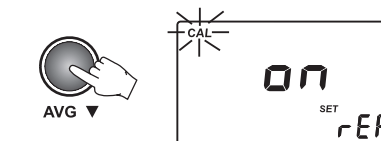

- Press SETUP/DEL to return to Measurement mode. The display will show the reference value.

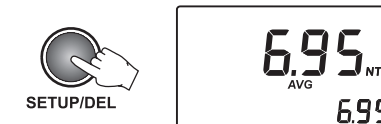

- Third calibration point (if available).
- Fourth calibration point (if available).
- Delete calibration panel.



To delete calibration:

- Press SETUP/DEL when the instrument displays the "Delete calibration" panel. The user calibration will be deleted and the factory calibration will be restored. The instrument will enter automatically in idle mode.

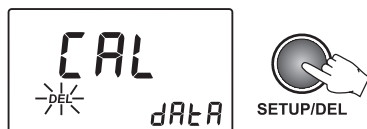

- Remove the <math><0,10</math> NTU standard cuvet and place the 15.0 NTU standard cuvet into the holder.

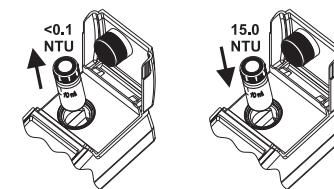

- Close the lid and press READ ►. "----" and the "Lamp and Read Status" indicator will blink again while making the reading.

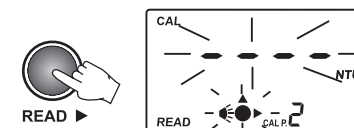

- At the end of the reading, the third calibration point (100 NTU) and "CAL P.3" is displayed. If desired, the value can be changed using the UP or DOWN keys.

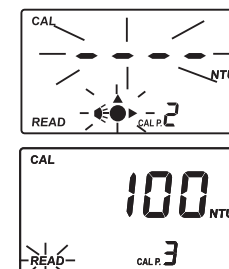

Note: At this moment it is possible to exit calibration by pressing CAL/RCL. The instrument will memorize the two-point (<math><0,10</math> and 15.0 NTU) calibration data and will return to measurement mode.

- Remove the 15.0 NTU standard cuvet from the meter and place the 100 NTU standard cuvet into the holder.

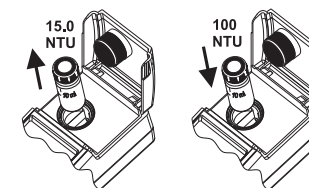

- Close the lid and press READ ►. "----" and the "Lamp and Read Status" indicator will blink again while making the reading.

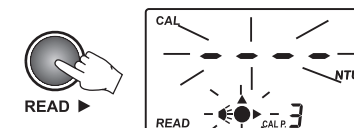

- At the end of the reading, the fourth calibration point (500 NTU) and "CAL P.4" is displayed. If desired, the value can be changed using the UP or DOWN keys.

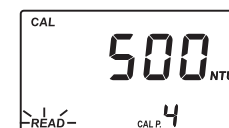

Note: At this moment it is possible to exit calibration by pressing CAL/RCL. The instrument will memorize the three-point (<math><0,10</math>, 15.0 and 100 NTU) calibration data and will return to measurement mode.

- Remove the 100 NTU standard cuvet from the meter and insert the 500 NTU standard cuvet into the holder.

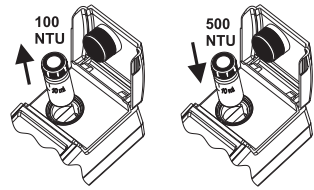

- Close the lid and press READ ►. "----" and the "Lamp and Read Status" indicator will blink again while making the reading.

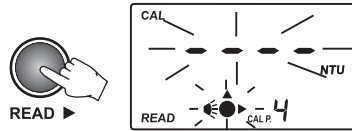

- At the end of the measurement, the four-point calibration is completed and the instrument returns automatically to measurement mode.

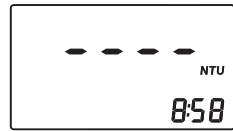

OUT CAL RANGE FUNCTION

The instrument has an **Out Cal Range** function to alert the user (with "cal" blinking message) when a measurement is made outside of the calibration range.

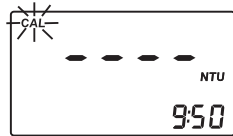

CALIBRATION ERRORS

- If the read value during calibration is too far from the set value, the instrument will show "-LO-" or "-HI-" error.
- If the calculated calibration coefficients are off specifications, the "CAL Err" message is displayed.

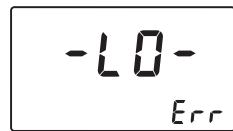

OR

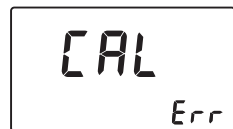
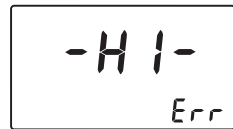

- The instrument asks for confirmation. Press the LOG/CFM key to confirm all records are deleted. To abort the delete function, press READ ► instead of LOG/CFM.



- After all records are deleted the instrument returns to measurement mode.

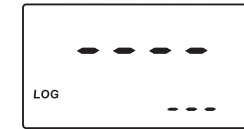

GOOD LABORATORY PRACTICE (GLP)

The GLP feature allows the user to view last calibration data. Also the user calibration can be deleted.

- Press GLP ▲ to enter or exit GLP data consulting. Several functions are available when in GLP menu. Press READ ► to scroll through the GLP data.

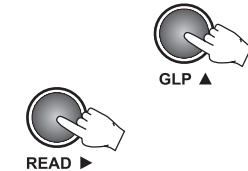

The following GLP panels can be viewed.

- The last calibration date, in YYYY.MM.DD format. If no calibration was performed, the factory calibration message, "F.CAL", will be displayed on the LCD.



- The time of the last calibration in hh:mm format.

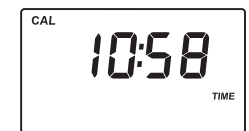

- First calibration point: 0.00 NTU if skipped or the actual read value (e.g. 0.01 NTU).

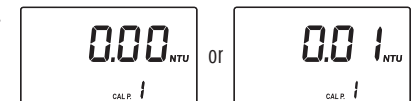

- Second calibration point.

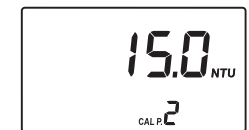

- Measurement date in YYYY.MM.DD format.



- Measurement time in hh:mm format.

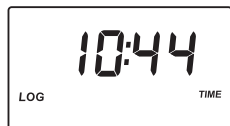

- Delete the last record panel (only for last record).



- Delete all records.



DELETE LAST RECORD

To delete the last record, scroll through the log menu until the delete last record panel is displayed.

- To delete the last record, press SETUP/DEL when the "Delete last records" panel is displayed.

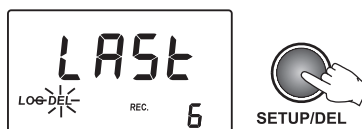

- The instrument asks for confirmation. Press the LOG/CFM key to confirm the last record is deleted. To abort the delete function, press READ ► instead of LOG/CFM.

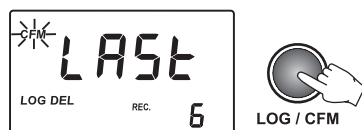

- After the record is deleted, the instrument goes immediately to the first panel of the previous record. If the log becomes empty, "----" will be displayed for one second and the instrument will return to measurement mode.



DELETE ALL RECORDS

To delete all records, scroll through the log until delete all records panel is displayed.

- To delete all records press SETUP/DEL when the "Delete all records" panel is displayed.



DELETE CALIBRATION

HI 83749 is factory calibrated. It is possible to restore factory calibration by deleting last performed calibration.

To delete last calibration, follow the next steps:

- Enter the GLP feature by pressing GLP ▲.
The date of the last calibration will be displayed on the LCD (e.g. 2005.02.23).
- Press READ ► to scroll through the information related to calibration. The last panel is the one with "Delete Calibration".
- Press SETUP/DEL to delete the current calibration. After deletion the instrument will automatically return to measurement mode and the factory calibration is restored.

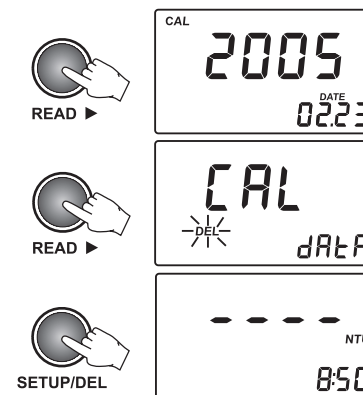

TURBIDITY MEASUREMENT

Note: For wine analysis it is recommended to work always with the AVG mode on.

- Turn the instrument ON by pressing ON/OFF.



ON / OFF

- When the LCD displays “----”, the instrument is ready. The current time appears on the secondary LCD, if selected in Setup menu.

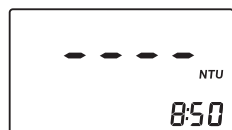

- Fill a clean, dry cuvet with 10 mL of wine up to the mark, taking care to handle the cuvet by the top. Replace the cap.

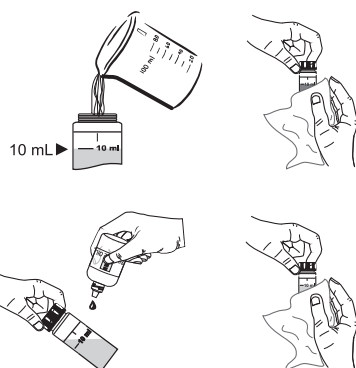

Note: To remove any fingerprints or dirt, wipe the cuvet thoroughly with a lint-free cloth. If necessary, apply HI 93703-58 Silicone Oil (see General Tips for an accurate measurements, page 10), recommended only if low turbidity values need to be read.

- Place the cuvet into the instrument and close the lid.

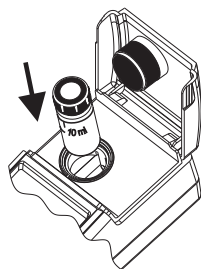

- Press READ ► and “----” will blink on the display.

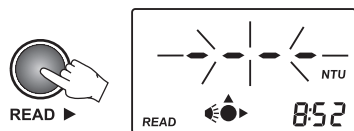

- At the end of the measurement, the instrument directly displays turbidity in NTU.

VIEW LOGGED DATA

The stored records can be viewed at any moment by keep CAL/RCL key pressed for a few seconds. To return to normal measurement mode, press RCL again .



CAL/RCL

LOG SEARCHING

The log records are stored in chronological order. The first displayed record is the last stored one.

- Press UP or DOWN keys to scroll the log memory record by record. By keeping pressed the UP or DOWN keys, the scrolling speed will increase. The scrolling of the log is possible from any panel of the record, except “Delete last log” and “Delete all logs” panels.
- When scrolling the log, the number of the record is displayed for one second on the secondary LCD together with “TAG” if the identification of the sampling location was made.

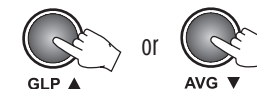

GLP ▲

AVG ▼

When the end of the log is reached, an error beep is heard.

RECORD VIEWING

Each record contains more information than the measured value. The additional information is grouped in several panels.

Press READ ► to scroll through the record panels. The record panels are displayed one by one in a circular way.

Each record contains the following panels:

- The record value (turbidity value) and record number.

Note: If the logged sample value is an over range reading, the maximum value (1200) will be displayed blinking.

- The hexadecimal string of the tag for the sampling location ID.

Note: If the ID data are missing, “----” is displayed instead.



READ ►

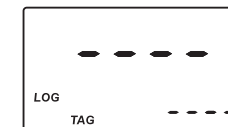

LOGGING

HI 83749 has a log space for up to 200 records. With each measurement, the date, time and tag ID is stored. In this way, each record is fully characterized and can be easily analyzed when downloading data on the PC application (HI 92000).

LOGGING

The log function is active after a valid measurement is obtained (no errors).

- To log a value, press LOG/CFM when the measurement result is displayed. The instrument asks to READ TAG for identification of the sampling location. The location for the new record is also displayed on the secondary LCD.
- To read the ID code for the sampling location identification, simply touch the iButton® tag with the matching connector, located on the back of the instrument (see Connectors Description, page 9). Alternatively, press again LOG/CFM to store the record without the tag ID code.
- If the tag is successfully read, the instrument will beep once, displaying the unique hexadecimal code of the tag, and store the data.

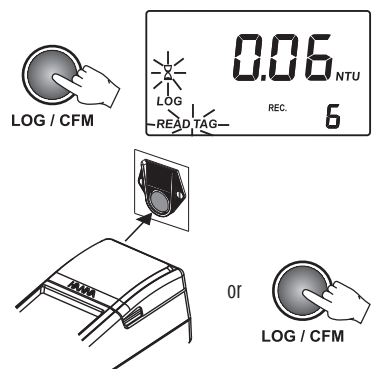

After data is stored, the instrument returns to measurement mode.

- Notes:**
- If the tag is not read within 20 seconds, the logging procedure is canceled.
 - A measurement can be stored only once. Also an over range value can be stored.
 - If less than ten free records are available, the "LOG" tag will blink while storing data.
 - If the log memory is full, the "LoG FULL" message will appear for a few seconds on the LCD and the instrument will return to measurement mode without storing the new record.

To store a new record, delete one or more records.

AVG (SIGNAL AVERAGE MODE)

It is recommended to select this measurement mode when you work with unstable samples that contain suspended particles of different dimensions. In the AVG mode the instrument takes 20 measurements in a short period of time and displays the updated averaged value.

- To select the averaged measurement mode press the AVG ▼ key and the AVG icon will appear on the LCD.

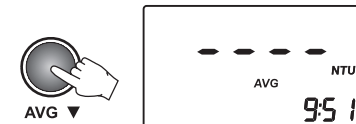

Note: to return to the normal measurement mode just press again the AVG ▼ key.

- Press READ ► and "----" will blink on the display. After a few seconds the instrument displays the first reading. The meter continues updating the readings until the "Lamp and Read Status" indicator turns off. The final displayed value is the averaged reading of turbidity in NTU.

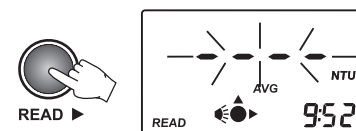

CONTINUOUS MEASUREMENT

This measurement mode can be used to verify how fast suspended parts settle out. Please verify first that the AVG mode is turned off (see instructions above). To make continuous measurement keep the READ ► key pressed until the desired number of measurements are taken. The last value remains on the display after the READ ► key is released.

BENTOCHECK (PROTEIN STABILITY TEST)

- Turn the instrument ON by pressing ON/OFF. When the LCD displays "----", the instrument is ready.

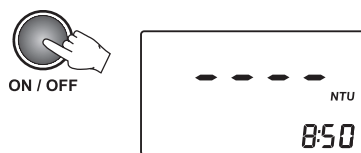

Note: On the secondary LCD the current time appears, if selected in Setup menu.

- Select the AVG mode by pressing the AVG ▼ key. The AVG icon will appear on the display.

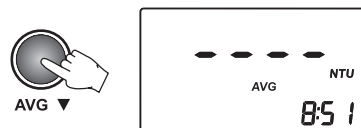

- Fill a clean, dry cuvet with 10 mL of wine up to the mark, taking care to handle the cuvet by the top. Replace the cap and wipe the cuvet thoroughly with a lint-free cloth (see General Tips for an accurate measurements, page 10).

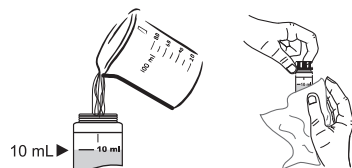

- Place the cuvet into the instrument and close the lid.

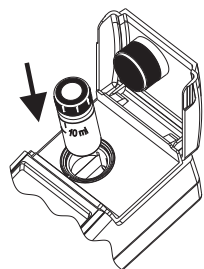

- Press READ ► and "----" will blink on the display. After a few seconds the instrument displays the first reading. The meter continues updating the readings until the "Lamp and Read Status" indicator turns off. The final displayed value is the averaged reading.

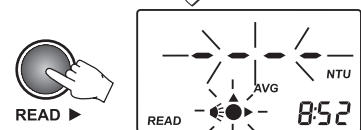

- At the end of the measurement, the instrument directly displays turbidity in NTU. This is **T1**. Record the value.

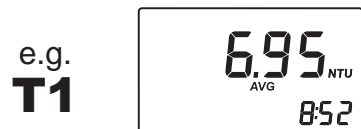

- Use the 1000 µL automatic pipette to add exactly 1 mL of HI 83749-0 Benticheck reagent to the cuvet. For a correct use of the automatic pipette please follow the related Instruction Sheet.

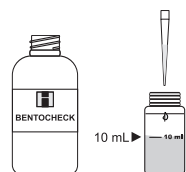

- The final displayed value is the averaged reading of turbidity in NTU. This is **T2**. Record the value.

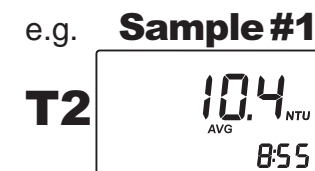

- Repeat the reading procedure for all samples (#2, #3, #4) and record all T1 and T2 values.

- For each sample verify if " $T2 < T1 + 2$ ": if so, the wine can be considered stabilized. Compare the results. It is recommended to choose the lowest dosage of bentonite necessary to stabilize the wine.

- To define the g/hL of bentonite to be added to the wine tank, just multiply by 100 the mL of 2,5% bentonite suspension that was added to the HANNA vial (0.25 mL for vial #1, 0.50 mL for #2, 0.75 mL for #3 and 1.00 mL for #4):

$$\text{Bentonite requirement in g/hL} = \text{mL of bentonite added with syringe} \times 100$$

For example:

	#1 (0.25 mL)	#2 (0.50 mL)	#3 (0.75 mL)	#4 (1.00 mL)
T1	6.95	6.05	5.62	5.10
T2	10.4	8.60	7.50	6.40
T2 < T1 + 2	no	no	yes	yes

For this example, 0.75 mL is the lowest bentonite dosage necessary to stabilize the wine sample. Now just multiply the mL for 100 ($0.75 \times 100 = 75$ g/hL) to obtain the bentonite requirement.

COMPARATIVE MODE

An alternative mode of measurement is Comparative Mode. It is possible to set a reference value (T1) and let the instrument automatically compare turbidity values. See SETUP section, page 29-30.

- Place the cuvet #1 into the instrument and close the lid.

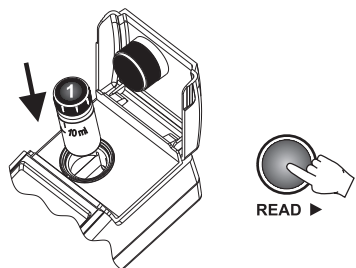

- Press READ ► and “----” will blink on the display. After a few seconds the instrument displays the first reading. The meter continues updating the readings until the “Lamp and Read Status” indicator turns off.

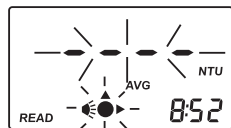

e.g. **Sample #1**



- The final displayed value is the averaged reading. This is **T1** for **sample #1**. Record the value.

- Remove cuvet #1 from the instrument and open the cap.

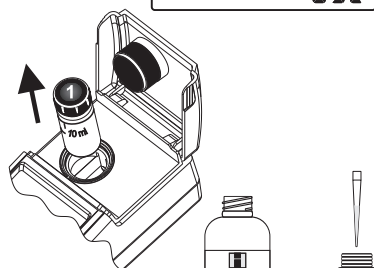

- Use the 1000 μ L automatic pipette to add exactly 1 mL of **HI 83749-0 Bencotcheck** reagent to the cuvet. For a correct use of the automatic pipette please follow the related Instruction Sheet.

- Replace the cap. Invert several times to mix and then wait for 1 minute.

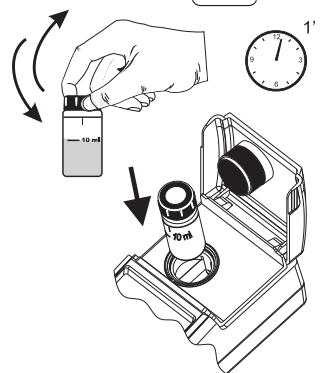

- Insert the cuvet into the instrument and close the lid.

- Press READ ► and “----” will blink on the display. After a few seconds the instrument displays the first reading. The meter continues updating the readings until the “Lamp and Read Status” indicator turns off.

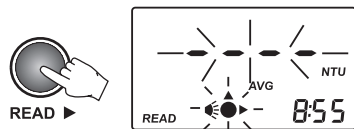

- Replace the cap. Invert several times to mix and then wait for 1 minute.

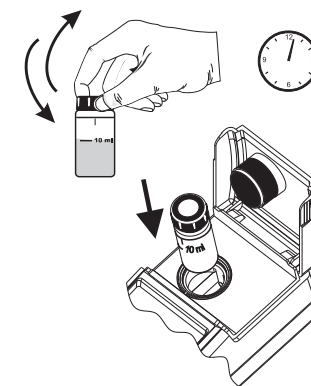

- Insert the cuvet into the instrument and close the lid.

- Press READ ► and “----” will blink on the display. After a few seconds the instrument displays the first reading. The meter continues updating the readings until the “Lamp and Read Status” indicator turns off.

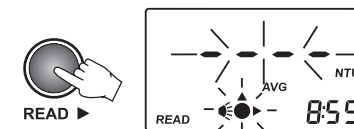

- The final displayed value is the averaged reading of turbidity in NTU. This is **T2**. Record the value.

e.g. **T2**



- If “ $T2 < T1 + 2$ ” the wine can be considered stable. Otherwise the wine needs to be stabilized.

Note: to get more representative results of long term protein stability, HANNA Instruments® recommends to filter the wine sample first through a 0.45 micron filterdisc before analysis.

DETERMINATION OF BENTONITE REQUIREMENT

SAMPLE PREPARATION

- Fill 4 HANNA vials with 25 mL of unfiltered wine sample.
- Prepare a bentonite suspension of 2.5%.
Note: use always a bentonite suspension with the same wetting degree as the suspension that is used in production.

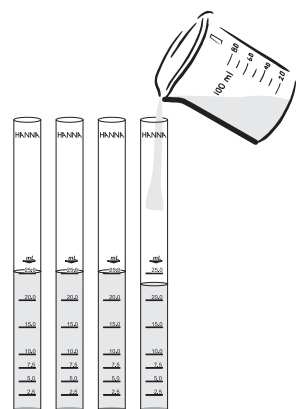

- Use the 1 mL syringe to add 0.25 mL of bentonite suspension to the vial #1; then add 0.50 mL to #2, 0.75 mL to #3 and 1 mL to #4.

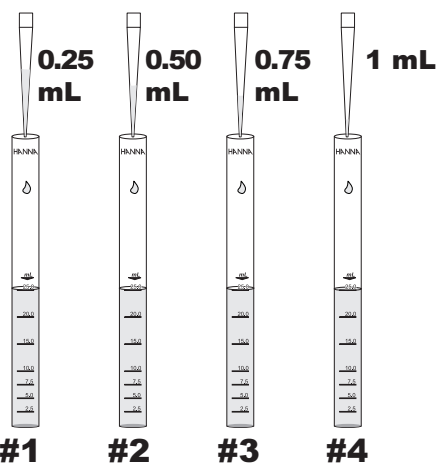

- Note:** in order to measure the exact volume of bentonite suspension with the syringe, follow the instructions on page 11.

- Close the glass vials tightly with their caps and mix thoroughly.

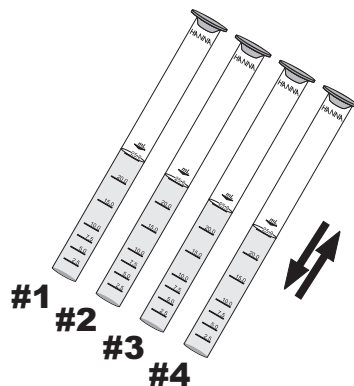

- Wait for 15 minutes to allow suspended matter to settle.



- Fold a filter disc twice as shown in the figure.

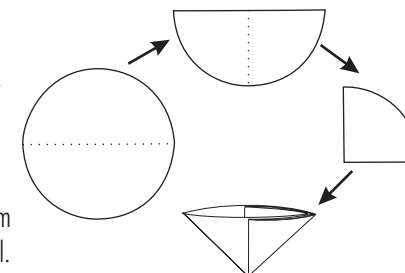

- Separate one side from the other three to form a cone. Insert the folded filter disc in the funnel.

- Decant off clear liquid and filter the treated wine from vial #1 into cuvet #1 to collect 10 mL of filtered sample. Place the cap #1 and wipe the cuvet thoroughly with a lint-free cloth (see General Tips for an accurate measurements, page 10).

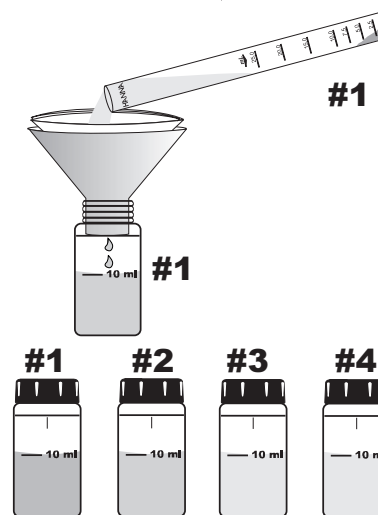

- Prepare fresh filters and repeat the filtration for all treated wine samples (#2, #3, #4).

READING PROCEDURE

- Turn the instrument ON by pressing ON/OFF. When the LCD displays "----", the instrument is ready.

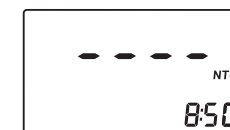

- Select the AVG mode by pressing the AVG ▼ key. The AVG icon will appear on the display.

