

# Instruction Manual

---

## HI 96803 Refractometer for Glucose Measurements

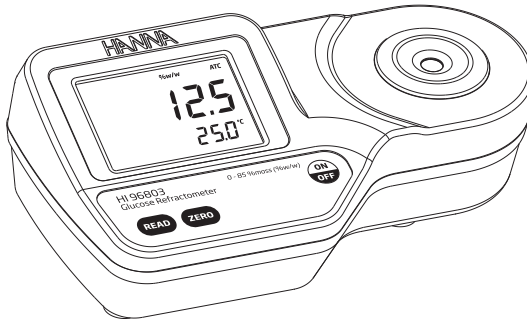

[www.hannainst.com](http://www.hannainst.com)

Dear Customer,  
Thank you for choosing a Hanna Instruments product.  
Please read this instruction manual carefully before using this instrument.  
This manual will provide you with the necessary information for correct use of this instrument, as well as a precise idea of its versatility.  
If you need additional technical information, do not hesitate to e-mail us at [tech@hannainst.com](mailto:tech@hannainst.com) or view our worldwide contact list at [www.hannainst.com](http://www.hannainst.com).

## TABLE OF CONTENTS

---

PRELIMINARY EXAMINATION .....	2
GENERAL DESCRIPTION .....	3
SPECIFICATIONS .....	3
PRINCIPLE OF OPERATION .....	4
FUNCTIONAL DESCRIPTION .....	5
DISPLAY ELEMENTS .....	6
MEASUREMENT GUIDELINES .....	6
CALIBRATION PROCEDURE .....	7
MEASUREMENT PROCEDURE .....	8
MAKING A STANDARD % GLUCOSE SOLUTION .....	9
TO CHANGE TEMPERATURE UNIT .....	9
BATTERY REPLACEMENT .....	10
WARRANTY .....	10
ERROR MESSAGES .....	11

## PRELIMINARY EXAMINATION

---

Remove the instrument from the packing materials and examine carefully to ensure no damage has occurred during shipping. If any damage has occurred, notify your Dealer or closest Hanna Customer Service Center.

Each HI 96803 instrument is supplied with:

- 9 V battery
- Instruction manual

**Note:** Save all packing material until you are sure that the instrument functions correctly. A defective instrument must be returned in its original packing.

*All rights are reserved. Reproduction in whole or in part is prohibited without the written consent of the copyright owner, Hanna Instruments Inc., Woonsocket, Rhode Island, 02895, USA.*

## GENERAL DESCRIPTION

---

The **HI 96803** Digital Glucose Refractometer is a rugged portable, water resistant device that benefits from Hanna's years of experience as a manufacturer of analytical instruments.

The **HI 96803** Digital Glucose Refractometer is a rugged portable, water resistant device that benefits from Hanna's years of experience as a manufacturer of analytical instruments.

The **HI 96803** is an optical instrument that employs the measurement of refractive index to determine the % Glucose in aqueous solutions. The method is both simple and quick. Samples are measured after a simple user calibration with deionized or distilled water. Within seconds the instrument measures the refractive index of the sample and converts it to % by weight concentration units. The **HI 96803** digital refractometer eliminates the uncertainty associated with mechanical refractometers and is easily portable for measurements on the go.

The measurement technique and temperature compensation employ methodology recommended in the ICUMSA Methods Book (Internationally recognized body for Sugar Analysis). Temperature (in °C or °F) is displayed simultaneously with the measurement on the large dual level display along with icons for Low Power and other helpful message codes.

Key features include:

- Dual-level LCD
- Automatic Temperature Compensation (ATC)
- Easy setup and storage
- Battery operation with Low Power indicator (BEPS)
- Automatically turns off after 3 minutes of non-use.

## SPECIFICATIONS

---

Range:	0 to 85 % / 0 to 80 °C (32 to 176 °F)
Resolution:	0.1 % / 0.1 °C (0.1 °F)
Accuracy:	± 0.2 % / ± 0.3 °C (± 0.5 °F)
Temperature Compensation:	Automatic between 10 and 40 °C (50 - 104 °F)
Measurement Time:	Approximately 1.5 seconds
Minimum Sample Volume:	100 µL (cover prism totally)
Light Source:	Yellow LED
Sample Cell:	SS ring and flint glass prism
Case Material:	ABS
Enclosure Rating:	IP 65
Battery Type / Life:	1 X 9V / 5000 readings
Auto-Off:	After 3 minutes of non-use
Dimensions:	19.2(W) x 10.2(D) x 6.7 (H)cm
Mass:	420g

## PRINCIPLE OF OPERATION

The Glucose determination is made by measuring the refractive index of a solution. Refractive Index is an optical characteristic of a substance and the number of dissolved particles in it. Refractive Index is defined as the ratio of the speed of light in empty space to the speed of light in the substance. A result of this property is that light will “bend”, or change direction, when it travels through a substance of different refractive index. This is called refraction.

When passing from a material with a higher to lower refractive index, there is a critical angle at which an incoming beam of light can no longer refract, but will instead be reflected off the interface. The critical angle can be used to easily calculate the refractive index according to the equation:

$$\sin(\theta_{\text{critical}}) = n_2 / n_1$$

Where  $n_2$  is the refractive index of the lower-density medium;  $n_1$  is the refractive index of the higher-density medium.

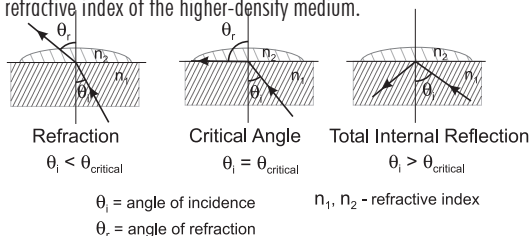

In the **HI 96803**, light from an LED passes through a prism in contact with the sample. An image sensor determines the critical angle at which the light is no longer refracted through the sample. The **HI 96803** automatically applies temperature compensation to the measurement and converts the refractive index of the sample to Glucose concentration in units of percent (by weight).

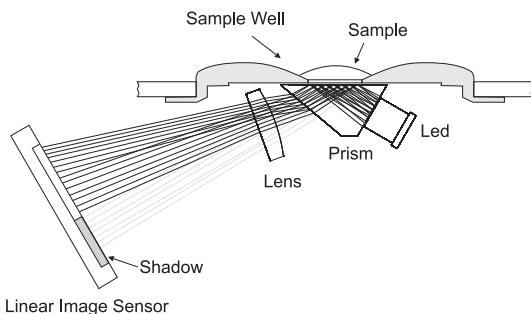

## FUNCTIONAL DESCRIPTION

---

### TOP VIEW

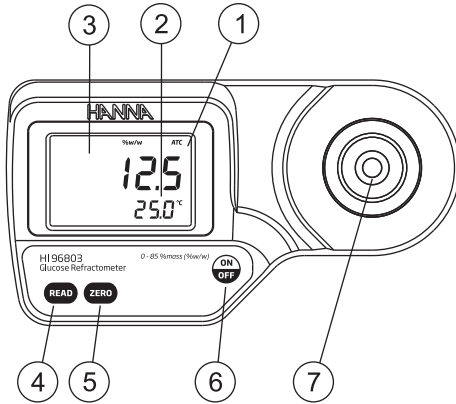

1. Liquid Crystal Display (LCD)
2. Secondary Display
3. Primary Display
4. **READ** Key (User Measurement)
5. **ZERO** Key (User Calibration)
6. **ON/OFF**
7. Stainless Steel Sample Well and Prism

### BOTTOM

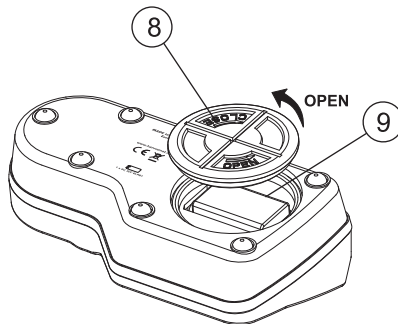

8. Battery Cover
9. Battery Compartment

## DISPLAY ELEMENTS

---

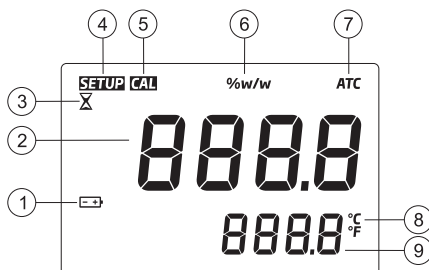

1. Battery (blinks when low battery condition detected)
2. Primary Display (displays measurement and error messages)
3. Measurement in Progress Tag
4. SETUP: Factory Calibration Tag
5. CAL: Calibration Tag
6. Measurement Unit
7. Automatic Temperature Compensation  
(blinks when temperature exceeds 10-40 °C / 50-104 °F range)
8. Temperature Units
9. Secondary Display (displays temperature measurements; when blinking, temperature has exceeded operation range: 0-80 °C / 32-176 °F)

## MEASUREMENT GUIDELINES

---

- Handle instrument carefully. Do not drop.
- Do not immerse instrument under water.
- Do not spray water to any part of instrument except the "sample well" located over the prism.
- The instrument is intended to measure Glucose solutions. Do not expose instrument or prism to solvents that will damage it. This includes most organic solvents and extremely hot or cold solutions.
- Particulate matter in a sample may scratch the prism. Absorb sample with a soft tissue and rinse sample well with deionized or distilled water between samples.
- Use plastic pipettes to transfer all solutions. Do not use metallic tools such as needles, spoons or tweezers as these will scratch the prism.
- To reduce the effects of evaporation or absorption of water when taking readings over a period of time, the prism and sample well can be covered with plastic wrap.

## CALIBRATION PROCEDURE

Calibration should be performed daily, before measurements are made, when the battery has been replaced, between a long series of measurements, or if environmental changes have occurred since the last calibration.

1. Press the **ON/OFF** key, then release. Two instrument test screens will be displayed briefly; all LCD segments followed by the percentage of remaining battery life. When LCD displays dashes, the instrument is ready.



2. Using a plastic pipette, fill the sample well with distilled or deionized water. Make sure the prism is completely covered.

**Note:** If the ZERO sample is subject to intense light such as sunlight or another strong source, cover the sample well with your hand or other shade during the calibration.



3. Press the **ZERO** key. If no error messages appear, your unit is calibrated. (For a description of ERROR MESSAGES see page 11).

**Note:** The 0.0 screen will remain until a sample is measured or the power is turned off.

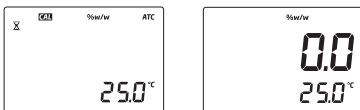

4. Gently absorb the ZERO water standard with a soft tissue. Use care not to scratch the prism surface. Dry the surface completely. The instrument is ready for sample measurement.

**Note:** If the instrument is turned off the calibration will not be lost.



## MEASUREMENT PROCEDURE

Verify the instrument has been calibrated before taking measurements.

1. Wipe off prism surface located at the bottom of the sample well. Make sure the prism and sample well are completely dry.



2. Using a plastic pipette, drip sample onto the prism surface. Fill the well completely.

**Note:** If the temperature of the sample differs significantly from the temperature of the instrument, wait approximately 1 minute to allow thermal equilibration.



3. Press the **READ** key. The result is displayed in units of % by weight (w/w).

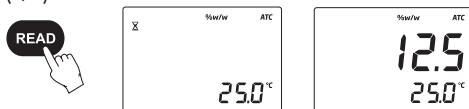

**Note:** The last measurement value will be displayed until the next sample is measured or the instrument is turned off. Temperature will be continuously updated.

**Note:** The **ATC** tag blinks and automatic temperature compensation is disabled if the temperature exceeds the 10-40 °C / 50-104 °F range.

4. Remove sample from the sample well by absorbing with a soft tissue.
5. Using a plastic pipette, rinse prism and sample well with distilled or deionized water. Wipe dry. The instrument is ready for the next sample.





## MAKING A STANDARD % GLUCOSE SOLUTION

To make a Glucose Solution, follow the procedure below:

- Place container (such as a glass vial or dropper bottle that has a cover) on an analytical balance.
- Tare the balance.
- To make an X Glucose solution weigh out X grams of high purity Glucose (CAS #: 50-99-7) directly into the container.
- Add distilled or deionized water to the container so the total weight of the solution is 100g.
- **Note:** Solutions above 20 % may need to be vigorously stirred or shaken and heated in a water bath. Remove solution when glucose has dissolved. Cool completely before use.

Example with 25%:

<u>%</u>	<u>g Glucose</u>	<u>g Water</u>	<u>g Total</u>
25	25.000	75.000	100.000

## TO CHANGE TEMPERATURE UNIT

To change the temperature measurement unit from Celsius to Fahrenheit (or vice versa), follow this procedure.

1. Press and hold the **ON/OFF** key continuously for approximately 8 seconds. The LCD will display the “all segment” screen followed by a screen with the model number on the primary display and the version number on the secondary display. Continue pressing the **ON/OFF** key.

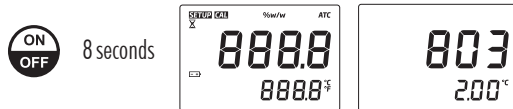

2. While continuing to hold the **ON/OFF** key, press the **ZERO** key. The temperature unit will change from °C to °F or vice versa.

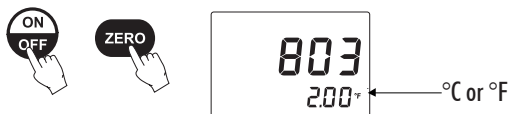

## BATTERY REPLACEMENT

---

To replace the instrument's battery, follow these steps:

- Make sure the instrument is off.
- Turn instrument upside down and remove the battery cover by turning it counterclockwise.

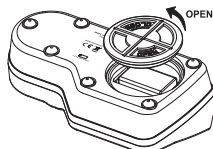

- Extract the battery from its location.
- Replace with new 9V battery making certain to observe polarity.
- Insert the back battery cover and fasten it by turning clockwise to engage.

## WARRANTY

---

HI 96803 is guaranteed for two years against defects in workmanship and materials when used for their intended purpose and maintained according to instructions.







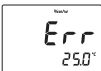

This warranty is limited to repair or replacement free of charge.

Damage due to accidents, misuse, tampering or lack of prescribed maintenance is not covered.

If service is required, contact the dealer from whom you purchased the instrument. If under warranty, report the model number, date of purchase, serial number and the nature of the problem. If the repair is not covered by the warranty, you will be notified of the charges incurred. If the instrument is to be returned to Hanna Instruments, first obtain a Returned Goods Authorization number from the Technical Service department and then send it with shipping costs prepaid. When shipping any instrument, make sure it is properly packed for complete protection.

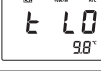
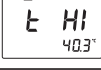
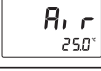
To validate your warranty, fill out and return the enclosed warranty card within 14 days from the date of purchase.

## ERROR MESSAGES

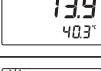
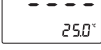
Error Code		Description
"Err"		General failure. Cycle power to instrument. If error persists, contact Hanna.
"LO" primary display		Sample exceeds minimum measurement range.
"HI" primary display		Sample exceeds maximum measurement range.
"LO" primary display Cal segment ON		Wrong solution used to zero instrument. Use deionized or distilled water. Press ZERO.
"HI" primary display Cal segment ON		Wrong solution used to zero instrument. Use deionized or distilled water. Press ZERO.
"t LO" primary display Cal segment ON		Temperature exceeds ATC low limit (10.0 °C) during calibration.
"t HI" primary display Cal segment ON		Temperature exceeds ATC high limit (40.0 °C) during calibration.
"Air"		Prism surface insufficiently covered.
"ELt"		Too much external light for measurement. Cover sample well with hand.
"nLt"		LED light is not detected. Contact Hanna.
Battery segment blinking		<5% of battery life is remaining.
Temperature values are blinking "0.0 °C" or "80.0 °C"		Temperature measurement out of range (0.0 to 80.0 °C).
ATC segment blinking		Outside temperature compensation range (10.0 to 40.0 °C).
SETUP segment blinking		Factory calibration lost. Contact Hanna.



**Hanna Instruments Inc.**  
Highland Industrial Park  
584 Park East Drive  
Woonsocket, RI 02895 USA

**Technical Support for Customers**

Tel. (800) 426 6287  
Fax (401) 765 7575  
E-mail [tech@hannainst.com](mailto:tech@hannainst.com)  
[www.hannainst.com](http://www.hannainst.com)

**Local Sales and Customer Service Office**

