

HI6221

pH and ORP Benchtop Meter



INSTRUCTION MANUAL

Dear
Customer,

Thank you for choosing a Hanna Instruments product.

Please read this instruction manual carefully before using this instrument.

This manual will provide you with the necessary information for correct use of this instrument, as well as a precise idea of its versatility.

If you need additional technical information, do not hesitate to e-mail us at tech@hannainst.com or view our contact list at www.hannainst.com.

All rights are reserved. Reproduction in whole or in part is prohibited without the written consent of the copyright owner, Hanna Instruments Inc., Woonsocket, Rhode Island, 02895, USA.

TABLE OF CONTENTS

- 1. Preliminary Examination 5
- 2. Safety Measures 6
- 3. Abbreviations 6
- 4. User Interface — Icons 7
- 5. General Description & Intended Use 9
 - 5.1. Main Features 10
- 6. Specifications 11
 - 6.1. Instrument 11
 - 6.2. Electrodes 14
- 7. Functional & LCD Description 15
 - 7.1. Main Unit 15
 - 7.2. Electrodes 17
- 8. Getting Started 18
 - 8.1. Attaching the HI764060 Electrode Holder 18
 - 8.2. Using the Electrode Holder 20
 - 8.3. Connecting Electrodes & Keyboard 20
 - 8.4. Powering the Unit 21
 - 8.5. Basic Operations 22
- 9. System Menu Items 23
 - 9.1. Users 24
 - 9.2. Settings 28
 - 9.3. Log recall 34
 - 9.4. Help 40
- 10. Measurement & Electrode Setup Menu 41
 - 10.1. Reading 44
 - 10.2. Temperature 45
 - 10.3. Calibration 46
 - 10.4. View 48
 - 10.5. Alarm 51

10.6. Logging 52

10.7. Profiles 53

11. Calibration 55

 11.1. pH Calibration 56

 11.2. Relative mV Calibration 60

12. Measurement 63

 12.1. Measurement Tips 63

 12.2. Direct Readings 63

 12.3. Direct / Autohold Readings 64

13. Error Messages 65

14. Logging 66

 14.1. Automatic Logging 66

 14.2. Manual Logging 67

 14.3. Autohold Logging 68

15. Maintenance & Conditioning 70

16. Accessories 72

Certification 79

Recommendations for Users 79

Warranty 79

Regulatory notices for the Wi-Fi module 80

1. PRELIMINARY EXAMINATION

Each HI6221 pH and ORP benchtop meter is supplied with:

- HI1131B pH electrode
- HI7662-TW temperature probe
- pH calibration starter kit consisting of:
 - pH 4.01 buffer solution sachet (2 pcs.)
 - pH 7.01 buffer solution sachet (4 pcs.)
 - pH 10.01 buffer solution sachet (2 pcs.)
- HI700601 electrode cleaning solution sachet (2 pcs.)
- HI7082 3.5M KCl electrolyte solution (30 mL)
- HI764060 electrode holder
- Capillary pipette
- 24 VDC power adapter
- USB-C to USB-A cable
- Instrument quality certificate
- Probe quality certificate
- Instruction manual

Note: Save all packing material until you are sure the instrument works correctly. Any damaged or defective item must be returned in its original packing material with the supplied accessories.

2. SAFETY MEASURES

Handling precautions

The unit, while not fragile, can be damaged by improper usage and handling.

- Do not puncture or drop the unit.
- Keep the unit on a stable and even surface, away from contact with liquid.
- When carried, ensure the unit is held securely and not via an accessory, cable, or cord.

Usage precautions

- Do not use the device near heat sources, food, excessive dirt, dust, oil, chemicals, or in strong direct sunlight.
- Do not place objects on top of the device.
- Do not insert objects into the ports, spaces around keys, or other openings.
- If the device becomes wet, gently wipe the exterior with a clean, dry cloth.
- Use only attachments and accessories specified in this manual.

Touch screen recommendations

- Avoid damaging the touch screen with pointed or sharp objects.
- Only operate the LCD touch screen by gentle finger tapping.

Device sharing

- Make sure that all users understand the safety and usage information provided in this manual.



Environment recommendations





















- Use only in a safe place that is appropriate to application requirements.









3. ABBREVIATIONS

















ATC	Automatic Temperature Compensation
CSV	Comma-Separated Values
FTP	File Transfer Protocol
GLP	Good Laboratory Practice
HT	High Temperature
MTC	Manual Temperature Compensation
NIST	National Institute of Standards and Technology

4. USER INTERFACE – ICONS

Capacitive keys	Description
	Home key
	Back key
	Menu key

Symbol on display	Description
	Measurement Menu
	Available log storage
	Log Recall
	System Menu
	Users
	Help
	Start logging
	Stop logging
	Manual logging
	pH / ORP electrodes
	Log recall, modify settings
	Log recall, graph view - function not selected
	Log recall, graph view - function active
	Log recall, table view - function not selected
	Log recall, table view - function active
	Log recall, information view - function not selected
	Log recall, information view - function active
	Annotated text
	Annotated text (in use)
	Warning on standby function
	Warning on active function

Symbol on display	Description
	Autohold applied
	Autohold, waiting stable pH measurement
	Autohold, waiting stable mV measurement
	Triggers log session, pending next stable measurement
	Autohold logging in progress
	Forward/backward navigation, sequence of steps - function not available
	Active buffer selection during manual or semiautomatic calibration
	Calibration procedure, buffer selection - function available
	Calibration procedure, buffer selection - function not available

Connection established Icon on display	Description	Connection status		
		In progress	Connection issue	Hardware error
	Ethernet			
	Wi-Fi			
	USB-A and USB-C			
	PC			

5. GENERAL DESCRIPTION & INTENDED USE

HI6221 is a streamlined benchtop meter with a large touch screen display, comprised of a housing and an integrated pH / ORP measurement module.

Compact and easy to operate, the benchtop meter is delivered with Hanna Instruments HI1131B double junction combination pH electrode, together with HI7662-TW temperature probe.

HI1131B is a glass body, double junction, refillable pH electrode with an indicating sensor made of High Temperature (HT) glass. The double junction reference and HT glass design allow the HI1131B to be used in a wide variety of applications including samples with metals and elevated temperatures. Probe connection to the unit is secured through a galvanically isolated BNC connection.

HI7662-TW stainless steel temperature probe allows the meter to automatically temperature compensate (ATC) pH measurements.

This system responds to a complex range of measurement and monitoring requirements, providing accuracy, reproducibility, and reliability.

HI6221 is supplied with an electrode holder that has a flexible arm. The holder can be mounted quickly and provides secure support for electrodes while taking measurements in sample containers.

This benchtop meter supports:

- USB type A – support for USB stick, keyboard
- USB type C – support for USB stick, PC connection

The user can select between five different views.

- Basic measurement configuration
- Simple GLP with calibration information
- Full GLP with electrode status and calibration point details
- Live updated, interactive graph
- Tabuled data with date, time, and notes

Capacitive touch screen with multi-touch support

The benchtop unit has a 7-inch color display with 800 x 480p resolution. The capacitive, multi-touch screen supports video playback and data plotting.

Capacitive keys & icons

Main functions, system settings, and measurement setup parameters are accessed and configured in an intuitive way, using **Menu** key (≡), System Menu icon (⚙), and Measurement Menu icon (⚙).

User interface

User-friendly icons and symbols allow users to easily navigate and interpret the instrument functions. Using the **Menu** key (≡) will show Users, System Settings, Log Recall and Help icons.

- The System Menu (⚙) permits access to Network, Connectivity, System, and Info tabs.

- The Measurement Setup icon (⚙️), found in measurement screen, opens sensor setup parameters.
- The Log Recall icon (▶️) recalls stored log sessions (Automatic continuous logging, Manual, or Autohold).

5.1. MAIN FEATURES

Measurement & Calibration

- Measure pH/mV (pH) or mV/Rel.mV (ORP) with temperature
- Application-specific profiles allow quick and direct measurement without the need to update the sensor and system settings
- Active log during measurement
- Measurement stability indicator (using the Stability Criteria setting)
- Reading modes: direct and direct/autohold
- Temperature compensation can be Automatic (using temperature probe) or set manually
- Audible and/or alarm messages for measurements outside of predefined limits
- Galvanic isolation for pH/ORP measurement module
- 5-point pH calibration with automatic recognition for standard buffers (Hanna and NIST buffers)
- Choice of standard or custom buffers for calibration
- Non-volatile memory saves data and settings

Logging

- Data log collection of at least 1 000 000 data points (with time and date stamp)
- Logging types: manual, automatic, autohold
- Sample ID for manual and Autohold data

Connectivity features & services

- Transfer logged data to a USB thumb drive
- Log files that include measurements and calibration data (as .csv file)
- FTP and email for log export via Ethernet and Wi-Fi connection

Help section for meter guidance

- Video support presentation of main features

6. SPECIFICATIONS

6.1. INSTRUMENT

Range	pH	-2.0 to 20.0 pH -2.00 to 20.00 pH -2.000 to 20.000 pH
	mV	±2000.0 mV
	Temperature	-20.0 to 120.0 °C -4.0 to 248.0 °F 253.0 to 393.0 K
Resolution	pH	0.1 pH 0.01 pH 0.001 pH
	mV	1 mV 0.1 mV
	Temperature	0.1 °C / 0.1 °F / 0.1 K
Accuracy	pH	±0.1 pH ±0.01 pH ±0.002 pH (±1 last significant digit)
	mV	±0.2 mV ±1 last significant digit
	Temperature	±0.2 °C / ±0.4 °F / ±0.2 K
Relative mV offset range		±2000.0 mV
Reading	Modes	Direct Direct/Autohold
	Stability criteria	Accurate Medium Fast
	Isopotential	7.000 or 4.010
	Sampling rate	1000 ms

pH Calibration	Calibration points	Up to 5
	Type	Automatic Semiautomatic Manual
	Standard buffers	Hanna and NIST pH 1.68, 3.00, 4.01, 6.86, 7.01, 9.18, 10.01, 12.45
	Custom buffers	Up to 5
	Custom group	Up to 5
	1 st calibration point	Offset or Points (user setting)
pH Views	Reminder	Disabled Daily: 0 min. to 23 hours and 59 min. Periodic: 1 min. to 500 days, 23 hours and 59 min.
	Basic	Measurement (pH, mV, Rel.mV, Abs.mV) Temperature, Stability status
	Simple GLP	Basic view information Last calibration date, electrode offset, average slope, and electrode condition
	Full GLP	Simple GLP information and calibration point details
	Table	Measurements updated every second are displayed in table
	Graph (Plot)	pH (or mV) and temperature versus time graph can be panned or zoomed (pinch-to-zoom technology)
Temperature Compensation		Automatic or Manual
Logging	Type	Automatic, Manual, Autohold
	Number of records	50 000 maximum per file Stores at least 1 000 000 data points per user
	Automatic interval	1, 2, 5, 10, 30 seconds 1, 2, 5, 10, 15, 30, 60, 120, 150, 180 minutes
	Sample ID	Incremental mode
	Export option	.csv file format
Users		Up to 9 users and admin. account (default)

Connectivity	USB-A	2 ports for keyboard input or USB thumb drive
	USB-C	1 port for PC connectivity and USB-C type thumb drive
	Wi-Fi & Ethernet	FTP Web server Log transfer and download Email
	RS232	Connecting peripherals
Power supply	DC adapter 100-240AC to 24VDC 2.5A	
Environment	0 - 50 °C / 32 - 122 °F / 273 - 323 K maximum 95% RH non-condensing	
Dimensions	205 x 160 x 77 mm (8.0 x 6.2 x 3.0 ")	
Weight	Approximately 1.2 kg (26.5 lbs.)	

6.2. ELECTRODES

HI1131B — pH electrode

Range	0 to 14 pH
Reference cell type	Double, Ag/AgCl
Junction type	Ceramic Single 15-20 μ L per h
Refill electrolyte	3.5M KCl
Maximum pressure	0.1 bar
Body material	Glass
Tip shape	Spheric (\emptyset 9.5 mm)
Recommended operating temperature	0 to 100°C (32 to 212°F) - HT
Temperature sensor	No
Amplifier	No
Cable	Coaxial; 1 m (3.3')
Recommended use	Laboratory samples, general purpose

HI7662-TW — Temperature probe

Body material	Stainless steel
Connector type	RCA Phono connector
Dimensions	Total length: 100 mm (3.94 ") \emptyset 3 mm (0.12 "), active part
Cable	1 m (3.3') length

7. FUNCTIONAL & LCD DESCRIPTION

7.1. MAIN UNIT

FRONT view

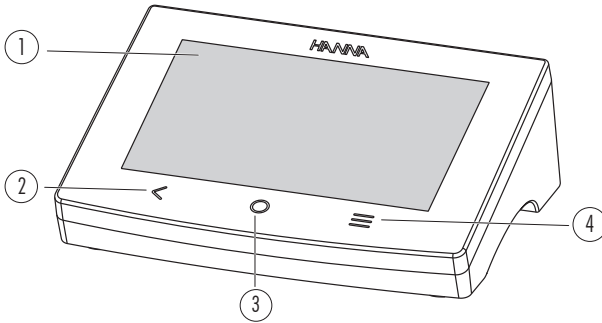

1 LCD display	3 Home key
2 Back key	4 Menu key

LCD description

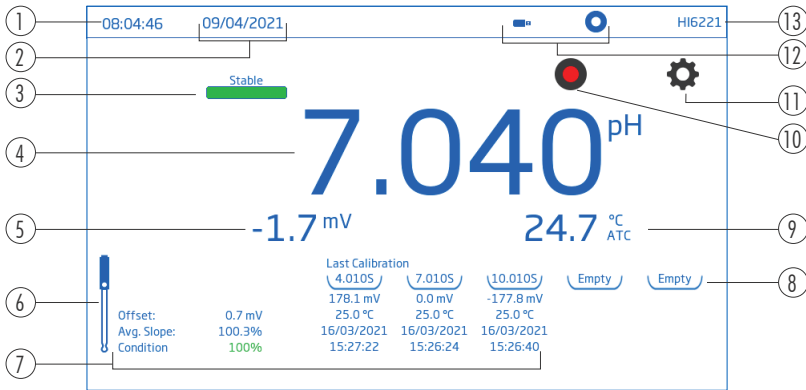

- | | |
|--|---|
| <ol style="list-style-type: none"> 1. Current time 2. Current date 3. Stability indicator 4. pH reading 5. mV reading 6. pH electrode icon | <ol style="list-style-type: none"> 7. Calibration information: Electrode condition, Offset, Slope, Date and Time 8. Buffer trays 9. Temp. reading and Temp. compensation status 10. Start Logging icon 11. Measurement Menu icon 12. USB connection status and Logging space availability 13. User name (default "HI6221") |
|--|---|

Status Area

14:30:13 03/03/2021 192.168.0.39    HI6221

Continuously displayed after powering the unit, status area runs horizontally across the top of the LCD screen and is organized as:

- Current time and date, top left corner
- Connection status, middle
- Username and available log space, top right corner

Capacitive keys

Icon	Name	Function
<	Back key	<ul style="list-style-type: none"> • direct key, returns the user to previous hierarchical menu level • additionally, it also performs an exit or escape function
○	Home key	<ul style="list-style-type: none"> • direct key for measurement screen • performs an exit or escape function
≡	Menu key	<ul style="list-style-type: none"> • direct key for the system's Menu items • permits access to the system's settings, log recall, help, and users configuration

REAR view

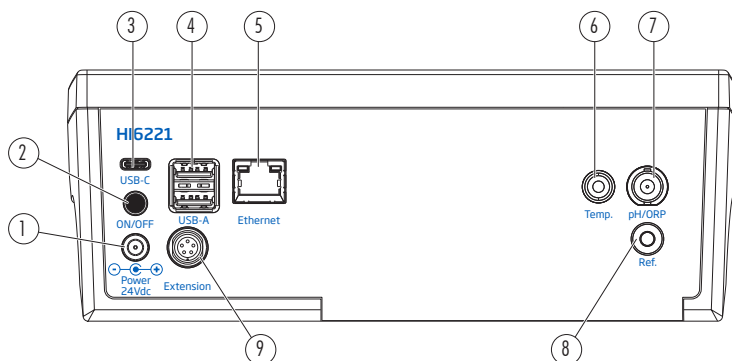

- | | |
|---|--------------------------------------|
| 1. Input for power cable | 6. Temperature probe connection port |
| 2. Power button | 7. pH/ORP probe connection port |
| 3. Input for USB-C flash or PC cable | 8. Reference electrode socket |
| 4. Input for USB-A flash (x2) or keyboard | 9. Peripherals port |
| 5. Ethernet port | |

7.2. ELECTRODES

HI1131B – pH electrode

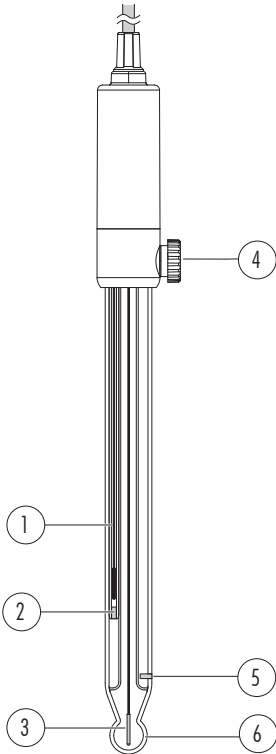

HI7662-TW – Temperature probe

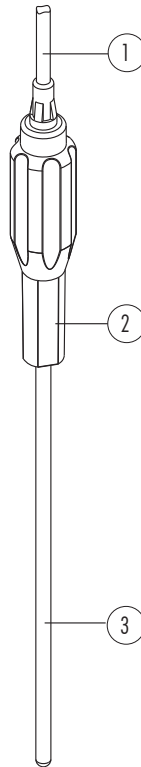

1. Reference wire
2. Inner reference junction
3. Double, Ag/AgCl reference cell type
4. Reference fill cap
5. Outer reference junction
6. Glass bulb

1. Cable
2. Handle
3. Stainless steel tube

8. GETTING STARTED

8.1. ATTACHING THE HI764060 ELECTRODE HOLDER

Attaching the electrode stand and arm

- Take the HI764060 electrode holder from the box.
- Identify the metal base plate (4) with the integrated pivot pin (5) and the screw (2).
- The plate may be attached to either side of the meter, left (L) or right (R).
- Place the meter face down on a clean, dry surface.
- Align the base plate over the rubber foot (6R or 6L) and hole (3) on the meter case. The pivot pin (5) should be facing downward.
- Use a screwdriver (1) to tighten the screw (2) and attach the base plate to the meter.

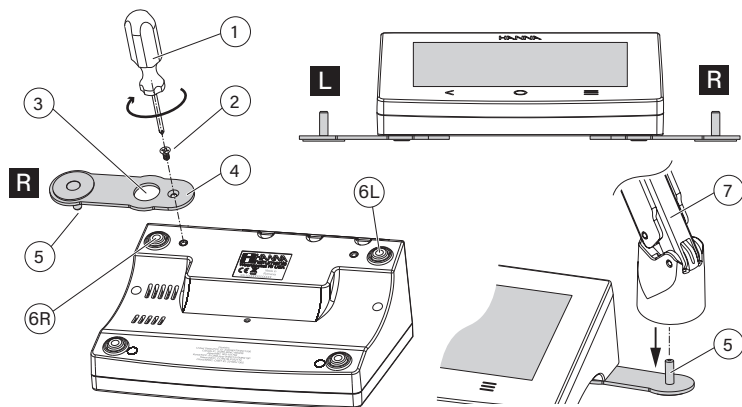

- Position the meter with the display facing up.
- Slide the electrode holder (7) over the pivot pin (5).
- Insert the electrode holder into the metal post in the base plate. Only a “slide in” motion is required to lock the arm into position.
- For increased arm rigidity, tighten the metal knobs on both sides of the electrode holder. The electrode arm has an electrode holder on the end of it.

Attaching the cable holder clip

To secure the cabling, fasten the plastic clip onto the electrode arm by following the steps:

1. Align the clip's dovetail over the slot.
2. Gently push down to slide in position.
3. To close the latch, lower latch over cable and snap closed.

The latch snaps in position and secures the cables inside.

- To open the latch, press the clip inward while pulling up the latch.

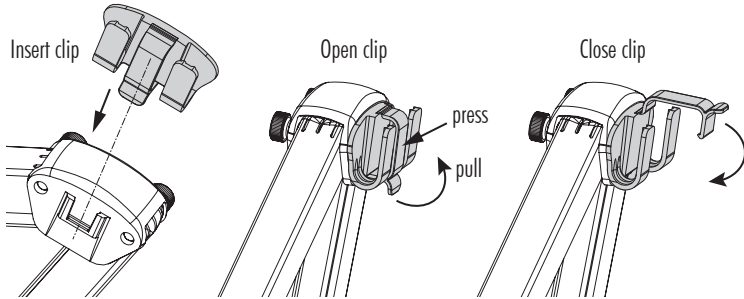

Easy to install and able to accommodate several cables, the clip secures the cabling by allowing cables to move freely with the arm motion.

Using the adapter

The electrode holder at the end of the arm has three different-sized apertures:

- One located center-front (temperature probe only)
- One located center-back (pH probe with adapter only)
- Two located sideways, left and right (pH probe only, no adapter required)

When a center-positioning of the probe is required:

1. Orient the adapter such that the positioning marks align with the positioning marks on the electrode holder.
2. Insert the adapter slowly into the holder keeping the positioning marks on the adapter and electrode holder aligned with each other.
If the adapter appears blocked, it may need to be rotated slightly to correctly engage the guides.
3. Using medium to light pressure, push the adapter down until it securely clicks in place.
4. Insert the electrodes into the openings and clip the cables through the top-entry cable clip.

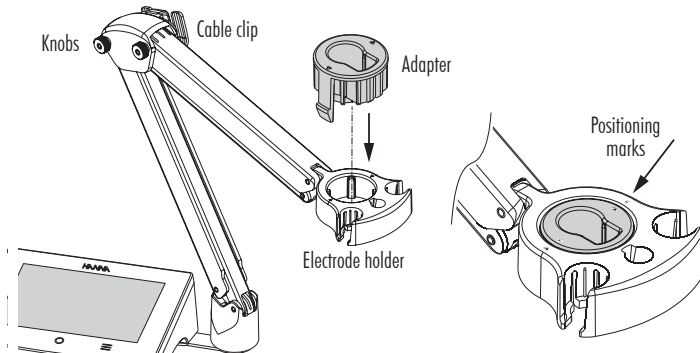

Note: Always take notice of the following precautions when using the adapter:

Users should be able to insert the adapter with light to moderate pressure. Never use excessive force to insert the adapter.

If the adapter is not reaching the bottom, if there is resistance, re-check that the positioning marks are aligned on the adapter and arm holder's head.

8.2. USING THE ELECTRODE HOLDER

Place electrodes in the holder for support and easy movement in and out of beakers and containers. The electrode holder easily positions electrodes during calibration, sample measurement, and storage with protective cap on.

8.3. CONNECTING ELECTRODES & KEYBOARD

Connecting the electrodes

Any analog pH or ORP electrode with BNC connector (non-amplified or non-digital) can be used with the meter. pH or ORP half-cell sensors and separate reference electrode with suitable jack connectors can also be used.

Hanna Instruments pH electrodes with integral temperature elements are also supported.

The [HI1131B](#) glass-bodied combination pH electrode is connected through a BNC connector, which makes attaching and removing the probe an easy process.

When connected, the probe is automatically detected.

With the meter off:

- Connect the probe to the BNC connection port, on the top right of the meter.
- Align the key and twist the plug into the socket.
- Place the probe into the holder and secure the cable in the cable holder clip.
- Power the unit.

The temperature probe, [HI7662-TW](#), is connected to the benchtop unit through an RCA connector.

With the meter off:

- Plug the connector into the socket.

- Place the probe into the holder and secure the cable in the cable holder clip.
- Power the unit.

Note: Connectors and plugs must be connected firmly for the system to work correctly.

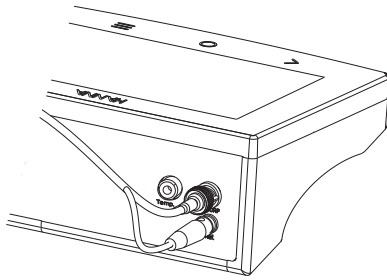

Connecting a USB-A keyboard

Connect a USB's keyboard plug into the USB-A input on the back of the unit. Once connected the keyboard is automatically detected.

8.4. POWERING THE UNIT

After connecting the electrode to the meter:

1. Connect the power adapter to the rear panel of the meter.
2. Connect the power plug into the 24V power socket.
3. Press the black ON/OFF power button located on the back of the meter case, to power the instrument. At start up, the meter briefly displays the initialization screen (the Hanna Instruments logo, meter name, and bootloader version).
4. Next, the instrument launches into a Tutorial. Tap **Skip** to opt out from viewing the Tutorial. The Measurement screen opens up.

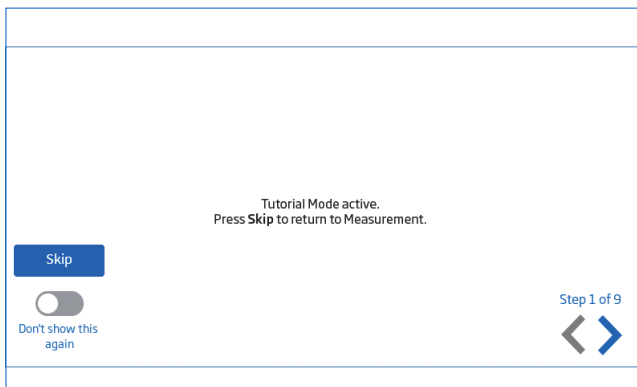

8.5. BASIC OPERATIONS

- The general operating modes are setup, measurement, logging, and data sharing.
- Tap direct **Menu** key (☰) on the unit and tap:
 - Users setup icon (👤) to open user menu.
 - System Menu icon (⚙️) to access meter settings.
 - Log Recall icon (📄) to access log history and manage files.
User can view a single sample or an interval log session, see Logging section for detailed description.
 - Help icon (❓) to access text and video support.
- Tap direct **Home** key (○) on the unit to return to measurement.
- Tap Measurement Menu icon (⚙️) to gain access to sensor-related functions.

When the benchtop meter is powered on for the first time, the default language is English.

Go to System Menu (⚙️) and select System tab to change the operating language as well as date, time, and region settings.

9. SYSTEM MENU ITEMS

Tap direct **Menu** key (☰) on the unit (users must have previously logged in) for the System Menu screen to be displayed.

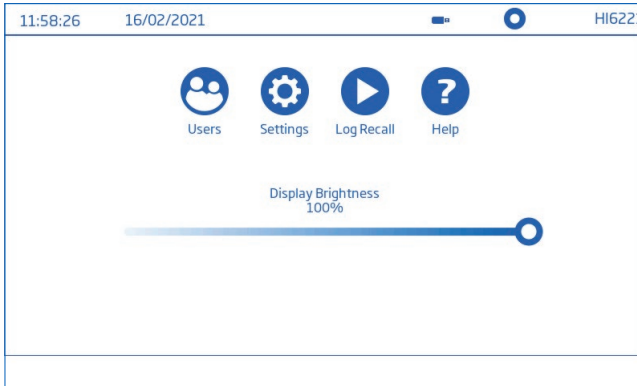

System Menu icons & brightness control bar

Symbol	Name	Functionality
	Users	Tap to login and start configuring rights and instrument accessibility.
	Settings	Tap to start configuring system and connectivity items.
	Log Recall	Tap to access logged measurement data.
	Help	Tap to access video-supported outline of main instrument functionalities.



Display brightness may be adjusted to the desired level by sliding the virtual slider button along the horizontal bar.

9.1. USERS

Users is the first item under the System Menu.

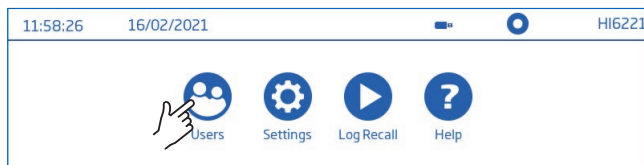

The function enables multiple-users configuration, rights management, and account creation.

On first access, the benchtop's name is used as default user name and no password is required. Default options are updated from the Users menu.

Function	Administrator*	Standard User
Enable account creation	<input type="checkbox"/>	—
Reset password	<input type="checkbox"/>	—
Delete account	<input type="checkbox"/>	—
Assign administration rights	<input type="checkbox"/>	—
View/Use Factory Settings reset	<input type="checkbox"/>	—
Customize settings	<input type="checkbox"/>	<input type="checkbox"/>
Add FTP information	<input type="checkbox"/>	<input type="checkbox"/>
Change password	<input type="checkbox"/>	<input type="checkbox"/>
View and delete log files	<input type="checkbox"/>	<input type="checkbox"/>

*Settings and configurations made by users with administrative rights can only be modified by users with identical rights.

Log in & Create New Account

1. Power the instrument.
Wait for the initialization process to complete.
2. Tap Skip on display to automatically enter Measurement screen, or alternatively, use the right arrow to run through the instrument's Startup Tutorial.

Note: To disable Startup Tutorial, tap the toggle button under Skip.

3. From Measurement screen, tap **Menu** key (☰) on the unit.
4. From System Menu screen, tap Users (👤) on display.
5. Tap Logout on display to enter Users screen.

As a default setting, HI6221 Admin account (with built-in administrator rights) is automatically created.

6. From Users screen, tap the plus symbol avatar.
7. Use the on-screen keypad to enter user name for new account.
8. Tap Enter on keypad to confirm.

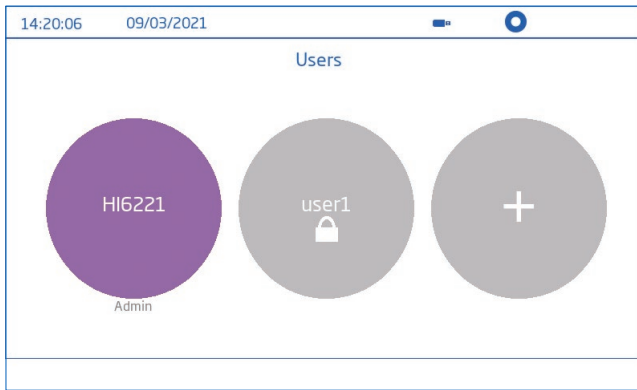

Log out & Switch User

1. From System Menu screen, tap Users (😊) on display.
2. Tap Logout.
3. Tap on user's account avatar.
4. Use the on-screen keypad to enter password.

Adding & Removing Users (Administrator only)

1. From Measurement screen, tap **Menu** key (☰) on the unit.
2. From System Menu screen, tap Users (😊) on display.
3. Tap Edit Users to enter Account Management screen and start editing.

The screenshot shows a mobile application interface for editing a user. At the top, the status bar displays the time "10:52:34", the date "06/03/2021", and the unit ID "HI6221". The form is divided into two columns. The left column contains: "User Name" with a text box containing "HI6221"; "Password" with an empty text box; "Icon Color" with a color picker showing "Quartz Pink", "Honeysuckle", and "Amethyst Orchid" options; and "Email Address" with a text box containing "user@email.com". The right column contains: "FTP IP Address" with a text box containing "0.0.0.0"; "FTP User Name" with an empty text box; and "FTP Password" with an empty text box. At the bottom right, there are two blue buttons: "Edit Users" and "Logout". A note at the bottom left states "*required for file sharing".

Note: use the FTP dedicated fields for file transfer of logged data.

Account Management

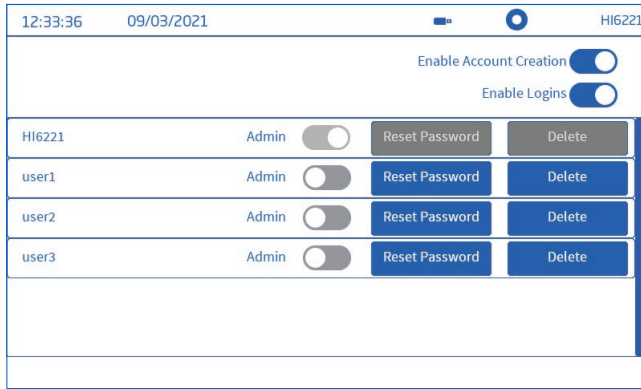

From Account Management screen users with administration rights can complete one or all of the following actions:

- Enable Account Creation
- Enable Logins
Each power up requires user selection before instrument enters measurement mode.
- Enable Admin i.e. assign administration rights to a standard user.
Note: For all three enable/disable functions, tap switch on display to toggle options.
- Reset Password
Select user name from the list of users.
Tap Reset Password. Old password has been replaced with default "1234" password. Users can update default password.
- Delete users
Select user name from the list of users.

Tap Delete. The instrument prompts for confirmation.

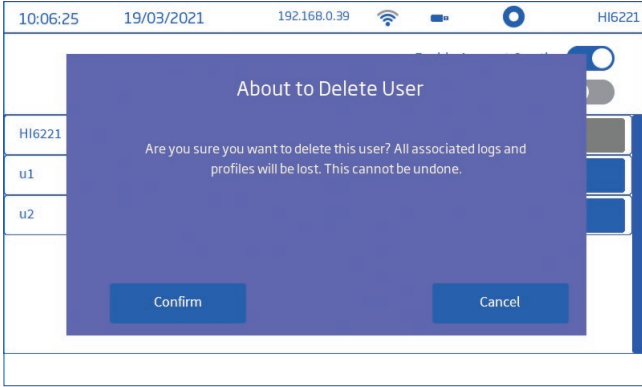

9.2. SETTINGS

Settings is the second item under the System Menu.

The function allows users to configure network connection and architecture, connectivity services, change system settings, and view Meter information.

Network, Connectivity, and System tabs permit users to navigate through all system setting options and operations. The following diagram presents an overview of the System's Settings options.

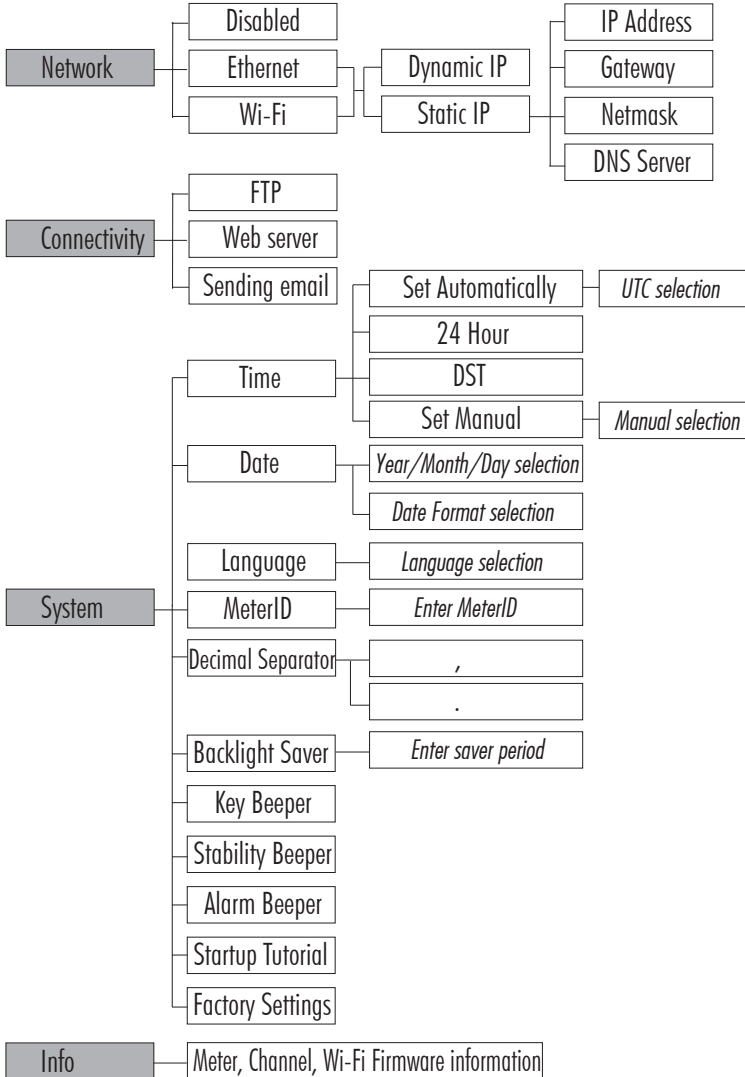

9.2.1. Network

Options: Disabled, Ethernet, Wi-Fi

This selection determines how measurement logs are shared.

The user can select network to be connected via Ethernet or Wi-Fi or Disabled. With connection enabled, the IP assignment can be set to Dynamic or Static.

For setting a Static IP address:

1. Tap the IP Address input field.
2. Type the address onto the on-screen keypad. Tap Done when finished.

Note: Follow the same steps to input Gateway, Netmask, and DNS Server details.

For Wi-Fi connection:

1. Tap Wi-Fi to select option. The Wi-Fi icon turns blue if information and connection are viable.
2. Tap Press to select network.
3. Tap Scan to start scanning network options.
4. Select preferred network.
5. Tap Done to confirm option.

The screenshot shows the Network settings interface. At the top, the status bar displays the time (12:01:39), date (06/03/2021), IP address (192.168.43.177), and signal strength. The main content area has a 'Network' header with three tabs: 'Disabled', 'Ethernet', and 'Wi-Fi'. The 'Wi-Fi' tab is selected and highlighted in blue. Below the tabs, there are three sub-sections: 'Connectivity', 'System', and 'Info'. Under 'Connectivity', there are three options: 'Dynamic', 'Static', and 'Hanna'. The 'Static' option is selected. Below these options, there are four input fields for configuration: 'IP Address' (192.168.43.177), 'Gateway' (192.168.43.161), 'Netmask' (255.255.255.0), and 'DNS Server' (192.168.43.161).

9.2.2. Connectivity

Connectivity options must be active to allow connectivity of the meter with other devices.

Tap on-screen switch to enable following options:

- FTP access to meter, permits log file transfer to a FTP site and to connect the meter FTP server to a client for log download.

- Meter web server, permits log file download to a web client.
- Sending emails, permits log files to be transferred by email.

Note: Email address is entered under User.

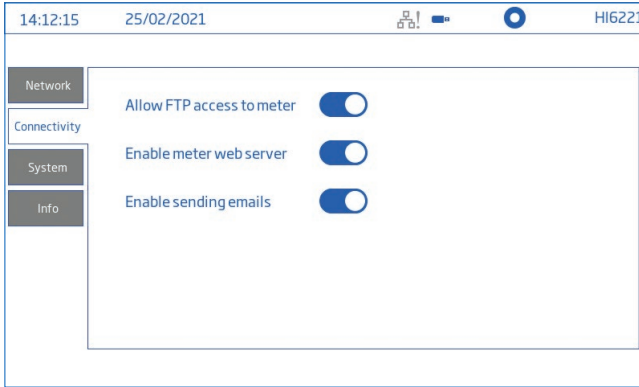

9.2.3. System

Options: Time, Date, Language, Meter ID, Decimal Separator, Backlight Savers, Beepers, Startup Tutorial, Factory Settings

Note: Use the scroll bar to view or select from entire settings list.

Time

Tap on-screen switch to enable or disable following options:

- Set Automatically (the benchtop meter must be connected to the internet)
- 24 Hour
- DST

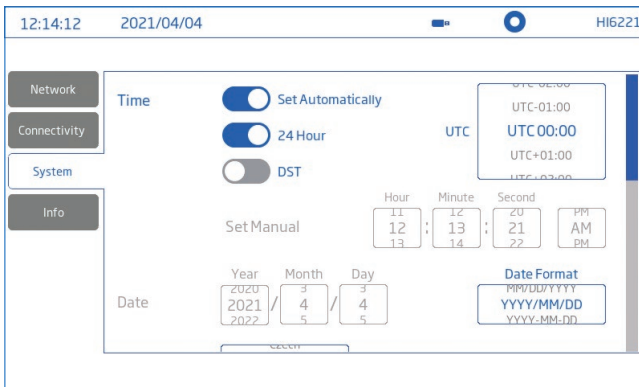

Set Automatically

- Direct selection from scrollable list of options
- UTC options:
 - from UTC 00:00 to UTC+ 14:00
 - from UTC 00:00 to UTC -12:00 (half hour increments)

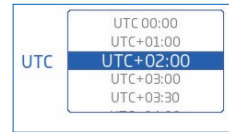

24 Hour (Set Manual)

- Direct selection from scrollable lists of options
- Hour, Minute, Second, Date, and Date Format

DST (Daylight Savings Time) seasonal time change is used in some locations that advances clocks (typically by one hour) during warmer months.

Date

- Year, Month, Date options, only with 24 Hour (Set Manual) enabled
- Choice of display formats: DD-Mon-YYYY; YYYY-Mon-DD; DD/MM/YYYY; MM/DD/YYYY; YYY/MM/DD; YYYY-MM-DD; Mon DD, YYYY

Language

- Direct selection from scrollable list of supported options
- Option allows users to change the meter's interface language.

Meter ID

Used to name the meter with a discrete name, location, or number. Tap Enter on keypad to save.

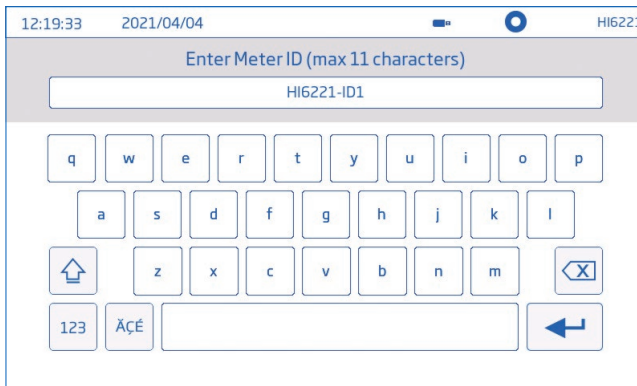

Tap on-screen switches (enable or disable function) or direct buttons (direct selection) for following settings:

Decimal Separator

Select comma or period for regional preference.

Backlight Saver

Enable or Disable option. Select from 1 to 60 minutes.

Note: *If the backlight turns off after the set period of time, tap screen to turn it back on.*

Beeper – Key, Alarm, Stability

When enabled, an audible signal alerts users in the event of a wrong key press, an alarm condition, or the stability threshold being exceeded.

Startup Tutorial

If disabled, Tutorial will not be shown upon powering on meter.



Factory Settings

Option restores System settings to their original factory values. This includes, resolution for measured data, temperature unit, view mode, alarm. Restoring factory settings deletes all user information, logs, or stored Profiles.

When option invoked, the instrument asks for confirmation.

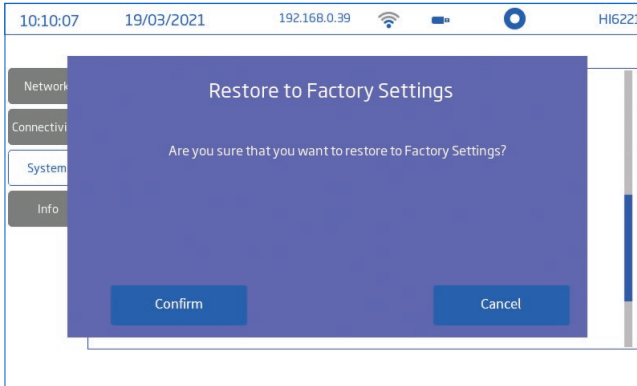

Note: Only visible to user with Administrative rights.

9.2.4. Info

This read-only section displays information on meter, channel serial number, and Wi-Fi firmware version.

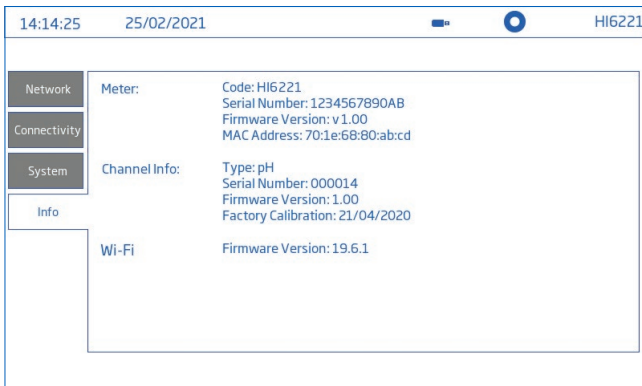

9.3. LOG RECALL

Log Recall is the third item under the System's Menu. From System Menu screen, tap Log Recall icon (▶).

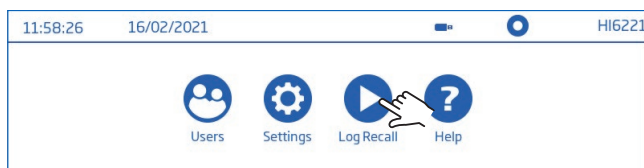

The item allows users access and management (selection, deletion, and sharing) of measurement data. Only the user who generated the data has access to the logs created by that user.

Depending on selected reading parameter (HI6221 supports pH, mV, and Rel.mV parameters), logged data is stored in parameter-specific csv. files.

Storage location – pH, mV, Rel. mV – is independent and organized in lots.

A lot (or file) can store 1 to 50 000 log records i.e. saved measurement data points.

One user can store at least 1 000 000 data points.

View

Data can be viewed, plotted (as graph), or tabulated (complete with date, time, and notes).

From the System Menu screen:

1. Tap Log Recall (▶) to access stored data. The instrument displays the Log History screen.
2. Tap Name field to select .csv file.
3. Tap View.

Name	Parameter	Start/Stop	#Samples
mV_20210319101211.csv	mV	10:12:11 19/03/2021 10:12:40 19/03/2021	30
pH_20210310100303.csv	pH	10:03:03 10/03/2021 10:03:05 10/03/2021	3
pH_20210310100311.csv	pH	10:03:11 10/03/2021 10:03:16 10/03/2021	6
pH_20210316151430.csv	pH	15:14:30 16/03/2021 15:14:51 16/03/2021	22
pH_20210318130618.csv	pH	13:06:18 18/03/2021 13:08:07 18/03/2021	110
relmV_20210319101247.csv	Rel. mV	10:12:47 19/03/2021 10:13:11 19/03/2021	25

- Tap graph (📈) or table (📄) icon on display, to have logged data either plotted on a graph or displayed in a tabulated form. Tap ⚙️ to modify the temperature unit. When shared, the logged files record the temperature unit selected at the time measurement was taken.

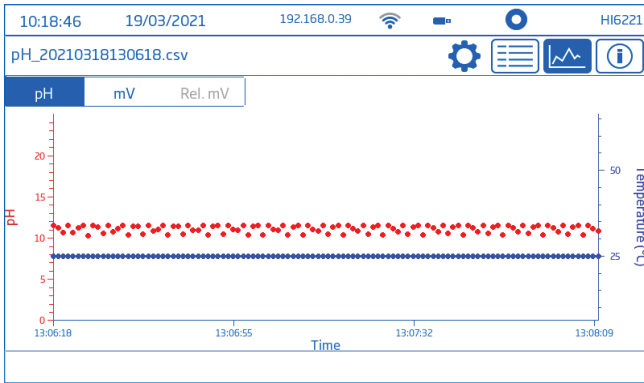

The screenshot shows the same data logging interface, but with the table view selected. The table displays the following data:

pH	mV	T(°C)	Date	Time	Notes
11.519	-267.350	25.0	18/03/2021	13:06:18	OK
11.293	-253.950	25.0	18/03/2021	13:06:19	OK
10.699	-218.690	25.0	18/03/2021	13:06:20	OK
11.569	-270.300	25.0	18/03/2021	13:06:21	OK
10.672	-217.090	25.0	18/03/2021	13:06:22	OK
11.230	-250.180	25.0	18/03/2021	13:06:23	OK
11.562	-269.860	25.0	18/03/2021	13:06:24	OK
10.333	-197.010	25.0	18/03/2021	13:06:25	OK
11.495	-265.930	25.0	18/03/2021	13:06:26	OK
11.381	-259.120	25.0	18/03/2021	13:06:27	OK

Tap information icon (ⓘ) on display for user and profile name, instrument name and serial number, channel, lot information, as well as GLP data.



Select All / Deselect All

Select the option to export all logs to a USB-A flash drive.

1. From System Menu screen, tap Log Recall symbol (▶) on display. Log History screen opens up.
2. Tap Select All button to select entire log history with one touch.
3. To exit select all mode, tap Deselect All.

With all files selected, tap Delete to empty the log or tap Share to transfer data.

Delete

From System Menu screen:

1. Tap Log Recall (▶) to access stored data. The instrument displays the Log History screen.
2. Tap to select required .csv file (one file) or use Select All option.
3. Tap Delete.
4. The instrument prompts for confirmation.

Once deleted, selected files can not be recovered and Log History screen is displayed blank.

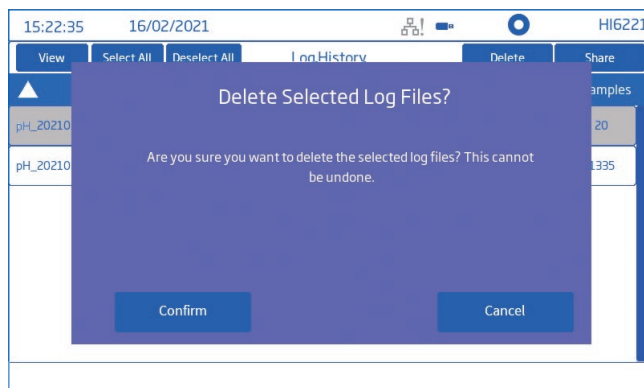

Share Options

USB-A and USB-C

Plug the USB flash drive into the unit in one of the USB ports located on the back.

1. From System Menu, tap Log Recall symbol () on display.
Log History screen opens up.
2. Select file (files) for transfer or use Select All option.
3. Tap Share.
Pop-up flyout is displayed.
4. Tap to select USB-A or USB-C.
5. Instrument prompts file transfer in progress.
6. Upon file transfer completion, instrument returns to Log History screen.

FTP

Make sure the meter is connected to the internet and the Allow FTP access to meter option enabled (see Connectivity section).

To connect via **FTP to meter server**:

1. On preferred FTP software, type the meter's IP address in the dedicated Host field.
2. Enter the username and password of the user currently logged in on the meter.



3. Connect to view the files logged on the meter.

To connect the **meter to an FTP server** and share logs:

1. In Users menu, type selected FTP server's IP address, username, and password in the dedicated fields.
2. From System Menu, tap Log Recall symbol () on display.
Log History screen opens up.
3. Select file (files) for transfer.
4. Tap Share.
Pop-up flyout is displayed.
5. Tap to select FTP. The files are now transferred in the root folder of the server.

Email

Make sure the meter is connected to the internet and the Enable sending emails option enabled (see Connectivity section). In Users menu (☺), type the email address in the required field.

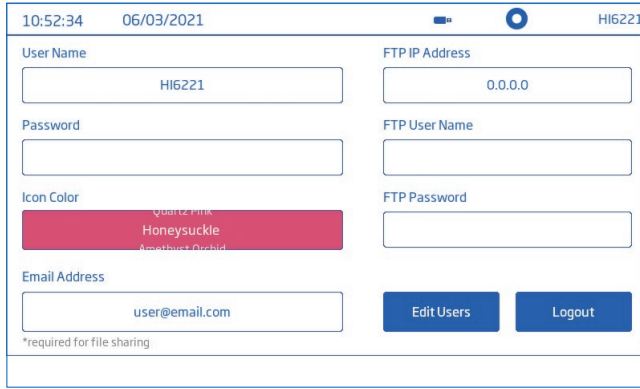

1. From System Menu, tap Log Recall symbol (▶) on display. Log History screen opens up.
2. Select file (files) for transfer or use Select All option.
3. Tap Share. Pop-up flyout is displayed.

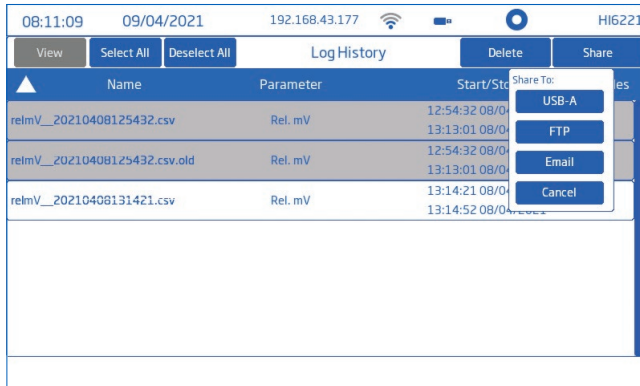

4. Tap to select Email.
5. Instrument prompts file transfer in progress.
6. Upon file transfer completion, instrument returns to Log History screen.

Web server

Use any browser to access the web server and download log files and tags. Make sure the HI6221 is connected to the internet and the Enable meter web server option is active (see Connectivity section).

Note: Both the meter and the device the browser is accessed from have to be connected at the same network.

1. Type the meter's IP address in the browser.



2. Enter the username and password of the user currently logged in on the meter.

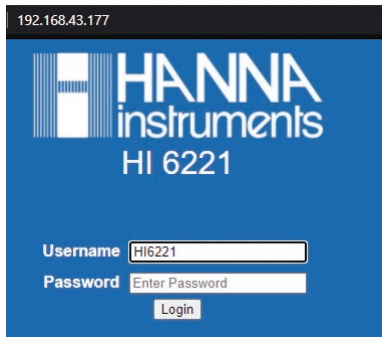

3. "Successfully logged in." is displayed and the user gains access to logs and tags. Click on file to download to the PC.

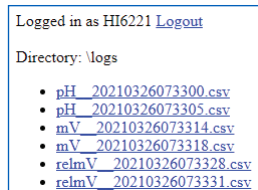

PC Connection

The logged data can be transferred from the benchtop to a PC.

- Use the USB-C cable to connect the meter to the PC.
- The meter will appear as a flash drive on the computer.
- Save files to the PC. All logs will be listed as .csv files.

The .csv files may be opened with any text editor or spreadsheet application.

All features of the spreadsheet program can be used to analyze and graph the data.

9.4. HELP

Help is the fourth item under the System Menu.
From the System Menu screen, tap Help (?).

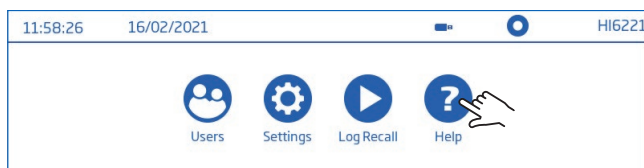

The item supports users with a brief overview of the System's main functionalities.
Tap to navigate through sections and subsections for general guidelines and video support.

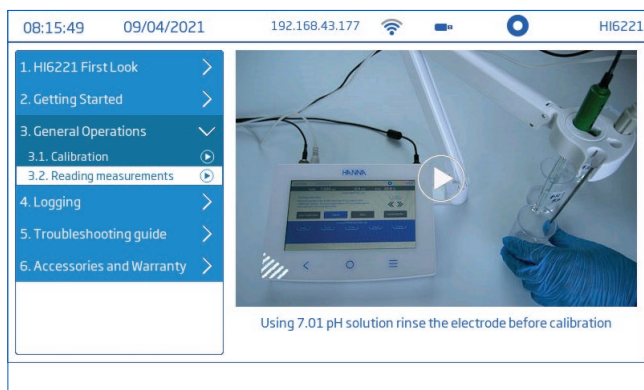

Tap the video area to play or stop one of the three video-supported Help segments:

- 1.5. Setting up the device
- 3.1. Calibration
- 3.2. Reading measurements

Tap **Menu** key (≡) once to increase video speed. The instrument supports, with each tap, three playback speeds: normal (x1), medium (x2), and fast (x4).

10. MEASUREMENT & ELECTRODE SETUP MENU

From the Measurement screen, tap Measurement Setup icon on display to open up the choices stacked up on the left side of the screen.

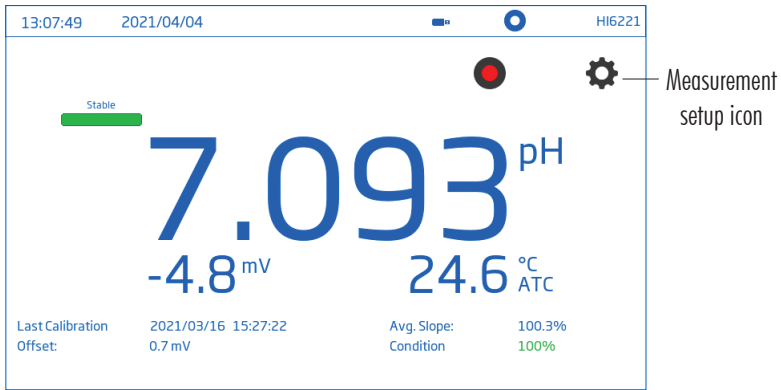

Setup tabs

Active during system and measurement configuration.

When any item in the list is accessed, a submenu will open up.

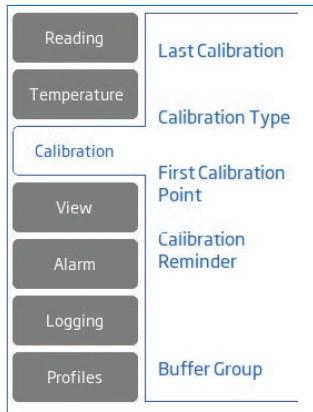

Setup Table Overview

Reading				
Parameter	pH	mV	Rel.mV	
Resolution	0.1 0.01 0.001	1 0.1	1 0.1	
Stability Criteria	Accurate, Medium, Fast			
Reading Mode	Direct, Direct/Autohold			
Temperature				
Parameter	pH	mV	Rel.mV	
Temperature Source	Manual, Automatic			
Temperature Unit	°C, °F, K			
Manual Temperature	-20.0 to 120.0 °C -4.0 to 248.0 °F 253.0 to 393.0 K			
Isopotential Point	4.010 pH 7.000 pH	—	—	
Calibration				
Parameter	pH	mV	Rel.mV	
Last Calibration	Calibrate Clear	—	Calibrate Clear	
Calibration Type	Automatic Semiautomatic Manual	—	—	
First Calibration Point	Point Offset	—	—	
Calibration Reminder	Disabled Daily Periodic	—	Disabled Daily Periodic	
Buffer Group	User Defined	—	—	

View

Parameter	pH	mV	Rel.mV
Display	Basic Simple GLP Full GLP Graph Table	Basic Graph Table	Basic Simple GLP Graph Table

Alarm

Parameter	pH	mV	Rel.mV
High / Low pH	-2.000 to 20.000 pH	—	—
High / Low mV	-2000.0 to 2000.0 mV		
High / Low Temperature	-20.0 to 120.0 °C -4.0 to 248.0 °F 253.0 to 393.0 K		

Logging

Parameter	pH	mV	Rel.mV
Type	Automatic Manual Autohold (only for Direct/Autohold mode)		
Sampling Period (Automatic logging)	1, 2, 5, 10, 30 sec. 1, 2, 5, 10, 15, 30, 60, 120, 150, 180 min.		
New Lot (Manual or Autohold logging)	Create		
Sample ID (Manual or Autohold logging)	None Increment		
Sample ID Prefix (Manual or Autohold logging)	0 to 999		

Profiles

Parameter	pH	mV	Rel.mV
Current Profile	Save As Save Delete		
Load Profile	Available profiles		

10.1. READING

Options: Parameter, Resolution, Stability Criteria, Reading Mode

13:08:32		02/03/2021		HI6221	
Reading	Parameter	pH	mV	Rel. mV	
Temperature	Resolution	0.1	0.01	0.001	
Calibration	Stability Criteria	Accurate	Medium	Fast	
View	Reading Mode	Direct	Direct/Autohold		
Alarm					
Logging					
Profiles					

Parameter

Options: pH, mV, Rel. mV

Option allows users to configure the meter for pH, mV (ORP), or Rel. mV (ORP with calibration) measurements.

Configuration is done through direct selection.

See Setup Table Overview for all options.

Resolution

Option allows users to select desired resolution based on selected mode.

See Setup Table Overview for all options.

Stability Criteria

Option allows users to set the stability criterion for selected mode based upon the stability setting selected.

The stability indicator on the measurement display will show partially while the measurement is changing, and show a full green bar when the measurement stability criteria has been fulfilled.

- Accurate

Recommended option for applications where high accuracy is required. Measurement is recognized as stable using more critical criteria evaluating measurement fluctuations.

- Medium

Recommended option for applications where average accuracy is required.

Measurement is recognized as stable using less critical criteria evaluating measurement fluctuations.

The measurement may still change after registering stable.

- Fast

Recommended option for applications where speed of delivery has priority.

Reading Mode

Options: Direct, Direct/Autohold

Tap to select option.

When Direct is selected, the measurement changes and the stability of the measurement is continuously evaluated. Unstable (blinking) or Stable status indicator are displayed above the progress bar.

When Direct/Autohold is selected, a lock icon (🔒) is displayed between the log and Measurement Menu icons. Tap the icon to initiate an Autohold measurement. Depending on parameter selected, pH or mV icons will be displayed.

Autohold indicator is displayed blinking above stability bar until the measurement is stable.

When stable, the indicator stops blinking and the measurement will freeze at the current value. Tap the pH or mV (🔒) icon to return to direct measurement.

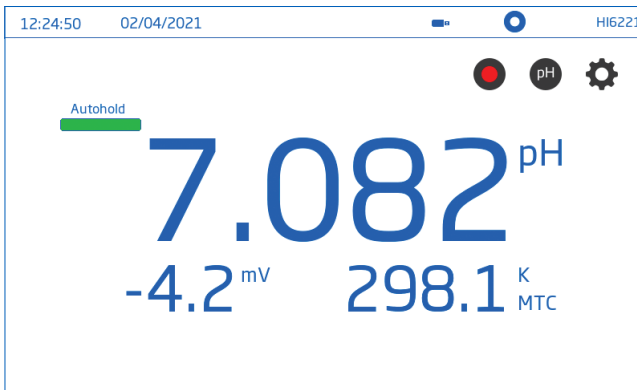

10.2. TEMPERATURE

Options: Temperature Source, Temperature Unit, Manual Temperature, Isopotential Point

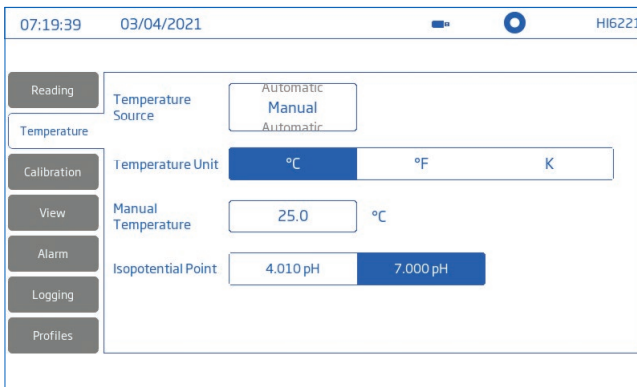

Temperature Source

Menu is used to select between the physical temperature input source (Automatic) or to enter the sample temperature value manually (Manual).

- For Automatic selection, a temperature probe must be plugged and placed in the measured sample. ATC will be displayed next to the temperature measurement on the pH display. The mV/Rel. mV display will indicate temperature value.
- For Manual selection (or the temperature probe is not plugged in), MTC will be displayed next to the temperature measurement on the pH display. Manual will be displayed next to the temperature measurement on the mV/Rel. mV display. The sample's temperature will need to be entered.

Temperature Unit

Users select desired temperature unit (Celsius, Fahrenheit, or Kelvin degrees).

Manual Temperature

To input manual temperature (Manual selected under Temperature Source, or with no temperature probe):

1. Select the desired temperature unit.
2. Tap on Manual Temperature field. Use the on-screen keypad to enter sample's temperature.

Isopotential Point

Options: 4.010 pH, 7.000 pH

To input Isopotential point, tap to select desired isopotential point (pH measurement only).

Note: *Isopotential point is the point at which temperature has no effect on pH readings.*

Unless noted with electrode, use 7.000 pH.

10.3. CALIBRATION

Options: Last Calibration, Calibration Type, First Calibration Point, Calibration Reminder, Buffer Group

Note: *See Calibration section for more information.*

Calibration Type

- Automatic
When option is selected, the instrument selects the closest buffer value to that of the pH sample being measured, from the Buffers in Use list.
- Semiautomatic
When option is selected, the instrument selects the closest buffers to that of the pH sample being measured, from both Available Standard and Custom Buffers lists.
The user can then manually select between buffers that are close in value when the angle bracket turns blue.

- Manual

When option is selected, the user manually selects the required buffer value from both Available Standard and Custom lists.

First Calibration Point

Point and Offset are the two options available.

- With Point selected, a new buffer value can be added to an existing calibration. This prompts an automatic reevaluation of the electrode slope.
- With Offset selected, the new buffer calibration point can create a constant offset to all existing pH calibration data performed with a minimum of two pH buffers.

Calibration Reminder

This option allows the user to set:

- Daily-calibration interval (in hours and minutes)
- Periodic calibration interval (in days, hours, and minutes)

If a calibration is not performed within the calibration interval indicated, a “Calibrate probe” warning message is triggered and runs along the bottom of the measurement screen.

Buffer Group

This option allows the user to select Buffers in Use for calibrating a pH electrode when using Automatic calibration type.

Up to 5 buffers may be moved from Standard or Custom buffers in the Buffers in Use column. Select buffer and forward arrow to move to Buffers in Use column.

To edit and add a custom buffer, from the Measurement screen:

1. Tap the Measurement Menu icon (⚙️) on the display.
2. Set pH Parameter.
3. Tap Calibration tab.
4. Tap Edit next to Buffer Group.

5. Select from available input field in the Available Custom Buffers list.
6. Tap Edit to enter buffer value at the calibration temperature value and Enter to confirm.
7. Repeat with up to 5 custom values.
Once the maximum number has been reached, to add another custom value, users must delete one of the previously set values.

10.4. VIEW

pH options: Basic, Simple GLP, Full GLP, Graph, Table

mV options: Basic, Graph, Table

Rel. mV options: Simple GLP, Basic, Graph, Table

Option allows users to select preferred display configuration.

Configuration is done through direct selection from the Display window.

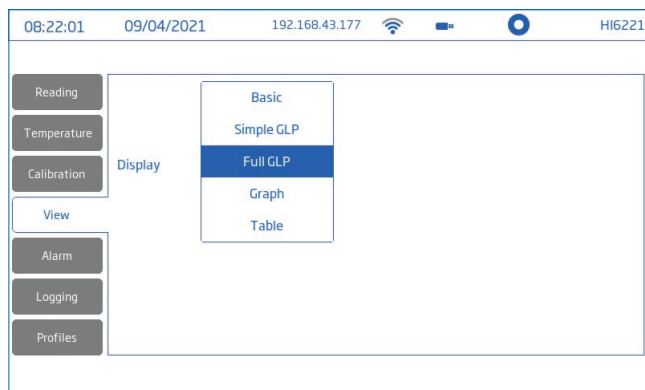

Basic

Basic screen displays the measured value, measurement unit as well as temperature-probe status.

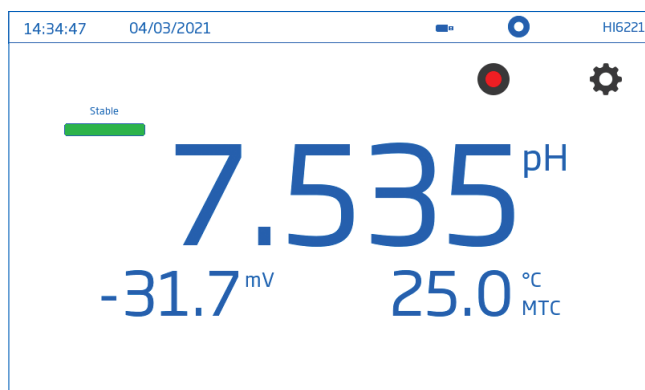

Simple GLP

In addition to data displayed when Basic option is selected, Simple GLP screen also displays: last calibration date and time, Offset value, average slope (Avg. Slope), and electrode condition (Condition).

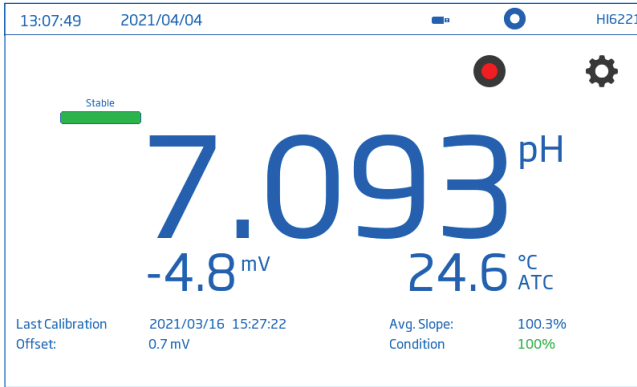

Note: If no calibration has been made, Not Calibrated is displayed.

Full GLP

In addition to data displayed when Simple GLP option is selected, Full GLP screen also displays: electrode symbol, used buffers trays together with calibration date, time, and temperature probe status.

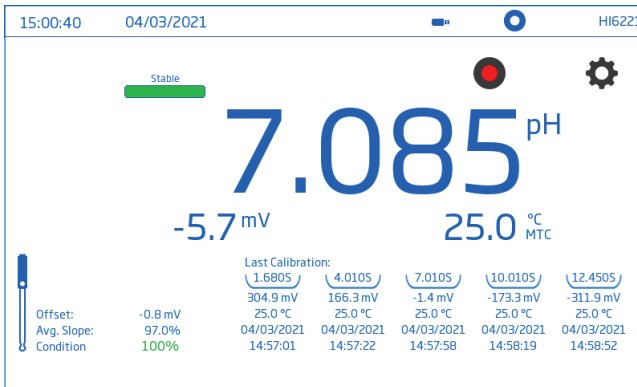

Graph

When Graph is selected, the measured value is plotted as a graph.

To zoom in on a graph:

1. Select Time or parameter axis.
2. With axis selected, pinch or drag on the display.

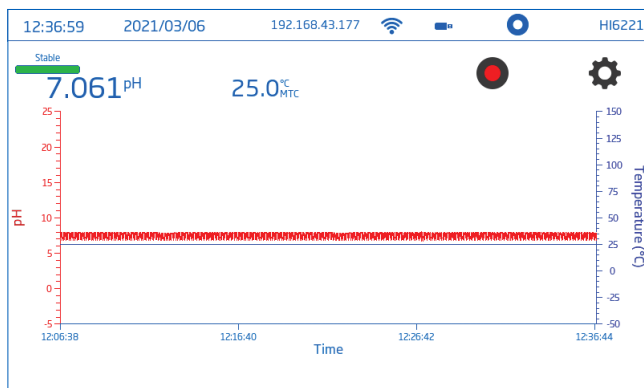

Table

When Table is selected, the measured values are displayed tabulated (complete with date, time, and notes made during logging). The newest data is displayed on the top of the table.

pH	mV	T(°C)	Time	Date	Notes
7.040	-1.7	24.8	08:24:29	09/04/2021	
7.040	-1.7	24.8	08:24:28	09/04/2021	
7.040	-1.7	24.8	08:24:27	09/04/2021	
7.040	-1.7	24.8	08:24:26	09/04/2021	
7.040	-1.7	24.8	08:24:25	09/04/2021	
7.040	-1.7	24.8	08:24:24	09/04/2021	
7.040	-1.7	24.8	08:24:23	09/04/2021	
7.040	-1.7	24.8	08:24:22	09/04/2021	
7.040	-1.7	24.8	08:24:21	09/04/2021	
7.040	-1.7	24.8	08:24:20	09/04/2021	
7.040	-1.7	24.8	08:24:19	09/04/2021	

10.5. ALARM

Options: High pH, Low pH, High mV, Low mV, High Temperature, Low Temperature

Option allows users to set the threshold limits for the measured parameters.

When the parameter is enabled and the the measurement exceeds the high-limit value or drops below the low-limit value, the alarm is triggered.

An alarm message will appear on the message banner. If the Alarm Beeper is enabled (System Menu / System / Alarm Beeper), an audible beep will be heard.

Note: *high-parameter values cannot be lower than low-parameter ones.*

To set an alarm limit:

1. Tap on switch to enable low or high parameter threshold option.
2. Use the on-screen keypad to enter the value.
3. Tap Enter to confirm or Cancel to exit and return to measurement setting options.

The screenshot shows the HI6221 measurement setup menu. The top status bar displays the time 14:26:50, the date 26/02/2021, and the device ID HI6221. The main menu is divided into several sections: Reading, Temperature, Calibration, View, Alarm, Logging, and Profiles. The Alarm section is currently selected and shows the following settings:

Parameter	High Limit	Low Limit	Unit
High pH	8.000		pH
Low pH		6.000	pH
High mV	200.0		mV
Low mV		100.0	mV
High Temperature	50		°C
Low Temperature		10	°C

10.6. LOGGING

Options: Logging Type, Sampling Period (Automatic), File Name (Manual and Autohold), Sample ID (Manual and Autohold)

Logging Type

- Automatic
Measured data is logged automatically at predefined time intervals (i.e. Sampling Period).
A file name is automatically generated:
 - pH log files start with pH. The file is named by year month day, and starting time e.g., pH_20210329085101
 - Relative mV log files start with relmV e.g., relmV_20210309095704
- Manual
Measured data is logged every time start log icon (🔴) is tapped on display.
- Autohold
Logging type available with Direct/Autohold reading mode selected.

Note: Manual and Autohold records are stored in the same log file, i.e. data logged on different days is stored in the same lot. Automatic records are stored separately.

Data logged with Autohold option selected, is identified by the H in the Notes column.

Sampling Period

Option available only with Automatic logging type selected.
Time-interval options are selected from scrollable list.

File Name

Option available only with Manual and Autohold logging type selected.

To create a file name from Logging screen:

1. Tap Create.
2. Use the on-screen keypad to enter a file name of maximum 13 characters.
3. Tap Enter on keypad to confirm.
The instrument automatically ends the Manual log file name in `_pH_.csv`, `_mV_.csv`, `_relmV_.csv` depending on selected reading mode.

Sample ID

Option allows manual and autohold samples to be labeled with an identification.

There are 4 options available: none, a numerical ID that increments with each new sample logged, a text label, or a text label with numerical ID.

With Increment option selected (tap to select):

1. Tap Sample ID Prefix.
2. Use the on-screen keypad to enter a text prefix, of maximum 15 characters, to the sample name.
3. Tap Enter on keypad to confirm.
4. Select ID number from scrollable list.

10.7. PROFILES

Options: Save As, Save, Delete

A profile is a sensor setup complete with required measurement unit, temperature unit, display preference, and alarm threshold options.

Once saved the profile can be loaded for applications that require similar configurations.

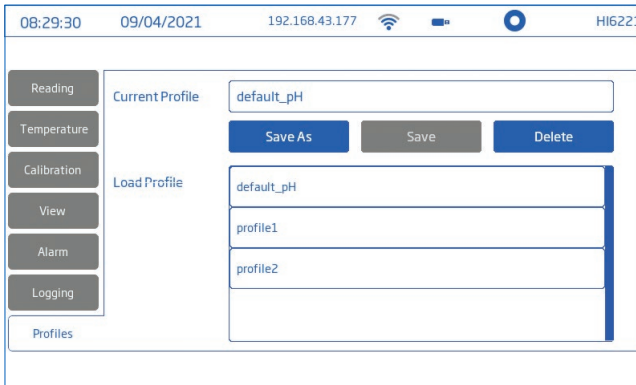

To save a profile, having previously configured all other application-specific options, from the Measurement screen:

1. Tap Measurement Menu (⚙️) on display.
2. Tap Profiles tab.
3. Tap Save As and use the keypad to enter name for new profile.
4. Use Enter on keypad to confirm.

Once saved, the profile name is added to the Load Profile list.

To select from the predefined list of profiles:

1. Tap to select the profile to be uploaded from the Load Profile list.
2. Profile name is automatically entered in the Current Profile field.
3. Start measuring.

11. CALIBRATION

Interface Calibration Overview

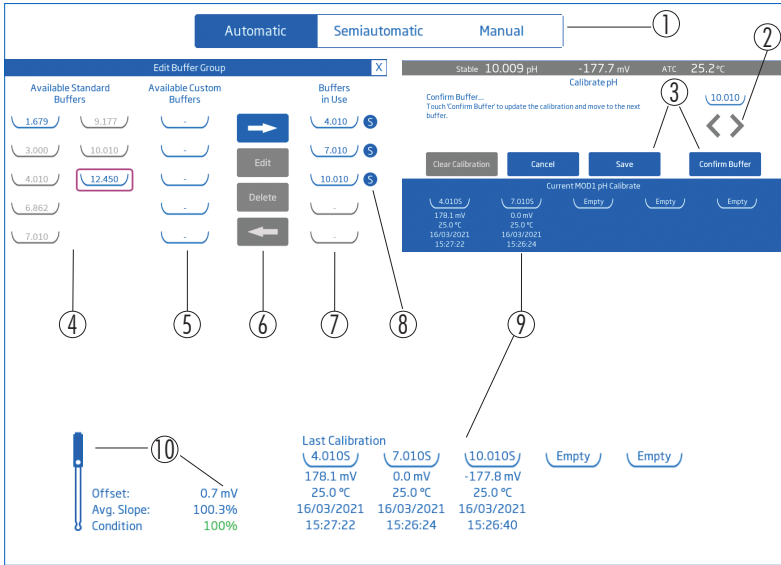

- 1 Calibration type
- 2 Forward or backward navigation, sequence of steps
- 3 Save and Confirm buffers, calibration procedure
- 4 Standard Buffers trays, with buffer selected for transfer (rectangular outline)
- 5 Custom Buffers trays
- 6 Buffer management
- 7 Buffers in Use
- 8 Standard buffer symbol, S, or C when calibrating with custom buffers
- 9 Electrode calibration details for buffer used (in tray)
- 10 Electrode symbol with Offset, Average Slope, and electrode condition (basic indication of overall electrode status)

11.1. pH CALIBRATION

Calibration Guidelines

- Set up a routine service schedule where measurement integrity is validated.
- Do not handle the sensing surfaces of the sensors.
- Avoid rough handling and abrasive environments that can scratch the reactive surfaces of the sensors.
- For best technique, use a rinse beaker and a separate calibration beaker for each buffer. Discard buffers after use.
- Do not return the used buffers to the bottles of “fresh” buffer.
- For measurements across a temperature gradient (when water temperature is drastically different from the buffers), allow the electrodes to reach thermal equilibrium before conducting calibrations or making measurements.
- During calibration the temperature probe should be in the calibration buffer.

pH Calibration Type

There are three options available with buffer selection from 8 predefined standards and 5 user-defined custom values:

Automatic

- Instrument automatically selects from Buffers in Use group.

Semiautomatic

- Instrument automatically selects from all available standard and custom buffers.
The user can manually select between buffers that are close in value when the angle bracket turns blue.

Manual

- Manual buffer input from all available standard and custom values.

Automatic Calibration

With this option selected, the [HI6221](#) automatically selects the closest buffer to the pH value being measured from all active buffers selected as Buffers in Use.

Selecting Buffers in Use, Standard or Custom (navigation guidelines)

To move buffers from the Available Standard Buffers or Available Custom Buffers trays to the Buffers in Use trays:

1. From Measurement screen, tap Measurement Menu icon (⚙️).
2. Select pH Reading Parameter, and tap Calibration tab next.

3. Tap Edit.

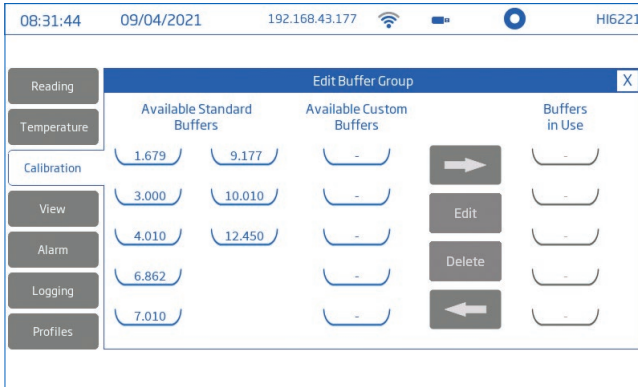

4. Tap to select from the Available Standard Buffers or Available Custom Buffers trays. A rectangular outline highlights buffer to be transferred.

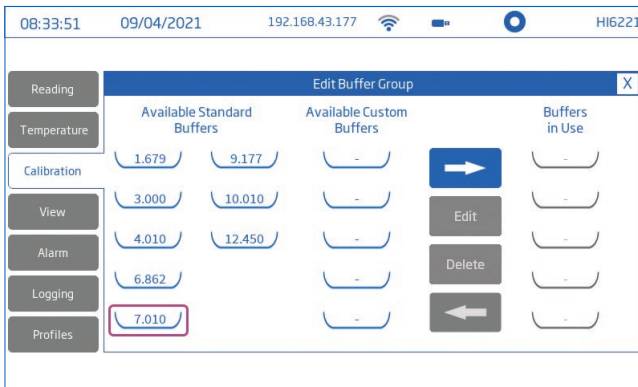

- For standard values, tap active forward arrow to move buffer in the Buffers in Use column. A small icon (S) on display, next to the buffer value, indicates calibration with standard buffer. Repeat with up to 5 buffers.



- For custom values, tap an empty tray and follow the Editing Custom Buffers Values steps.

Editing Custom Buffer Values (navigation guidelines)

With Calibration tab selected:

- Tap Edit next to Buffer Group.
- Tap to select an empty tray from the Available Custom Buffers column.
- Tap Edit.
- Use the numeric keypad to enter value.

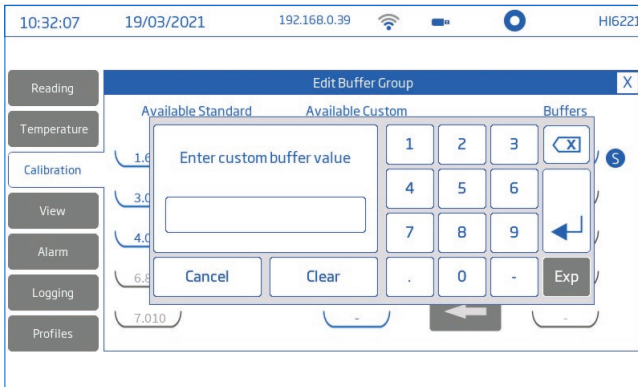

- Tap Enter on keypad to confirm (tap Cancel or Clear to return to editing mode).
- Tap on tray with newly-entered custom value. A rectangular outline confirms that buffer can be transferred to Buffers in Use.
- Use forward arrow to move custom buffer into Buffers in Use column.

Repeat with up to 5 buffers.

A small c icon on display (**C**), next to the custom value, indicates calibration with custom buffers.

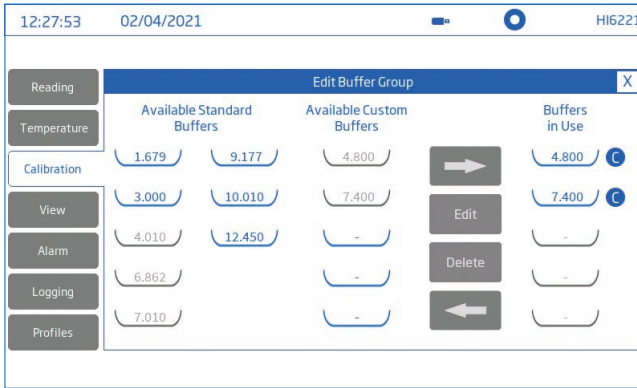

pH Calibration Procedure using Automatic Calibration

With the electrode and temperature sensor connected to the meter:

1. Select the correct buffer group or buffer value for calibration.
2. Select Manual Temperature source if calibration is done without a temperature sensor.
3. Remove the plastic protective cap from the probe and rinse the electrode with purified water.
4. Fill a rinse beaker 2/3 full with the first buffer solution.
5. Swirl the electrode and temperature sensor in the buffer solution.
6. Raise and lower the probe several times. Discard the solution.
7. Fill the calibration beaker 2/3 full with the first buffer solution.
8. Slowly place the electrode and temperature sensor in the selected buffer. Dislodge bubbles that may adhere to the sensors.

For most applications it is recommended to start with pH 7.01 buffer (or pH 6.86).

Use calibration buffers that bracket the samples pH.

For acidic samples it is recommended to use pH 4.01, 3.00, and/or 1.68 buffers.

For alkaline samples it is recommended to use pH 9.18, 10.01 and/or 12.45 buffers.

9. Tap Clear Calibration to start a fresh calibration and clear all previously used buffers.
If using a new pH electrode it is recommended to tap Clear Calibration to clear all buffers and start new.
10. Rinse the electrode and temperature sensor in the buffer, place in the rinse beaker then calibration beaker.

A → Buffer has been recognized. Waiting for reading to stabilize.

B → Check the buffer value and use fresh buffer if:

- The buffer cannot be recognized.

- The current reading is outside of the acceptable window.
- The current buffer is generating a slope over the of acceptable window.
- Temperature is outside of the acceptable window.
- The current buffer is generating a low slope.
- The current buffer cannot be confirmed due to an inconsistency with the previous calibration (additionally, clear the old calibration to continue.)



Check the buffer value and choose a new buffer if:

- The current buffer has already been accepted or is too close to a buffer that has been used.

Note: *If probe's response time is slow, clean the probe then repeat the calibration.*

11. Tap Confirm Buffer to update the calibration.
Repeat procedure for a total of up to 5 calibration points.
12. Tap Save to update the calibration and return to the calibration setting screen. Tap the **Home** key (○) to return to measurement.

Semiautomatic Calibration

In addition to selecting from 8 standard options, users can define 5 custom buffers to be used for calibration.

With the Semiautomatic Calibration selected, [HI6221](#) automatically recognizes the closest buffer to the pH value being measured from all available (standard and custom) buffers.

Users can either confirm recognized buffer or change to another available buffer value by tapping the angle pointing arrow.

Manual Calibration

With this option selected, the [HI6221](#) uses from all available buffer values (standard and custom).

1. Select Calibration tab.
2. Tap to select Manual calibration type.
3. Tap Calibrate on display.
4. Tap the angle forward pointing arrow on display to select correct buffer value.

11.2. RELATIVE mV CALIBRATION

The Rel. mV calibration or ORP calibration allows the user to:

- Perform a single point, custom calibration (Rel. mV).
- Restore the factory calibration (Clear Calibration).

The Oxidation-Reduction Potential (ORP), displayed in mV, is the voltage that results from the difference in potential between the platinum (or gold) ORP sensor and the silver/silver chloride reference electrode.

ORP values are not temperature compensated, although ORP values can change with temperature (e.g. reference electrode potential changes, sample equilibrium changes). It is important to report ORP values together with the reference electrode used and the temperature.

The inert noble metal ORP surface provides an electron-exchange site with the sample (or standard) and its surface. The electron exchange is typically very fast in well-poised solutions (e.g. standards), but may be lengthier in actual samples.

Calibration establishes a baseline that can be used as a comparison for future work. Calibration is used to compensate for changes due to contamination of the platinum surface and drift in the reference electrode. A relative mV calibration can also be made to remove the voltage attributable to the Ag/AgCl reference electrode, to display the ORP versus a SHE (Standard Hydrogen Electrode).

This is an arithmetic correction and is correct only at the standard temperature. For example, [HI7022](#) ORP Test Solution reads 470 mV at 25 °C versus the Ag/AgCl reference. The ORP mV versus a SHE would be 675 mV (add 205 mV to the observed value).

Note: The user has to change the actual electrode to an ORP sensor and Parameter must be changed to Rel. mV for use with ORP electrodes. Suggested ORP models are [HI3133B](#), [HI4430B](#), or [HI3230B](#).

Please see Setup Table Overview for details on configuration parameters and values.

When switching between Parameters (pH and mV, or Rel. mV), wait a few seconds to accommodate meter reconfiguration.

Rel. mV Calibration Procedure

1. Tap Calibrate and the meter will open a Rel. mV calibration screen.

The screenshot shows a calibration screen titled "Calibrate Rel.mV". At the top, it displays the time "08:40:07", the date "02/04/2021", and the model number "HI6221". The screen contains two input fields: "Absolute mV" with a value of "-11.1" and "Relative mV" with a value of "1961.4". Below these fields is a text box that says "Press 'Save' to update Rel mV.". At the bottom, there are three buttons: "Clear Calibration", "Cancel", and "Save".

2. Place ORP electrode tip into a beaker of standard or a sample with known value [HI7021](#) (ORP solution for platinum and gold electrodes) reads 240 mV at 25°C, [HI7022](#) (ORP test solution for platinum and gold electrodes) reads 470 mV at 25 °C.
3. Tap the Relative mV box and a flyout calibration window appears.
4. Tap Clear to remove previous values from the box.

5. Use the keypad to enter the value of the standard.
6. Tap Enter on keypad to confirm and enter the value.
7. When a stable value is reached, tap Save.
The meter returns to the Rel. mV calibration setup screen.
8. Tap direct **Home** key (○) to return to Measurement screen.

To clear calibration:

1. Tap Clear in calibration screen.
2. The instrument prompts for confirmation.

12. MEASUREMENT

Options: Direct Readings, Direct/Autohold Readings

When Direct is selected, sample measurements are displayed continuously.

When Direct/Autohold is selected, measurement reading is held on display when measurement stability is reached. This option removes the subjective nature of stability as a measurement that has not reached equilibrium will not be used. Only after the chosen stability criteria has been met will the meter go into the Direct/Autohold mode.

12.1. MEASUREMENT TIPS

1. Connect the electrode to be used to the appropriate meter input. Make sure the electrode has been recently calibrated and is working correctly.
2. Place electrode into the [HI764060](#) electrode holder for easy transfer in and out of containers during calibration, sample measurement, and storage.
3. Rinse with purified water between buffers and / or samples.
4. Blot (never rub) the glass pH sensor with a lint-free tissue between buffers and samples.
5. To limit sample contamination, pour 2 beakers of buffers and samples. Use one beaker to rinse the sensor, and then use the second for measurement.
6. Gently stir the test sample to ensure the sensor is measuring a representative sample.
7. Open the fill hole cover and keep the fill solution topped off to permit the fill solution to flow through the ceramic junction and maintain a stable reference signal.

Note: Use the same size beaker and immersion depth for samples and buffers.

8. If measuring across a temperature gradient, allow the sensor to reach temperature equilibrium. If using manual temperature compensation input the sample temperature.
9. Once the reading indicates Stable, record measurement data.
10. Remove the electrodes from the sample, repeat steps 3, 4 and then place into the next rinse, then test sample.
11. Repeat the procedure for all samples. When all samples have been measured, rinse the pH electrode and replace storage cap with storage solution. Replace fill hole cover.

Note: When working without a temperature sensor, ensure that both calibration and measurements are done at the same temperature. This requires manual input of temperature value to allow the meter to perform buffer temperature correction.

12.2. DIRECT READINGS

From Measurement screen, tap the Measurement Menu icon () on display. Next,

- Tap to select from supported parameters.
- Tap Direct to select direct Reading Mode.

- Place the electrode tip and the temperature probe approximately 4 cm (1.5") into the sample to be measured. Allow time for the electrode to stabilize.
- Unstable status indicator on the screen until measurement is stabilized.
- The measured pH value is displayed on the LCD, together with GLP information and display preferences.

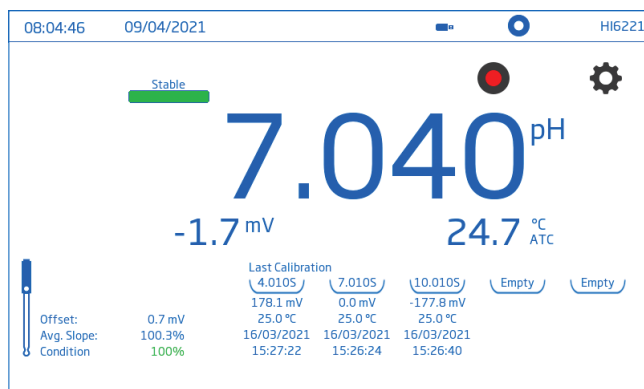

12.3. DIRECT / AUTOHOLD READINGS

From Measurement screen, tap the Measurement Menu icon (⚙️) on display. Next,

- Tap to select from supported parameters.
- Tap Direct/Autohold to select direct/autohold Reading Mode.
- Place the electrode tip and the temperature probe approximately 4 cm (1.5") into the sample to be tested.
- The measured parameter value will be displayed on the LCD.
The Autohold indicator is displayed blinking until the stability criteria is reached.
The measured value is held on the LCD and Autohold indicator stops blinking.
- To return to direct Reading Mode, tap pH icon on display (pH).

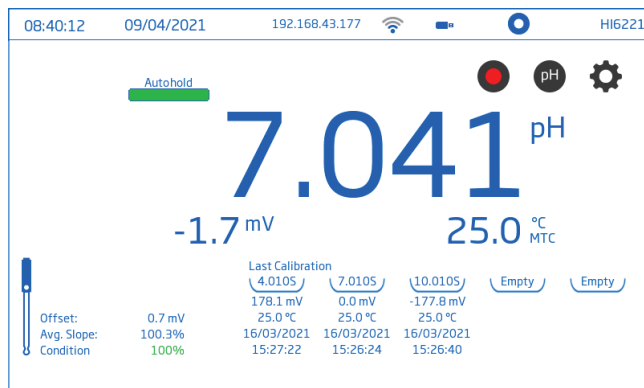

13. ERROR MESSAGES

The instrument shows clear warning messages (refer to the instrument's on-display message area, bottom of the screen) when erroneous conditions appear, and when measured values are outside the expected range.

The information below provides an explanation of the errors and warnings, and recommended action to be taken.

Displayed Message	Explanation & Recommended Action
"Temperature sensor broken"	Temperature sensor needs to be replaced.
"Temperature under/over range"	Temperature outside specified range. Verify the temperature probe is correctly connected to the meter. Replace probe if necessary.
"Under/over compensation range"	During pH calibration, the temperature is under/over the pH buffer compensation limit.
"mV under/over range"	Outside range in the corresponding scale. Ensure the glass bulb and reference junction are submerged and the sample is within specified range. Check that the glass bulb is completely filled with electrolyte and there are no trapped air bubbles.
"Broken electrode"	The meter fails to calibrate or gives faulty readings. Replace the electrode.
"pH over range"	Occurs when apparent pH value is more than 20.0 pH. Dry membrane (or junction). Soak electrode in HI70300 Storage solution for at least 30 minutes.
"pH under range"	Occurs when apparent pH value is less than -2.0 pH. Dry membrane (or junction). Soak electrode in HI70300 Storage solution for at least 30 minutes.
"pH out of calibration range"	Displayed when the measured value is outside calibration range.
"Rel. mV offset range"	Outside range in the corresponding scale. Ensure the glass bulb and reference junction are submerged and the sample is within specified range.
"Rel. mV under/over range"	Check that the glass bulb is completely filled with electrolyte and that there are no trapped air bubbles.
"Factory calibration expired"	Contact the Hanna technical support for the periodic factory calibration.

14. LOGGING

Three logging types are available: Automatic, Manual, and Autohold.

Automatic logging

- Readings are logged (●) at predefined period intervals.
Sampling interval options range from 1 second to 180 minutes.
- Records are continuously added to it until the session stops.
- For each automatic logging session, a new lot is created.
- A complete set of GLP information including date, time, mode selection, temperature reading, and calibration information is stored with each log.

Manual logging

- Readings are logged each time log symbol (●) is tapped on display.
- All manual readings are stored in a single lot (i.e. records made on different days share the same lot).

Autohold logging

- Readings are logged each time log symbol (●) is tapped on display and configured stability criteria is reached.
- All Autohold readings are stored in a single lot (i.e. records made on different days are logged in the same lot).

Note: Stability criteria can be set to Fast, Medium, or Accurate for all logging types.

14.1. AUTOMATIC LOGGING

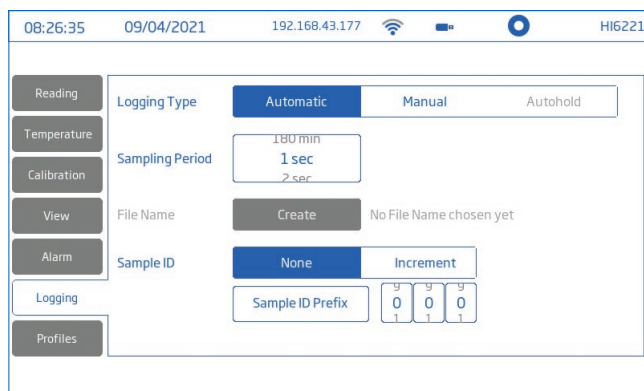

1. From Measurement screen, tap Measurement Menu icon (⚙).
2. Tap Reading tab and tap to select stability criteria (Accurate, Medium, or Fast).
3. Tap Logging tab and select Automatic logging type.
4. Scroll to select Sampling Period.
5. See option to define sample ID (name and prefix):

- Tap Sample ID Prefix field to start editing.
 - Use the on-screen keypad to enter lot file name.
 - Tap Enter on keypad to save new name.
 - Scroll to select Prefix value.
6. Tap **Home** key (○) on instrument, to reenter Measurement screen.
 7. From Measurement screen, tap ● symbol to start logging, and tap ● symbol to stop logging.
 8. During active logging, users can track and log notes.

To add a new log note:

 - Tap speech balloon symbol (☰) on display .
 - Use on-screen keypad to enter text.
 - Tap Enter on keypad to log entered note.

The View display shows a list of all stored log notes.

14.2. MANUAL LOGGING

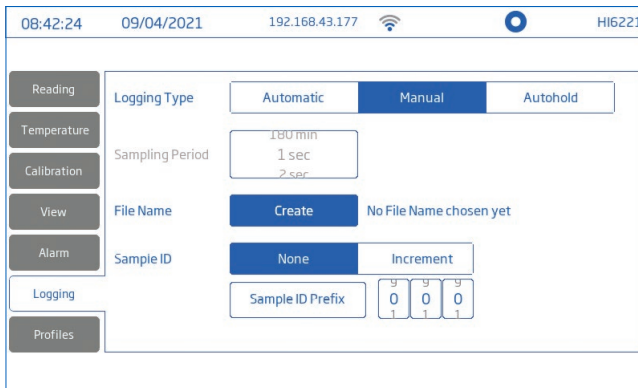

1. From Measurement screen, tap Measurement Menu icon (⚙️).
2. Tap Reading tab and tap to select stability criteria (Accurate, Medium, or Fast).

Note: Manual logging doesn't use this criteria for logging. Setting this is only for the user to note the stability of the reading.
3. Tap Logging tab and select Manual logging type.
4. See option to create file name:
 - Tap Create.
 - Use on-screen keypad to enter file name.
 - Tap Enter on keypad to save new name.
5. See option to define sample ID (name and prefix).

Follow Automatic Logging, step 4.

6. Tap **Home** key (○) on instrument, to return to Measurement screen.
7. From Measurement screen, tap manual logging symbol (●) to log data.
Data is logged every time symbol is tapped.
8. See option to track and log notes.
Follow Automatic Logging, step 7.

14.3. AUTOHOLD LOGGING

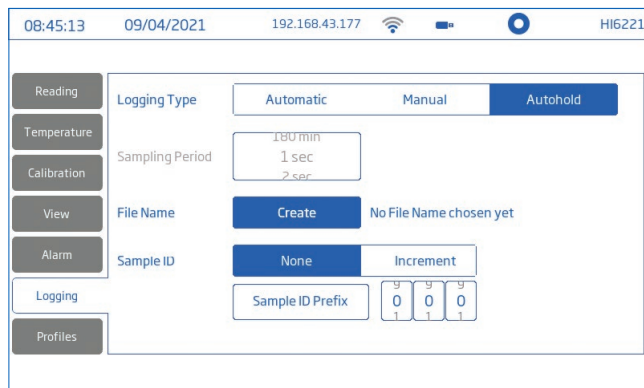

1. From Measurement screen, tap Measurement Menu icon (⚙).
2. Tap Reading tab to select stability criteria (Accurate, Medium, or Fast).
***Note:** Autohold logging uses this criteria for logging. Setting this will affect when data is recorded.*
3. Tap for direct selection of Direct/Autohold reading mode.
4. Tap Logging tab and select Autohold logging type
5. Ceate a file name or have a file previously set up
6. Option to define sample ID (name and prefix)
 - Tap Sample ID Prefix field to start editing.
 - Use the on-screen keypad to enter lot file name.
 - Tap Enter on keypad to save new name.
 - Next, scroll to select Prefix value.
7. Tap **Home** key (○) on instrument, to reenter Measurement screen.
8. From Measurement screen, tap Direct logging symbol (●) on display to start logging.
Active Autohold logging in progress is indicated by displayed ● symbol.
Progress bar, top left corner, indicates progress status.
9. Once configured stability criteria is checked, and conditions are met, data is logged.
The instrument prompts measurement screen, displayed in configured view.

Note: *.csv file format naming convention*

To help ensure that measurement-specific data files can be easily identified within a data package or after download, logged files have the measurement unit automatically included in the file name.

E.g. When reading and logging in pH Parameter, automatically logged files retain pH ID at the beginning of the file. For files logged with Manual or Autohold option, users can input file name, but the distinction between different reading modes (pH, mV, or Rel. mV) is retained in the name of the file.

15. MAINTENANCE & CONDITIONING

Electrode Maintenance

- Soak the pH bulb and reference junction in [HI70300](#) Storage Solution for a minimum of 1 hour before attempting.
- After prolonged storage or cleaning, calibration of the electrode.
- After use, rinse the electrode with purified water and blot excess moisture with a lint free tissue.
- Inspect all sensor connectors for corrosion and replace if necessary.

pH Sensor Maintenance

- Remove the sensor protective cap. Do not be alarmed if any salt deposits are present. This is normal with pH / ORP probes and they will disappear when rinsed with water.
- Shake down the probe as you would do with a clinical thermometer to eliminate any air bubbles inside the glass bulb.
- If the bulb and / or junction are dry, soak the electrode in [HI70300](#) Storage solution for at least 1 hour.
- To ensure a quick response, the glass bulb and the junction should be kept moist and not allowed to dry. This can be achieved by storing the sensor with a few drops of [HI70300](#) Storage solution or pH 4.01 in the protective cap.

Note: *Never use distilled or deionized water to store electrode.*

Periodic Maintenance

- Inspect the electrode for any scratches or cracks. If any are present, replace the electrode.
- Inspect the cable. The connection cable must be intact.
- Rinse off any salt deposits with water.

pH Cleaning Procedure

1. Soak the sensor in [HI7061](#) Electrode cleaning solution for general use or application specific cleaning solution for 15 minutes.
2. Rinse with water.
3. Soak the electrode in [HI70300](#) Storage solution for at least 30 minutes, rinse with water and calibrate before using.

Protein, Inorganic, Oil, or Grease Cleaning Procedure

1. Soak the sensor in application specific electrode cleaning solution (i.e. [HI7073](#) Protein cleaning, [HI7074](#) Inorganic cleaning for 15 minutes or [HI7077](#) Oil and Fat cleaning solution).
2. Rinse the sensor with water.

Note: *After performing any of the cleaning procedures, rinse the electrode thoroughly with water and soak in [HI70300](#) Storage solution for at least 30 minutes before calibrating it.*

3. Soak the electrode in [HI70300](#) Storage solution for at least 1 hour, rinse with water, and calibrate before using.

General cleaning of HI6221

The following steps outline the process to ensure users keep the benchtop clean and disinfected while limiting the risk of damage from unsuitable cleaners.

- Disinfect the screen using commercially available non-ammonia glass or disinfectant cleaner.
- Apply a small amount of cleaner directly to a microfibre or lint-free disposable cloth. Make sure the cloth is damp and not wet.
- Wipe the glass touch screen clean with the cloth. Do not apply cleaner directly to the interface.

16. ACCESSORIES

pH BUFFER CALIBRATION SOLUTIONS

HI6016	Buffer solution pH 1.679 (500 mL)
HI6003	Buffer solution pH 3.000 (500 mL)
HI6004	Buffer solution pH 4.010 (500 mL)
HI6068	Buffer solution pH 6.862 (500 mL)
HI6007	Buffer solution pH 7.010 (500 mL)
HI6010	Buffer solution pH 10.010 (500 mL)
HI6124	Buffer solution pH 12.450 (500 mL)
HI8004L	Buffer solution pH 4.01 (500 mL, FDA approved bottle)
HI8006L	Buffer solution pH 6.86 (500 mL, FDA approved bottle)
HI8007L	Buffer solution pH 7.01 (500 mL, FDA approved bottle)
HI8009L	Buffer solution pH 9.18 (500 mL, FDA approved bottle)
HI8010L	Buffer solution pH 10.01 (500 mL, FDA approved bottle)

ELECTRODE ELECTROLYTE REFILL SOLUTIONS

HI7071	3.5M KCl + AgCl Electrolyte for single junction electrodes, 4 pcs. (30 mL)
HI7072	1M KNO ₃ Electrolyte, 4 pcs. (30 mL)
HI7082	3.5M KCl Electrolyte for double junction electrodes, 4 pcs. (30 mL)
HI8071	3.5M KCl + AgCl Electrolyte in FDA approved bottle, for single junction electrodes, 4 pcs. (30 mL)
HI8072	1M KNO ₃ Electrolyte, 4 pcs. (30 mL, FDA approved bottle)
HI8082	3.5M KCl Electrolyte for double junction electrodes, 4 pcs. (30 mL, FDA approved bottle)
HI8093	1M KCl + AgCl Electrolyte, 4 pcs. (30 mL, FDA approved bottle)

ELECTRODE STORAGE SOLUTIONS

HI70300L	Storage solution (500 mL)
HI80300L	Storage solution (500 mL, FDA approved bottle)

ELECTRODE CLEANING SOLUTIONS

HI70000P	Electrode rinse sachet, 25 pcs. (20 mL)
HI7061L	General purpose solution (500 mL)
HI7073L	Protein cleaning solution (500 mL)
HI7074L	Inorganic substance cleaning solution (500 mL)
HI7077L	Oil and Fat cleaning solution (500 mL)
HI8061L	General purpose solution (500 mL, FDA approved bottle)
HI8073L	Protein cleaning solution (500 mL, FDA approved bottle)
HI8077L	Oil and fat cleaning solution (500 mL, FDA approved bottle)

OTHER ACCESSORIES

HI740036P	100 mL beaker (10 pcs.)
HI740037P	20 mL beaker (10 pcs.)
HI764060	Electrode holder
HI900946	115 Vac to 24 Vdc power adapter, US plug
HI900947	230 Vac to 24 Vdc power adapter, European plug
HI920016	USB type A to C cable

ELECTRODES

Electrode part numbers ending in B are supplied with a BNC connector and 1 m (3.3') cable.

pH

HI1043B

Glass body, double junction, refillable, combination electrode

Application: strong acid or alkali

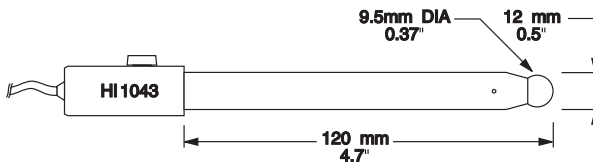

pH

HI1053B

Glass body, triple ceramic, conical shape, refillable, combination electrode
Ideally suited for emulsions.

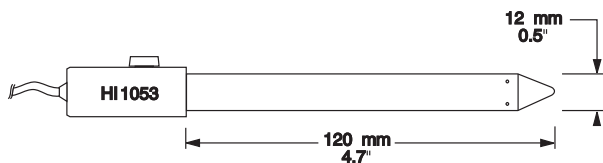
**HI1083B**

Glass body, micro, viscolene, non refillable, combination electrode
Application: biotechnology, micro titration

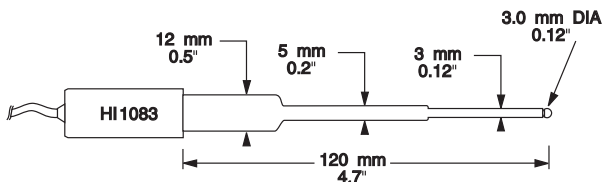
**HI1131B**

Glass body, refillable, double junction, combination electrode
Application: general purpose

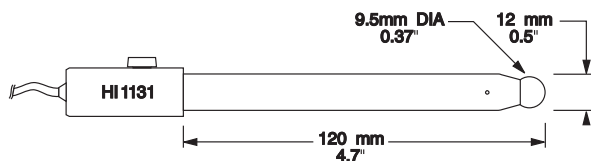

pH

HI1330B

Glass body, semimicro, single junction, refillable, combination electrode

Application: laboratory, vials

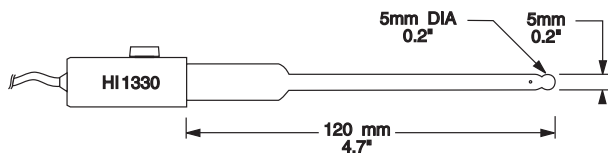

HI1331B

Glass body, semimicro, single junction, refillable, combination electrode

Ideally suited for flasks.

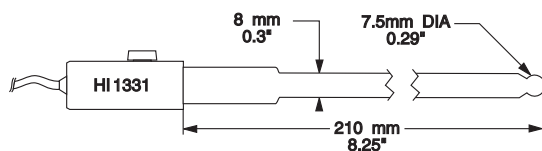

HI1230B

Plastic body (PEI), double junction, gel filled, combination electrode

Application: general, field

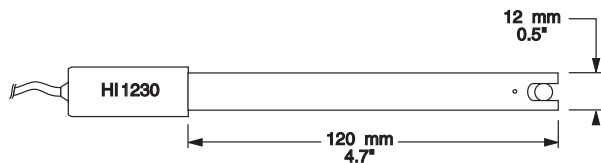

pH

HI2031B

Glass body, semimicro, conical, single junction, refillable, combination electrode

Application: semisolids

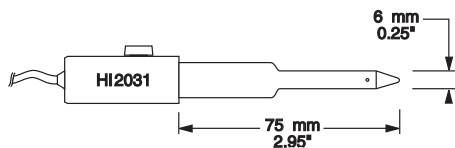
**HI1332B**

Plastic body (PEI), double junction, refillable, combination electrode

Application: general purpose

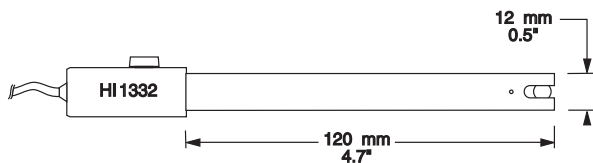
**HI1413B**

Glass body, single junction, flat tip, viscolene, non refillable, combination electrode

Application: surface measurement

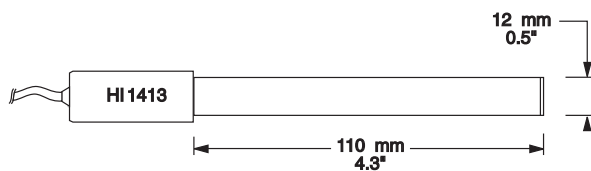
**FC100B**

Plastic body (PVDF), double junction, refillable, combination electrode

Application: general purpose for food industry

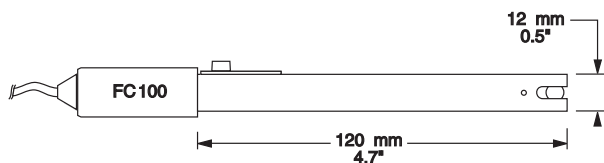

pH

FC200B

Plastic body (PVDF), single junction, conical, viscolene, non refillable, combination electrode

Application: meat and cheese

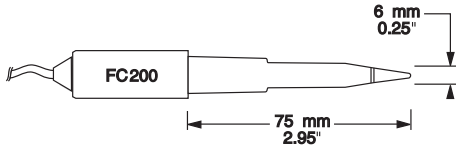
**FC210B**

Glass body, double junction, conical, viscolene, non refillable, combination electrode

Application: milk and yogurt

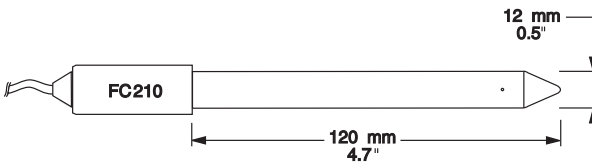
**FC220B**

Glass body, triple ceramic, single junction, refillable, combination electrode

Application: food processing

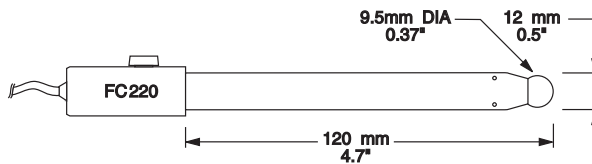
**FC911B**

Plastic body (PVDF), double junction, refillable with built-in amplifier, combination electrode

Ideally suited for very high humidity.

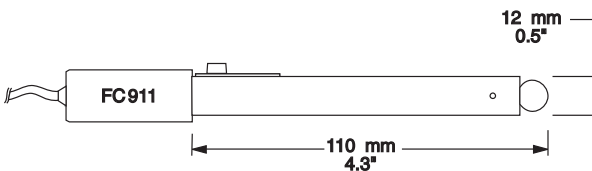

ORP

HI3131B

Glass body, refillable, combination platinum electrode

Application: titration

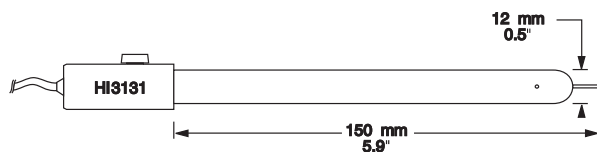

HI3230B

Plastic body (PEI), gel filled, combination platinum electrode

Application: general purpose

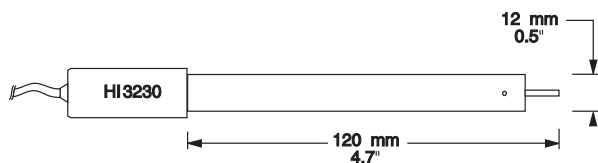

HI4430B

Plastic body (PEI), gel filled, combination gold electrode

Application: general purpose

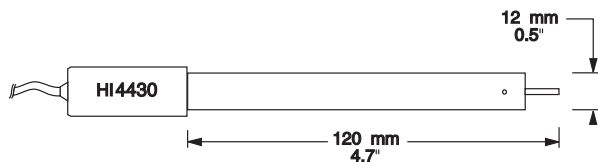

Extension cables for screw-type electrodes (screw to BNC adapter)

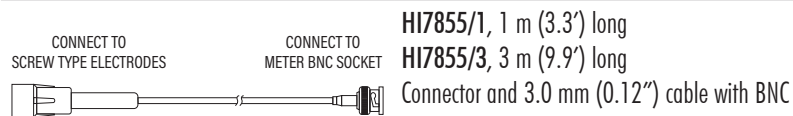

Please refer to the Hanna Instruments general catalog for more electrodes with screw-type or BNC connectors.

CERTIFICATION

All Hanna Instruments conform to the **CE European Directives**.



Disposal of Electrical & Electronic Equipment. The product should not be treated as household waste. Instead hand it over to the appropriate collection point for the recycling of electrical and electronic equipment which will conserve natural resources.

Ensuring proper product disposal prevents potential negative consequences for the environment and human health. For more information, contact your city, your local household waste disposal service, or the place of purchase.



RECOMMENDATIONS FOR USERS

Before using this product, make sure it is entirely suitable for your specific application and for the environment in which it is used. Any variation introduced by the user to the supplied equipment may degrade the meter's performance. For yours and the meter's safety do not use or store the meter in hazardous environments.

WARRANTY

6221 is warranted for two years against defects in workmanship and materials when used for its intended purpose and maintained according to instructions. Electrodes and probes are warranted for a period of six months. This warranty is limited to repair or replacement free of charge. Damage due to accidents, misuse, tampering or lack of prescribed maintenance is not covered.

If service is required, contact your local Hanna Instruments office. If under warranty, report the model number, date of purchase, serial number (see engraved on the back of the meter) and the nature of the problem. If the repair is not covered by the warranty, you will be notified of the charges incurred. If the meter is to be returned to Hanna Instruments, first obtain a Returned Goods Authorization number from the Technical Service department and then send it with shipping costs prepaid. When shipping any meter, make sure it is properly packed for complete protection.

REGULATORY NOTICES FOR THE WI-FI MODULE

United States (FCC) FCC ID: 2ADHKATWINC1500.

This device complies with Part 15 of the FCC Rules. Operation is subject to the following two conditions: (1) this device may not cause harmful interference, and (2) this device must accept any interference received, including interference that may cause undesired operation.

Canada (ISED) IC: 20266-WINC1500PB

HVIN: ATWINC1500-MR210PB

PMN: ATWINC1500-MR210PB

This device complies with Industry Canada's license exempt RSS standard(s). Operation is subject to the following two conditions: (1) This device may not cause interference, and (2) This device must accept any interference, including interference that may cause undesired operation of the device. Le présent appareil est conforme aux CNR d'Industrie Canada applicables aux appareils radio exempts de licence. L'exploitation est autorisée aux deux conditions suivantes: (1) l'appareil ne doit pas produire de brouillage, et (2) l'utilisateur de l'appareil doit accepter tout brouillage radioélectrique subi, même si le brouillage est susceptible d'en compromettre le fonctionnement.

Under Industry Canada regulations, this radio transmitter may only operate using an antenna of a type and maximum (or lesser) gain approved for the transmitter by Industry Canada. To reduce potential radio interference to other users, the antenna type and its gain should be so chosen that the equivalent isotropically radiated power (e.i.r.p.) is not more than that necessary for successful communication. Conformément à la réglementation d'Industrie Canada, le présent émetteur radio peut fonctionner avec une antenne d'un type et d'un gain maximal (ou inférieur) approuvé pour l'émetteur par Industrie Canada. Dans le but de réduire les risques de brouillage radioélectrique à l'intention des autres utilisateurs, il faut choisir le type d'antenne et son gain de sorte que la puissance isotrope rayonnée équivalente (p.i.r.e.) ne dépasse pas l'intensité nécessaire à l'établissement d'une communication satisfaisante.

Japan (MIC) 005-101762

South Korea (KCC) R-CRM-mcp-WINC1510MR210P

Taiwan (NCC) CCAN18LP0321T2

注意！依據 低功率電波輻射性電機管理辦法 第十二條 經型式認證合格之低功率射頻電機，非經許可，公司、商號或使用者均不得擅自變更頻率、加大功率或變更原設計之特性及功能。第十四條 低功率射頻電機之使用不得影響飛航安全及干擾合法通信；經發現有干擾現象時，應立即停用，並改善至無干擾時方得繼續使用。前項合法通信，指依電信規定作業之無線電信。低功率射頻電機須忍受合法通信或工業、科學及醫療用 電波輻射性 電機設備之干擾。

China (SRRC) CMIIT ID: 2018DJ1305

ANATEL 08497-18-08759

Note: FCC information is marked on the back of the device.





Hanna Instruments reserves the right to modify the design, construction or appearance of its products without advance notice.

World Headquarters

Hanna Instruments Inc.
Highland Industrial Park
584 Park East Drive
Woonsocket, RI 02895 USA
www.hannainst.com



MAN6221

Printed in ROMANIA