

Field Network Controllers

ROBO Cylinder Position Controller
PowerCON 150

ROBO Cylinder Position Controller
High-thrust Motor Type

PCON-CA

PCON-CFA

PCON-CA
PCON-CFA



PCON Controllers Now Support Field Networks

1 Supporting seven major field networks









DeviceNet, CC-Link, PROFIBUS-DP, CompoNet, MECHATROLINK (I, II), EtherCAT and EtherNet/IP are supported. Key features include wire-saving, direct numerical specification, position number specification, and current position read.

2 PCON-CFA for high-thrust motors









	Supported actuators
PCON-CA	ROBO Cylinder RCP4 / RCP3 / RCP2 series
PCON-CFA	ROBO Cylinder RCP2-RA8C / RA8R / RA10C / HS8C / HS8R series ROBO Cylinder splash-proof RCP2W-SA16C / RA10C series

List of Models

ROBO Cylinder Position Controller PowerCON 150 <PCON-CA>

External view										
I/O type		Positioner type	Pulse-train type	Field network type						
										
				DeviceNet connection specification	CC-Link connection specification	PROFIBUS-DP connection specification	CompoNet connection specification	MECHATROLINK connection specification	EtherCAT connection specification	EtherNet/IP connection specification
I/O type model code		NP/PN	PLN/PLP	DV	CC	PR	CN	ML	EC	EP
Standard price	Incremental specification	-	-	-	-	-	-	-	-	-
	Simple absolute specification	With absolute battery	-	-	-	-	-	-	-	-
		With absolute battery unit	-	-	-	-	-	-	-	-
		No absolute battery	-	-	-	-	-	-	-	-

ROBO Cylinder Position Controller High-thrust Motor Type <PCON-CFA>

External view										
I/O type		Positioner type	Pulse-train type	Field network type						
										
				DeviceNet connection specification	CC-Link connection specification	PROFIBUS-DP connection specification	CompoNet connection specification	MECHATROLINK connection specification	EtherCAT connection specification	EtherNet/IP connection specification
I/O type model code		NP/PN	PLN/PLP	DV	CC	PR	CN	ML	EC	EP
Standard price	Incremental specification	-	-	-	-	-	-	-	-	-

Model Number

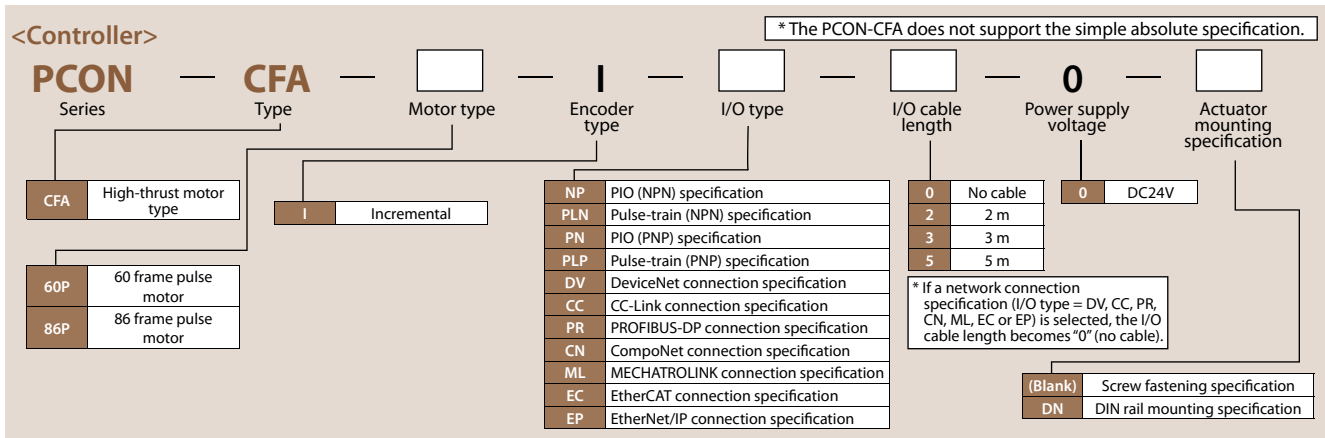
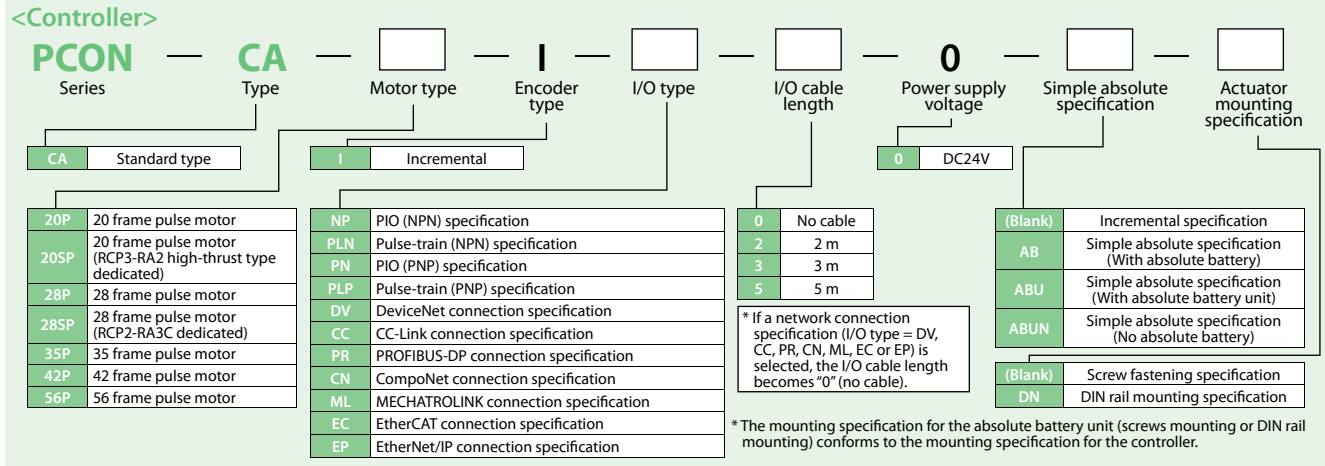

Specification Table

Item	Description		
	PCON-CA	PCON-CFA	
Number of controlled axes	1 axis		
Power supply voltage	24 VDC ± 10%		
Load capacity (Current consumption of controlled axes included) (Note 1)	RCP2	20P, 28P, 28SP	1A max.
	RCP3	42P, 56P	2.2A max.
		60P, 86P	6A max.
RCP4	42P, 56P	High-output setting disabled: 2.2 A max. High-output setting enabled: 3.5 A rated / 4.2 A max.	
Power supply for electromagnetic brake (for actuators with brake)	24 VDC ± 10%, 0.15 A (max.)		
Rush current (Note 2)	8.3 A	10 A	
Momentary power failure resistance	500 μs max.		
Applicable encoder	Incremental encoder of 800 pulses/rev in resolution		
Actuator cable length	20 m max.		
External interface	PIO specification	Dedicated 24-VDC signal input/output (NPN or PNP selected) --- Up to 16 input points, up to 16 output points / Cable length: 10m max.	
	Field network specification	DeviceNet, CC-Link, PROFIBUS, CompoNET, MECHATROLINK, EtherCAT, EtherNet/IP	
Data setting/input method	PC software, touch-panel teaching pendant		
Data retention memory	Position data and parameters are saved in the non-volatile memory (The memory can be written any number of times.)		
Operation modes	Positioner mode / Pulse-train control mode (Selectable by parameter setting)		
Number of positions in positioner mode	Up to 512 points for the positioner type, up to 768 points for the network type (Note) The number of positioning points varies depending on the PIO pattern selected.		
Pulse-train interface	Input pulse	Differential method (line driver method): 200 kpps max. / Cable length: 10 m max. Open collector method: Not supported * If the host uses open-collector output, convert the open-collector pulses to differential pulses using the AK-04 (available as an option).	
	Command pulse magnification (electronic gear ratio: A/B)	1/50 < A/B < 50/1 Setting range of A and B (set by parameters): 1 to 4096	
	Feedback pulse output	None	
Isolation resistance	500-VDC 100 MΩ or more		
Electric shock protection mechanism	Class I basic isolation		
Mass (Note 3)	Incremental specification	Screw fastening type: 250 g or less DIN rail securing type: 285 g or less	
	Simple absolute specification (190 g of battery weight included)	Screw fastening type: 450 g or less DIN rail securing type: 485 g or less	
Cooling method	Natural air cooling	Forced air cooling	
Environment	Ambient operating temperature	0 to 40°C	
	Ambient operating humidity	85%RH or less (non-condensing)	
	Operating ambience	Not exposed to corrosive gases	
	Protection degree	IP20	

Note 1) The value increases by 0.3 A for the field network specification.

Note 2) After the power is turned on, rush current will flow for approx. 5 msec (at 40°C). Take note that the rush current varies depending on the impedance of the power-supply line.

Note 3) The value increases by 30 g for the field network specification.

External Dimensions

<PCON-CA>

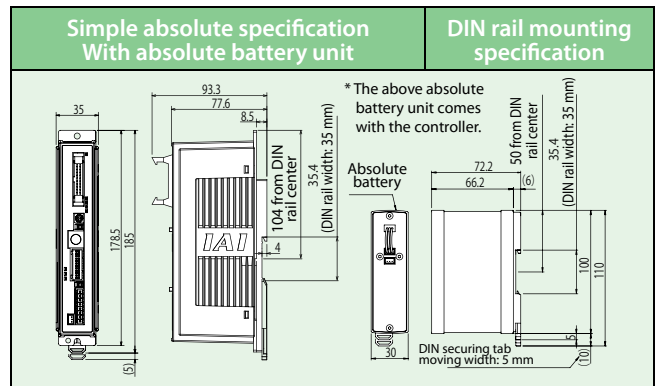
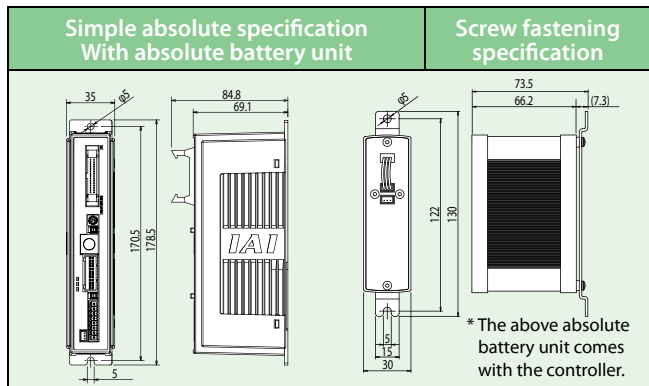
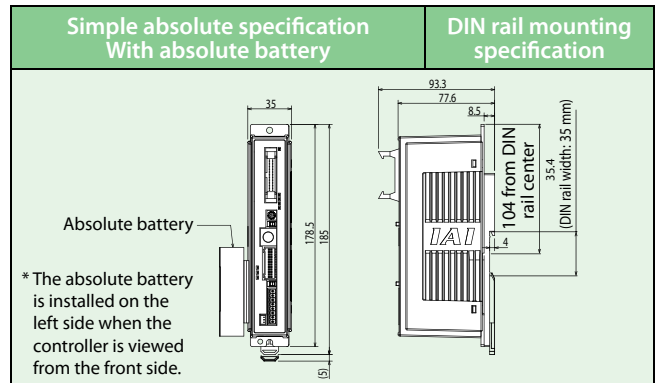
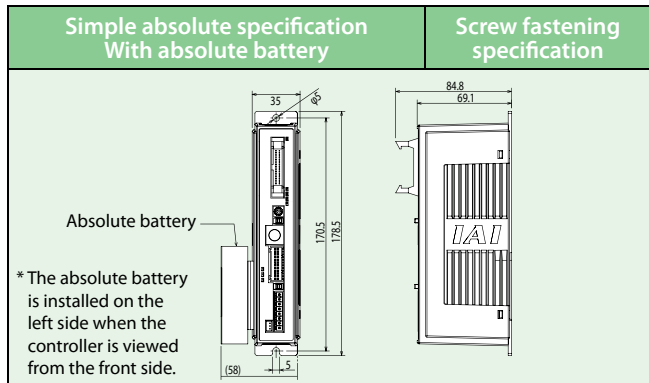
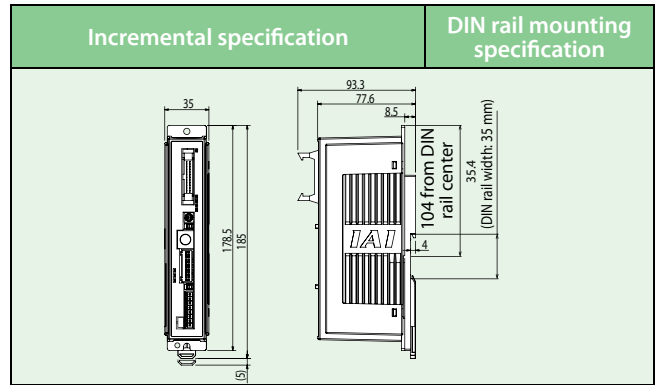
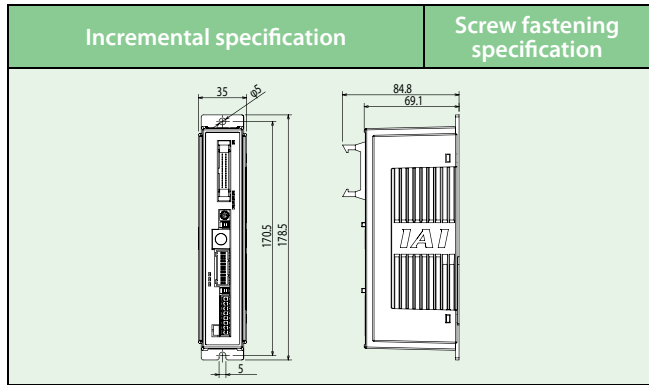

<PCON-CFA>

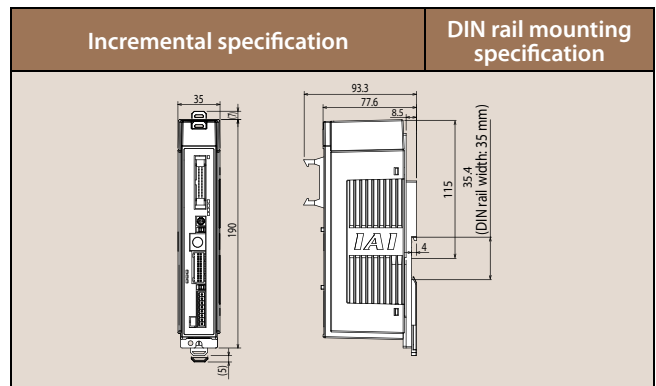
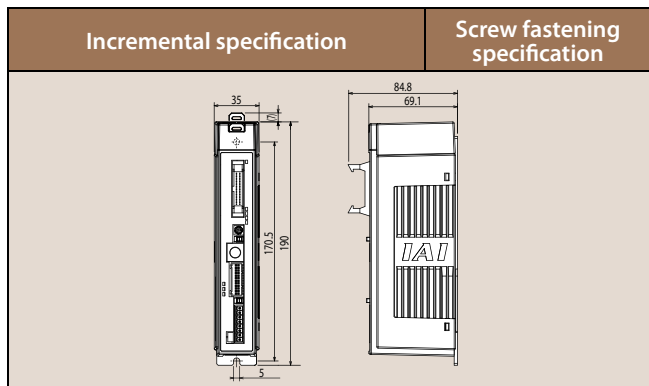

IAI America, Inc.

Headquarters: 2690 W. 237th Street Torrance, CA 90505 (800) 736-1712
 Chicago Office: 1261 Hamilton Parkway Itasca, IL 60143 (800) 944-0333
 Atlanta Office: 1220 Kennestone Circle, Suite 108, Marietta, GA 30066 (888) 354-9470

The information contained in this product brochure may change without prior notice due to product improvements.

IAI Industrieroboter GmbH

Ober der Roth 4, D-65824 Schwalbach am Taunus, Germany

www.intelligentactuator.com

