

# HF9516

## 1 CUBIC INCH 3 FORM C HERMETICALLY SEALED RELAY WITH COIL TRANSIENT SUPPRESSION



### Features

- Force balanced type
- With coil transient suppression
- 25A contacts switching capability
- Failure rate can be level L
- High ambient applicability
- All metal welded construction
- Hermetically welded and marked by laser

Conform to GJB2888-97 (Equivalent to MIL-PRF-83536)

### AMBIENT ADAPTABILITY

Ambient grade		I	II	III
Ambient temperature		-55 °C to 85 °C	-55 °C to 85 °C	-65 °C to 125 °C
Humidity		98%, 40 °C		
Low air pressure		58.53 kPa	4.39 kPa	4.39 kPa
Sine vibration	Frequency	10 Hz to 1000 Hz	10 Hz to 2000 Hz	10 Hz to 3000 Hz
	Acceleration	147 m/s <sup>2</sup>	196 m/s <sup>2</sup>	294 m/s <sup>2</sup>
Shock resistance		490 m/s <sup>2</sup>	980 m/s <sup>2</sup>	1960 m/s <sup>2</sup>
Random vibration		—	20 (m/s <sup>2</sup> )/Hz	40 (m/s <sup>2</sup> )/Hz
Steady-state acceleration		147 m/s <sup>2</sup>	294 m/s <sup>2</sup>	490 m/s <sup>2</sup>

### CONTACT DATA

Ambient grade		I	II	III
Arrangement		3 C		
Contact resistance or voltage drop	Initial max.	0.01 Ω		0.006 Ω
	After life max.	0.012 Ω		0.007 Ω

### Contact and life ratings

Type	Contact load		Electrical life min.
	28Vd.c.	115/200Va.c. 400Hz Three phase	
Resistive	25A	25A	5 x 10 <sup>4</sup> ops
Inductive	12A	—	1 x 10 <sup>4</sup> ops
Inductive	—	15A	2 x 10 <sup>4</sup> ops
Motor	10A	—	5 x 10 <sup>4</sup> ops
Lamp load	5A	—	5 x 10 <sup>4</sup> ops



HONGFA HERMETICALLY SEALED RELAY

## SPECIFICATION

Ambient grade		I	II	III
Insulation resistance min.	Initial	100 MΩ (@ 500 Vd.c.)	100 MΩ (@ 500 Vd.c.)	100 MΩ (@ 500 Vd.c.)
	After life or after testing	50 MΩ (@ 500 Vd.c.)	50 MΩ (@ 500 Vd.c.)	50 MΩ (@ 500 Vd.c.)
Dielectric strength min. (Normal condition)	Between coil & cover	1000 Vr.m.s.	1000 Vr.m.s.	1000 Vr.m.s.
	Between other insulation parts (initial)	1250 Vr.m.s.	1250 Vr.m.s.	1250 Vr.m.s.
	Between other insulation parts (after life testing)	1000 Vr.m.s.	1000 Vr.m.s.	1000 Vr.m.s.
Dielectric strength min. (Low air pressure condition)		250 Vr.m.s.	250 Vr.m.s.	350 Vr.m.s.
Leakage rate max.		1 Pa·cm <sup>3</sup> /s	1 x 10 <sup>-1</sup> Pa·cm <sup>3</sup> /s	1 x 10 <sup>-3</sup> Pa·cm <sup>3</sup> /s
Operate time max.				15 ms
Release time max.				15 ms
Mounting style				See the mounting dimension
Terminals				See the terminal styles
Work position				Random
Weight max.				85 g

## COIL DATA

Normal coil power	Approx.3W
-------------------	-----------

### Coil Version

Order Number	Coil voltage		at 25 °C				-65°C to 125°C			Pick-up voltage max.	
	Nominal voltage	Value max.	Coil resistance (Ω) min.	Pick-up voltage max.	Hold voltage max.	Drop-out voltage min.	Pick-up voltage max.	Hold voltage max.	Drop-out voltage min.	High temp. test	Continuous electric test
028	28	29	260	15.5	5.5	2.3	20.0	7.0	1.5	21.0	25.0

Notes: We can offer many kinds of coil voltage under the requirement of users.

## ORDERING INFORMATION

Type	HF9516	-028	L	-2	2	- II
Order Number	028					
Failure Rate	L: Failure rate level L (level III products available) <sup>1)</sup> Nil: Without failure rate requirement(level I ,II ,IIIproducts available)					
Mounting Style	2, 3 (See the mounting dimension)					
Terminals Style	2, 4 (See " Terminal styles " below)					
Ambient Grade	I : level I II : level II III: level III					

Notes: 1) For the failure rate of L ,the letter "III" of ambient grade level will not appear on relay cover.

# OUTLINE DIMENSIONS AND WIRING DIAGRAM

Unit:mm

## Outline Dimension

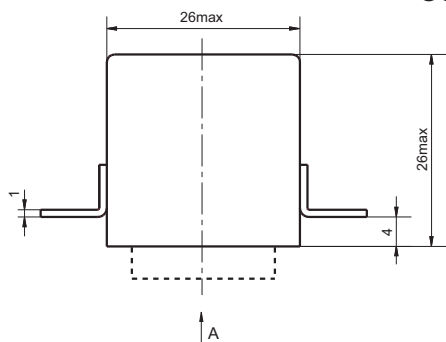

A direction

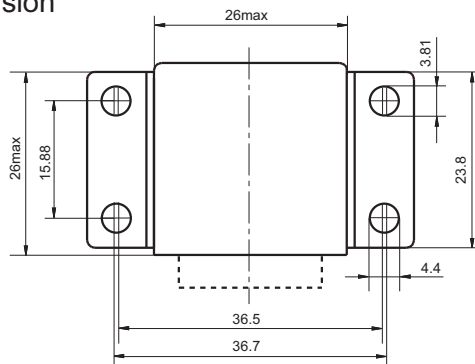

A direction

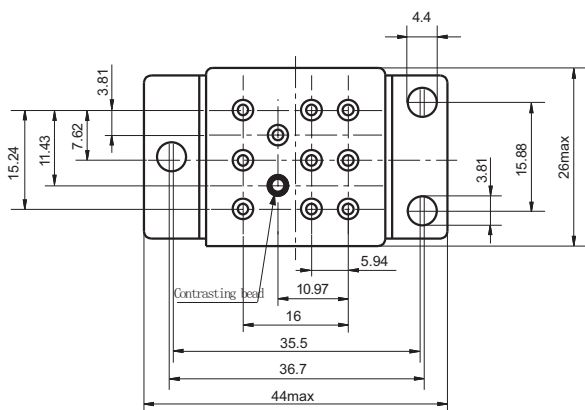

Mouting style 2

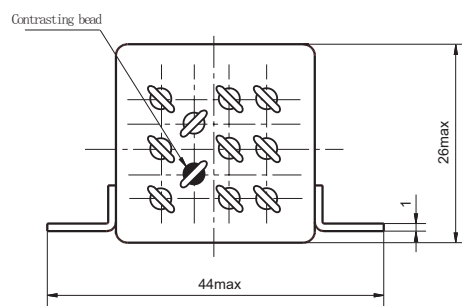

Mouting style 3

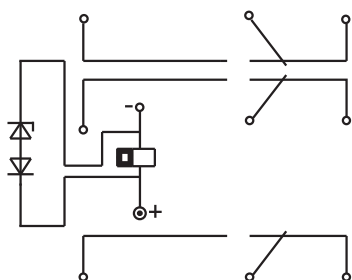

Wiring Diagram  
(Bottom View)

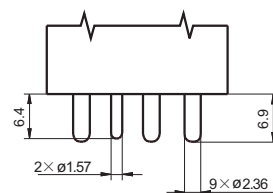

Terminal style 2  
(Solder pin)

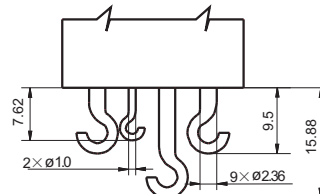

Terminal style 4  
(Solder hook)

### Disclaimer

This datasheet is for the customers' reference. All the specifications are subject to change without notice.

© Xiamen Hongfa Hermetically Sealed Relays Co., Ltd. All rights of Hongfa are reserved.