

HF116F-G

SOLAR RELAY



File No.:E134517



File No.:R50154722



Features

- 50A switching capability
- Applicable to inverter used for photovoltaic power generation systems
- 4kV dielectric strength(between coil and contacts)
- 3mm contact gap
(compliant to European Photovoltaic Standard VDE0126, compliant to IEC 62109-2-2011)
- 1A and 2A configuration available
- UL insulation system: Class F
- Environmental friendly product (RoHS compliant)
- Outline Dimensions: G1:(50.5 x 32.9 x 36.0) mm
G2:(51.5 x 34.9 x 36.0) mm
G3:(51.5 x 34.9 x 36.0) mm

CONTACT DATA

Contact arrangement	1A, 2A
Contact resistance	10mΩ max.(at 10A 13.5VDC)
Contact material	AgSnO ₂ , AgNi
Contact rating (Res. load)	50A 277VAC
Max. switching voltage	277VAC
Max. switching current	55A
Max. switching power	15235VA
Mechanical endurance	1 x 10 ⁶ OPS
Electrical endurance	3 x 10 ⁴ OPS (50A 277VAC, at room temp. 1s on 9s off)

COIL

Coil power	Approx. 3.2W
Holding voltage	60%~120%U _N (at 23°C) 70%~95%U _N (at 85°C)

- Notes:** 1)The coil holding voltage is the voltage applied to coil 200ms after the rated voltage.
2)To avoid overheating and burning, the coil can not be consistently applied to with voltage larger than maximum holding voltage.

CHARACTERISTICS

Insulation resistance	1000MΩ (at 500VDC)	
Dielectric strength	Between open contacts	2000VAC 1min
	Between coil & contacts	4000VAC 1min
	Between contact sets	2000VAC 1min
Surge Voltage	6kV (1.2/50μs)	
Operate time (at nomi. volt.)	30ms max.	
Release time (at nomi. volt.)	30ms max.	
Shock resistance	Functional	98m/s ²
	Destructive	980m/s ²
Vibration resistance*	Functional	10Hz to 55Hz 1.5mm DA
	Destructive	10Hz to 55Hz 1.5mm DA
Humidity	5% to 85% RH	
Ambient temperature	-40°C to 85°C	
Termination ²⁾	PCB	
Unit weight	Approx. 120g	
Construction	G1: Dust protected; G2, G3: Flux proofed	

- Notes:** 1) The data shown above are initial values.
2) It does not allow using quick-connect terminations.
3)*Index is not in relay width direction.

COIL DATA

at 23°C

Nominal Voltage VDC	Pick-up Voltage VDC max.	Drop-out Voltage VDC min.	Max. Voltage VDC *	Coil Resistance Ω
3	2.25	0.3	3.3	2.8 x (1±10%)
6	4.50	0.6	6.6	11.3 x (1±10%)
9	6.75	0.9	9.9	25 x (1±10%)
12	9.00	1.2	13.2	45 x (1±10%)
24	18.0	2.4	26.4	180 x (1±10%)
48	36.0	4.8	52.8	720 x (1±10%)

- Notes:** *Maximun voltage refers to the maximun voltage which relay coil could endure in a short period of time.



HONGFA RELAY

ISO9001, ISO/TS16949, ISO14001, OHSAS18001, IECQ QC 080000 CERTIFIED

2017 Rev. 1.10

ORDERING INFORMATION

HF116F-G1/		12	-1H	T	F	(XXX)
Type	G1: Type 1 G2: Type 2 G3: Type 3					
Coil voltage	3, 6, 9, 12, 24, 48VDC					
Contact arrangement	1H: 1 Form A 2H: 2 Form A					
Contact material	T: AgSnO ₂ Nil: AgNi					
Insulation standard	F: Class F					
Special code¹⁾	XXX: Customer special requirement		Nil: Standard			

Notes: 1) The customer special requirement express as special code after evaluating by Hongfa.

OUTLINE DIMENSIONS, WIRING DIAGRAM AND PC BOARD LAYOUT

Unit: mm

Outline Dimensions

PCB Layout
(Bottom view)

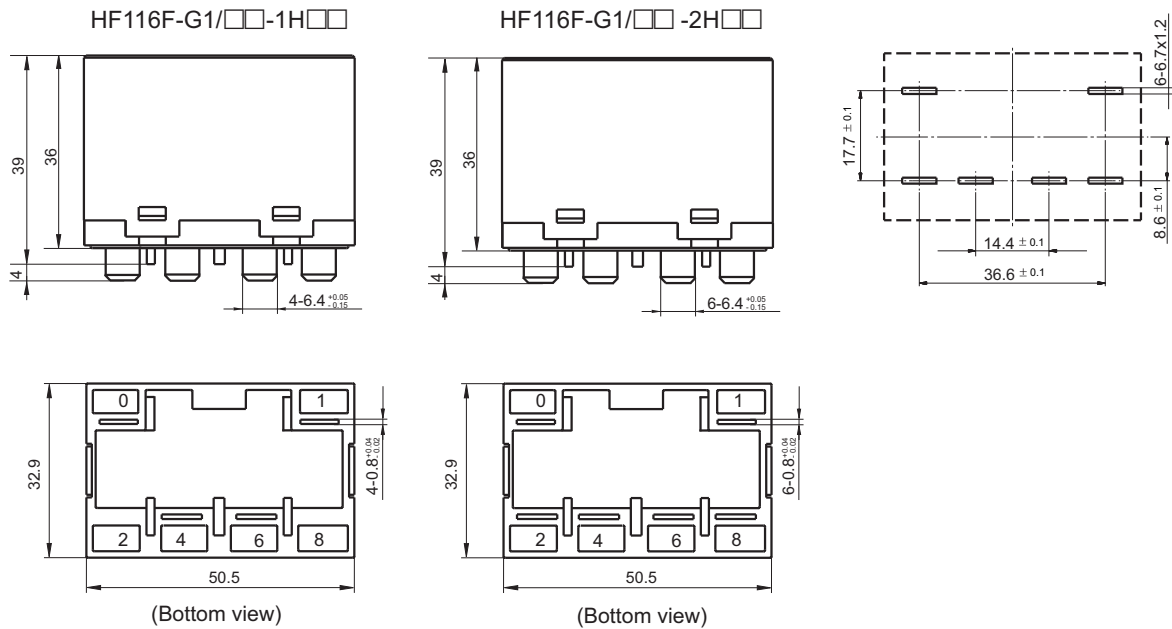

OUTLINE DIMENSIONS, WIRING DIAGRAM AND PC BOARD LAYOUT

Unit: mm

Outline Dimensions

HF116F-G2/□□ -1H□□

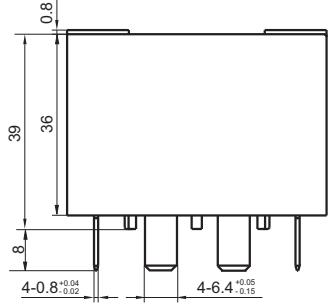

HF116F-G2/□□ -2H□□

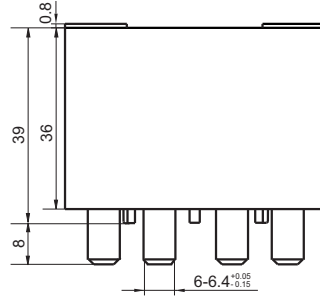

PCB Layout

(Bottom view)

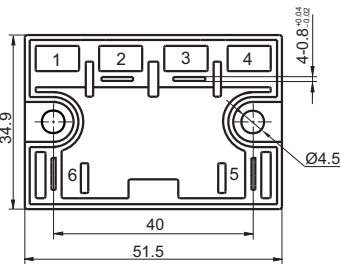
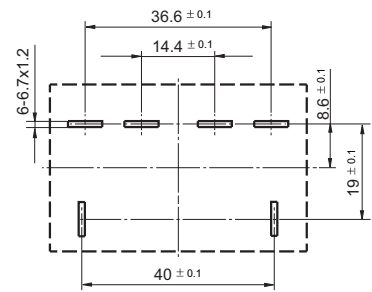

(Bottom view)

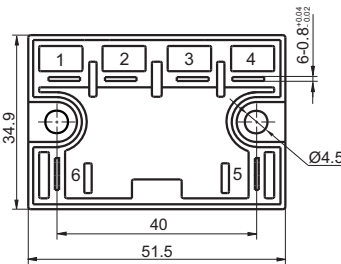

(Bottom view)

Outline Dimensions

HF116F-G3/□□ -1H□□

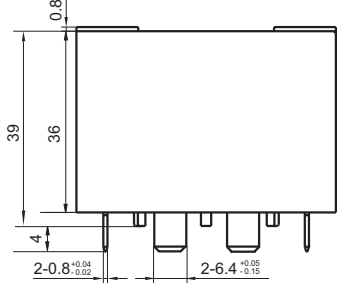

HF116F-G3/□□ -2H□□

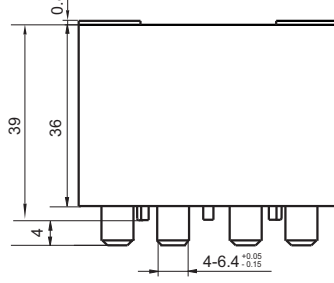

HF116F-G3

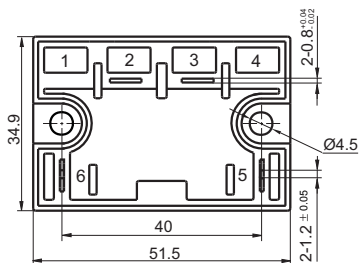
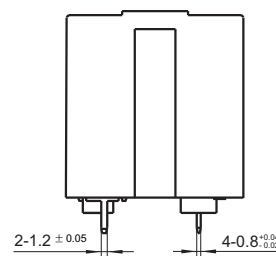

(Bottom view)

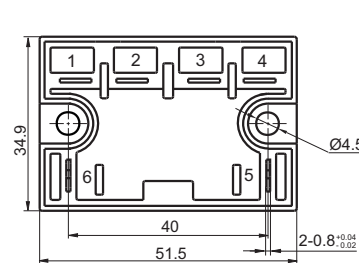

(Bottom view)

PCB Layout (Bottom view)

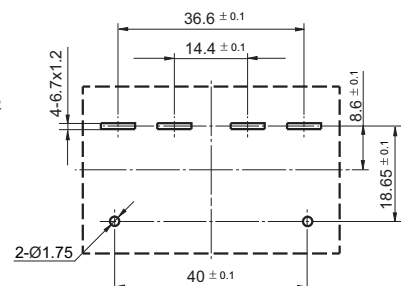

- Remark: 1) In case of no tolerance shown in outline dimension: outline dimension ≤ 1 mm, tolerance should be ± 0.2 mm; outline dimension > 1 mm and ≤ 5 mm, tolerance should be ± 0.3 mm; outline dimension > 5 mm, tolerance should be ± 0.4 mm.
 2) The tolerance without indicating for PCB layout is always ± 0.1 mm.

Wiring Diagram
(Bottom View)

G1 Type

1 Form A

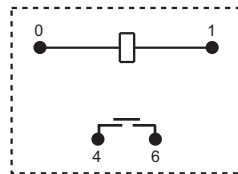

2 Form A

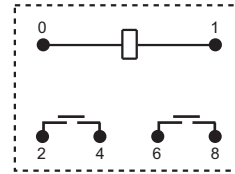

G2, G3 Type

1 Form A

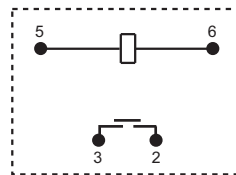

2 Form A

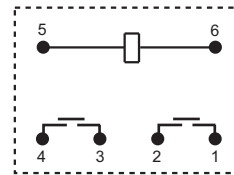

Disclaimer

The specification is for reference only. See to "Terminology and Guidelines" for more information. Specifications subject to change without notice. We could not evaluate all the performance and all the parameters for every possible application. Thus the user should be in a right position to choose the suitable product for their own application. If there is any query, please contact Hongfa for the technical service. However, it is the user's responsibility to determine which product should be used only.