

REVISION RECORD			
REV	ECN	DESCRIPTION	DRFT DATE

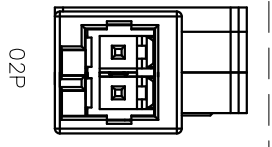
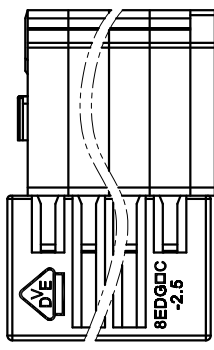
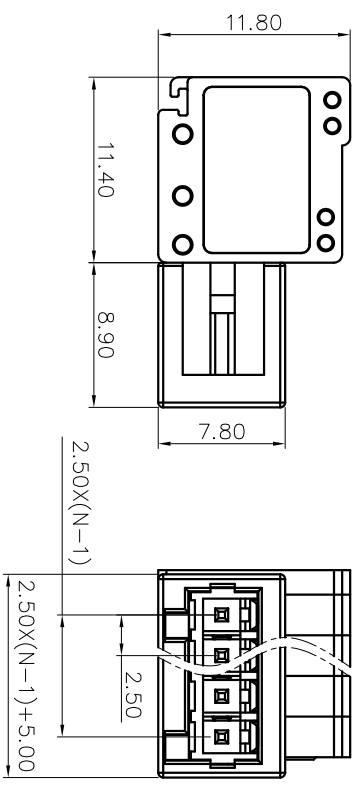
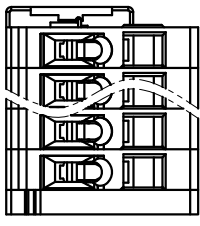
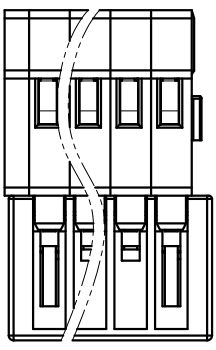
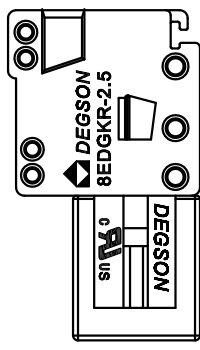

NOTES1:

- UL Standard
- 1. Rated Voltage/Current : 150V / 4A
- 2. Withstanding Voltage : AC1300V/1Min.
- 3. Wire Range : 28~20AWG
- IEC Standard

1. Pollution Degree	3
Overvoltage Category	III
Rate Impulse Voltage(KV)	2.5KV
Rate Voltage(V)	130V
Rate Current(A)	6A

2. Wire Range : 0.2~0.5mm²

NOTES2:

- 1. Dimension shall be interpreted per ASME Y14.5-2009
- 2. Pitch : 2.50mm, Poles : N=02~12P
- 3. Stripping length : 6~7mm
- 4. Operating temperature: -40°C~+105°C
- 5. Undimensioned Tolerances:

Pitch	Over	Over	Over	Over	Over	Over	Over
mm	mm	mm	mm	mm	mm	mm	mm
TO	6	10	30	60	100	150	0.1/10
6	10	24	30	60	100	150	≤
±0.15	±0.20	±0.30	±0.30	±0.50	±0.70	±1.00	±1.30
±2	±2	±2	±2	±2	±2	±2	±2

6. RoHS Compliance

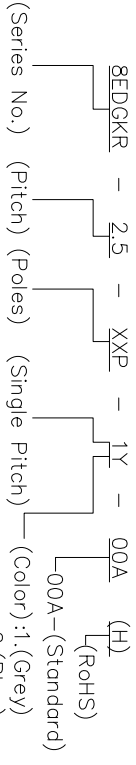

- (Series No.) (Pitch) (Poles) (Single Pitch) (Color):
- 1. (Grey)
- 2. (Blue)
- 3. (Black)
- 4. (Green)
- 5. (Orange)
- 6. (Red)
- 7. (Transparent)
- 8. (Yellow)
- 9. (White)

DETACHED LISTS	
PART NO.:	/
APPD:	/
CHKD:	/
DRFT:	/
THIRD ANGLE PROJECTION	
NAME:	DEGSON NINGBO DEGSON ELECTRICAL CO., LTD 宁波高松电子有限公司
TITLE:	CUSTOMER DRAWING
DRAWING NO.:	/
REV	DO
SHEET	1/1
SCALE	1:1