

REVISION RECORD

REV	ECN	DESCRIPTION	DRFT	DATE
-----	-----	-------------	------	------

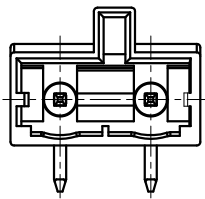

02P

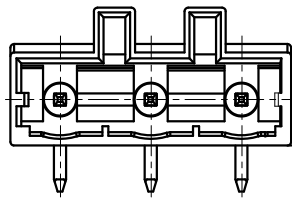

03P

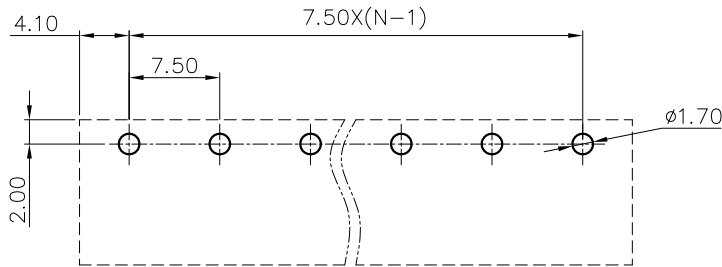
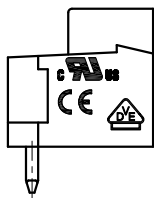
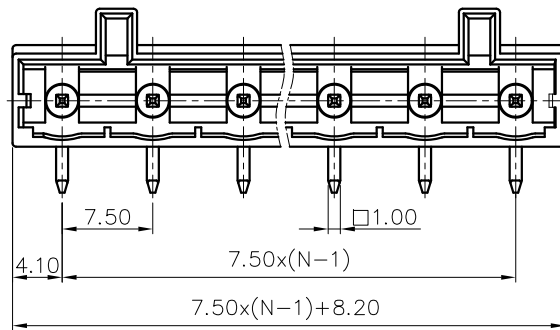
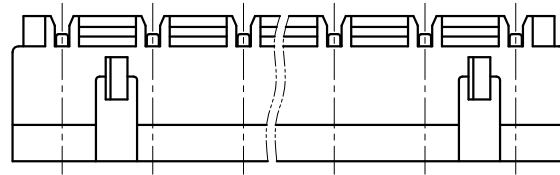

PCB LAYOUT

NOTES1:

UL Standard

1. Rated voltage/current : 300V / 15A
2. Withstanding voltage : AC1600V/1Min.

IEC Standard

1. Pollution Degree	3
Overvoltage Category	III
Rate Impulse Voltage(KV)	4.0KV
Rate Voltage(V)	400V
Rate Current(A)	20A

NOTES2:

1. Dimension shall be interpreted per ASME Y14.5-2009
2. Pitch : 7.50mm, Poles : N=02~12P
3. Operating temperature: -40°C~+105°C
4. Undimensioned tolerances:

Pitch range in mm		Nominal dimension range in mm					
TO 6	Over 6 TO 10	Over 10 TO 24	Over 30 TO 60	Over 60 TO 100	Over 100 TO 150	Over 150	0.1/10 ±2'
±0.15	±0.20	±0.30	±0.30	±0.50	±0.70	±1.00	±1.30

5. RoHS Compliance

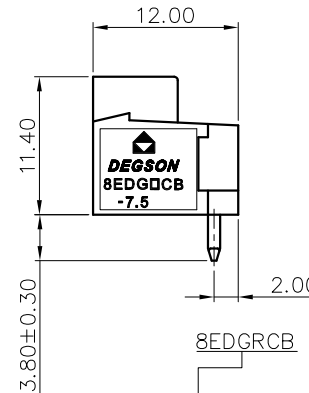

8EDGRCB - 7.5 - XXP - 1Y - 00A (H)
 (Series No.) (Pitch) (Poles) (Single Pitch) (Color): 1.(Grey)
 (RoHS)
 00A-(Standard)
 2.(Blue)
 3.(Black)
 4.(Green)
 5.(Orange)
 6.(Red)
 7.(Transparent)
 8.(Yellow)
 9.(White)

DETACHED LISTS	PART NO.:	/			
	APPD:	/			
	CHKD:	/			
	DRFT:	/			
	THIRD ANGLE PROJECTION		DRAWING NO.:		/
		NAME:		NINGBO DEGSON ELECTRICAL CO., LTD	
		TITLE:		CUSTOMER DRAWING	
		REV		DO	
		SHEET		1/1	
		SCALE		1:1	